

10

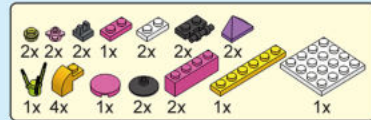

11

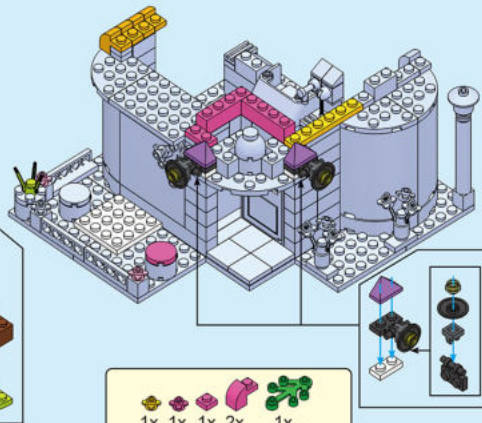

12

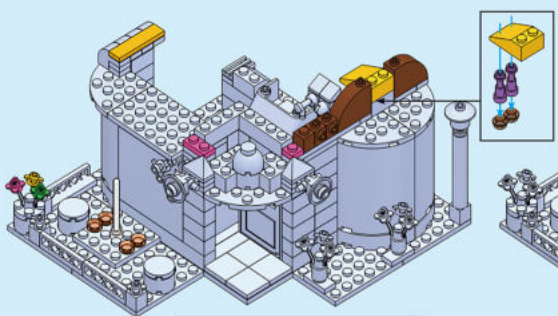

13

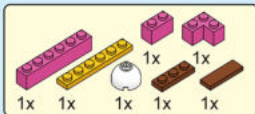
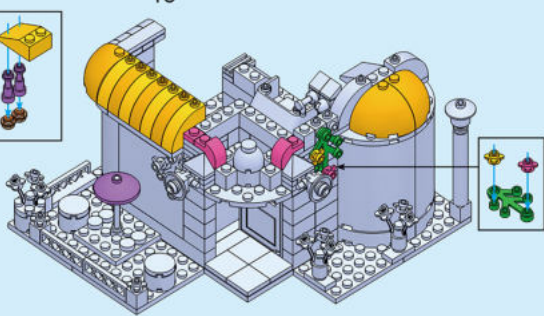

14

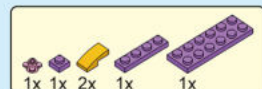
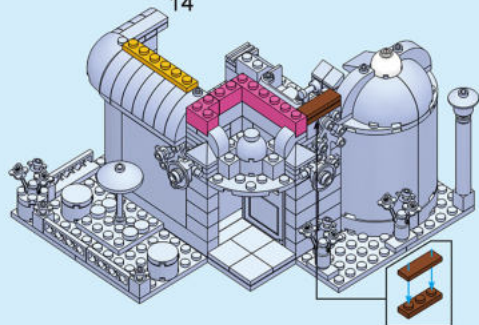

15

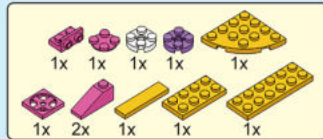
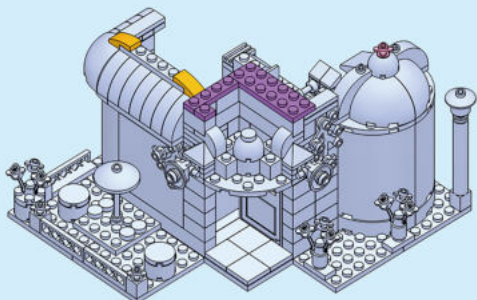

16

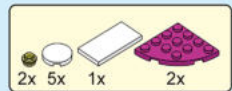
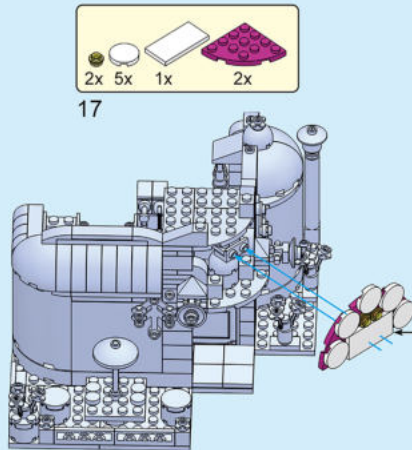

17

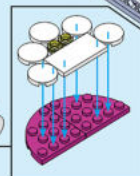
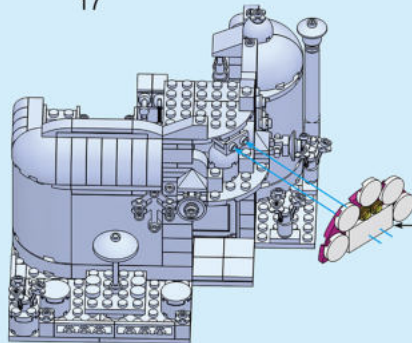

18

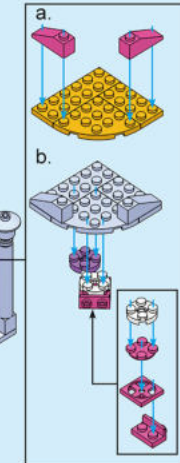
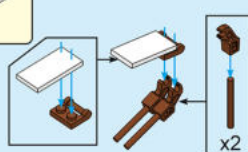

1



4

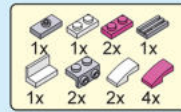
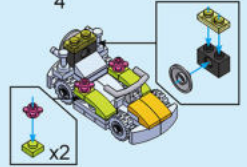

2

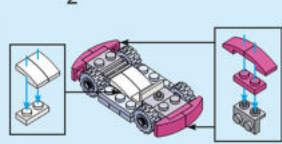

3

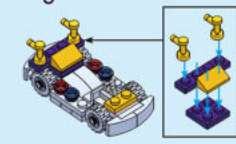

1

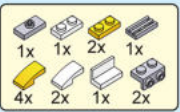
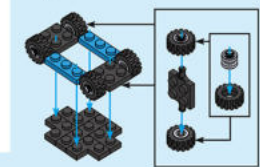

2

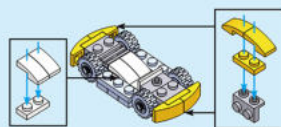

3

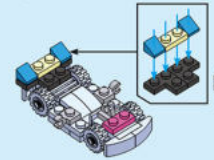

4

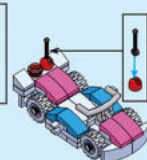

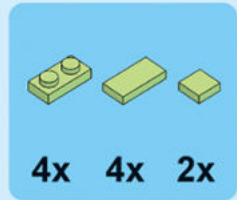
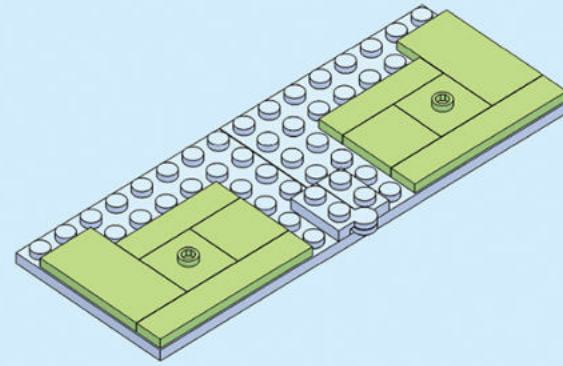
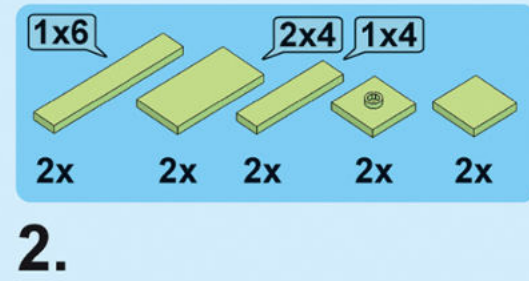
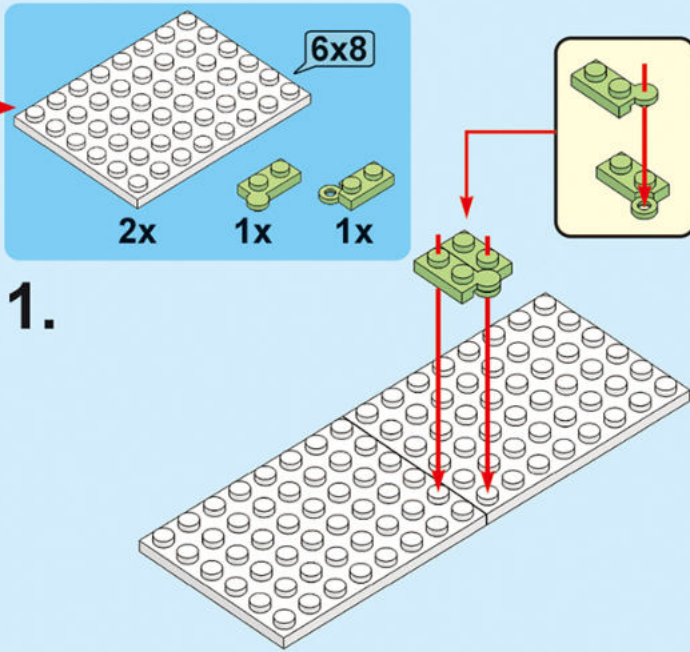

3.

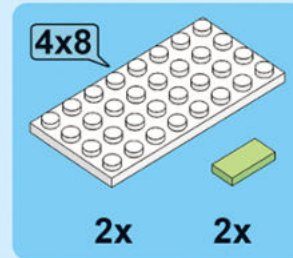
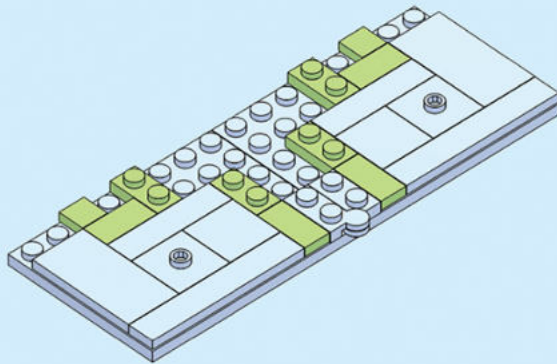

4.

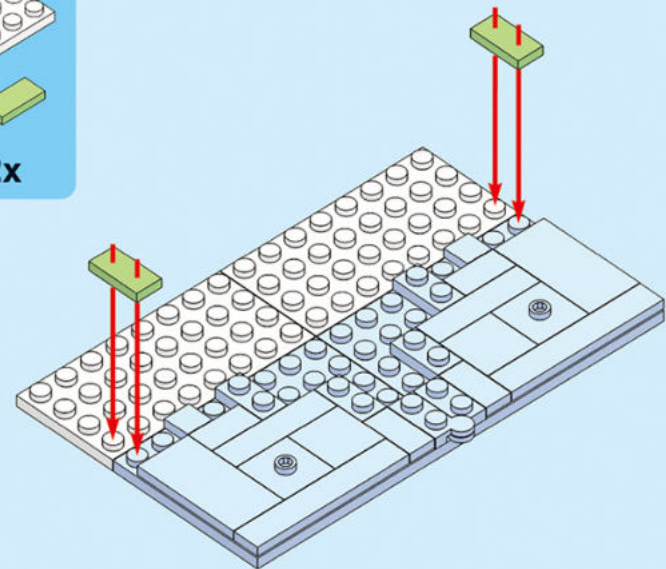

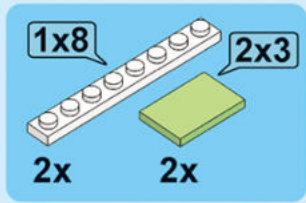

5.

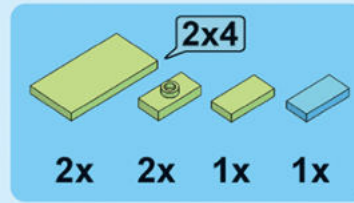
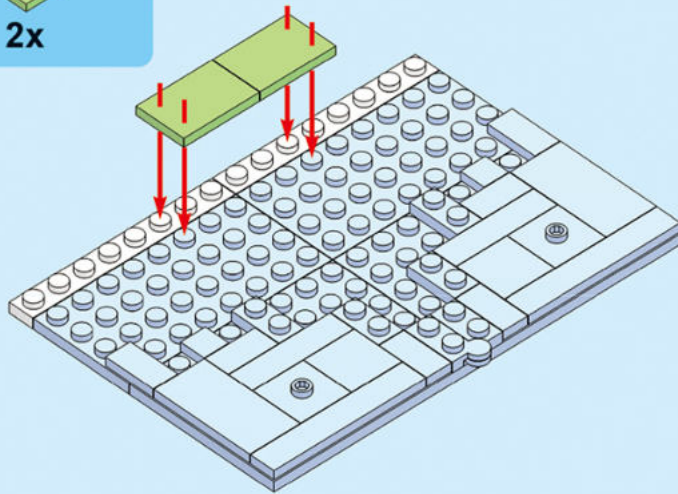

6.

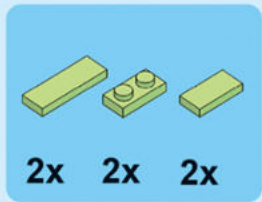
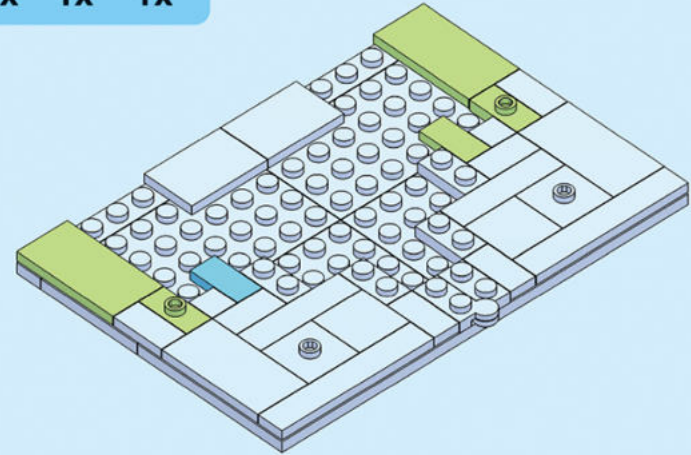

7.

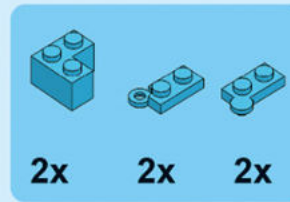
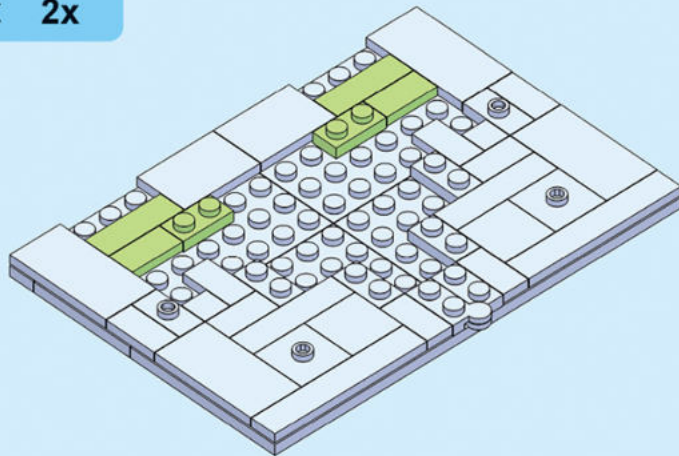

8.

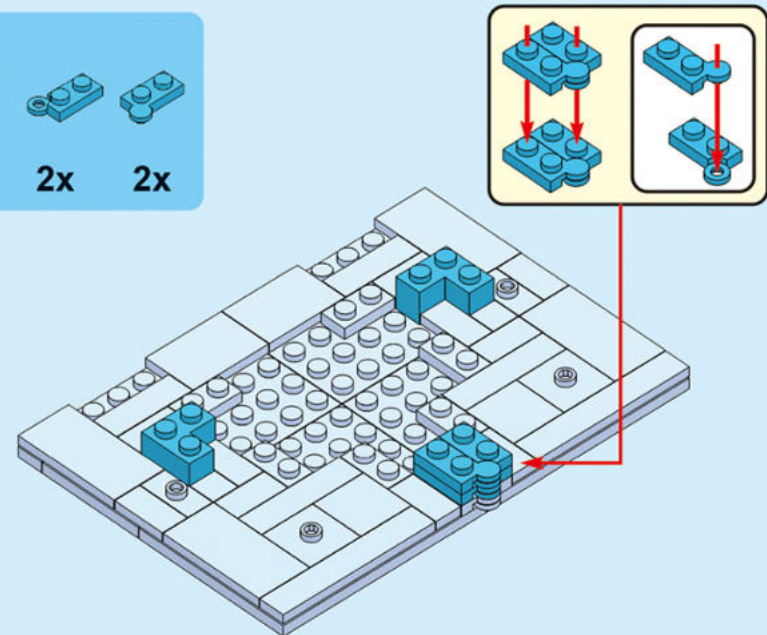

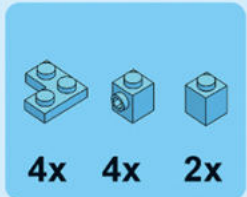

9.

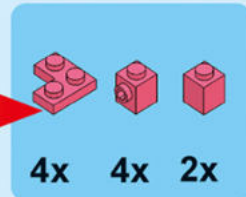
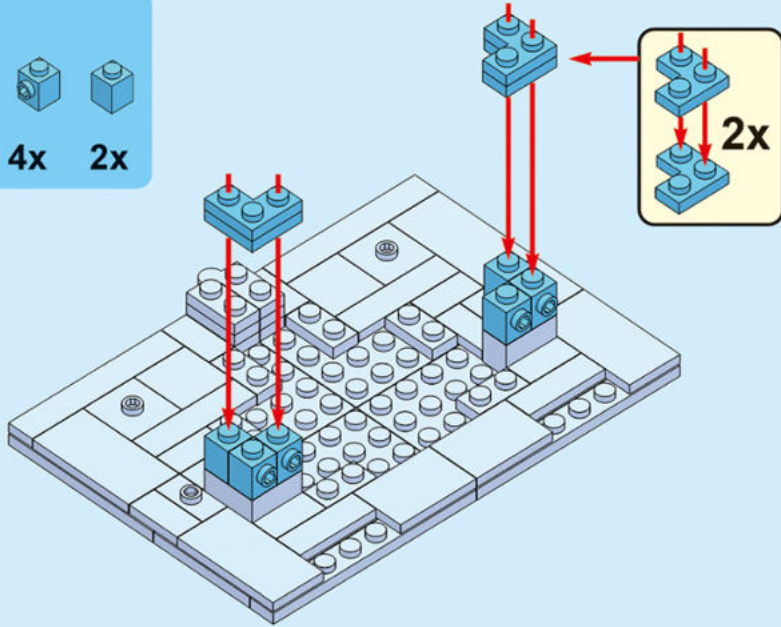

10.

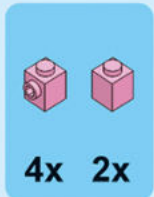
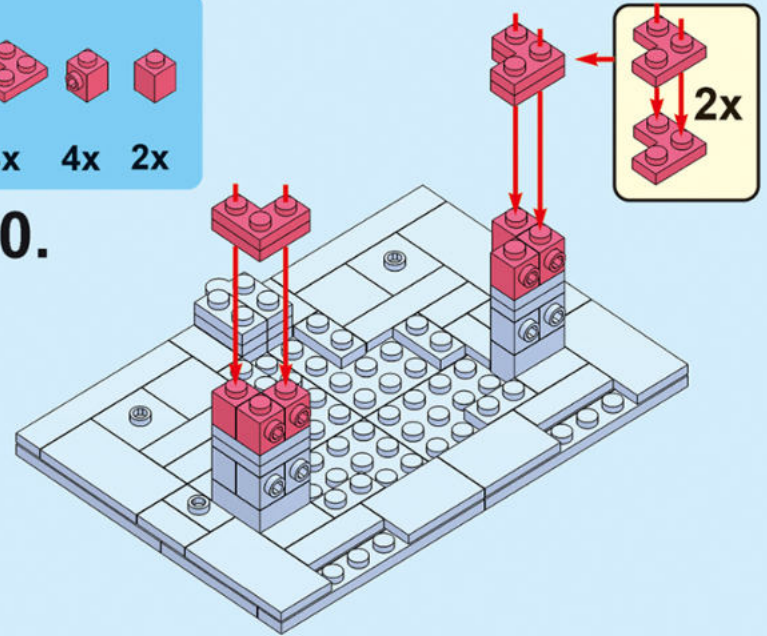

11.

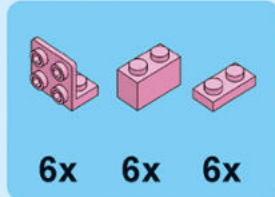
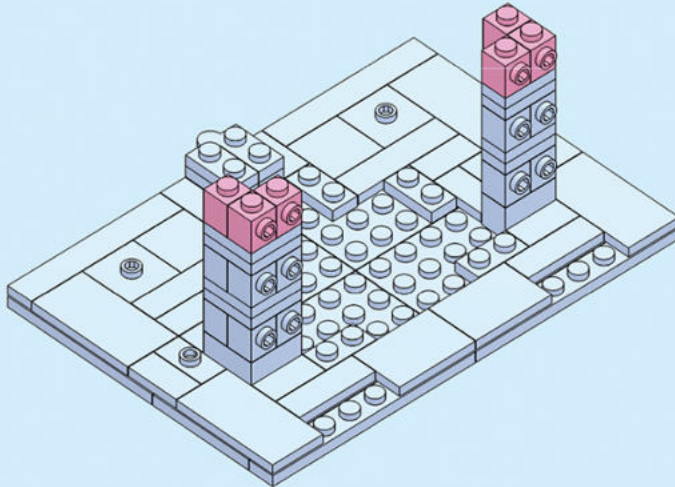

12.

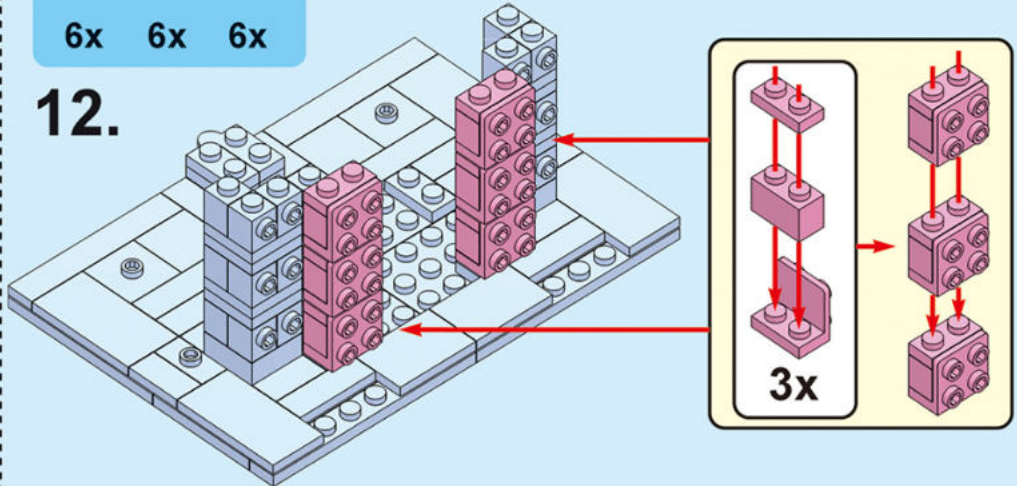

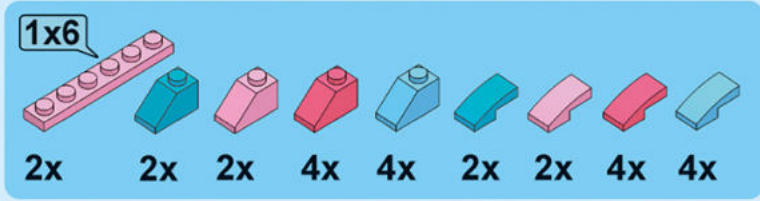

13.

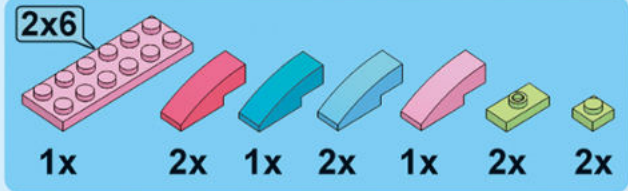
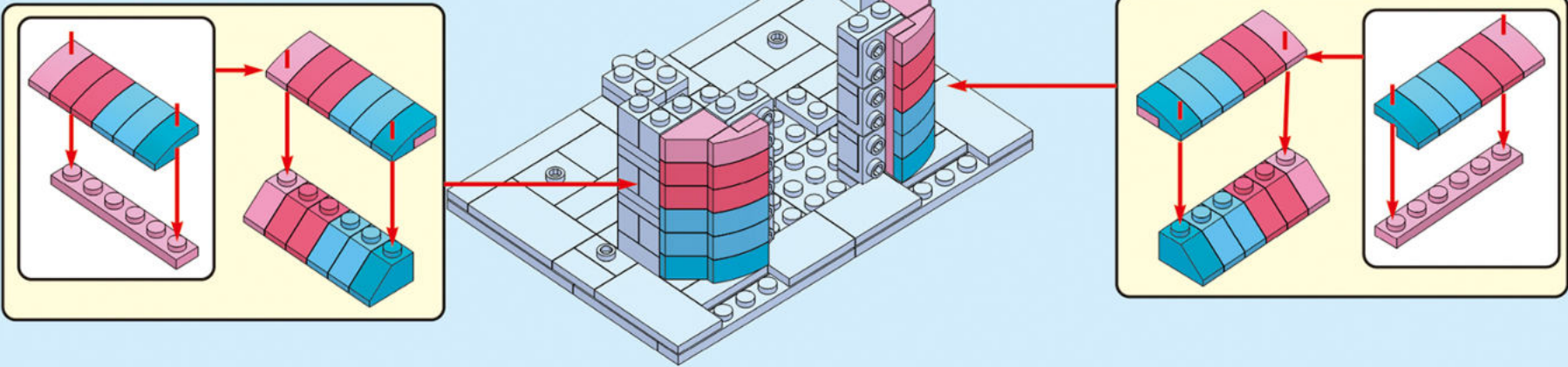

14.

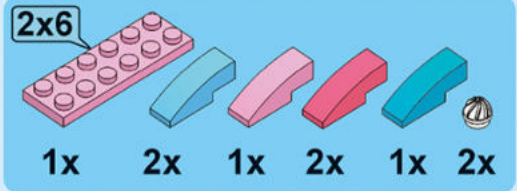
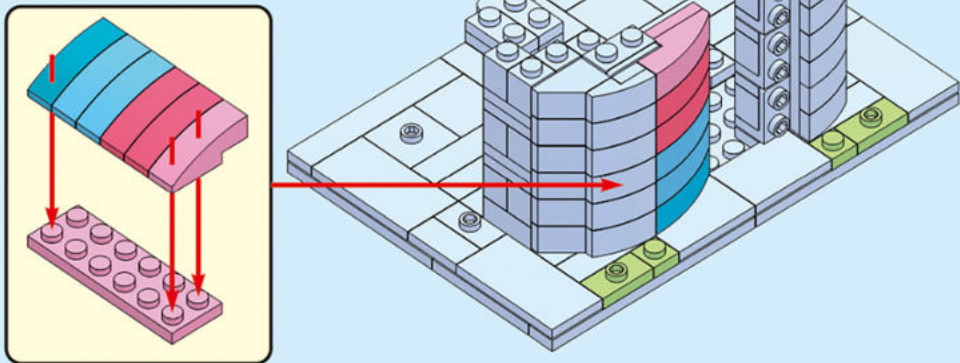

15.

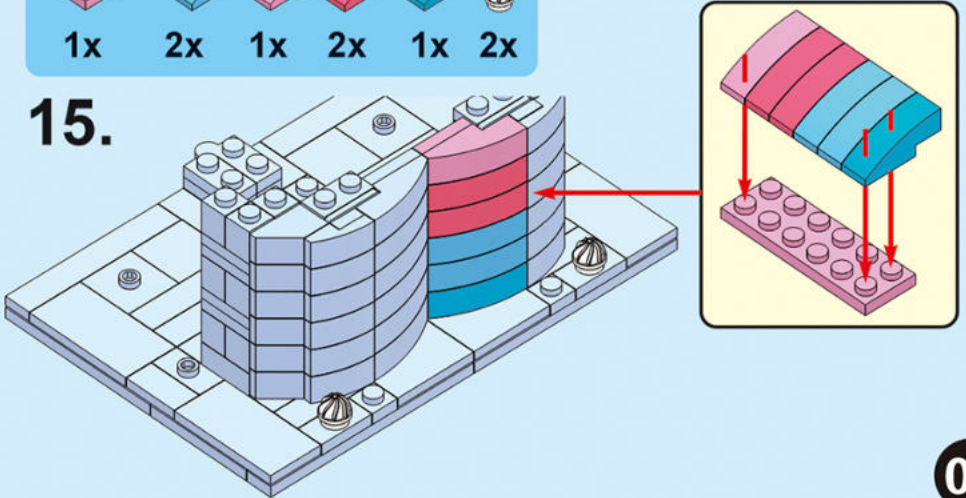



3

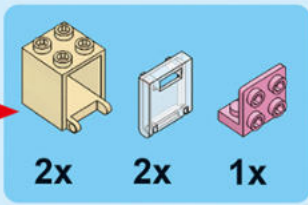

2x 2x 1x

16.

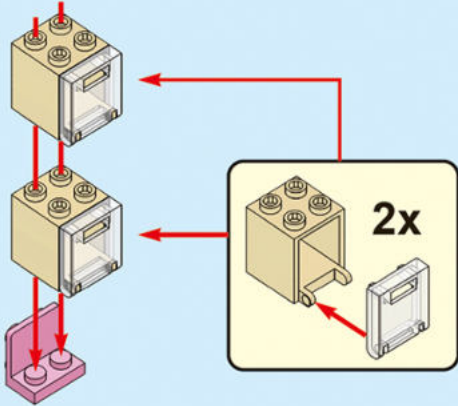

2x

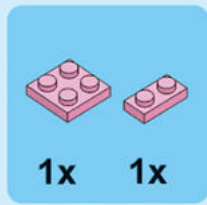

1x 1x

17.

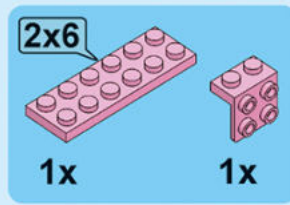
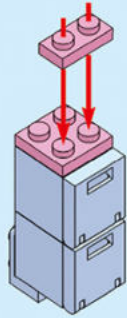

1x 1x

18.

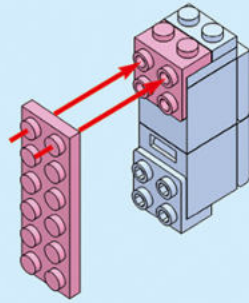

19.

18

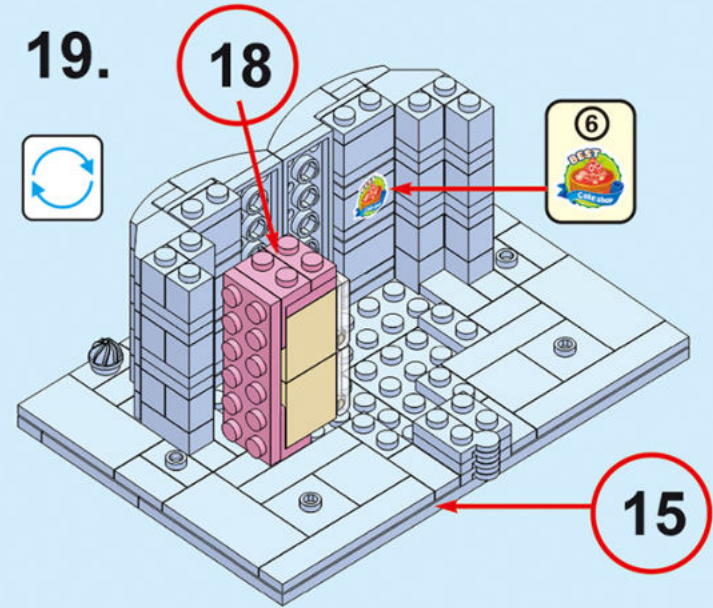

15

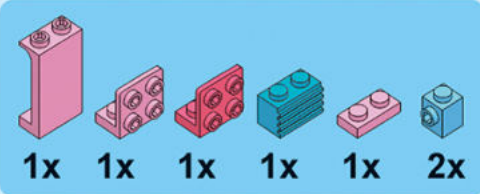

1x 1x 1x 1x 1x 2x

20.

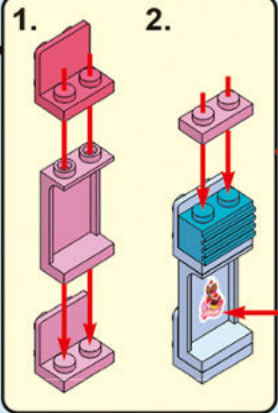

1.

2.

8

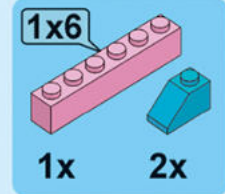
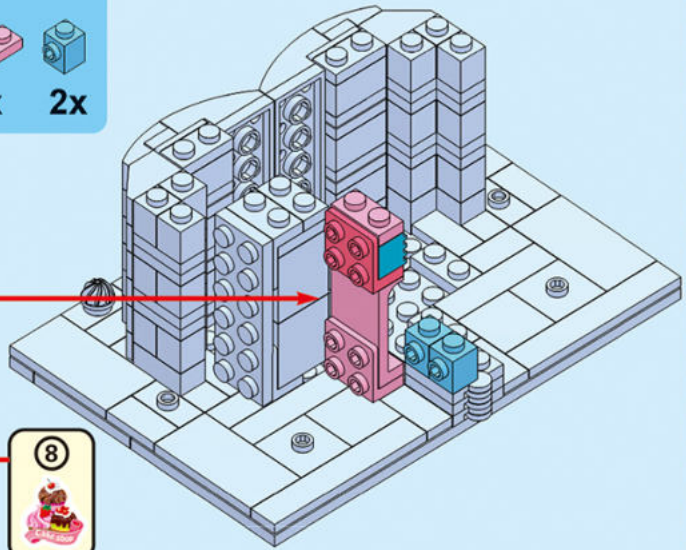

1x 2x

21.

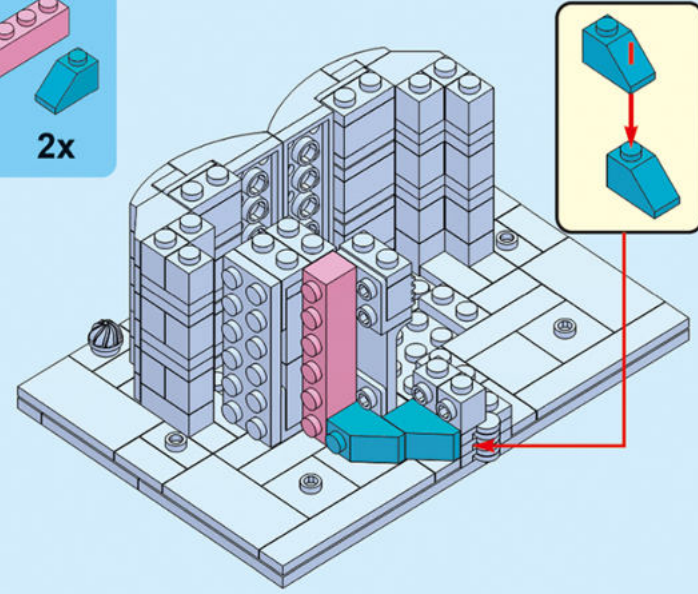

05

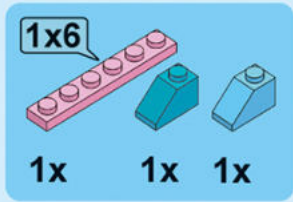

22.

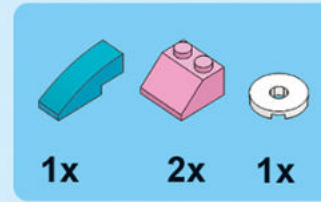
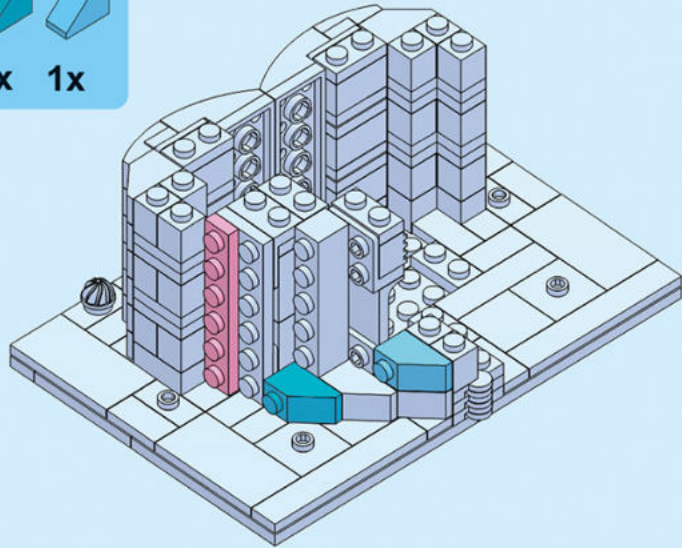

23.

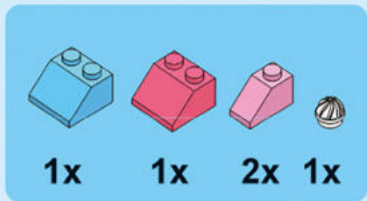
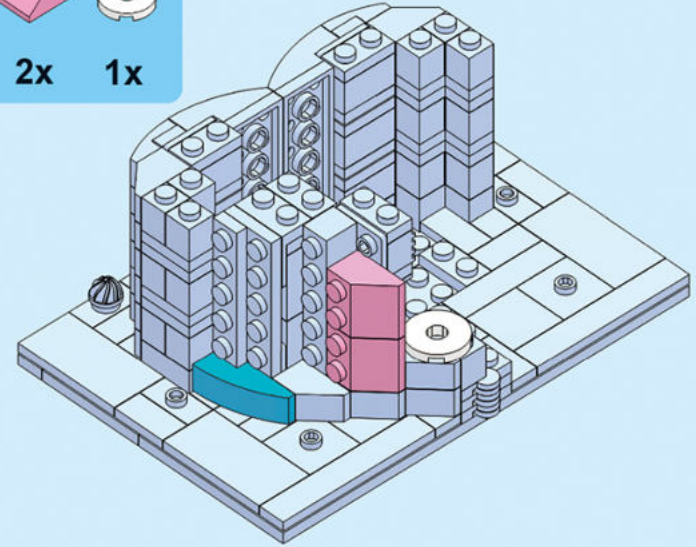

24.

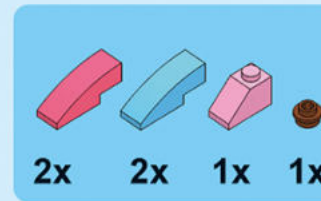
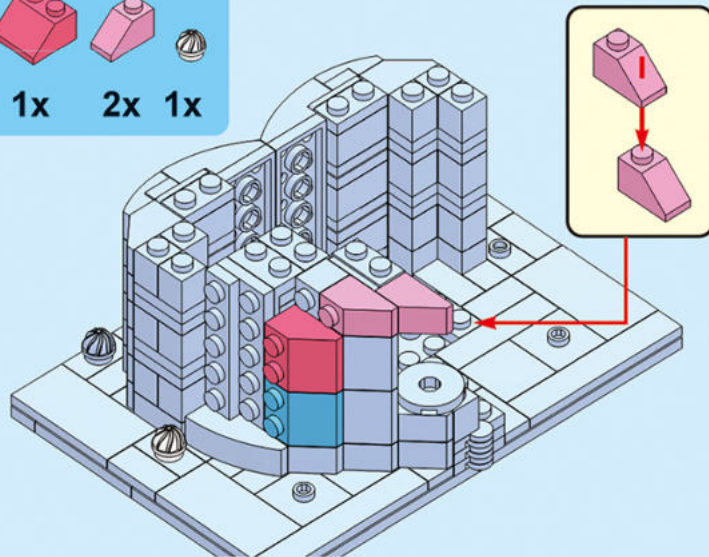

25.

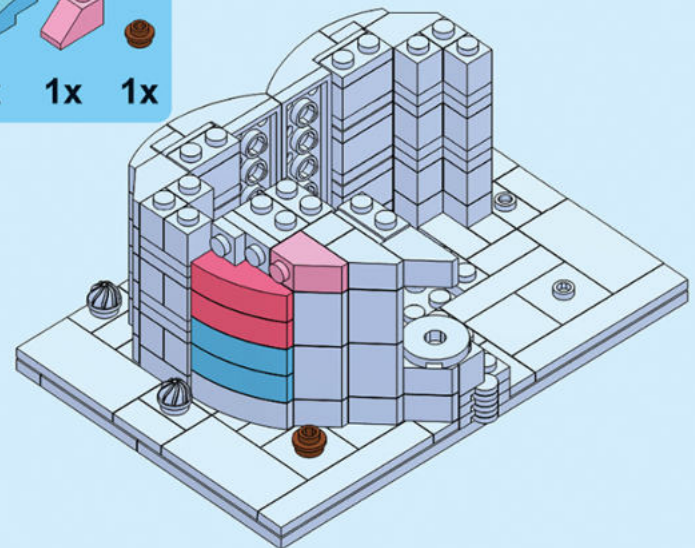

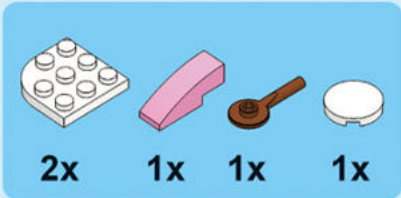

26.

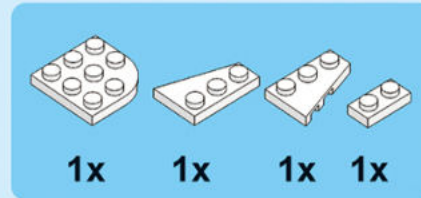
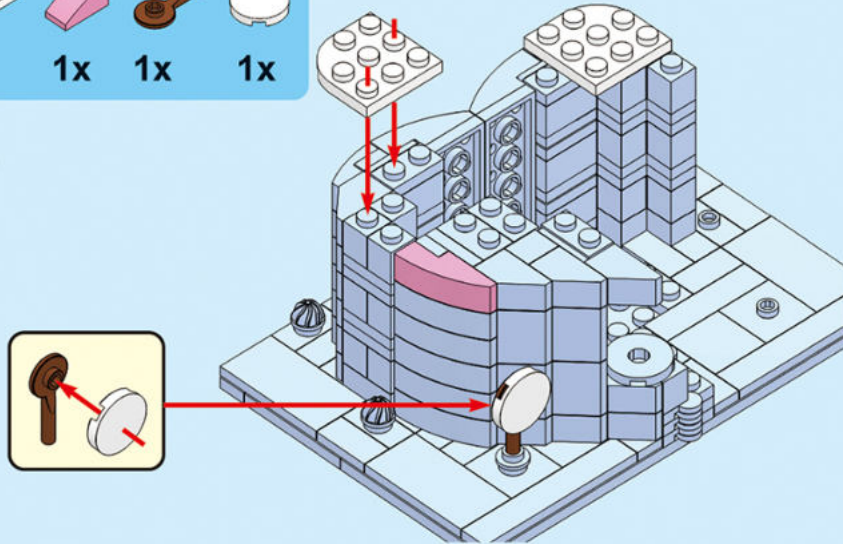

27.

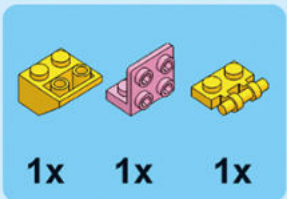
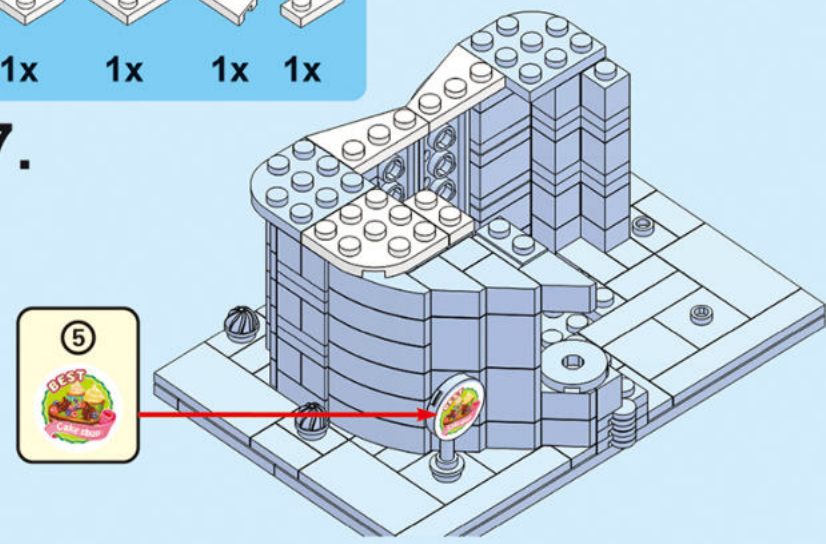

28.

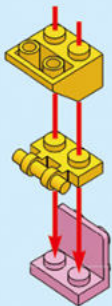

29.

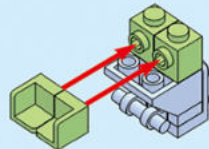

30.

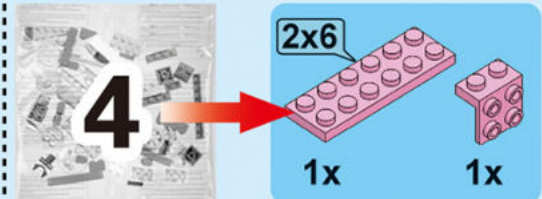
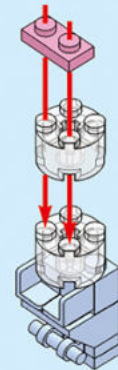

31.

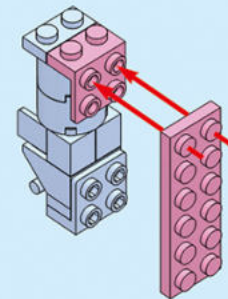

32.

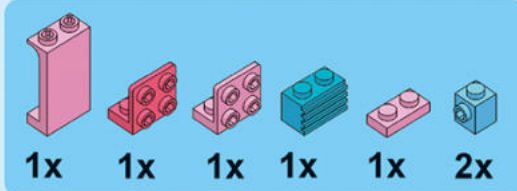
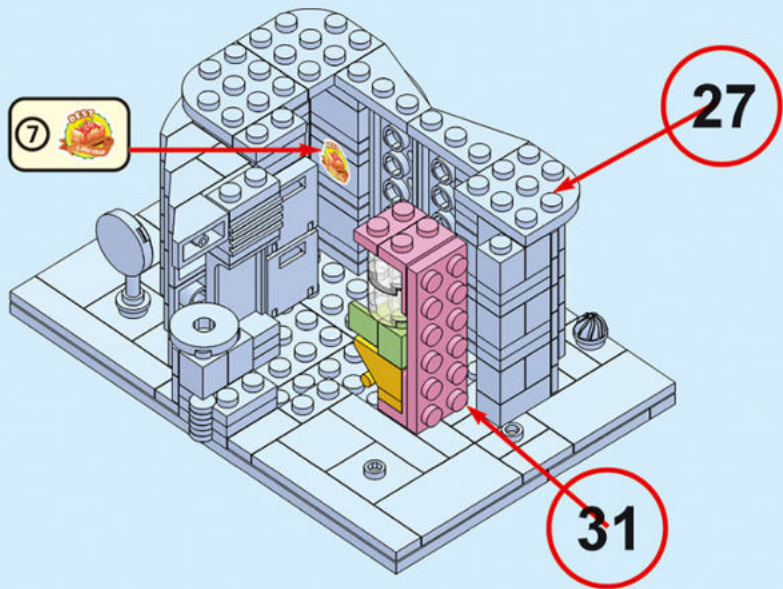

33.

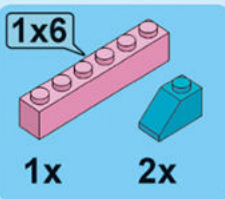
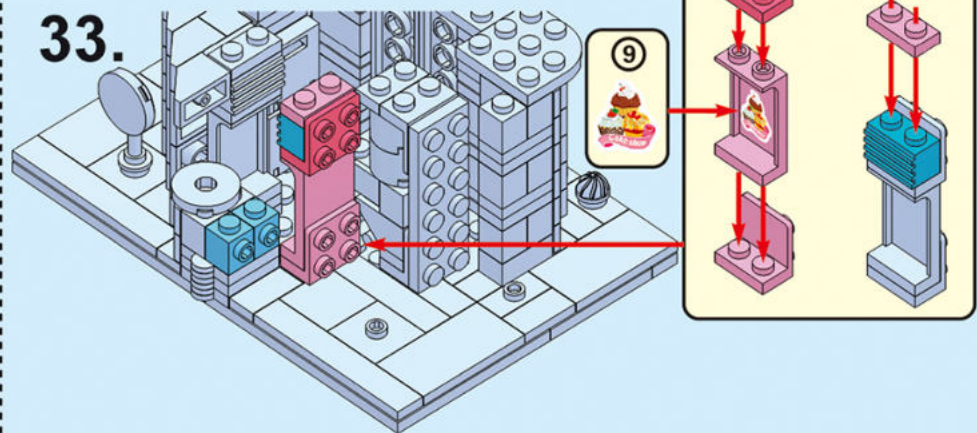

34.

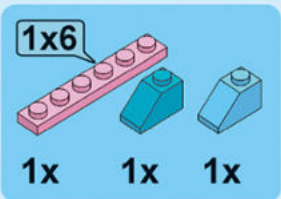
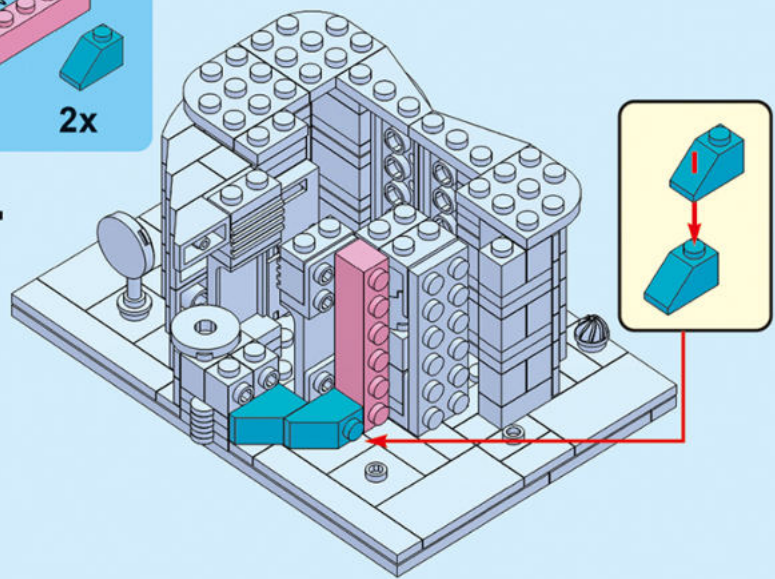

35.

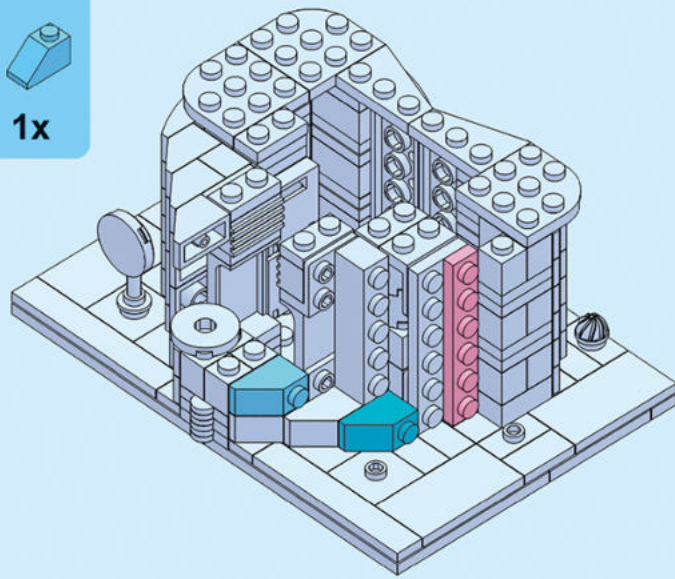

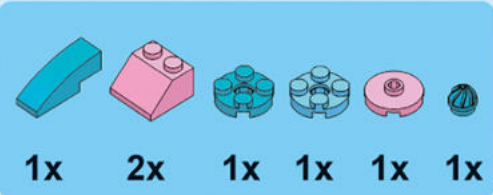

36.

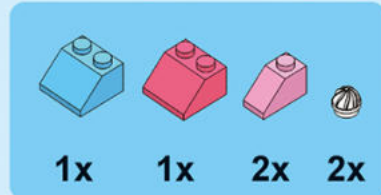
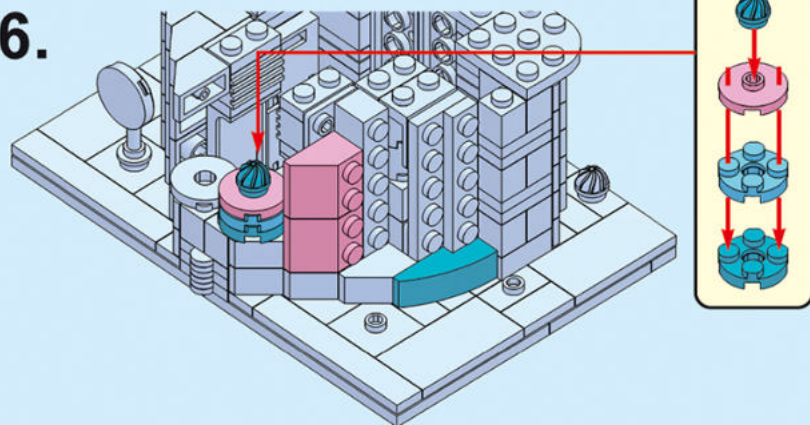

37.

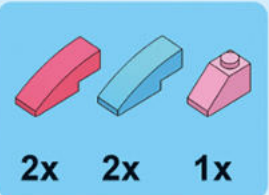
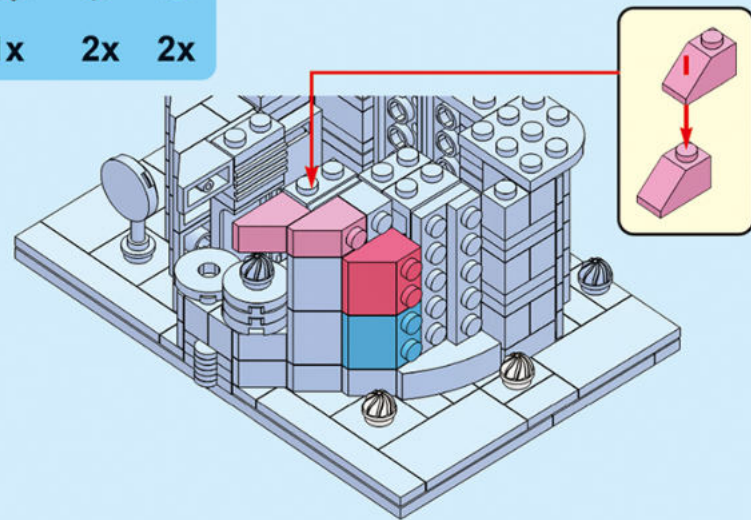

38.

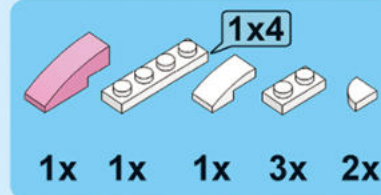
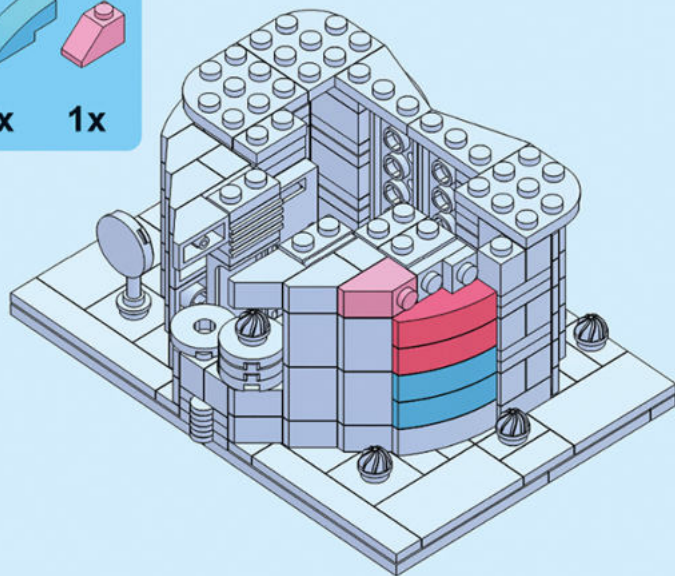

39.

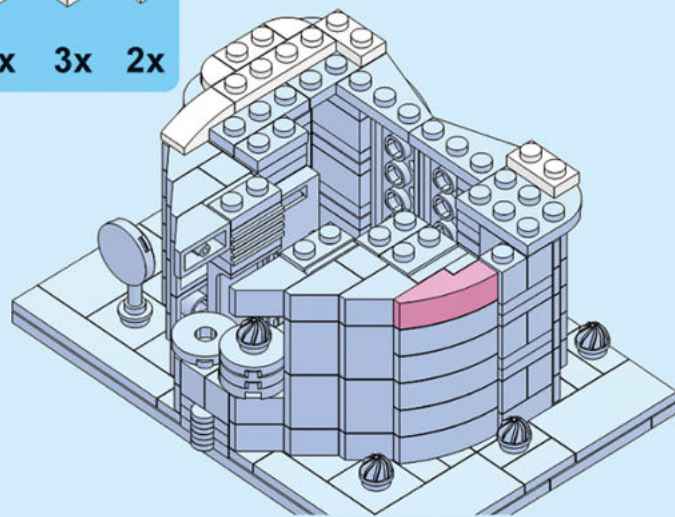

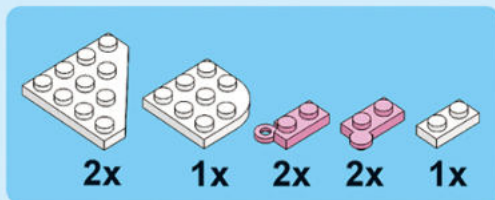

40.

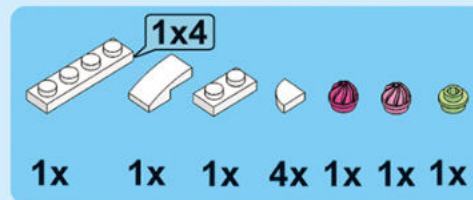
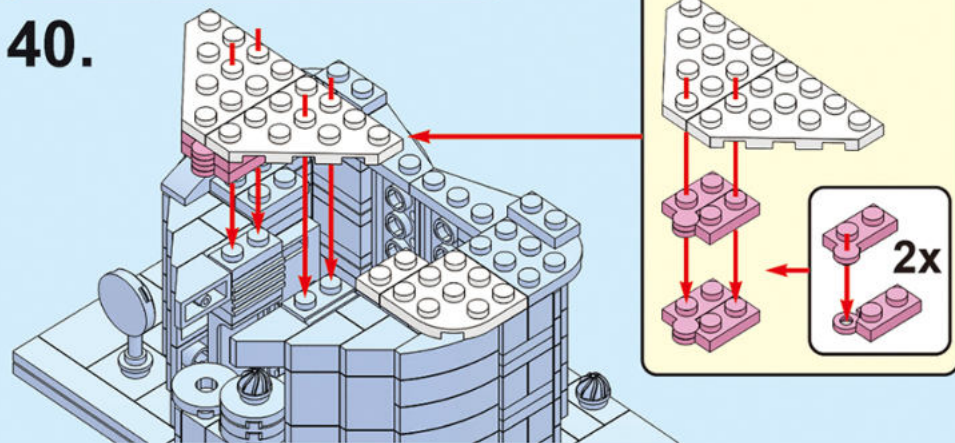

41.

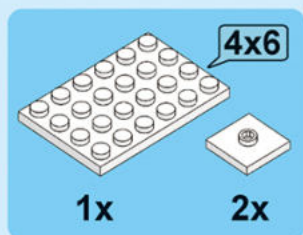
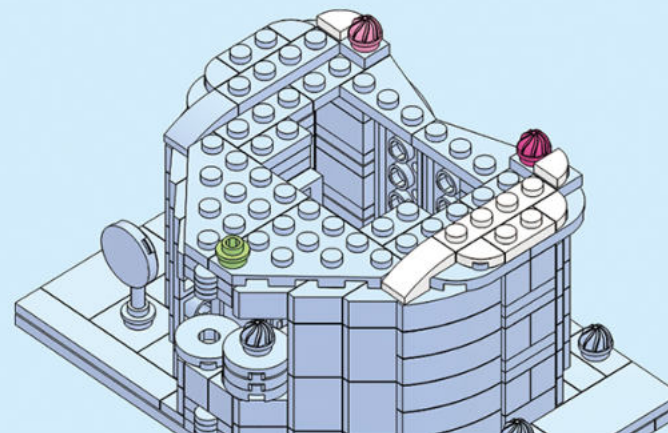

42.

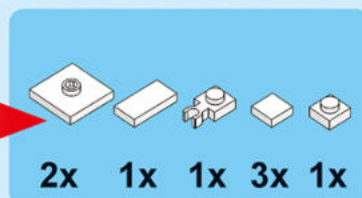
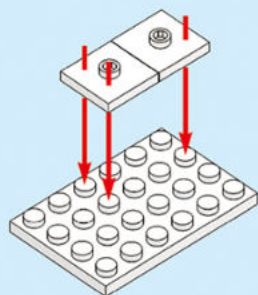

43.

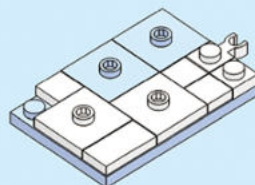

44.

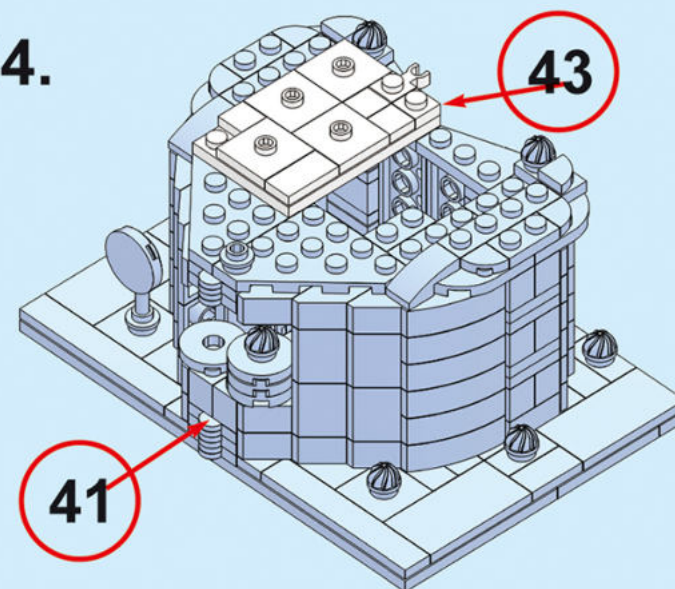

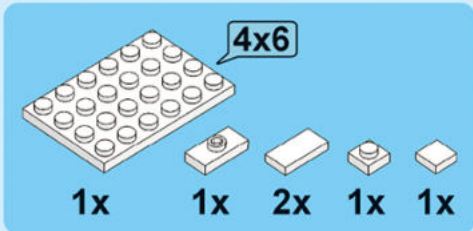

45.

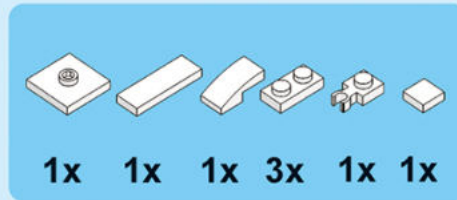
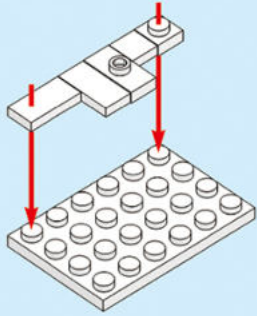

46.

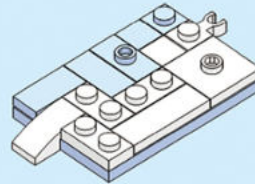

47.

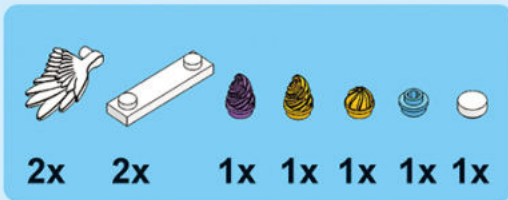
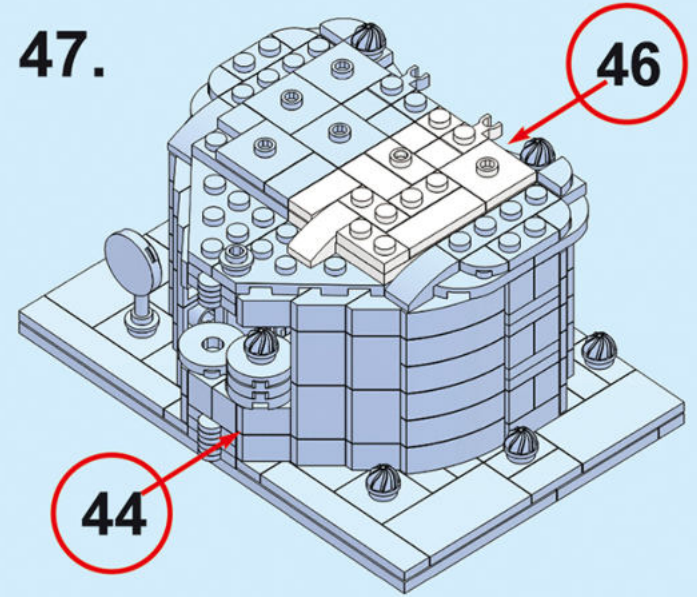

48.

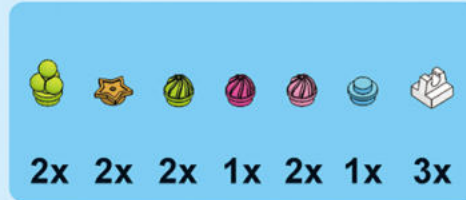
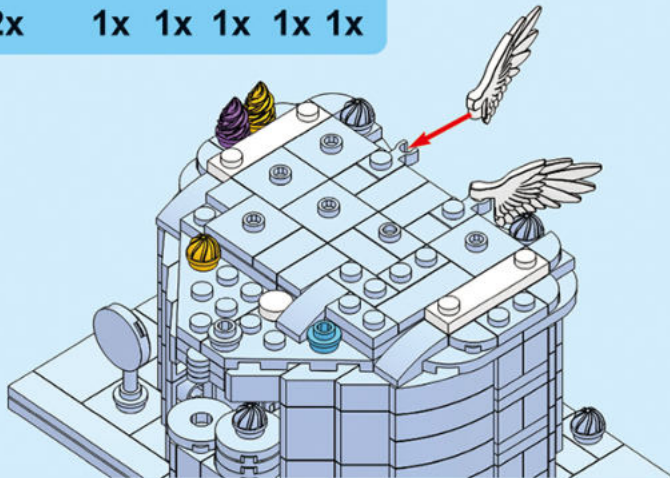

49.



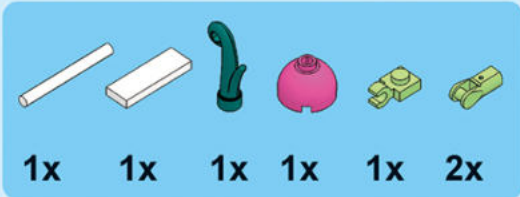

50.

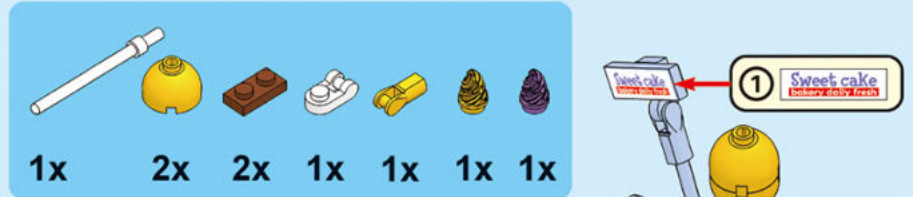
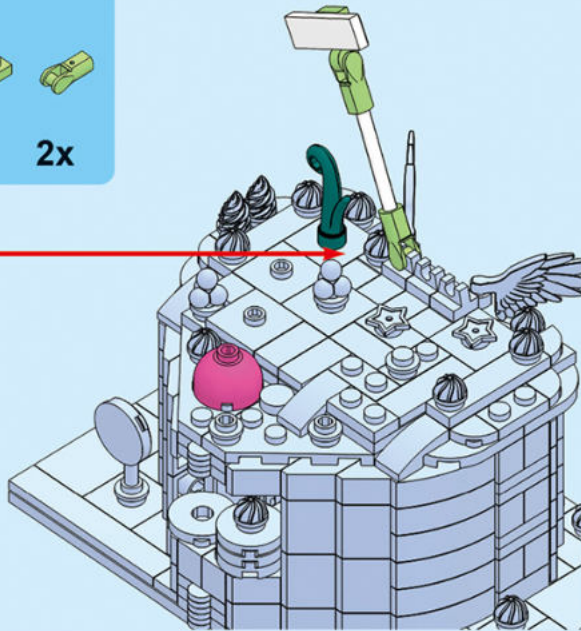
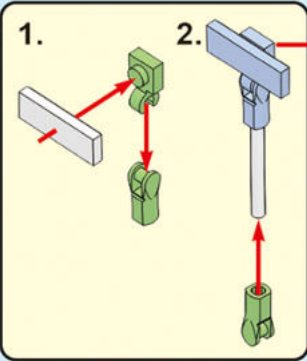

51.

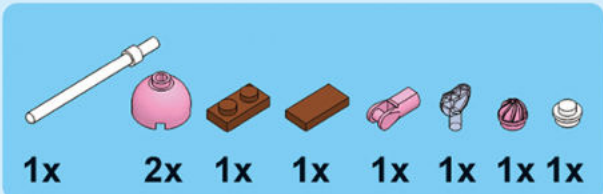
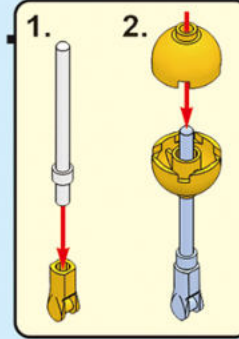

52.

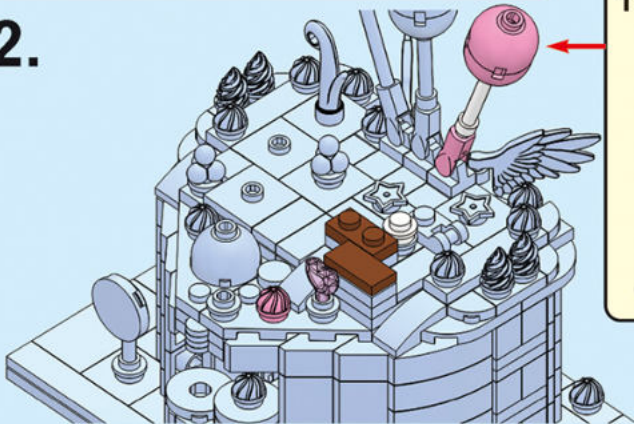
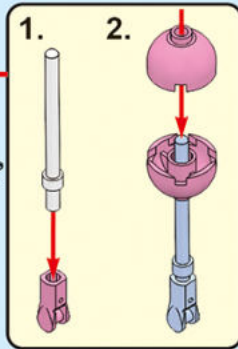

53.

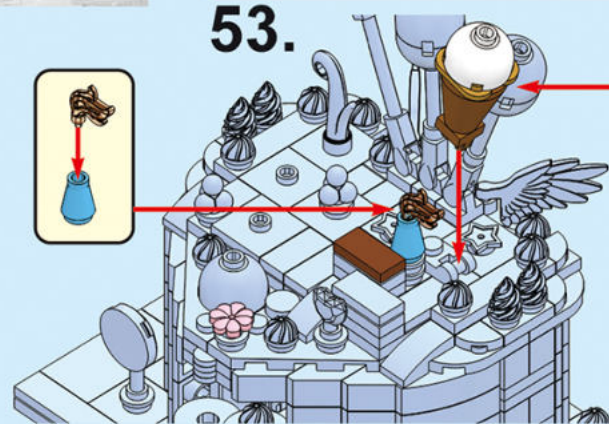
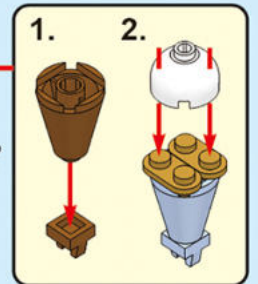

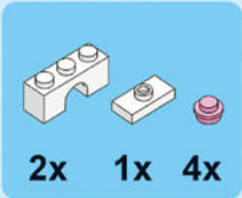

54.

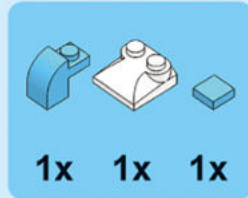
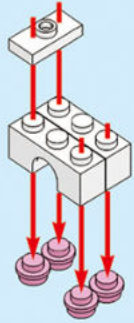

55.

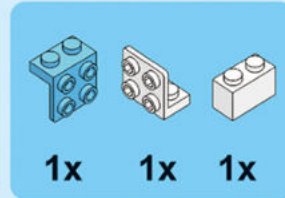
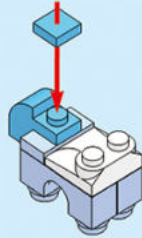

56.

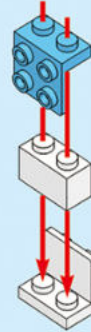

57.

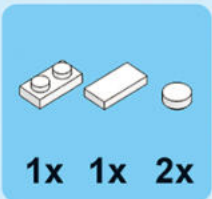
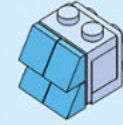

58.

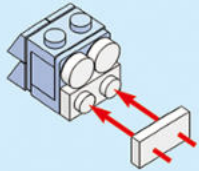

59.

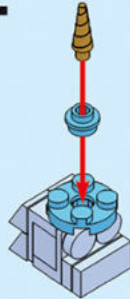

60.

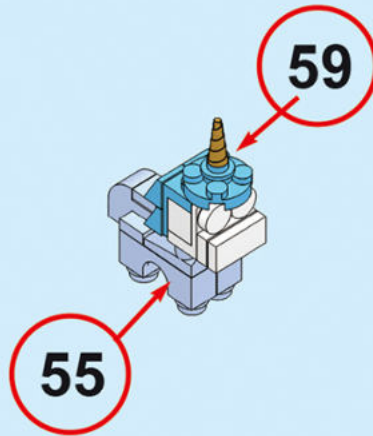

61.

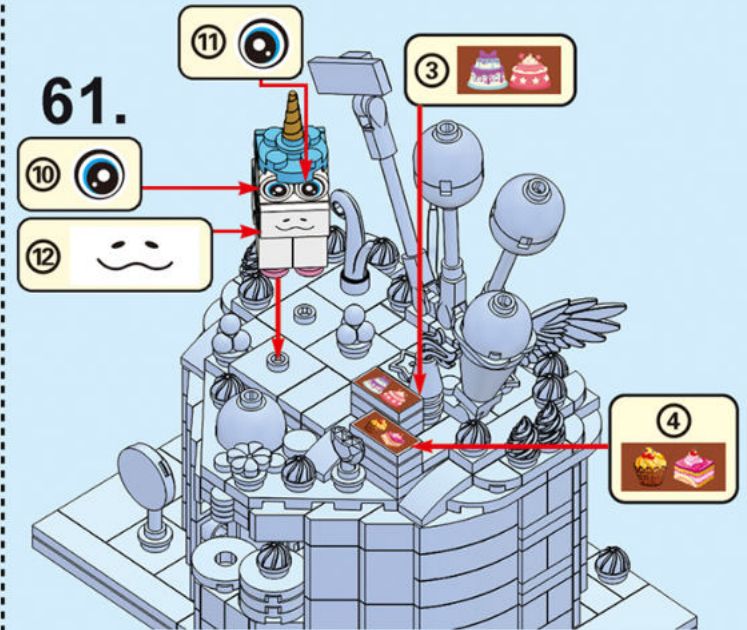

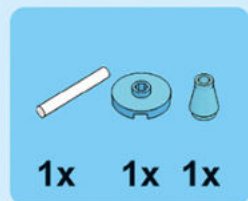
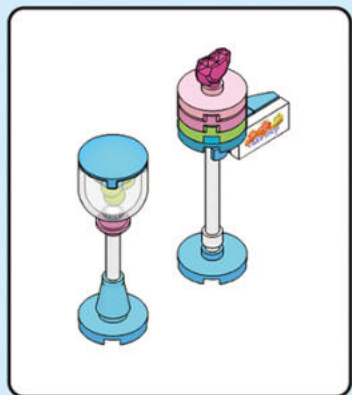

1.

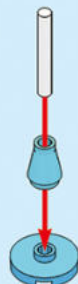

2.

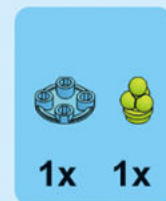

3.

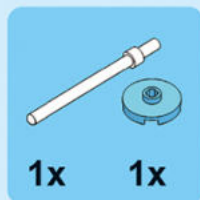
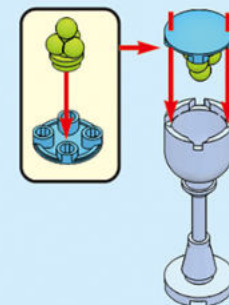

4.

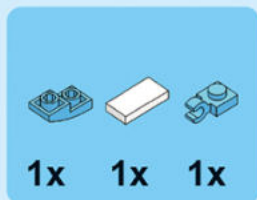
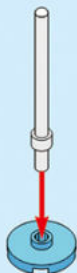

5.

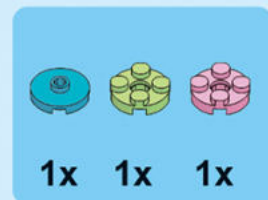
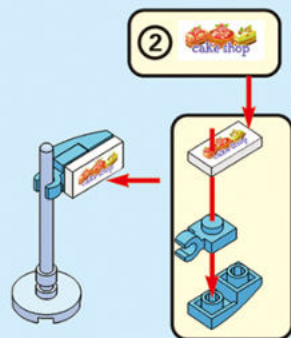

6.

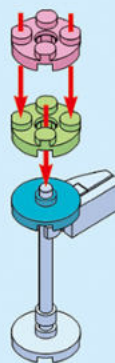

7.

