

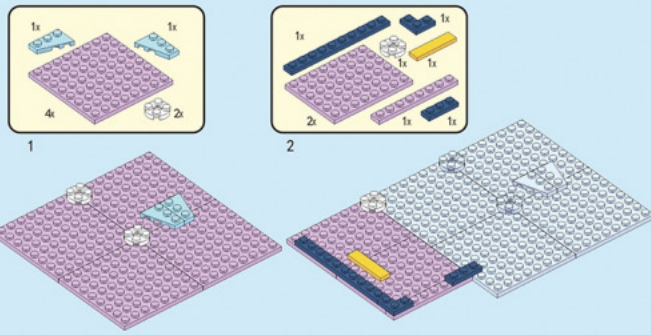

BACK

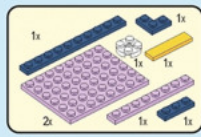

1



2

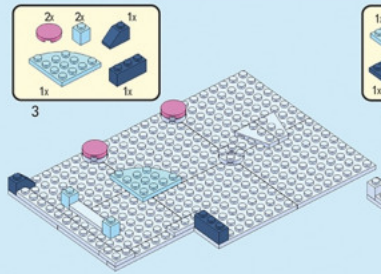

3

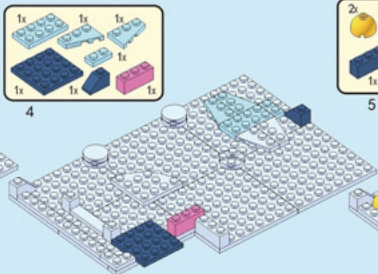

4

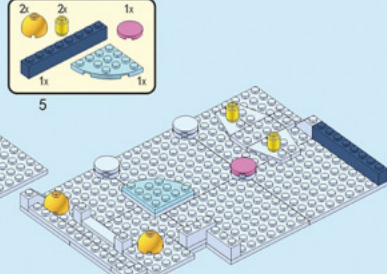

5

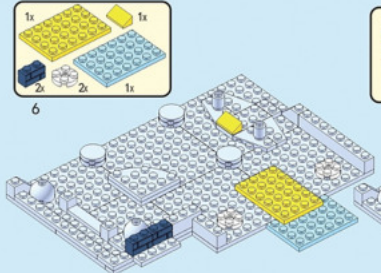

6

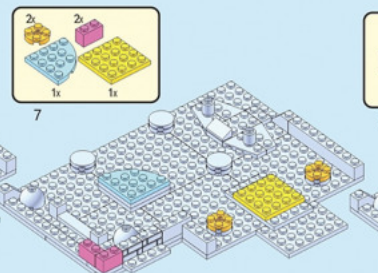

7

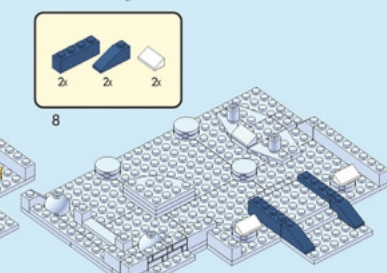

8

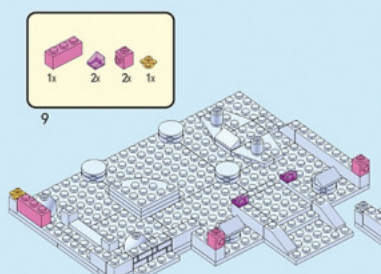

9

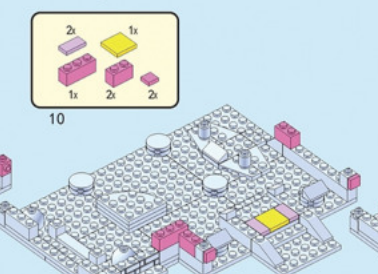

10

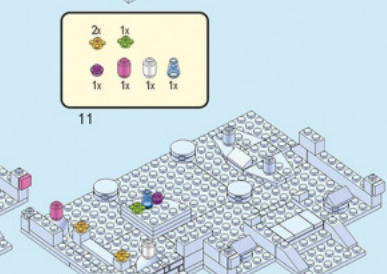

11

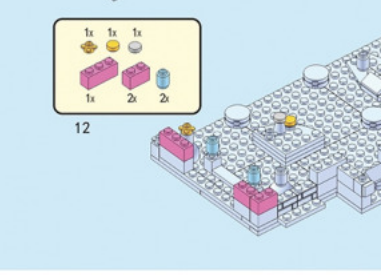

12

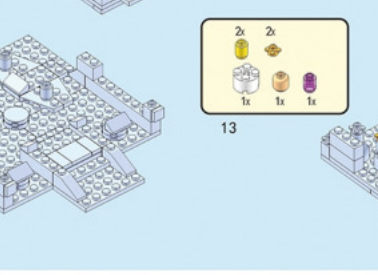

13



14

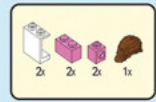

15

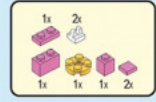

16



17



18



19

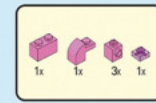

20

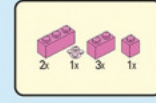

21

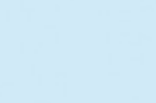

22



23



24

25

26

27
3x 3x

28
1x 5x

29
2x 4x

30
2x 4x 1x

31
1x 1x 3x 1x

32
2x 1x 1x 1x

33
1x 3x 3x

34
2x 1x 1x 2x 1x

35
1x 1x 2x 2x 1x

36
2x 2x 1x 2x

37
1x 2x 2x 2x

38
1x 4x 1x 1x

39
1x 1x 2x 1x 1x

40
1x 1x 2x 1x 1x

41
4x 1x 1x

42
1x 1x 2x 1x 1x

43
2x 1x 1x 1x

44
1x 2x 3x

45
1x 1x 1x 2x

46
2x 1x 1x 1x 1x

47
1x 2x 2x 1x

48
1x 1x 1x 2x 1x

49
1x 1x 1x 2x

50
1x 2x 2x 1x

51
2x 2x 2x 2x

52
2x 2x 2x 2x

53
2x 2x 2x 2x

54
1x 1x 1x

55
1x 2x 2x

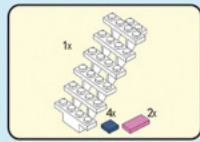

56



57



58

59

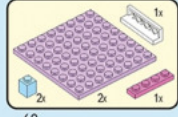

60

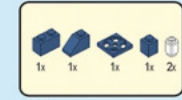

61

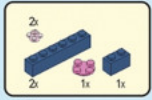

62

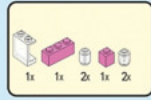

63

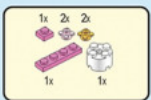

64

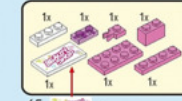

65



66

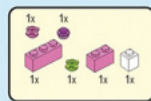

67

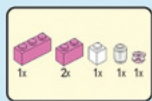

68



69

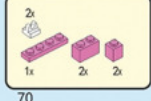

70



71



72



73

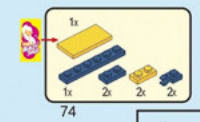

74

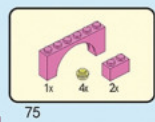

75

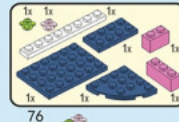

76

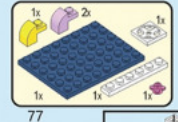

77

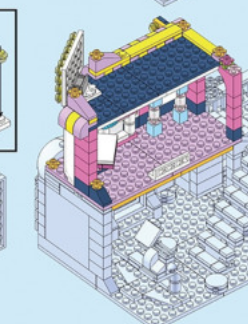
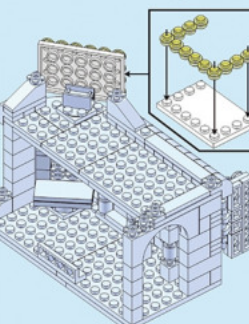
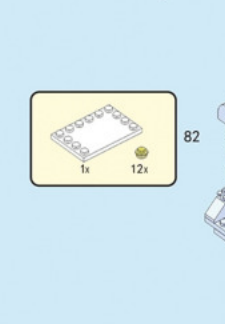
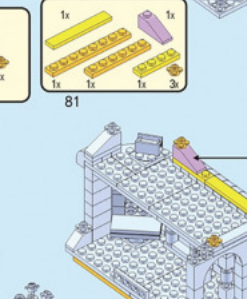
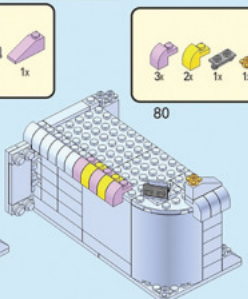
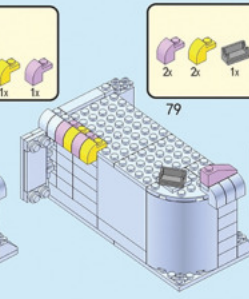
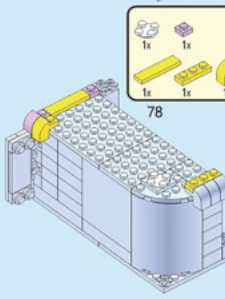
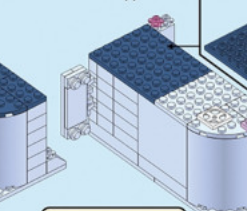
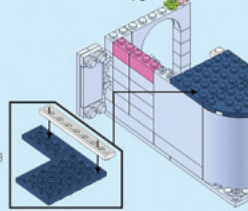
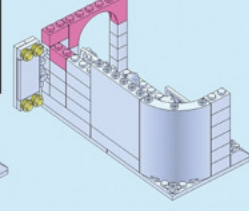
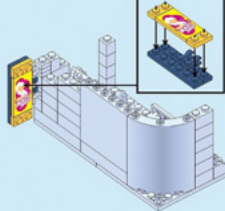

065-2

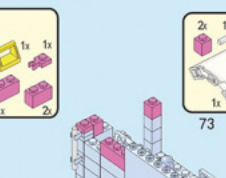
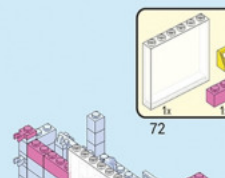
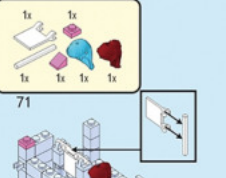
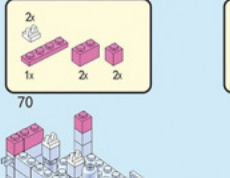
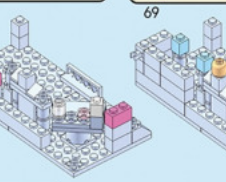
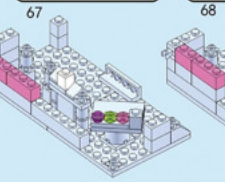
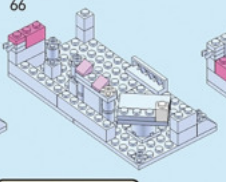
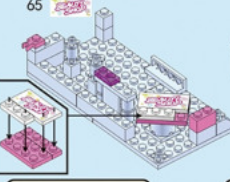

2

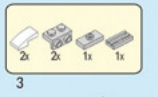

3



4



5



6

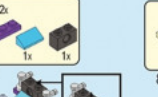

7



8

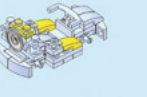
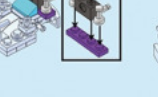

9



065-3



1



2



3



4



5

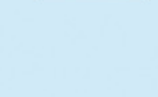
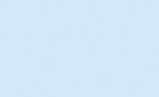
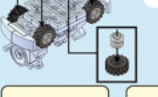

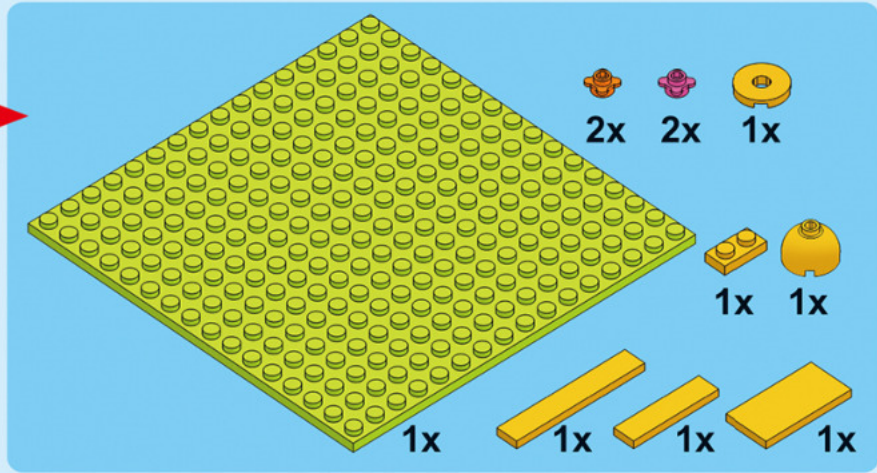

1.

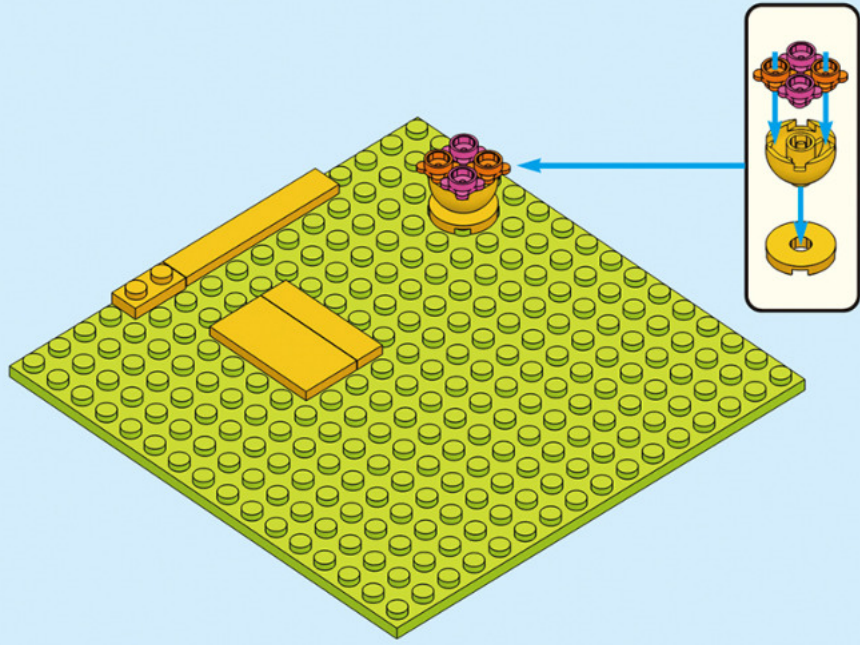

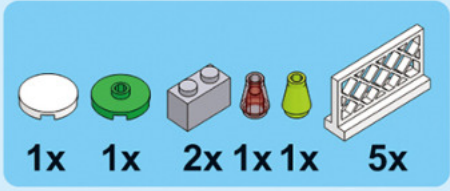

2.

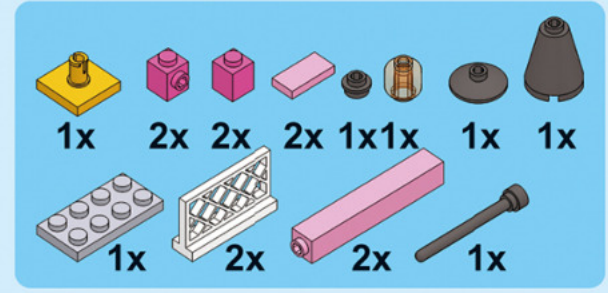
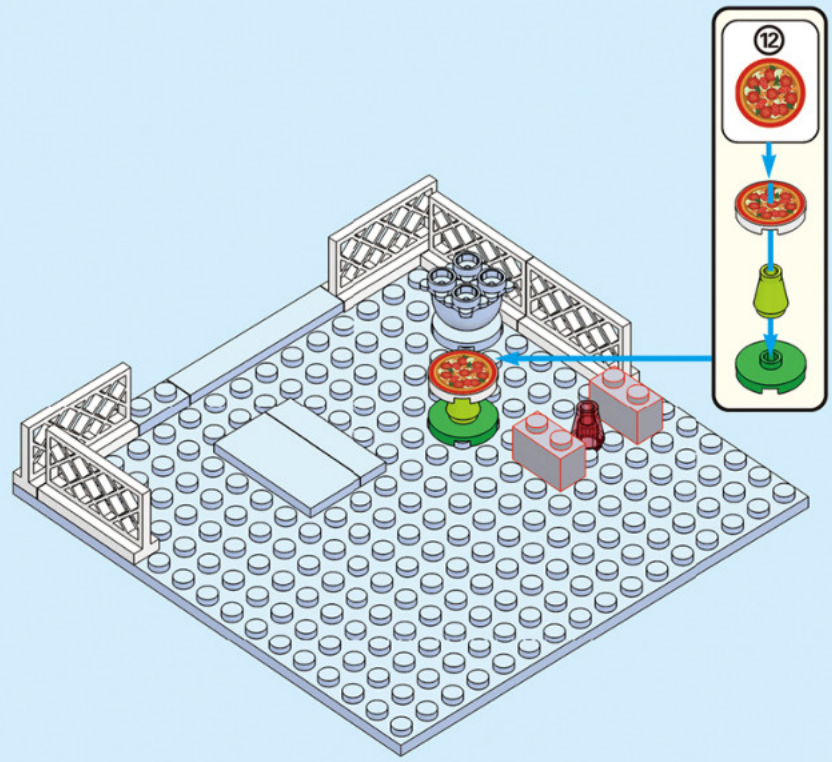

3.

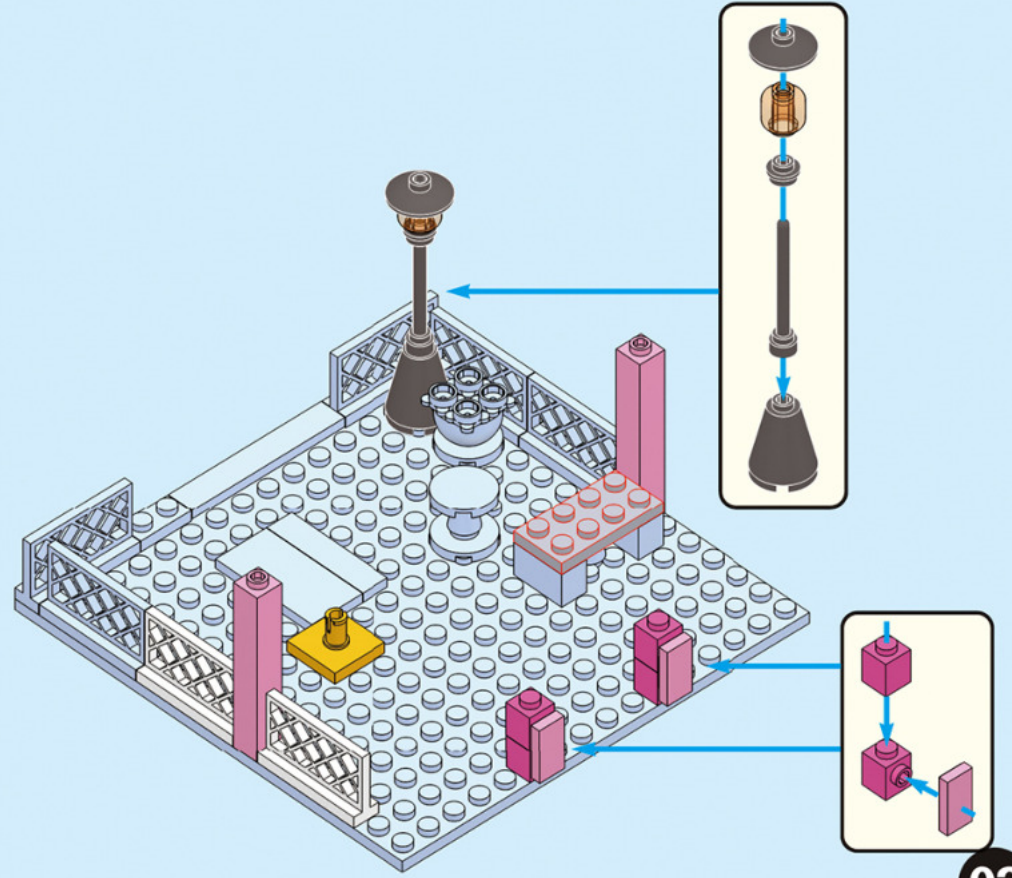

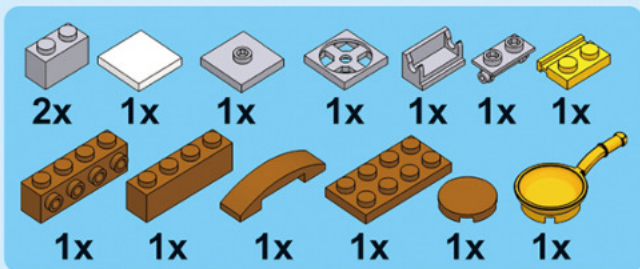

4.

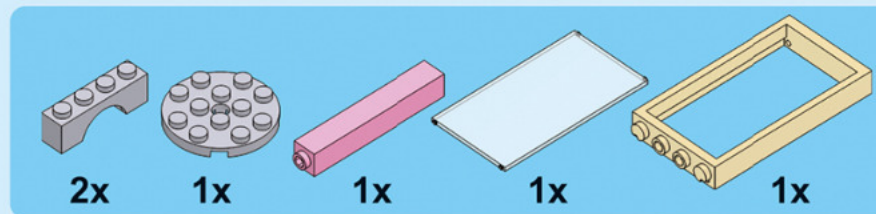
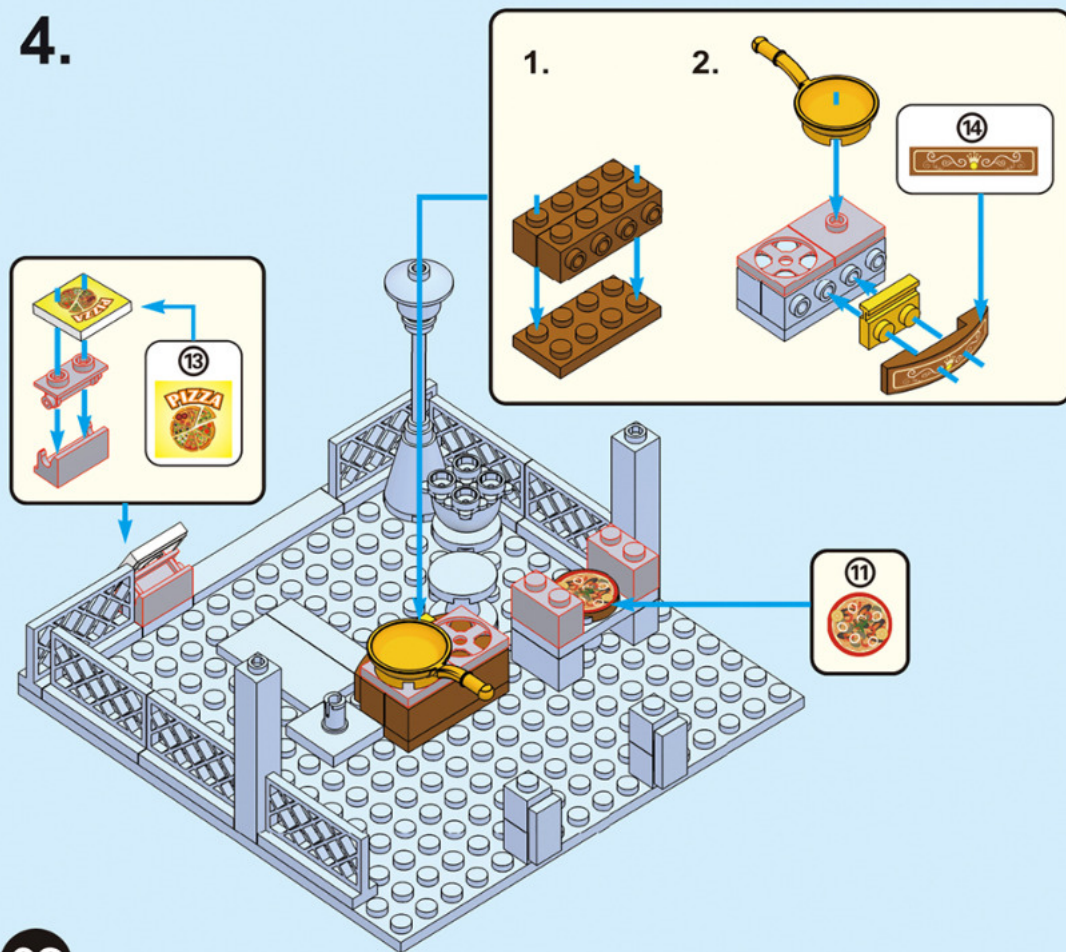

5.

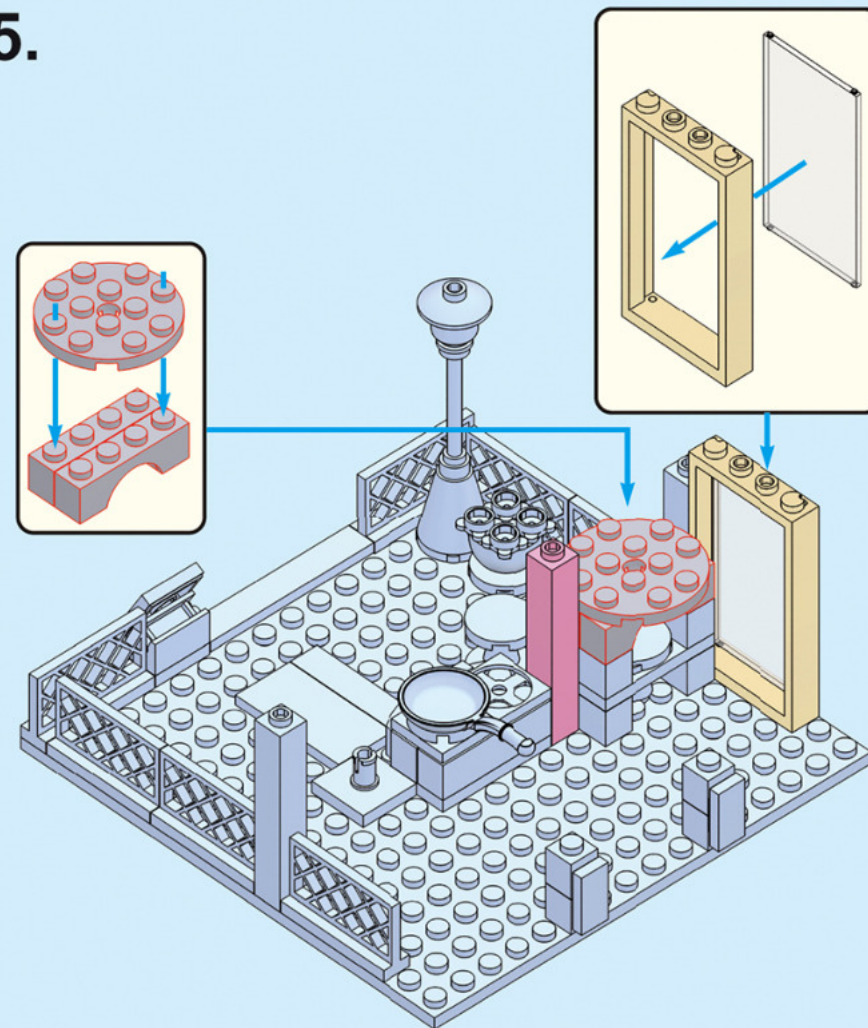

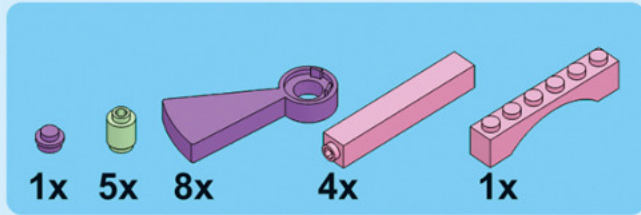

6.

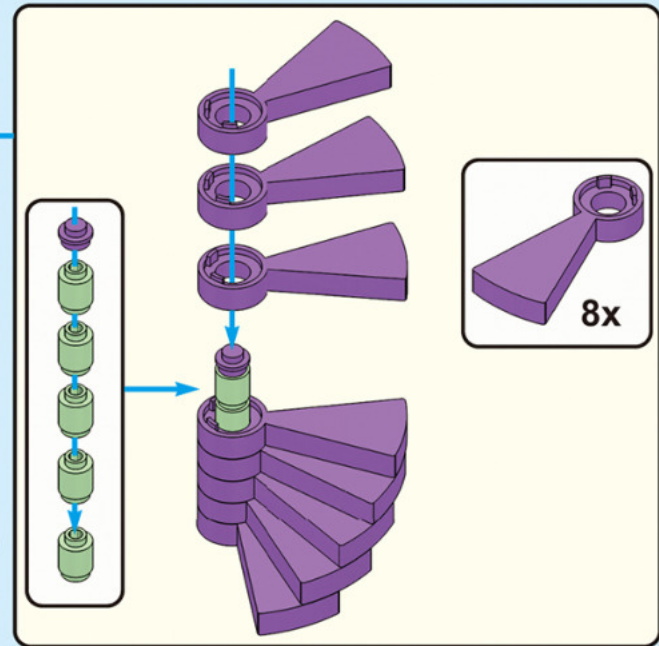
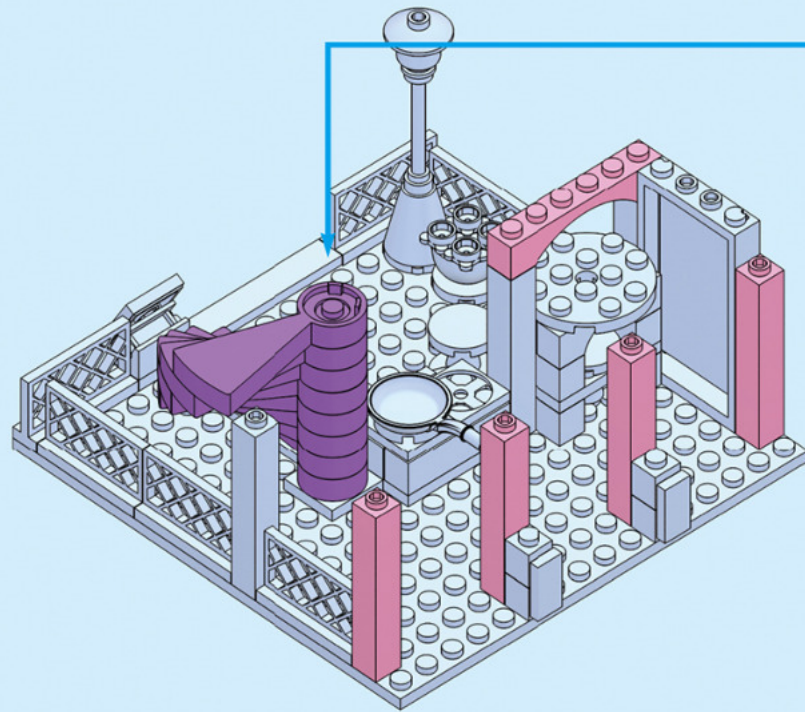

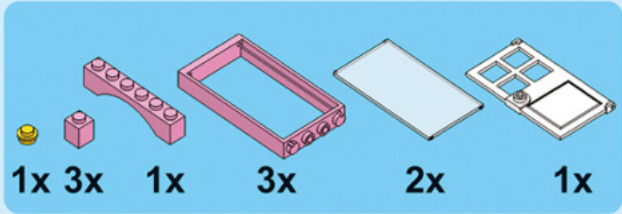

7.

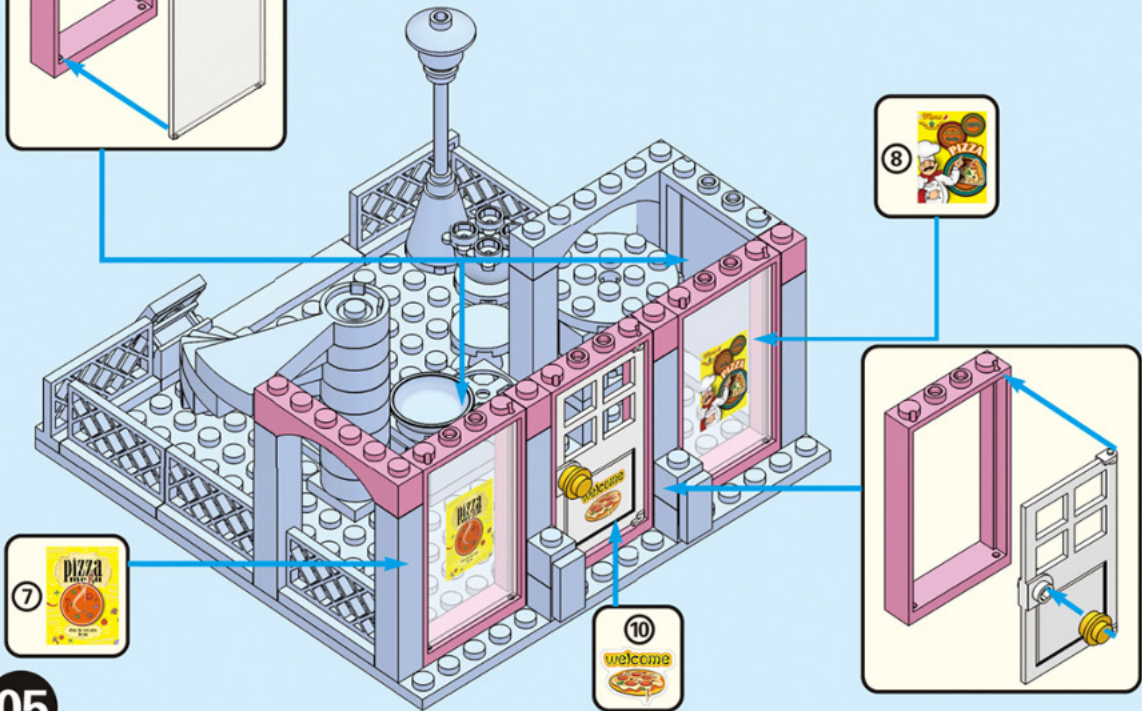
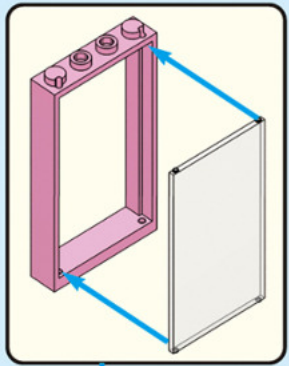

05

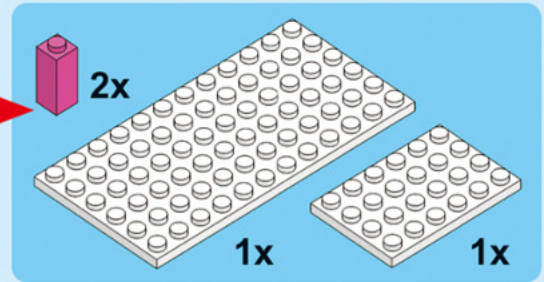

8.

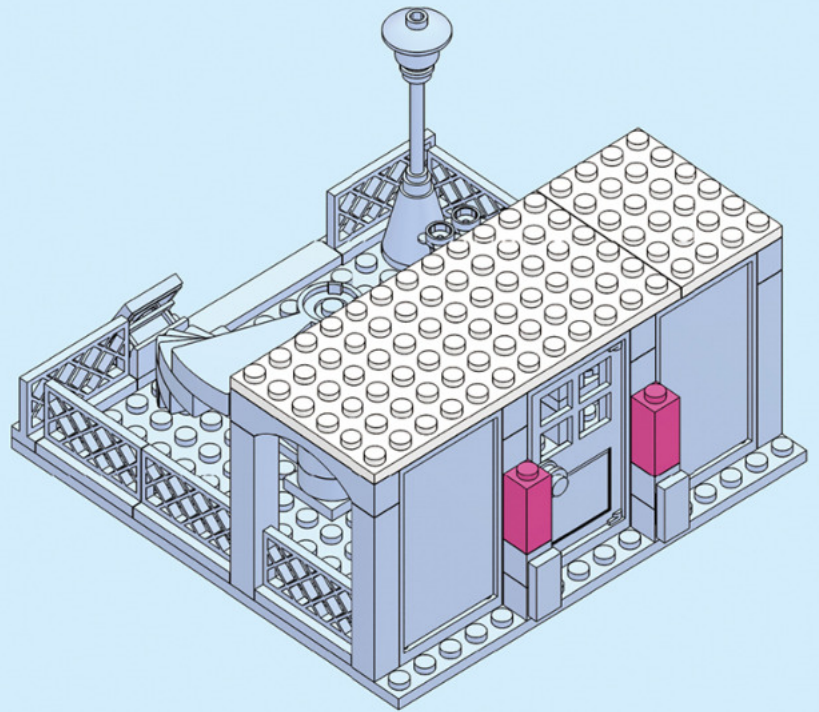

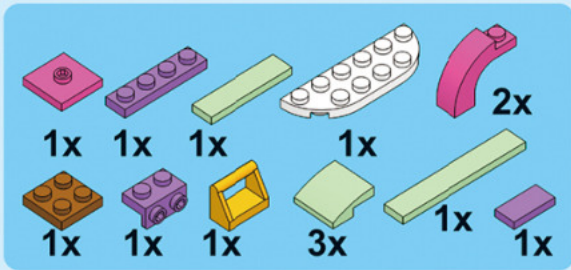

9.

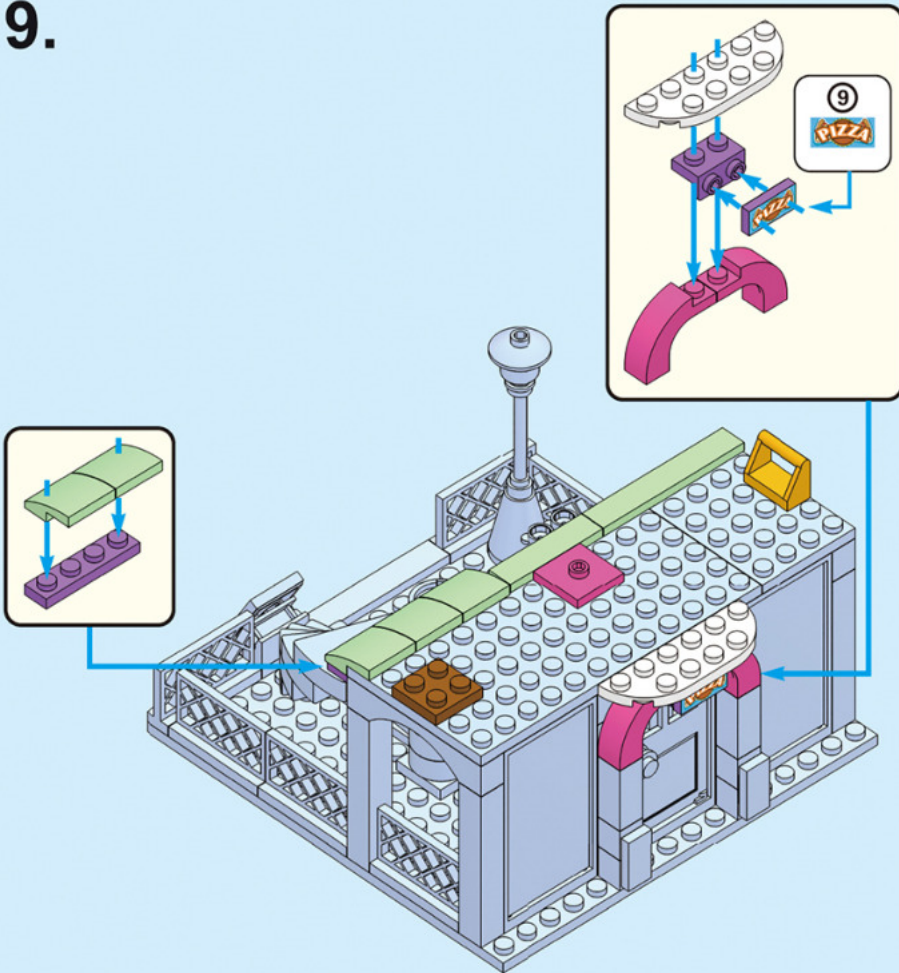

10.

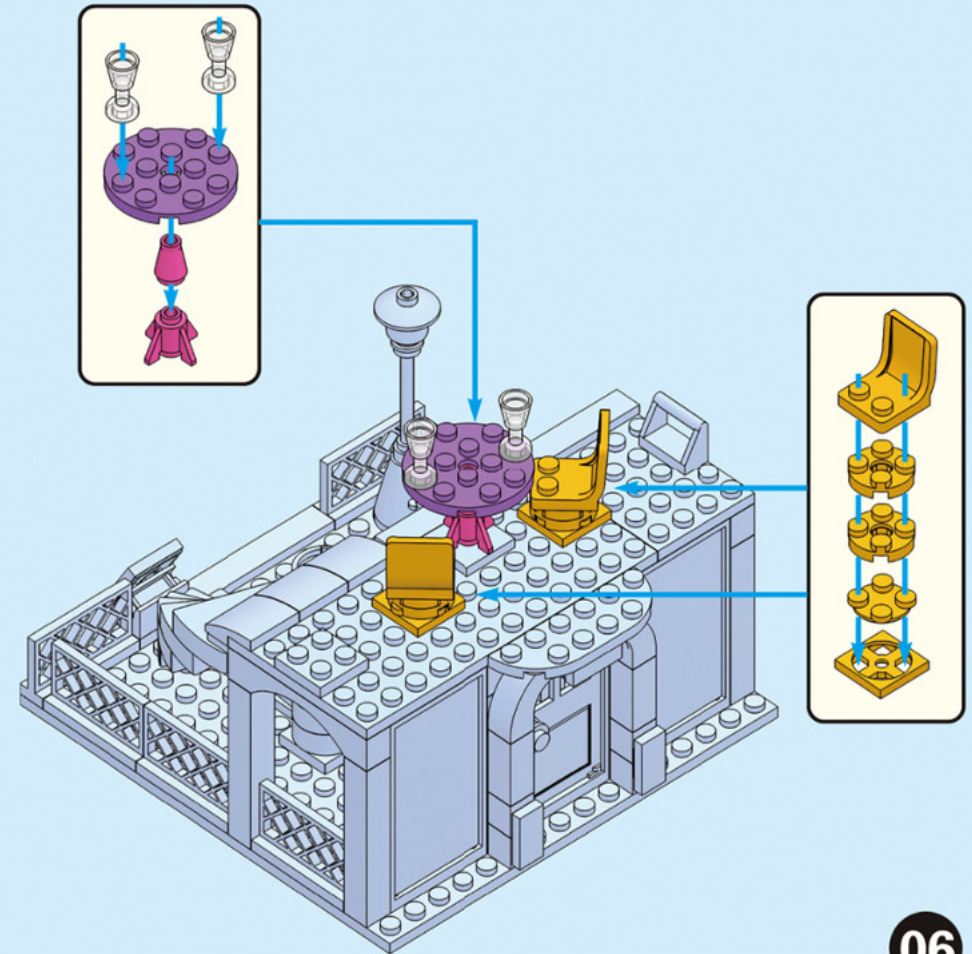

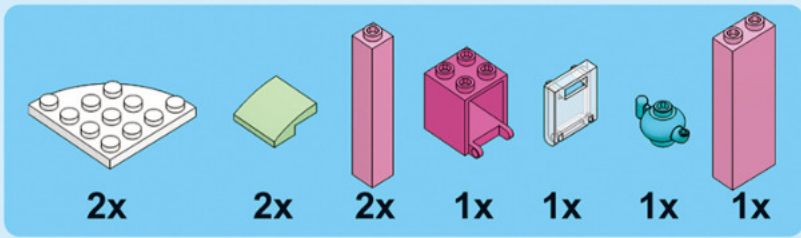

11.

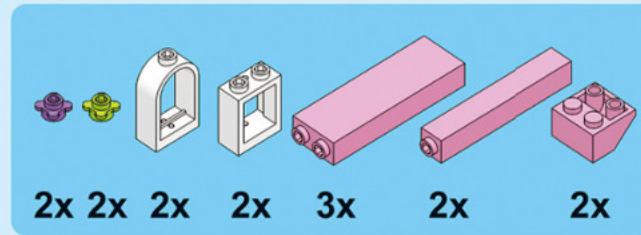
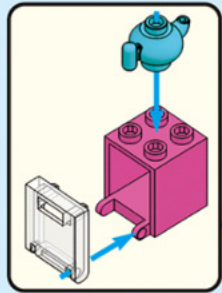
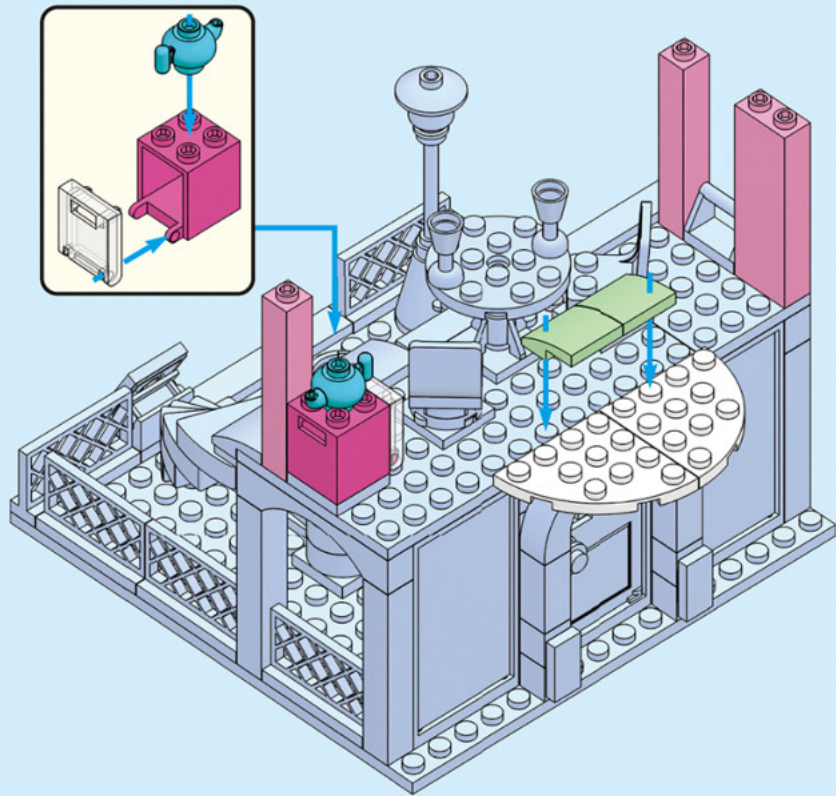

12.

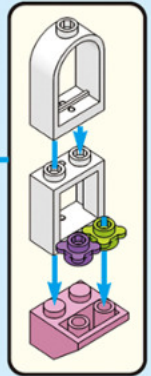
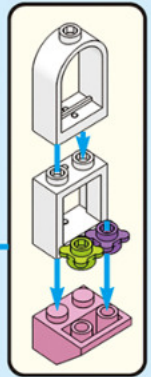
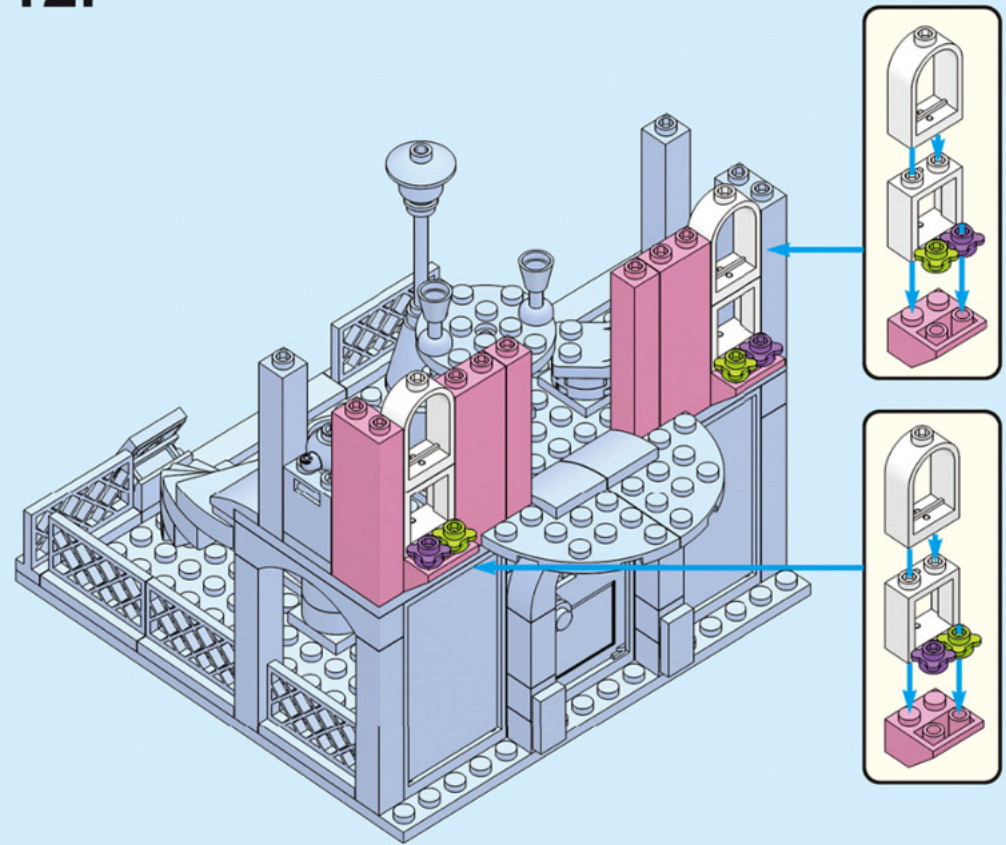

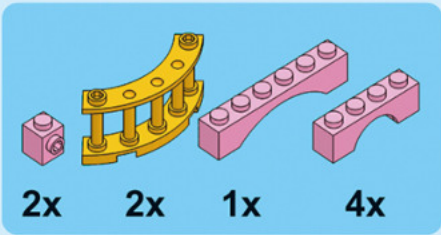

13.

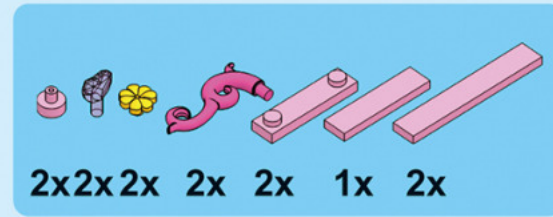
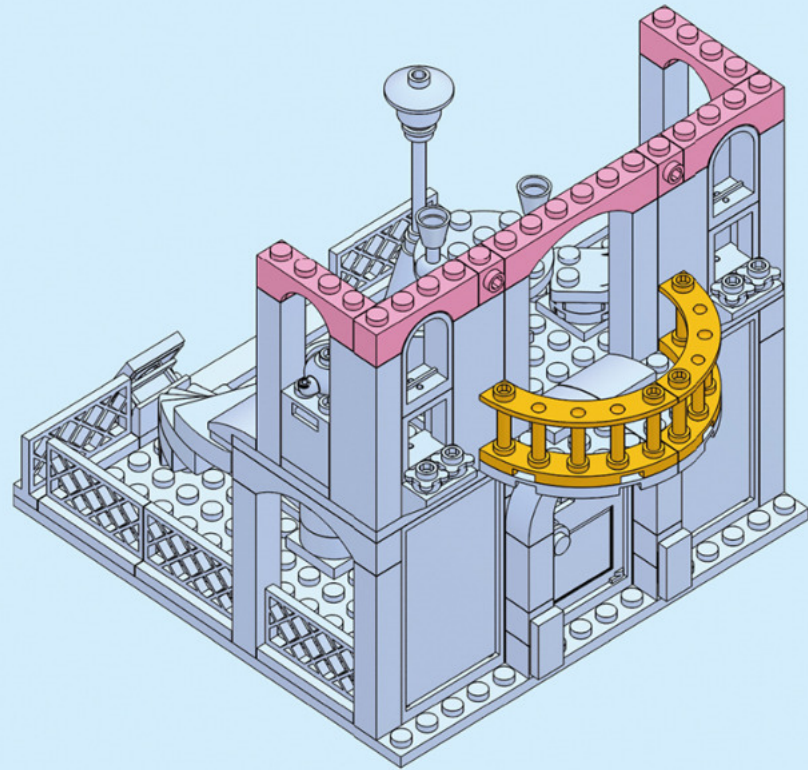

14.

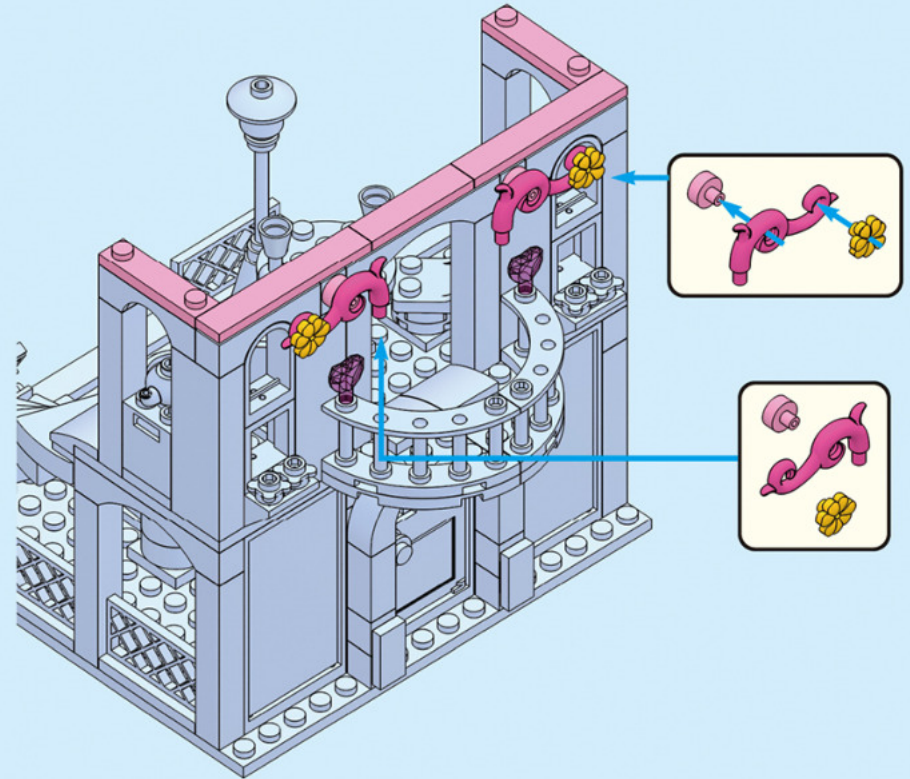

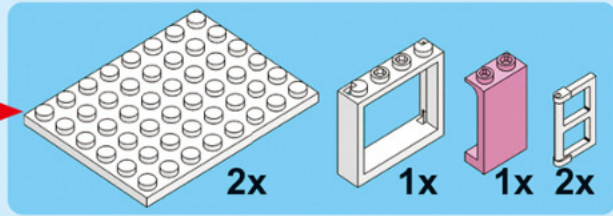

15.

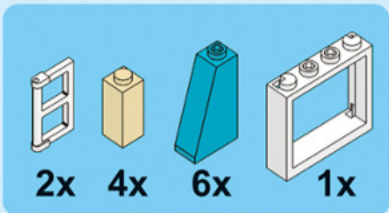
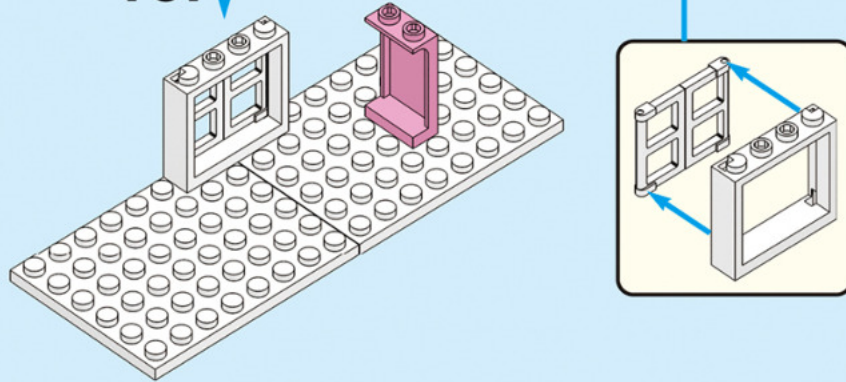

16.

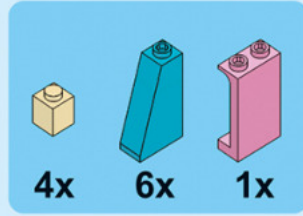
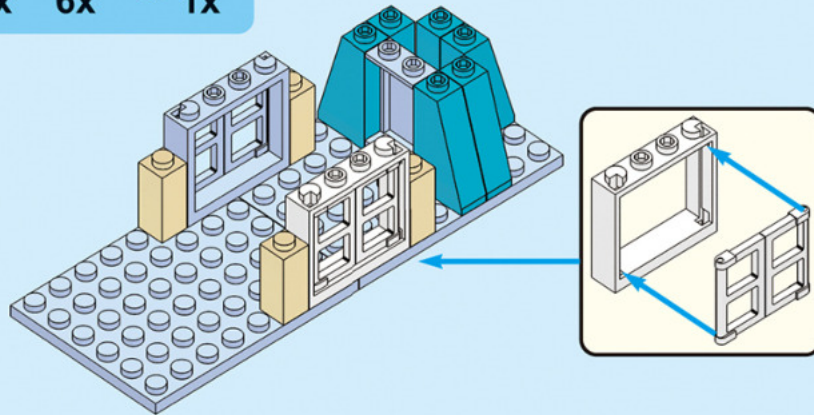

17.

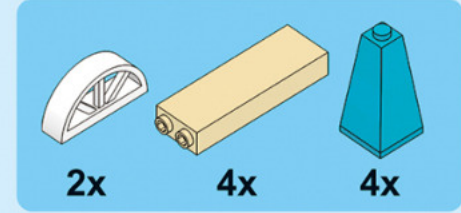
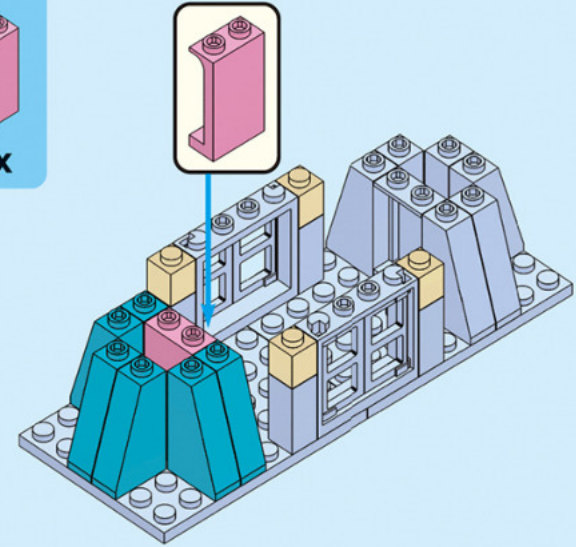

18.

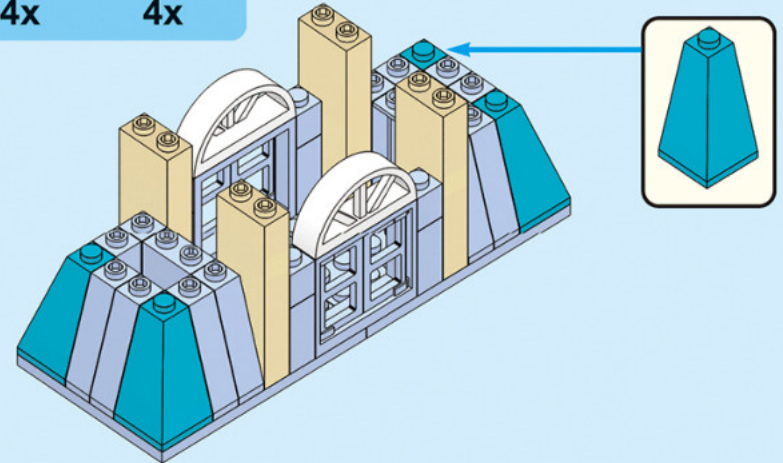

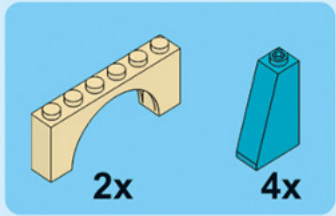

19.

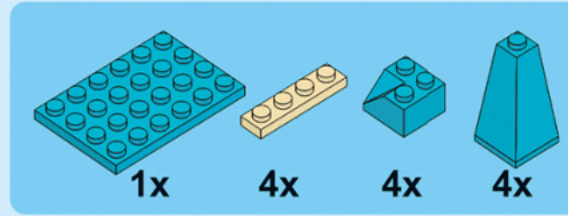
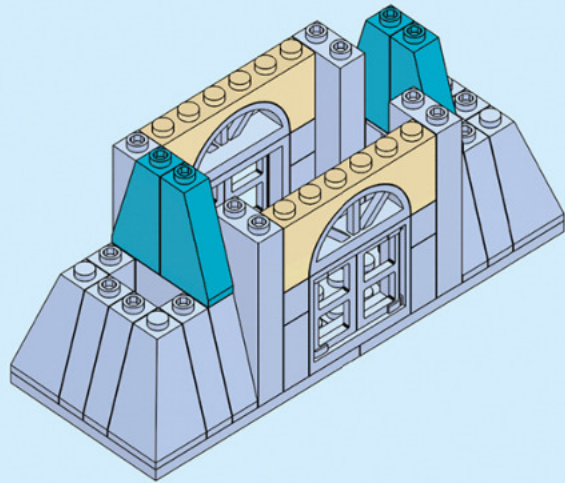

20.

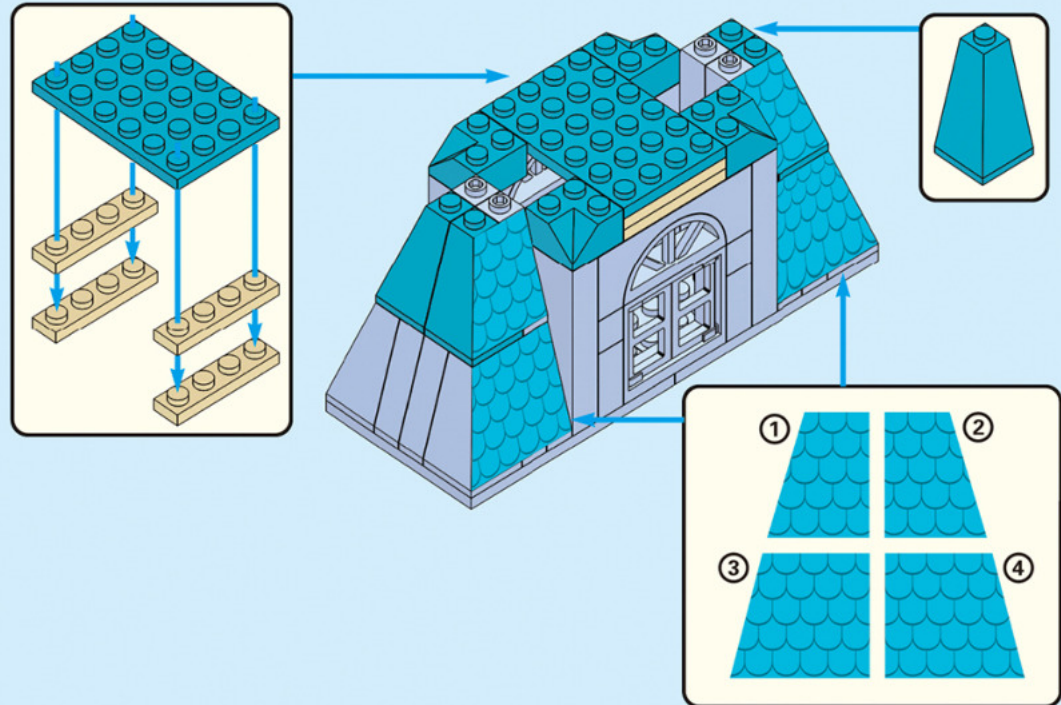

24.

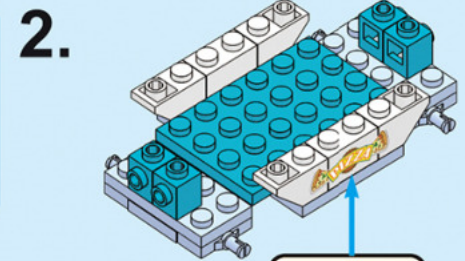
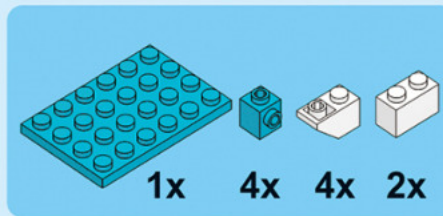
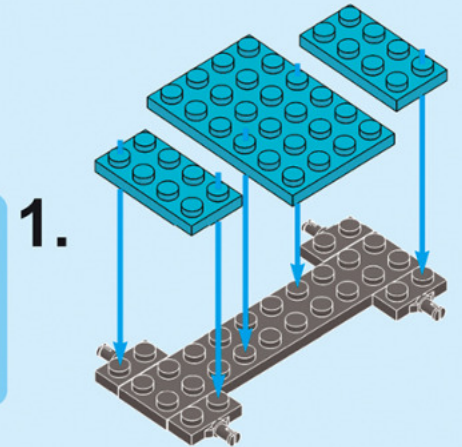
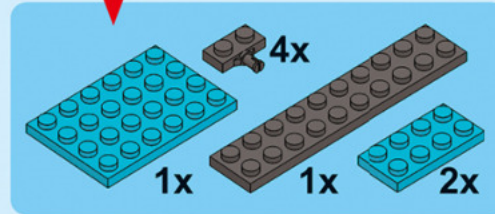
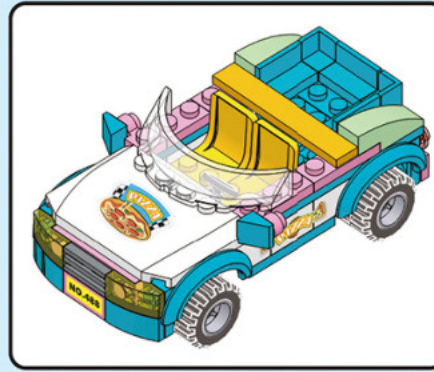
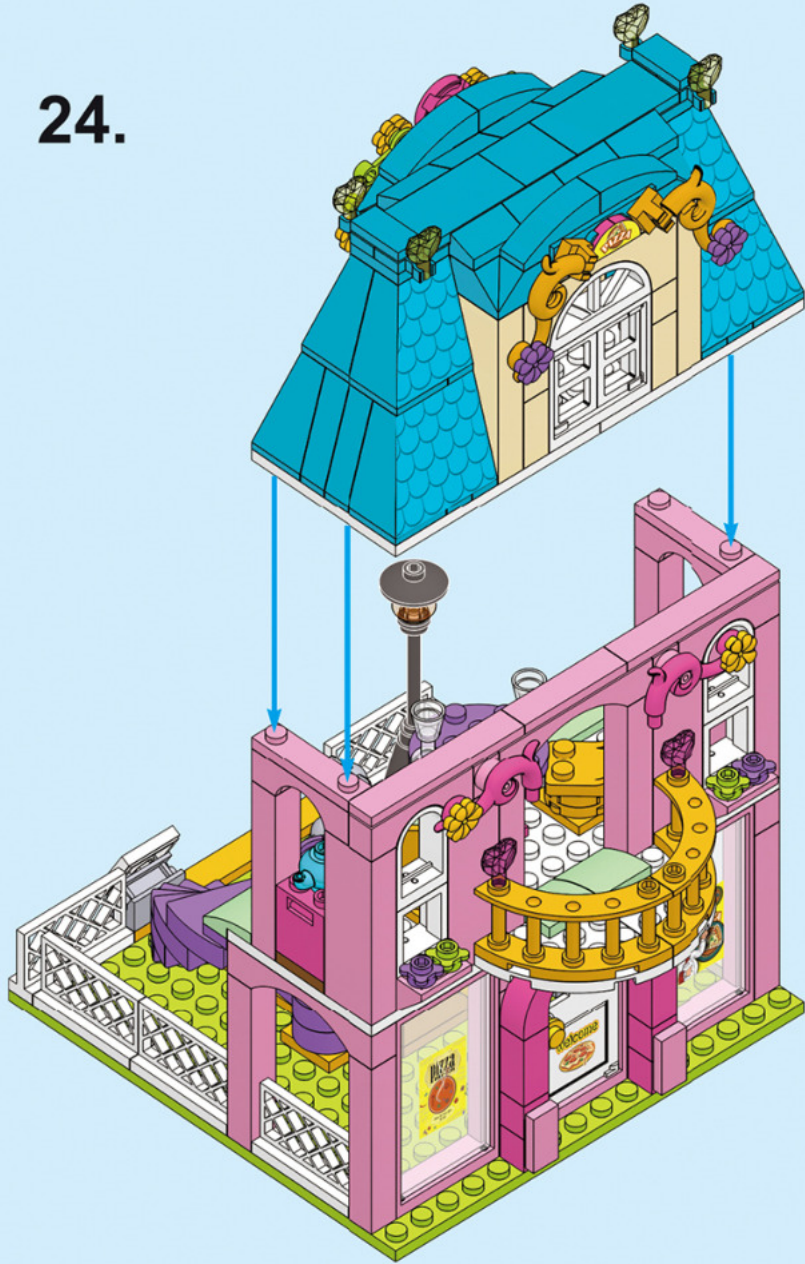

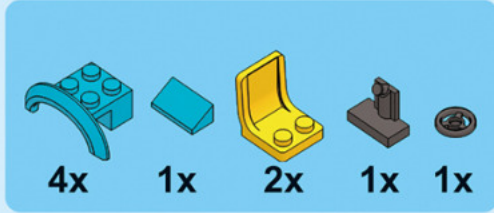

3.

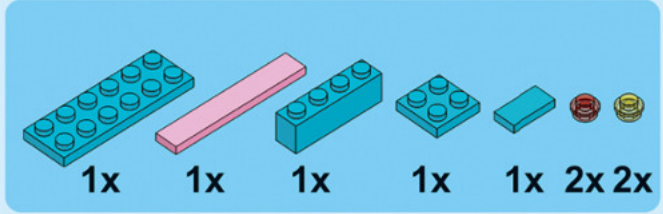
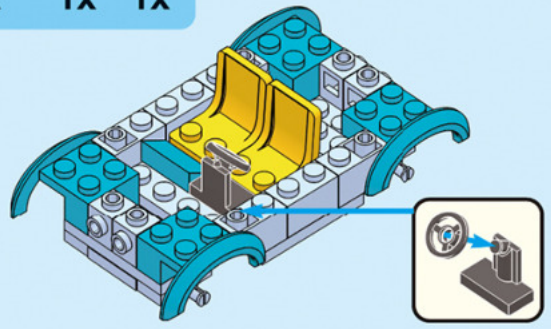

4.

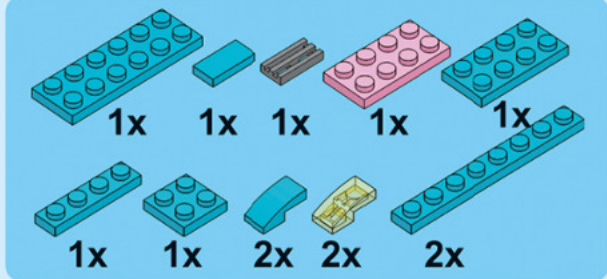
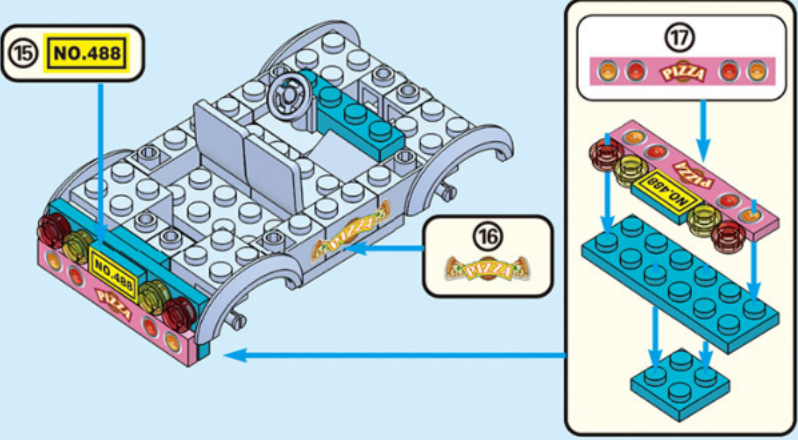

5.

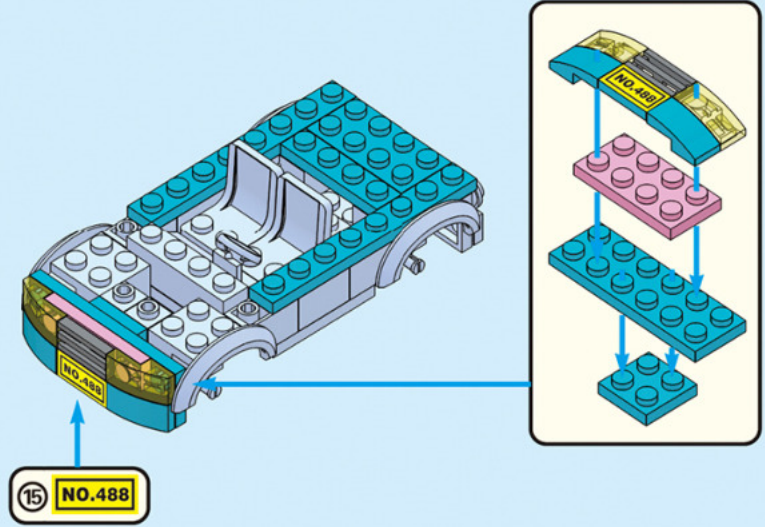



2x 2x 2x 2x

6.

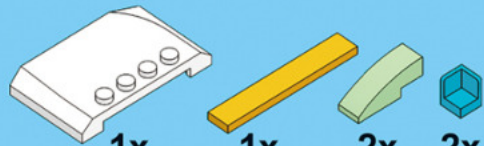
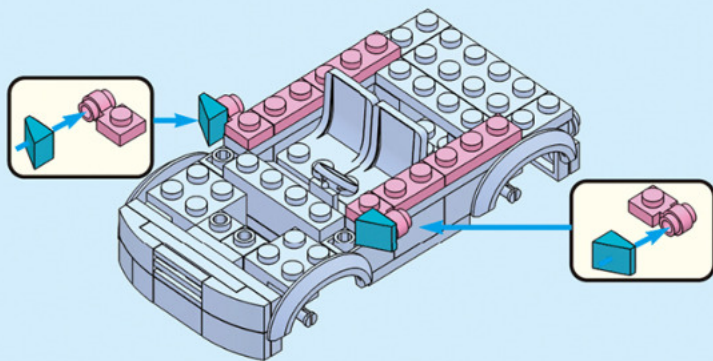

1x 1x 2x 2x

7.

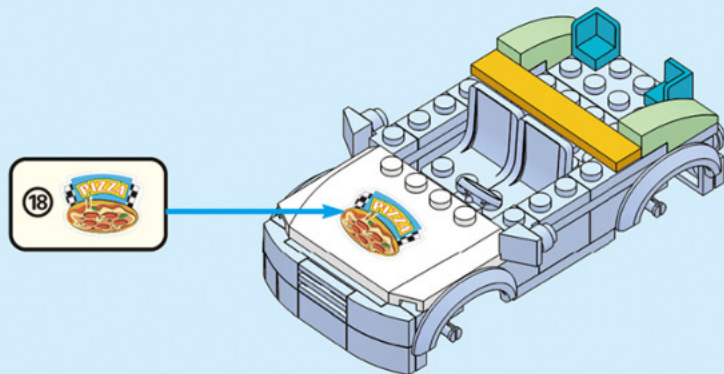

3x 1x

8.

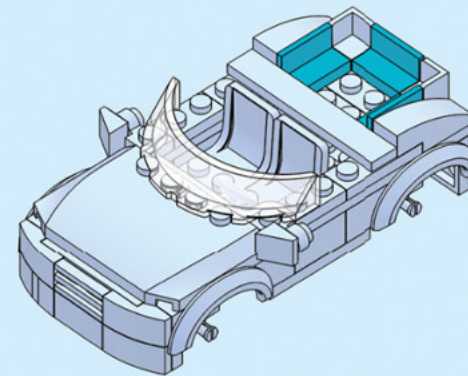

4x 4x

9.

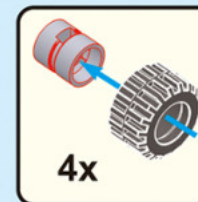
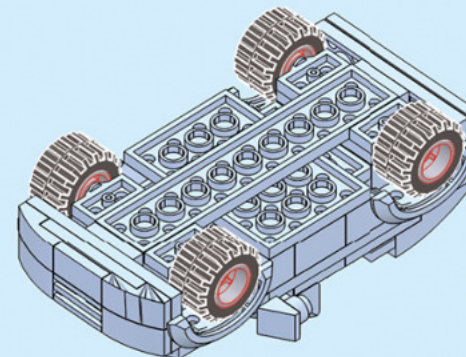

4x