

1.

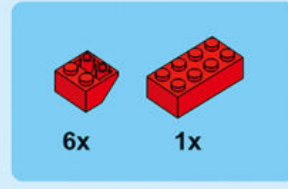

2.

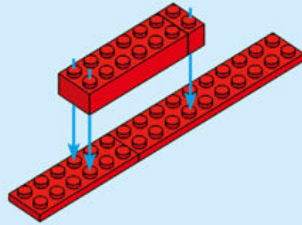
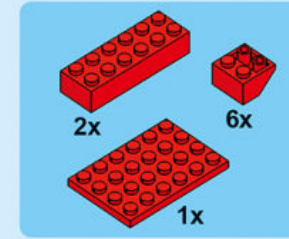
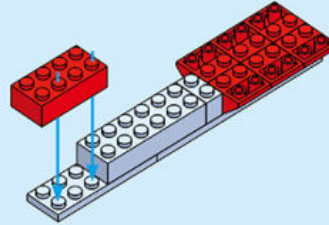

3.

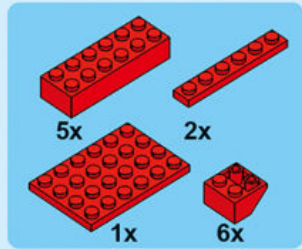
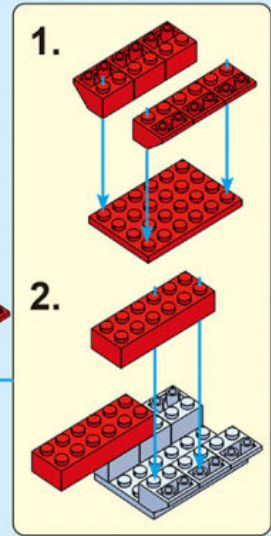
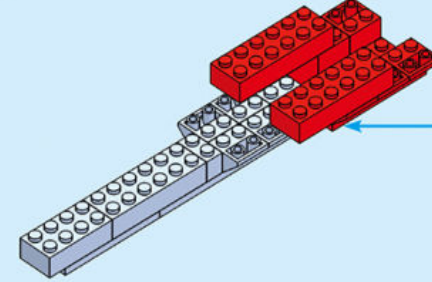

4.

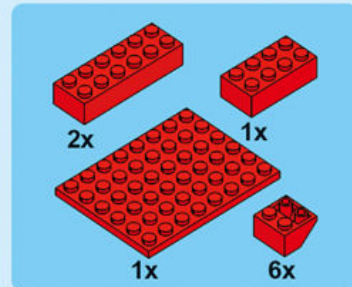
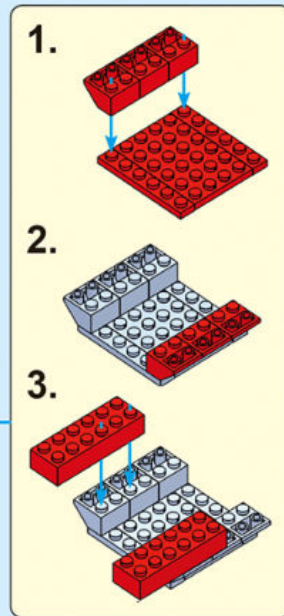
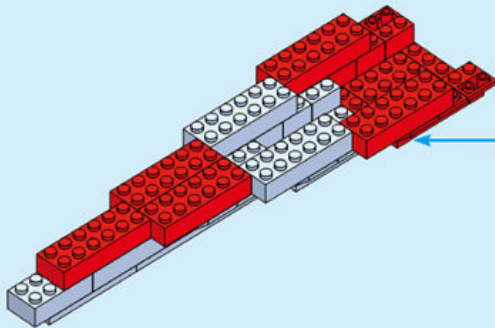

5.

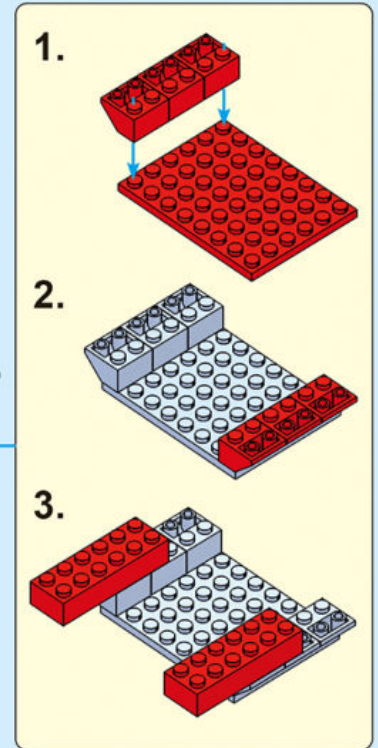
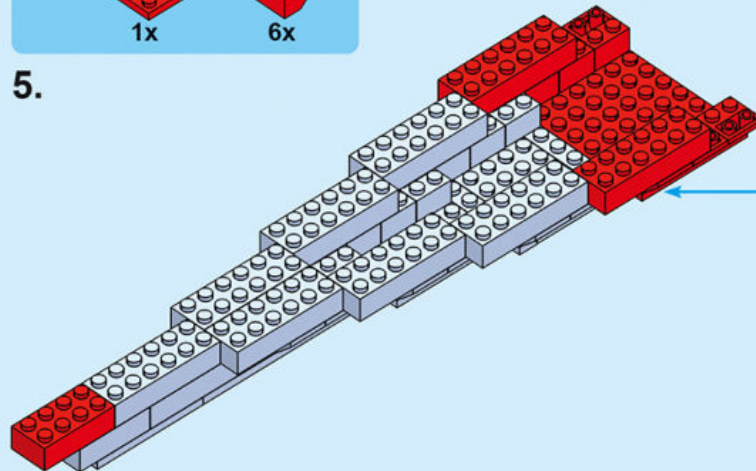

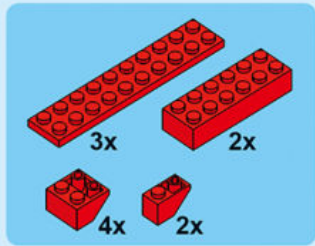

6.

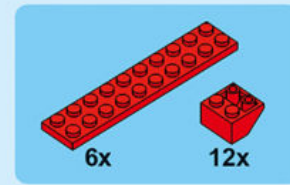
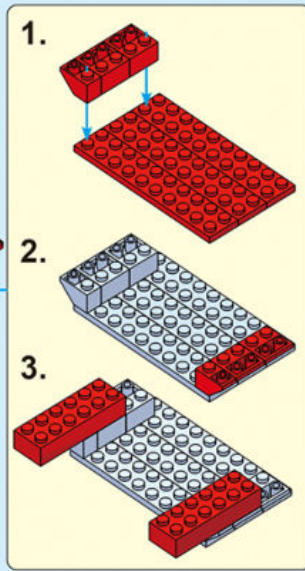
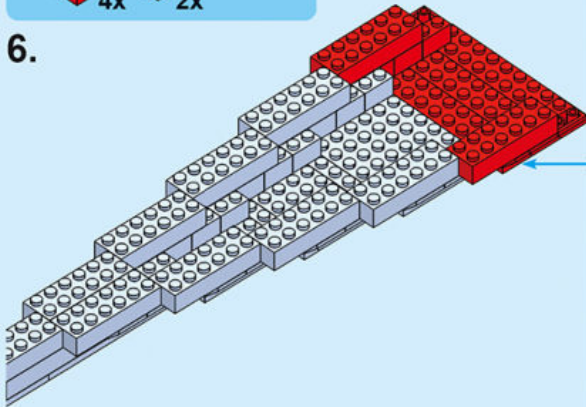

7.

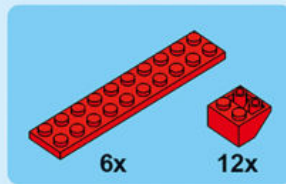
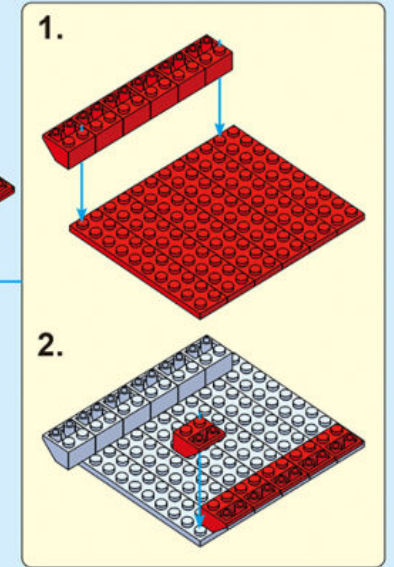
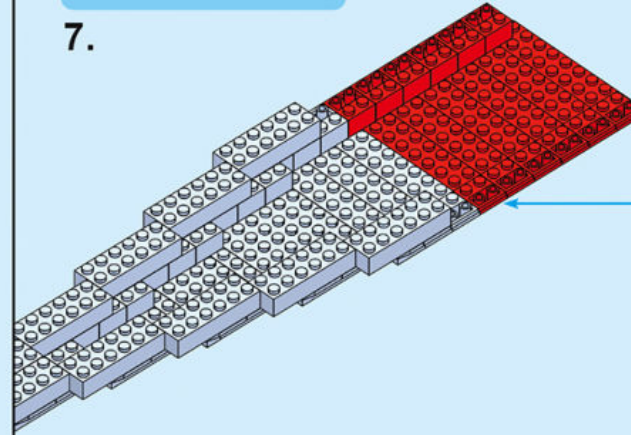

8.

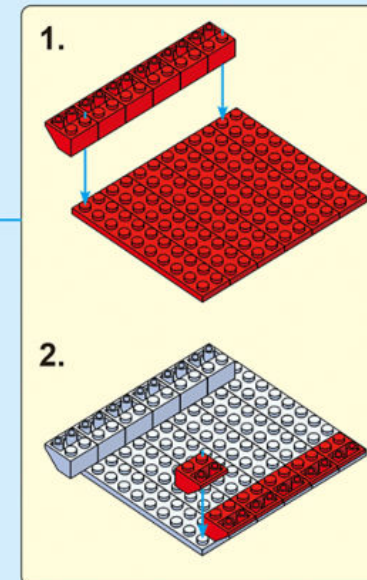
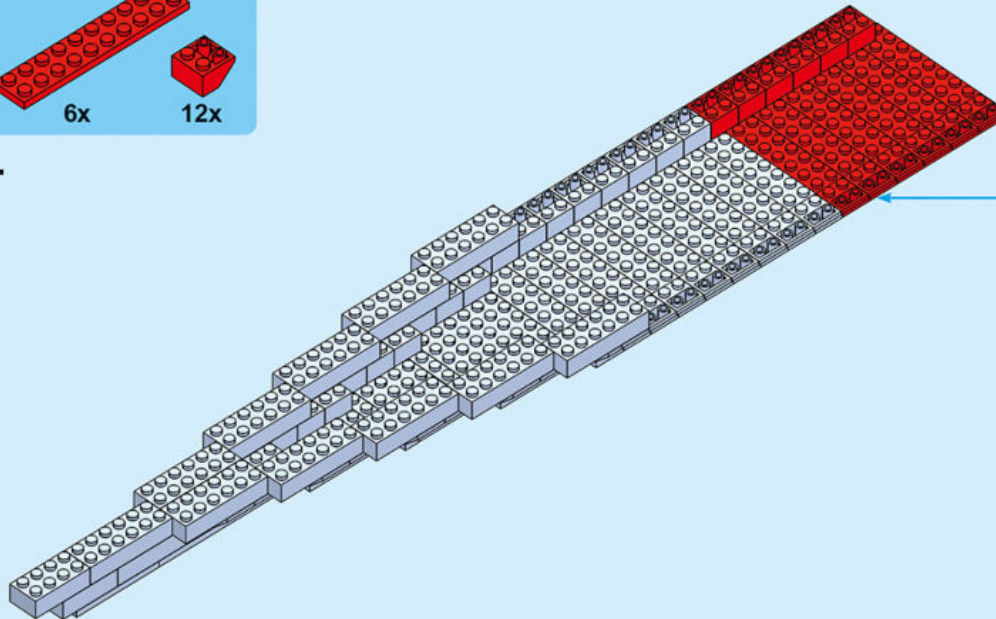

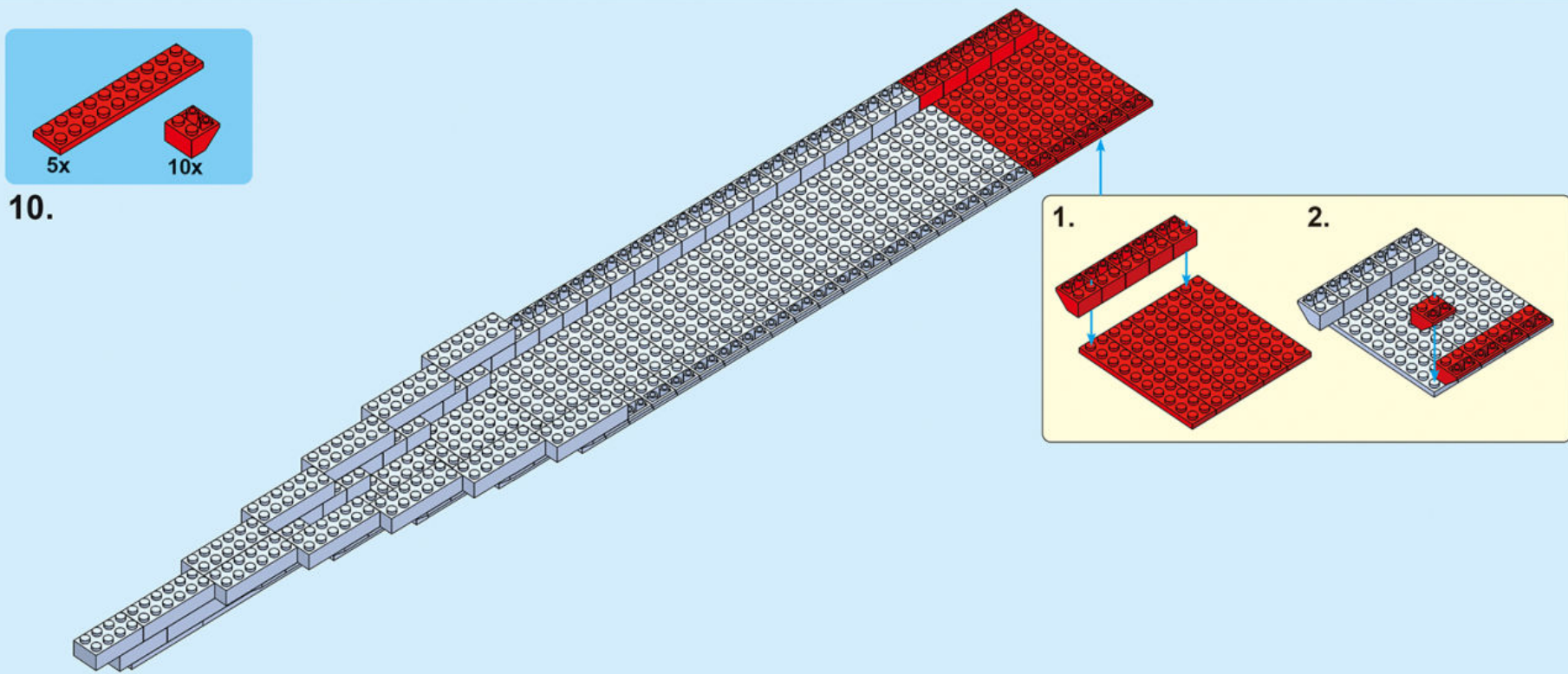
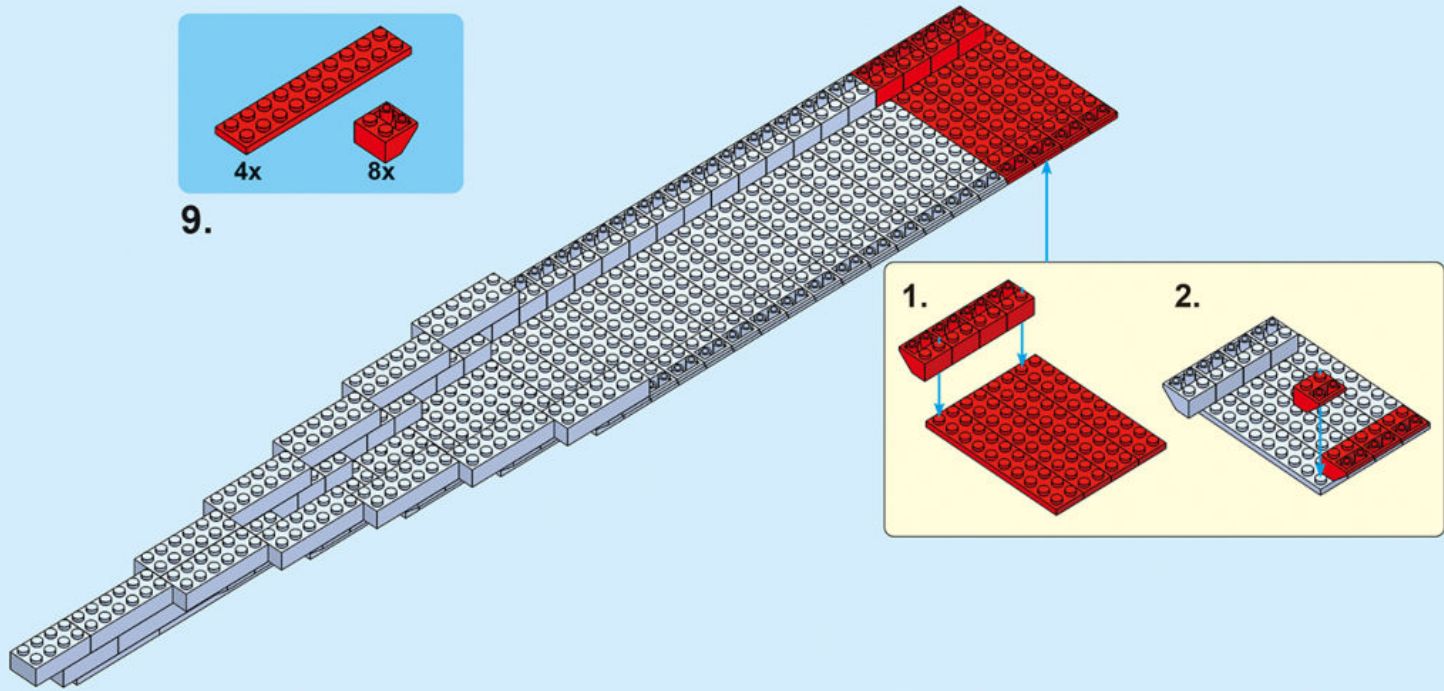

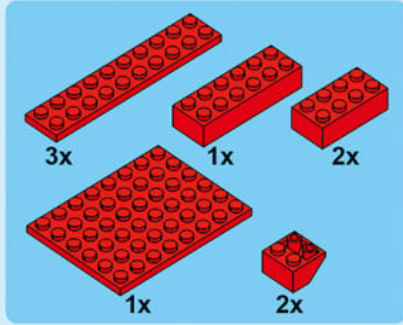

11.

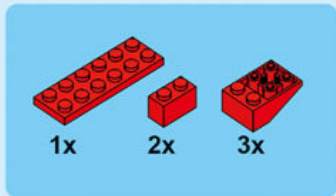
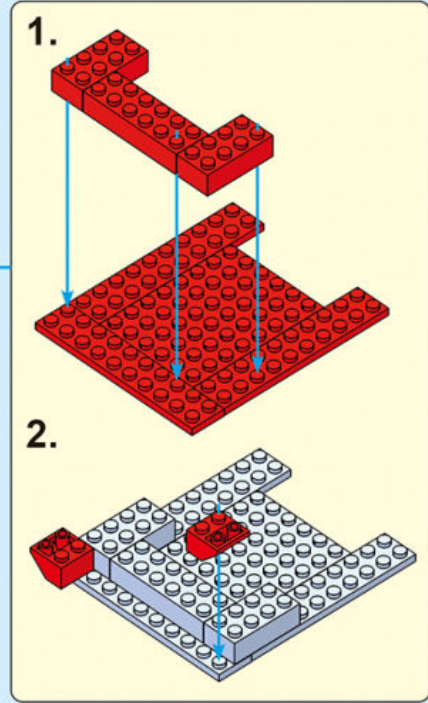
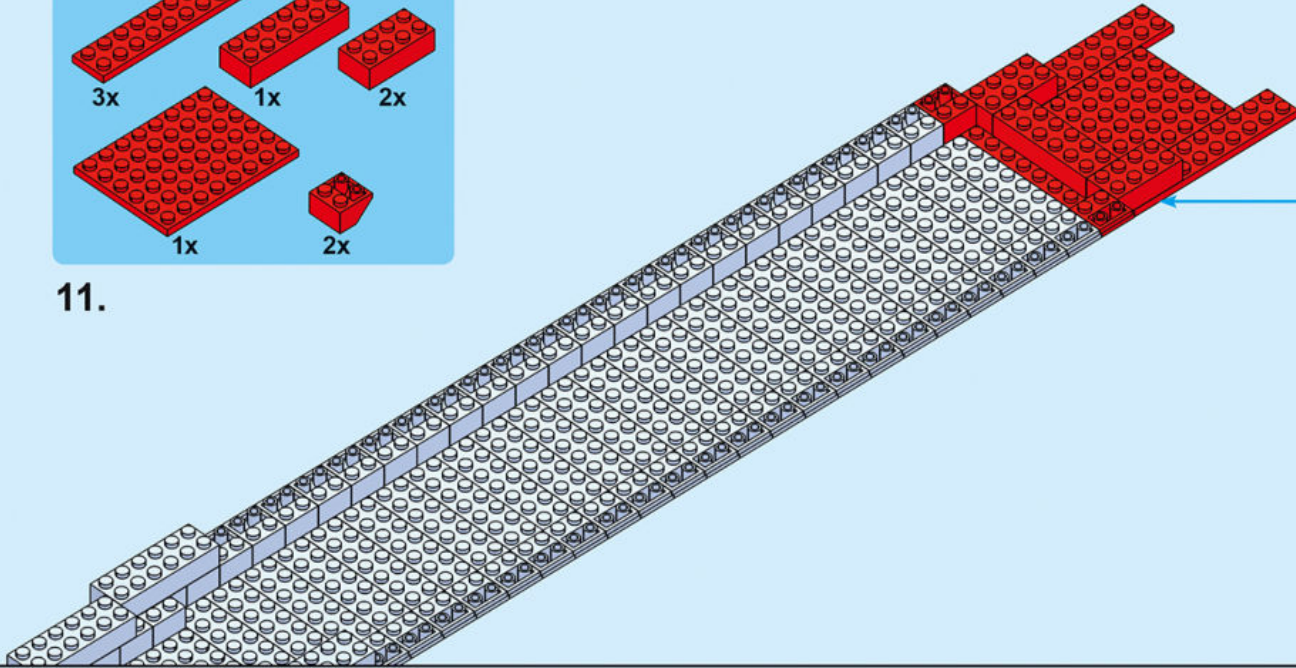

12.

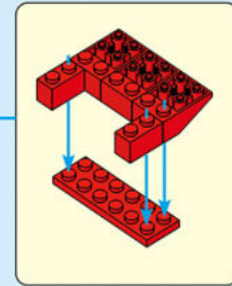
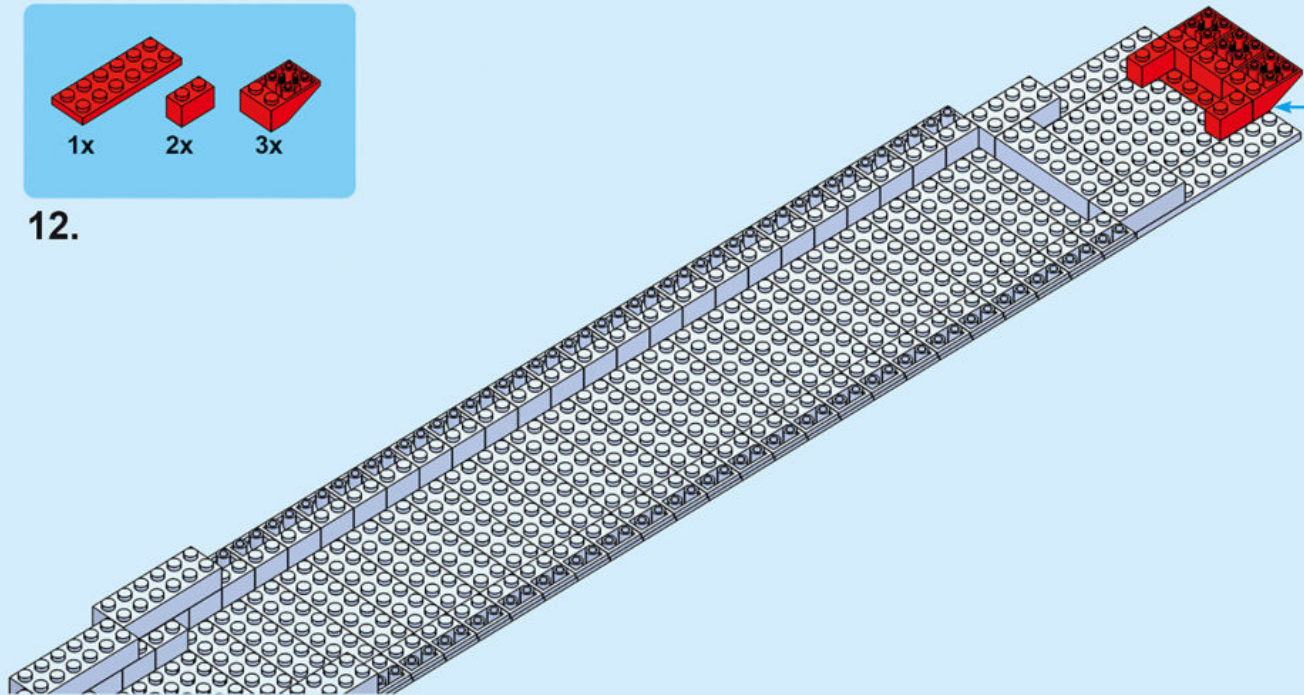

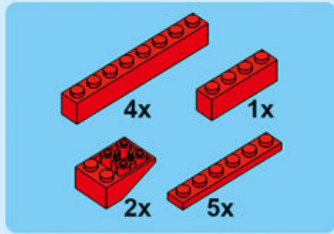

13.

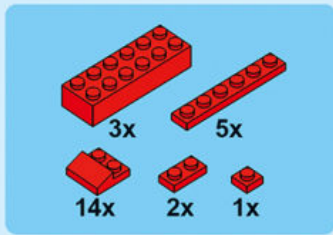
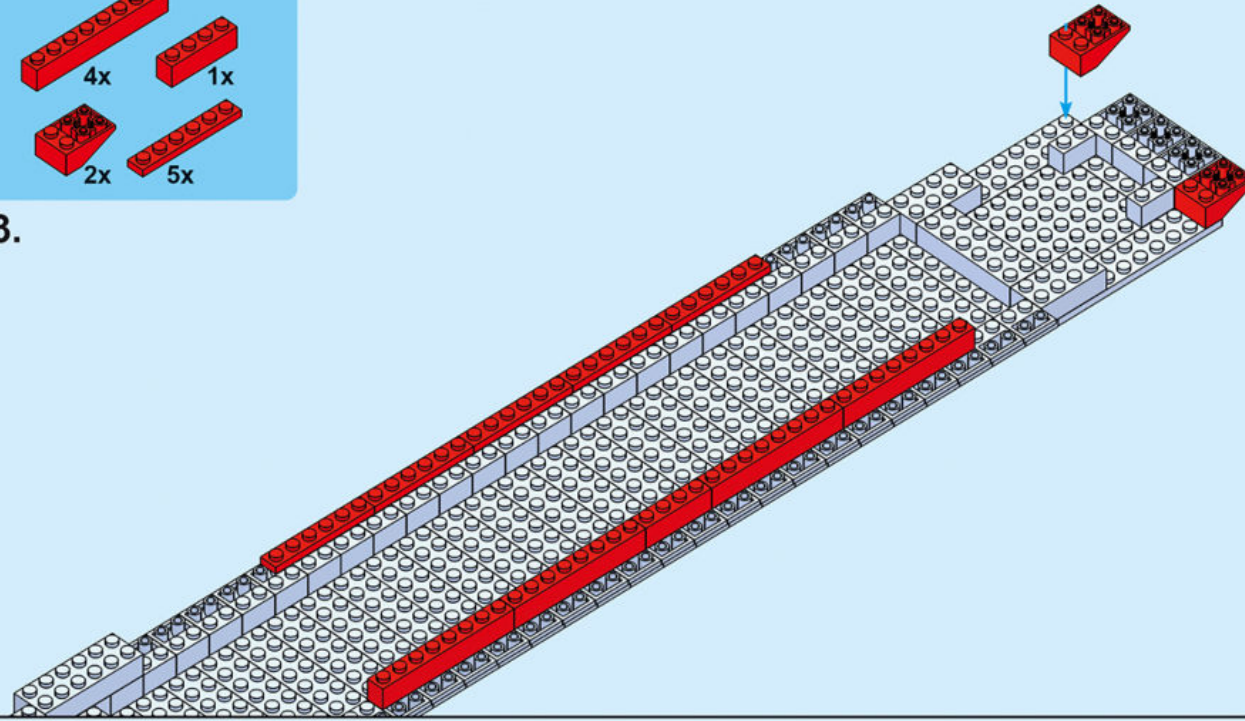

14.

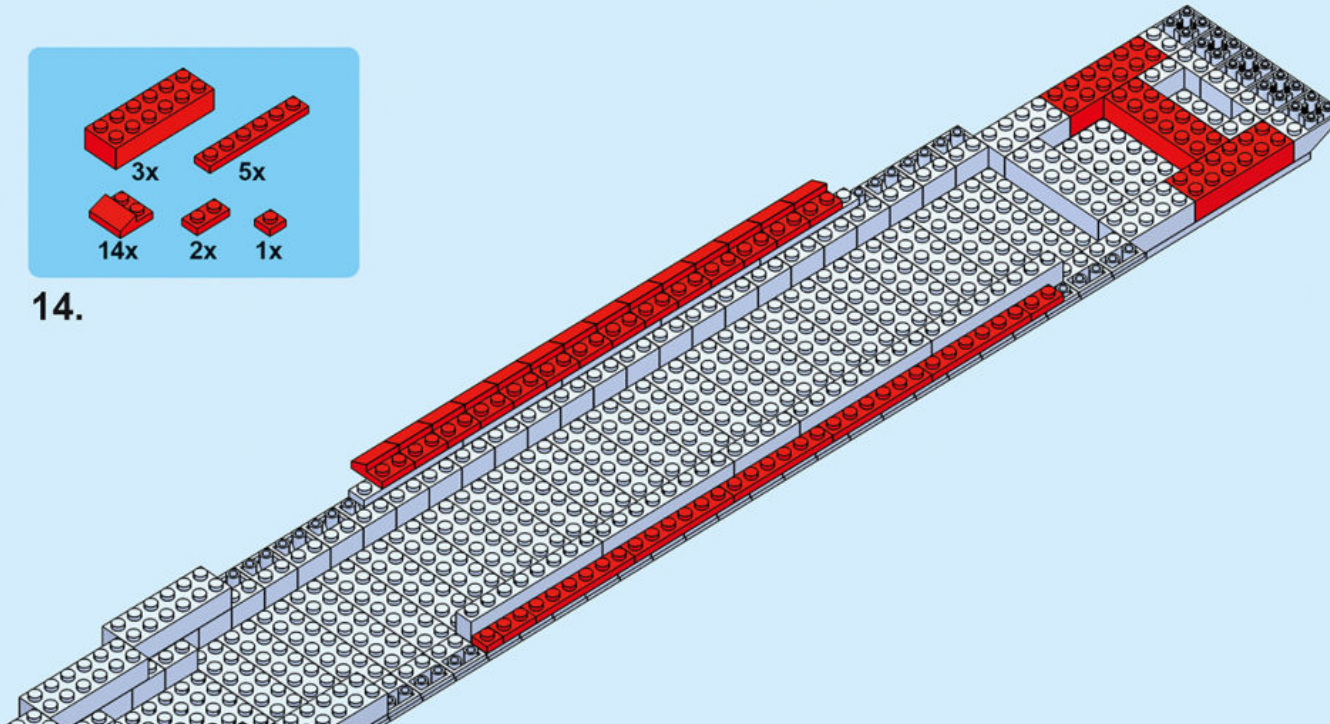

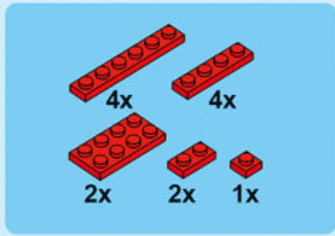

15.

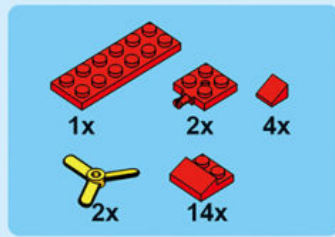
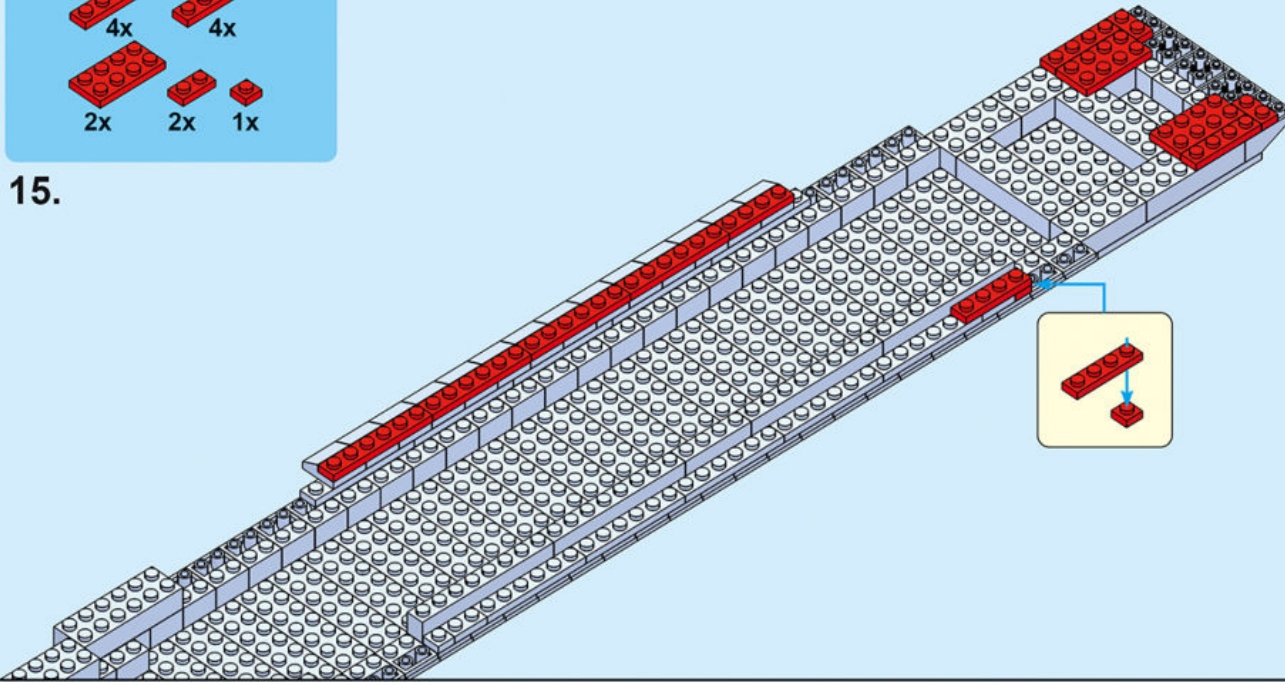

16.

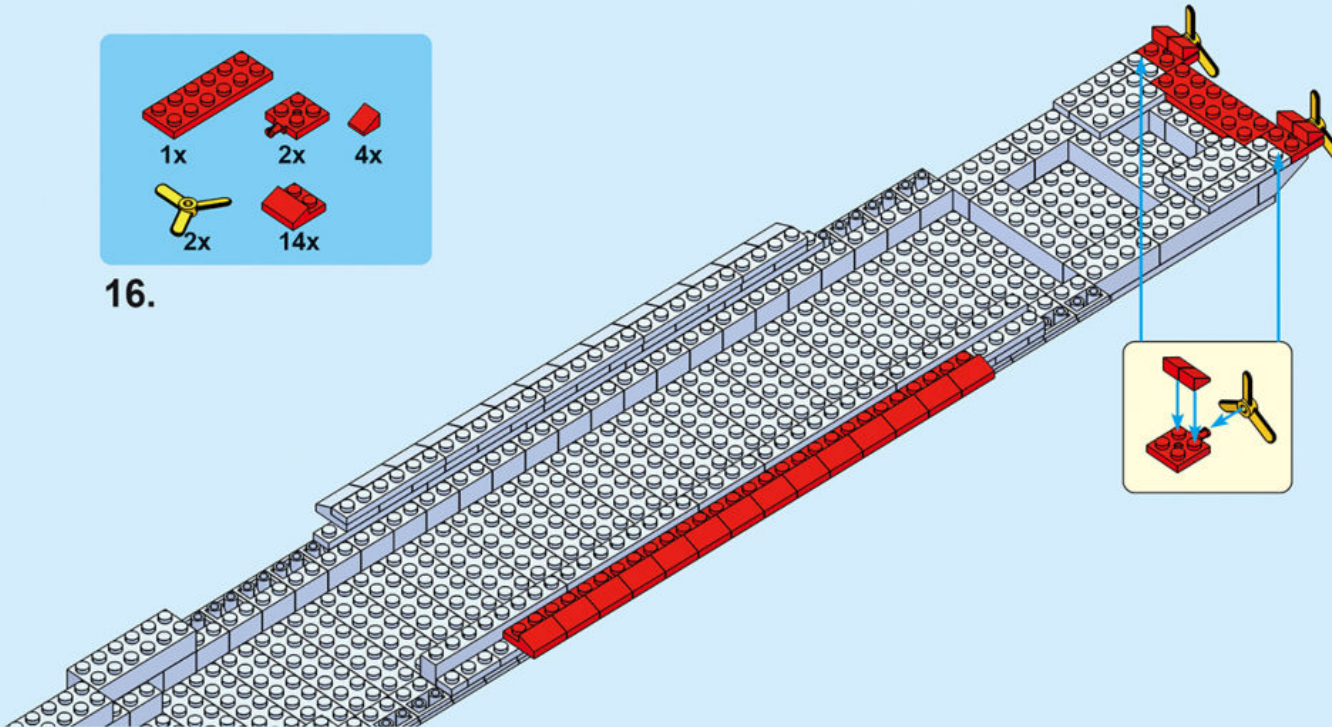

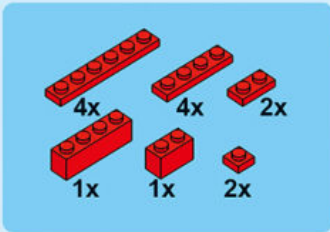

17.

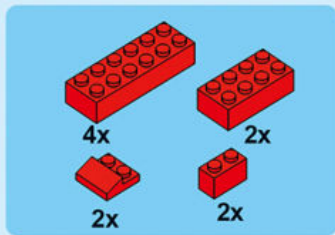
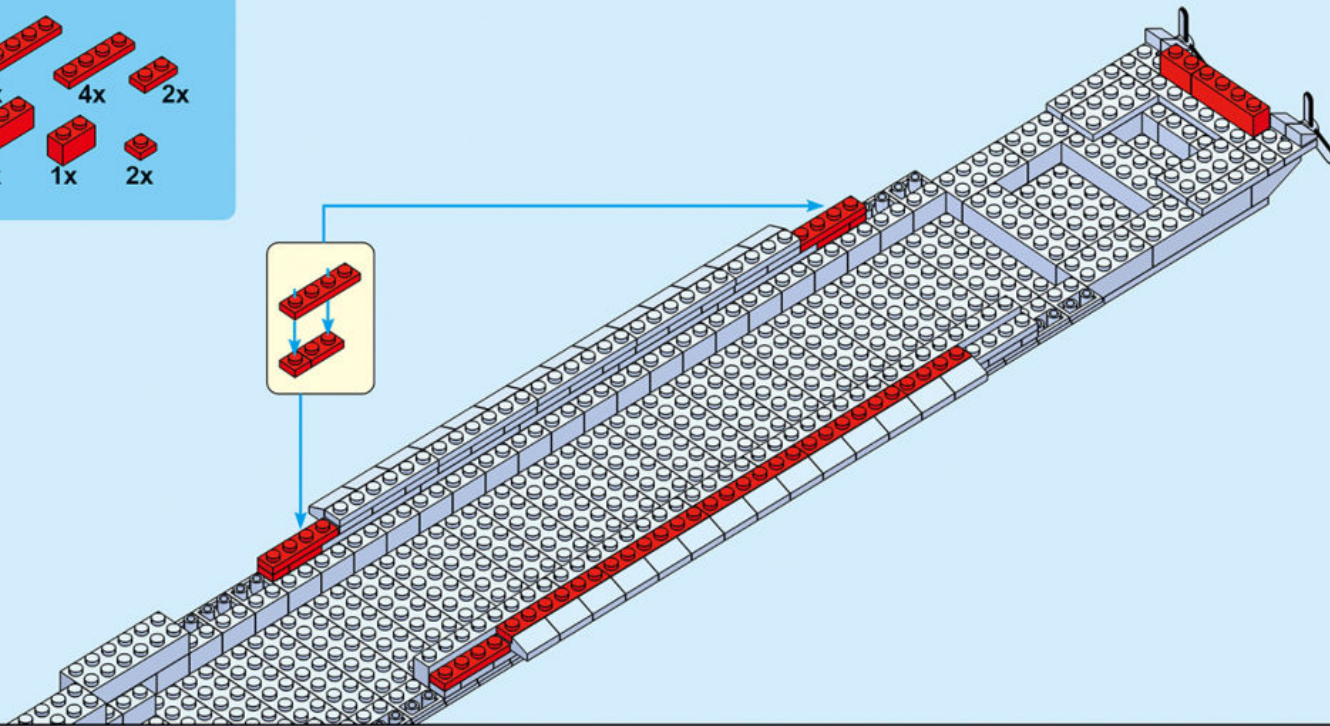
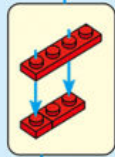

18.

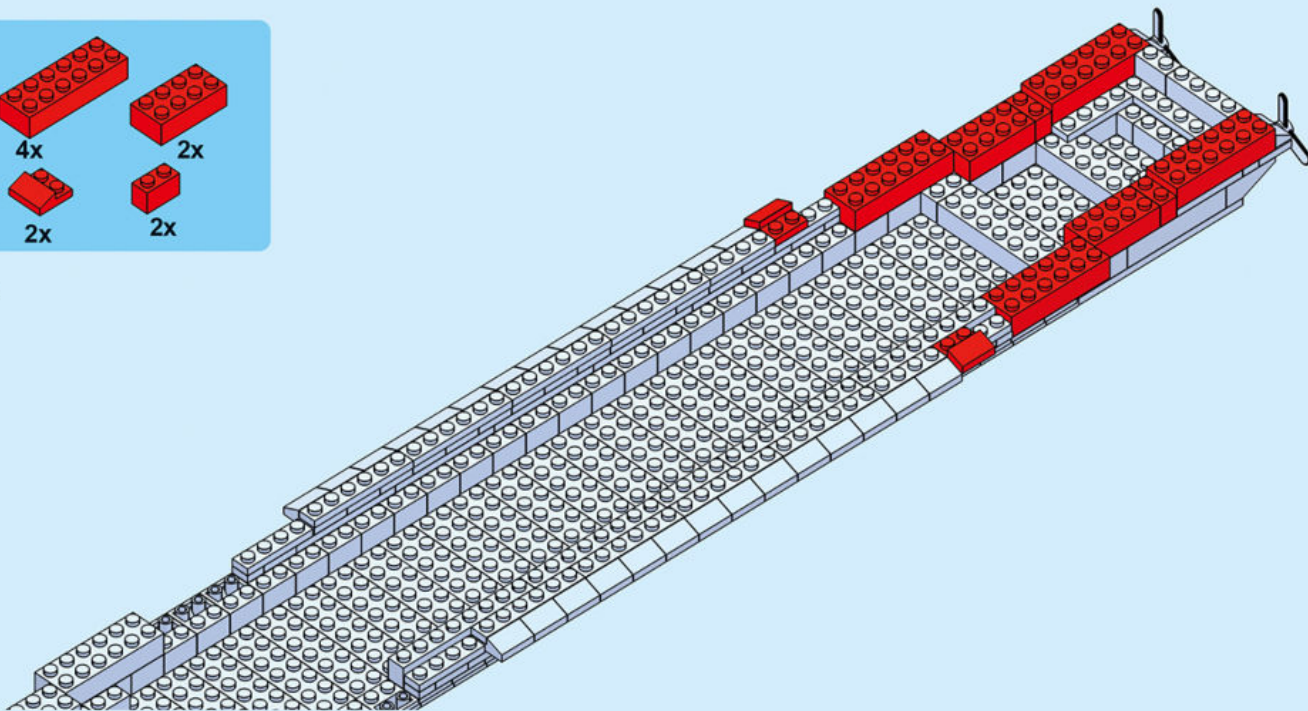

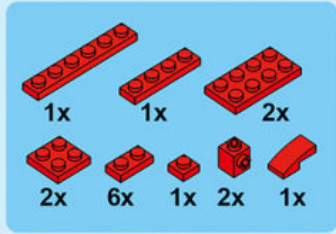

19.

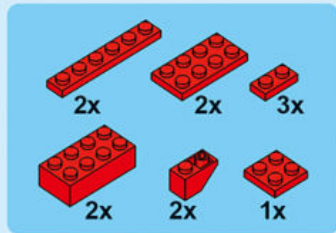
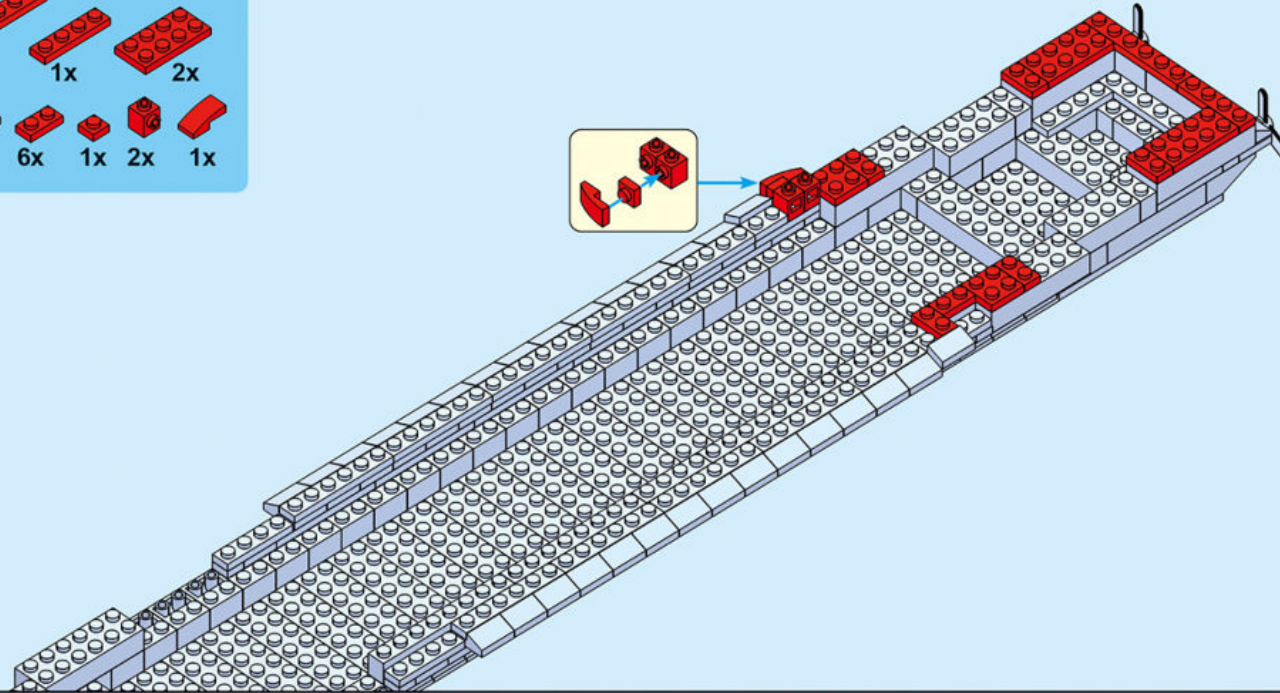

20.

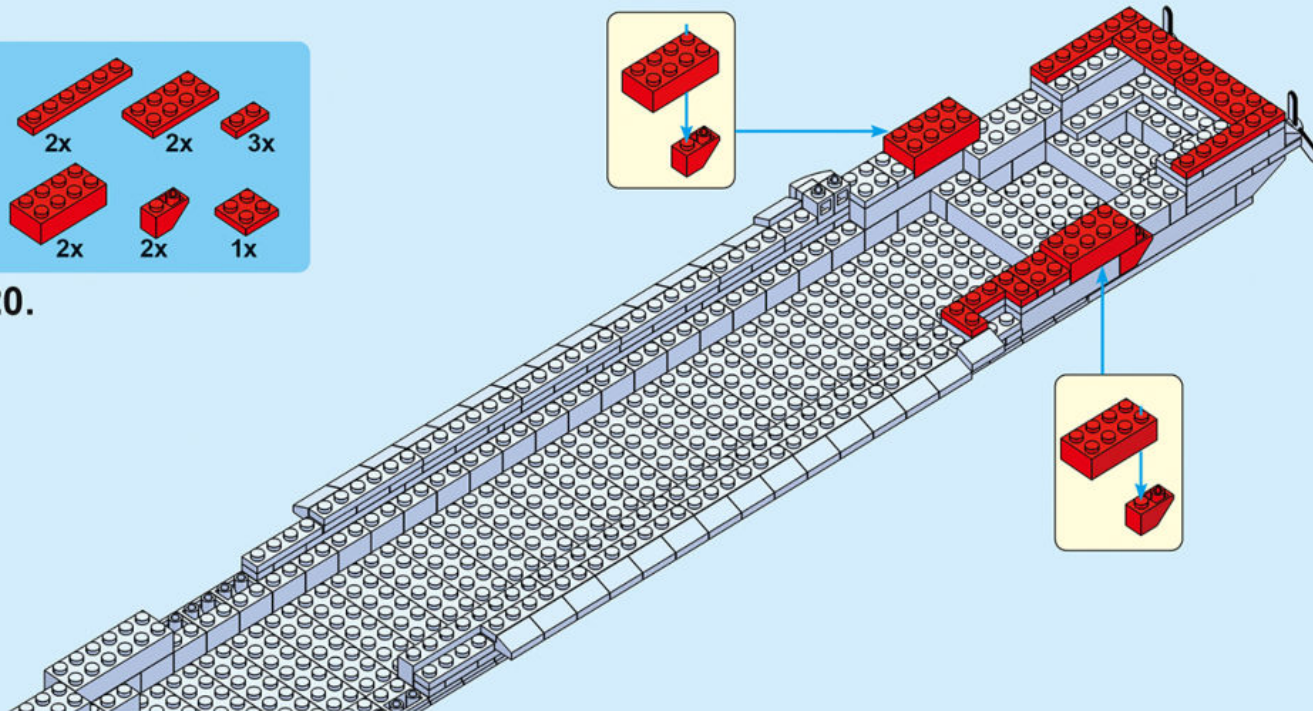



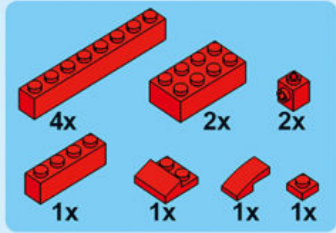

21.

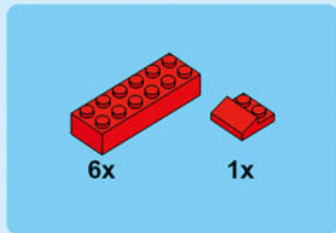
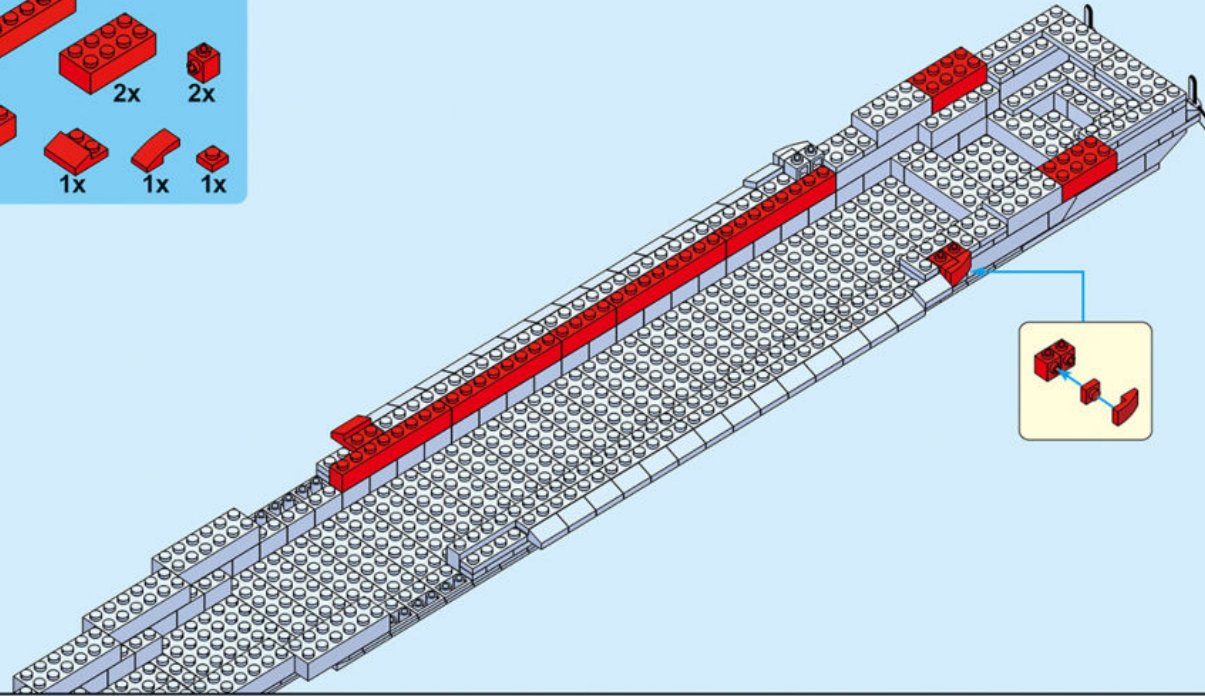

22.

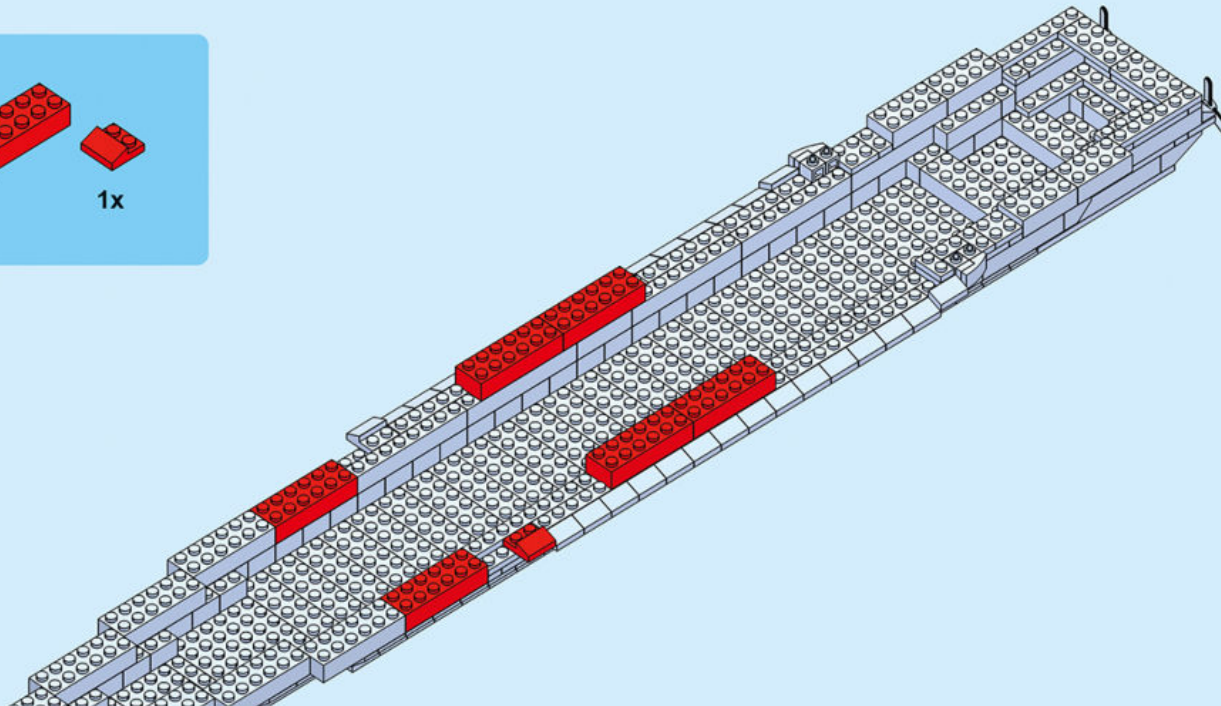

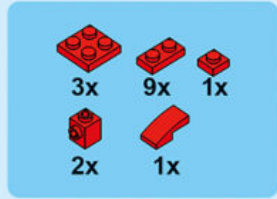

23.

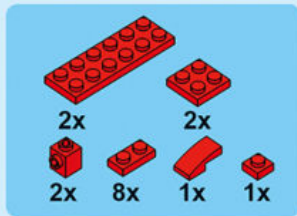
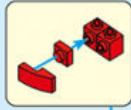
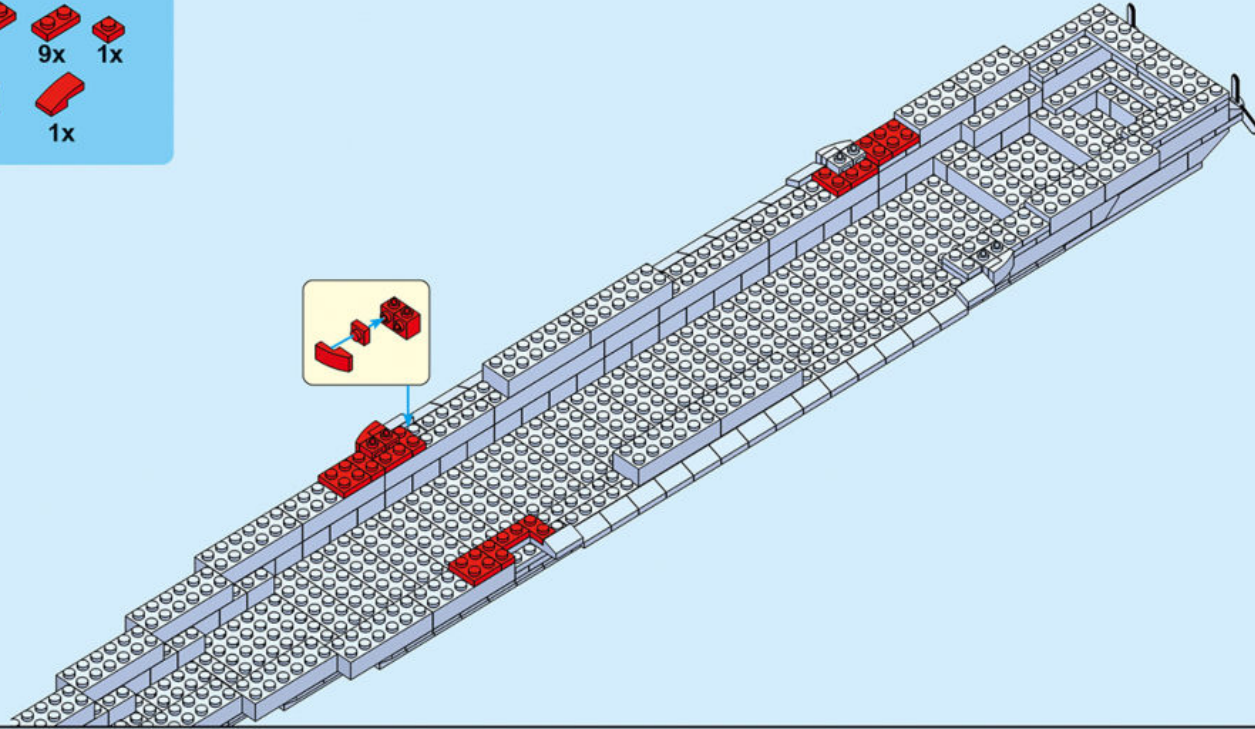

24.

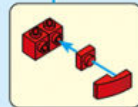
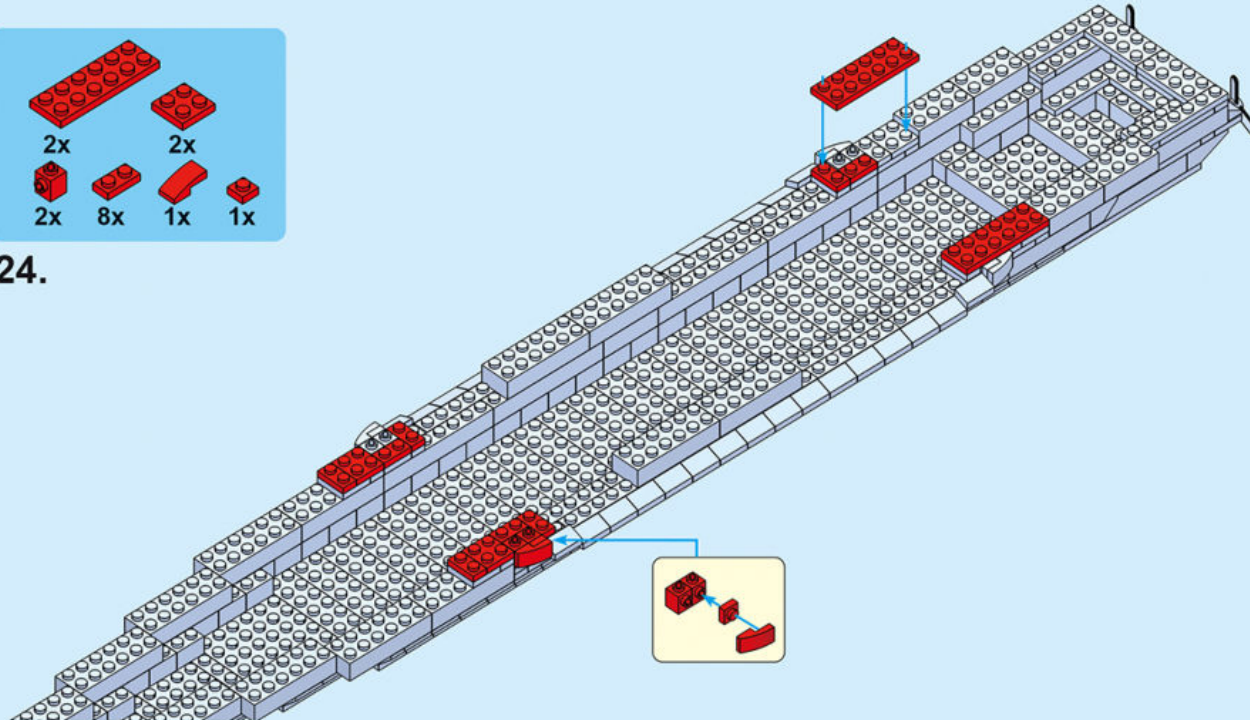

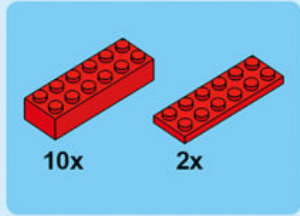

25.

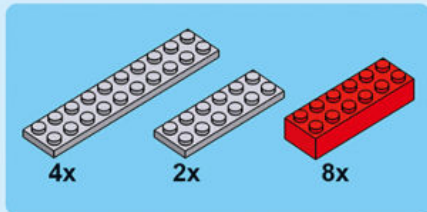
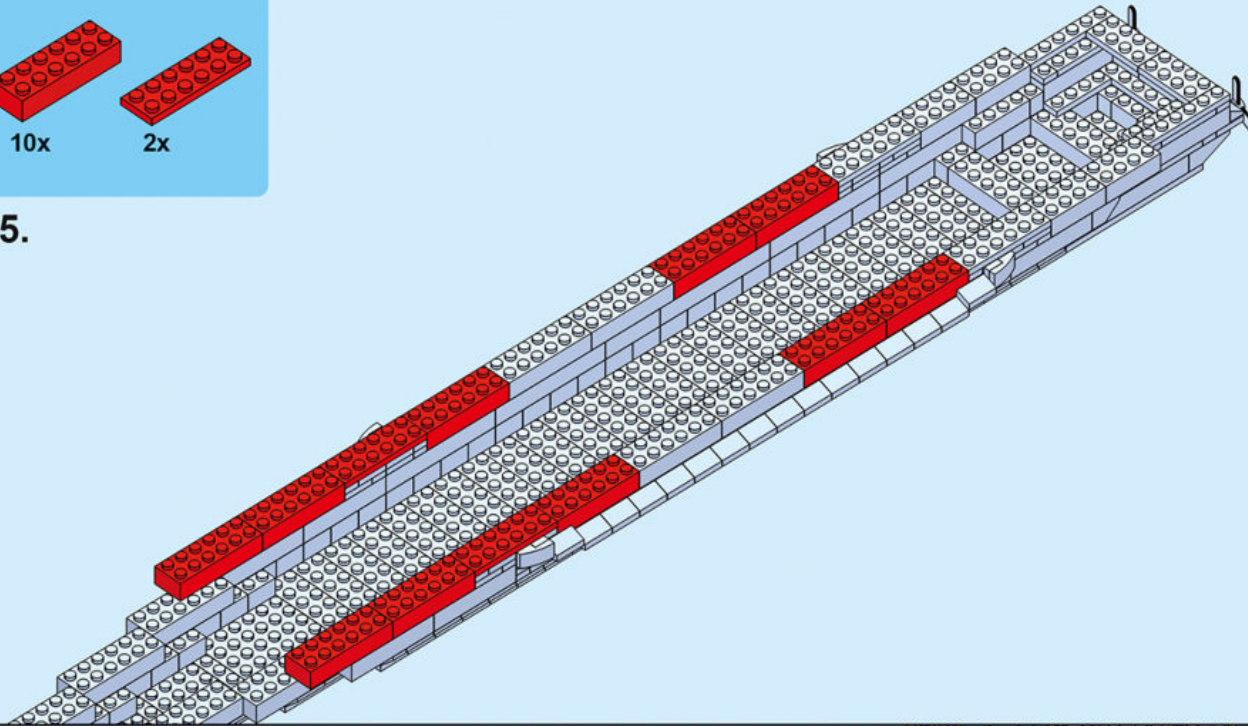

26.

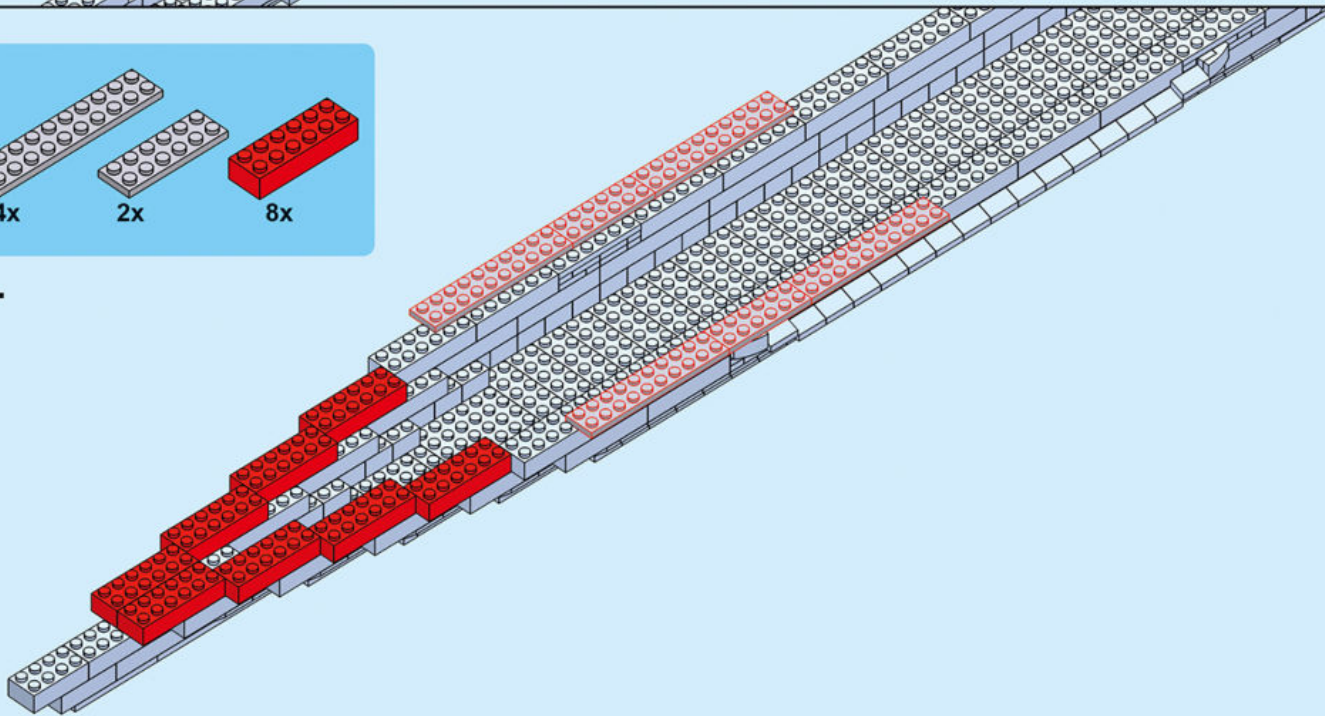

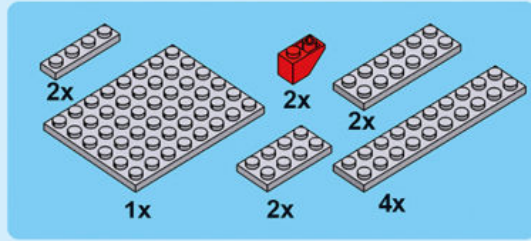

27.

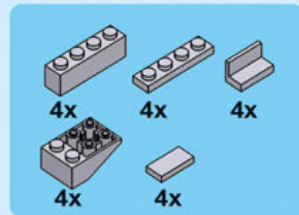
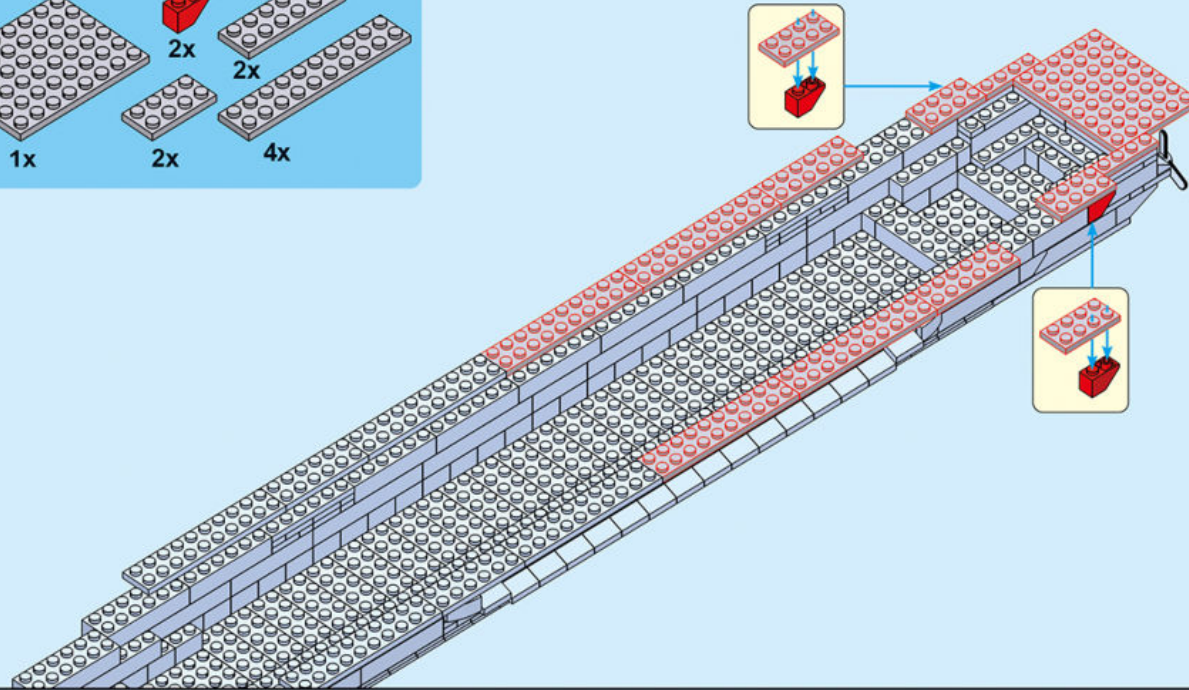

28.

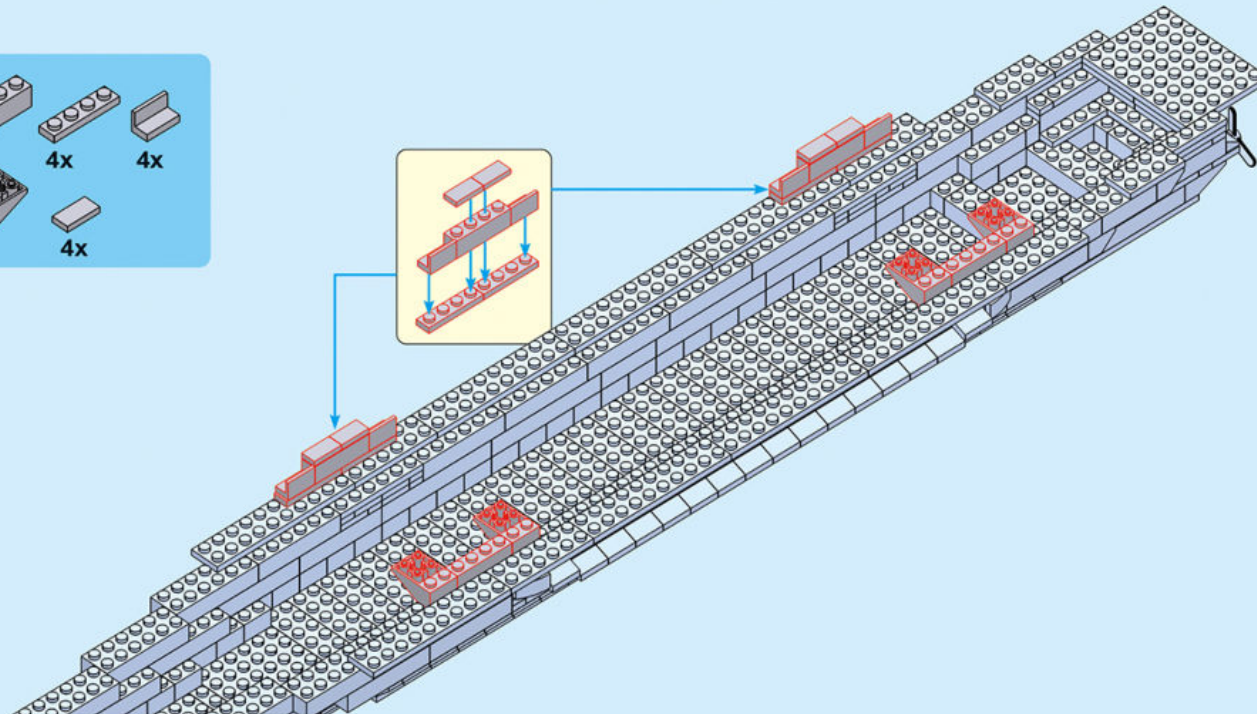

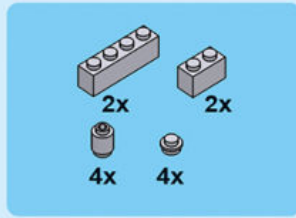

29.

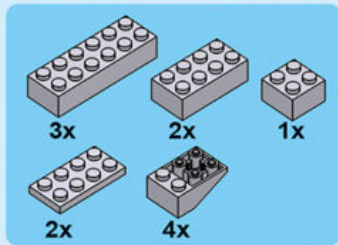
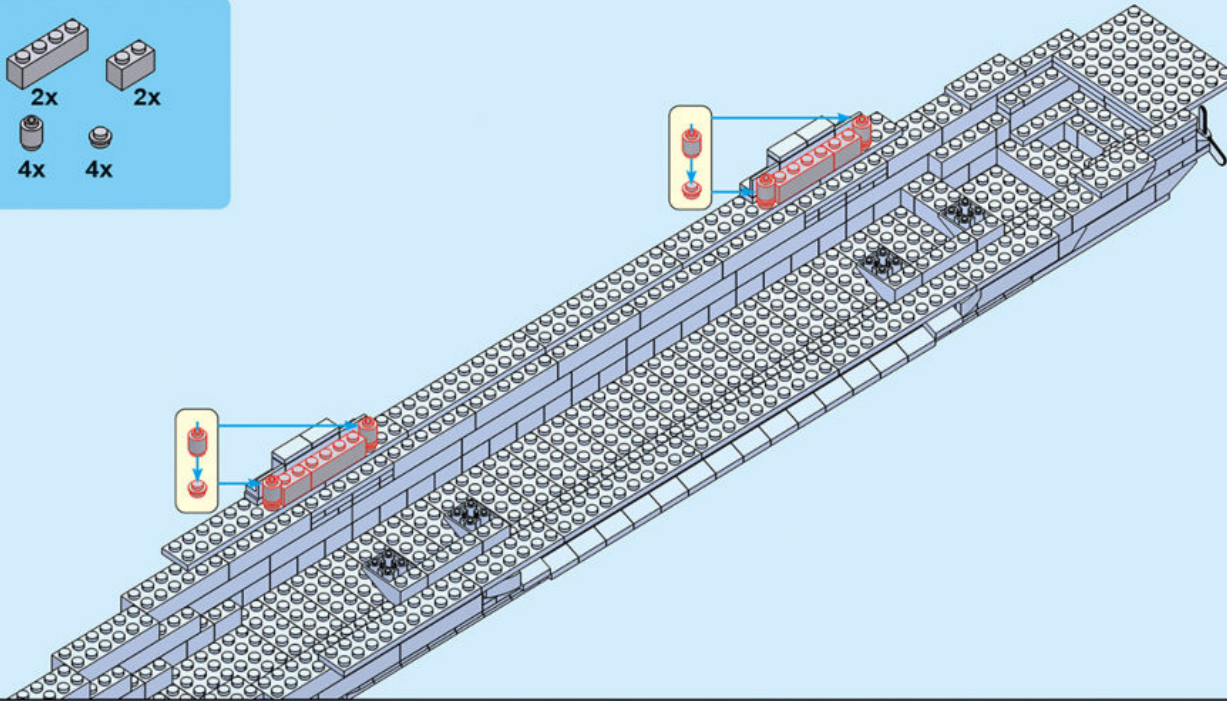

30.

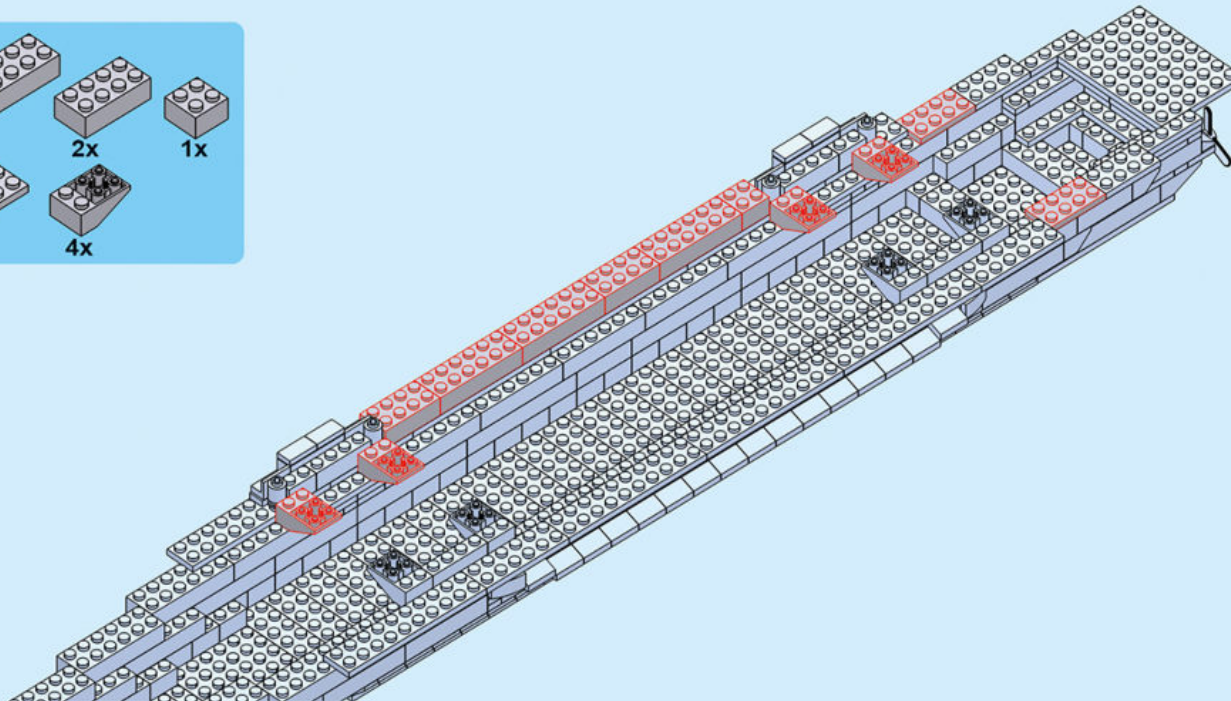

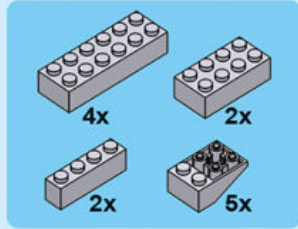

31.

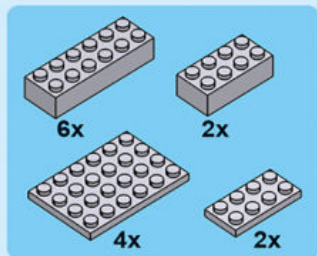
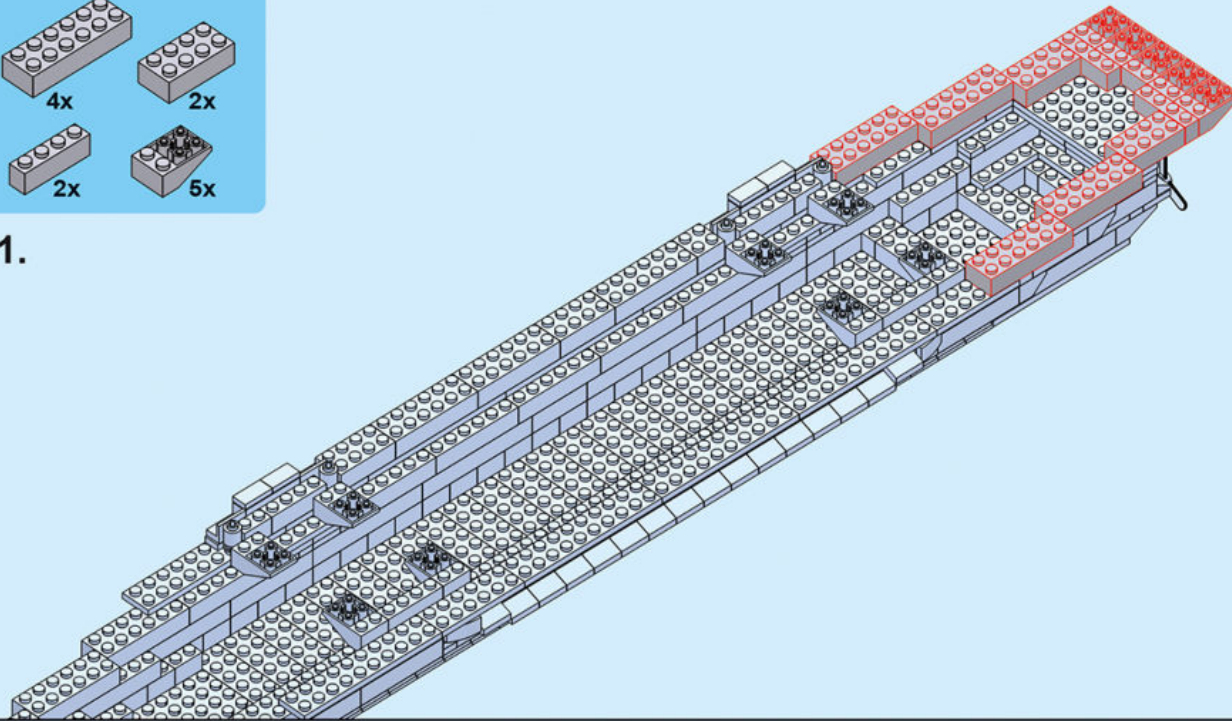

32.

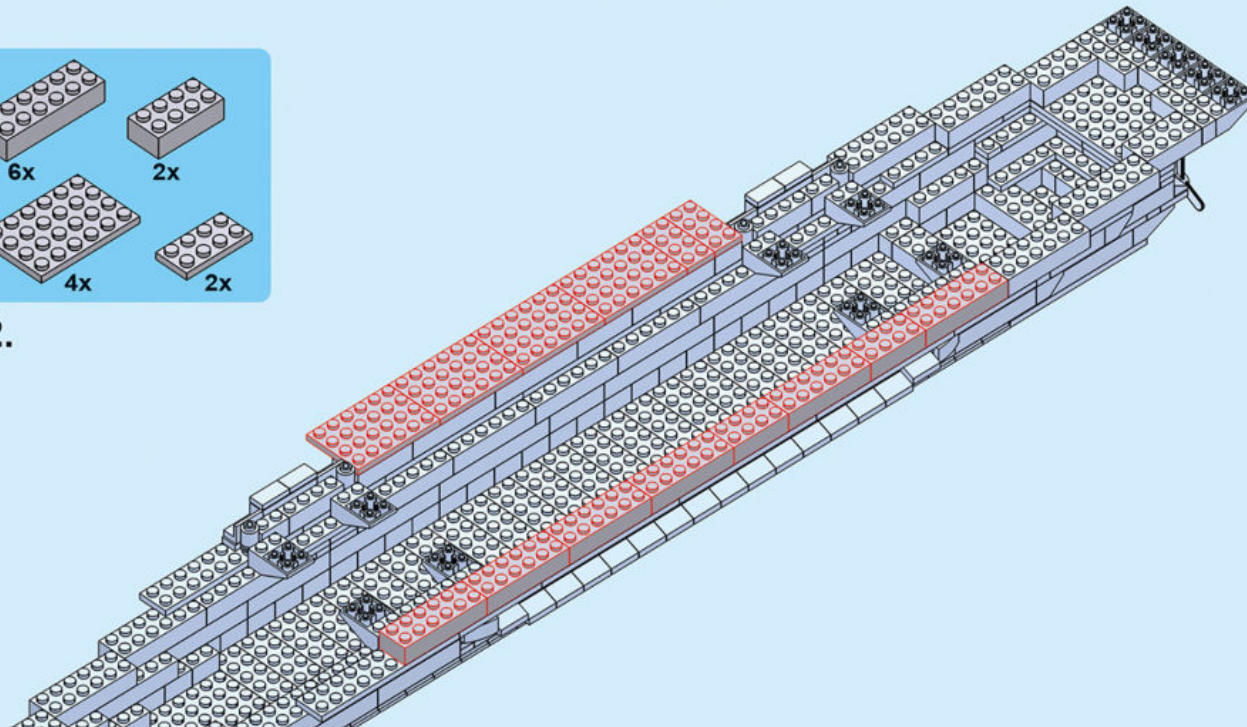

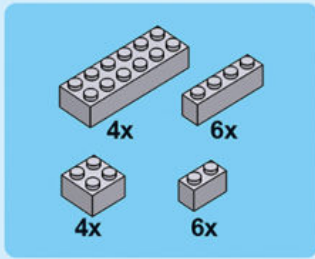

33.

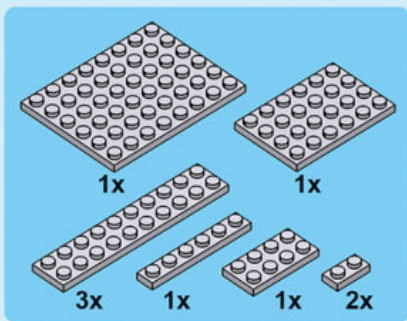
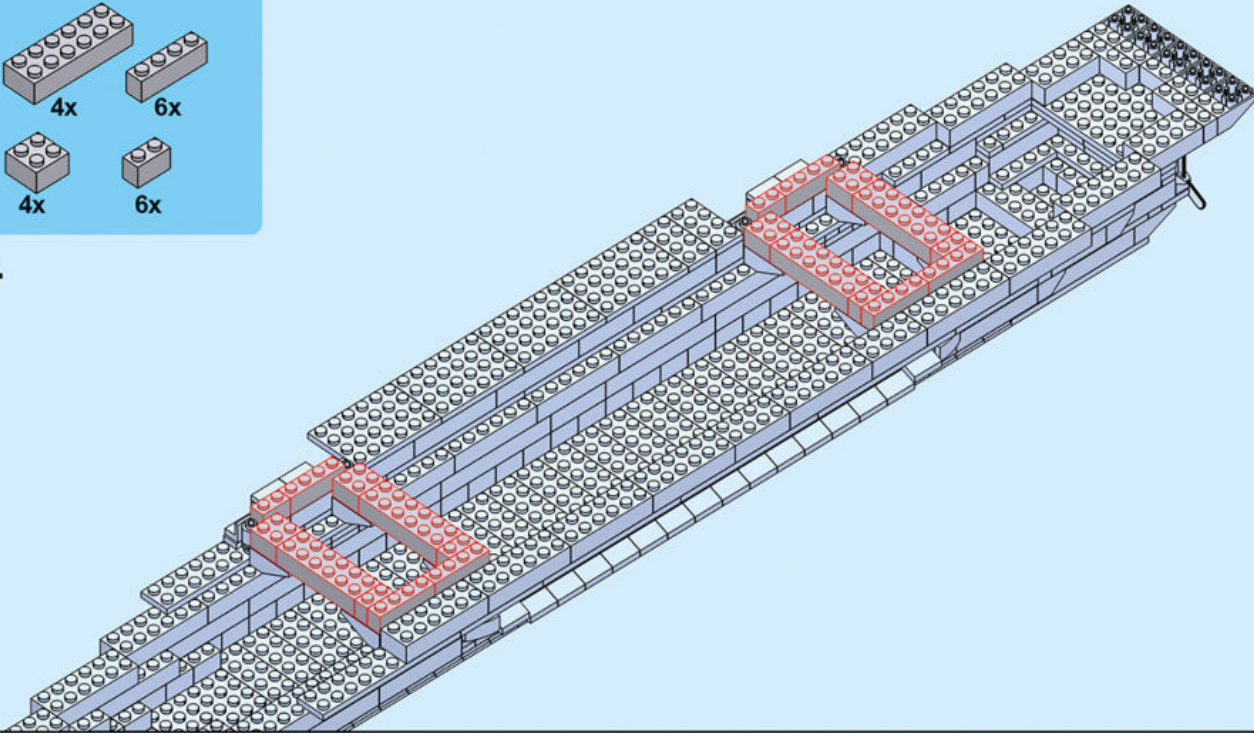

34.

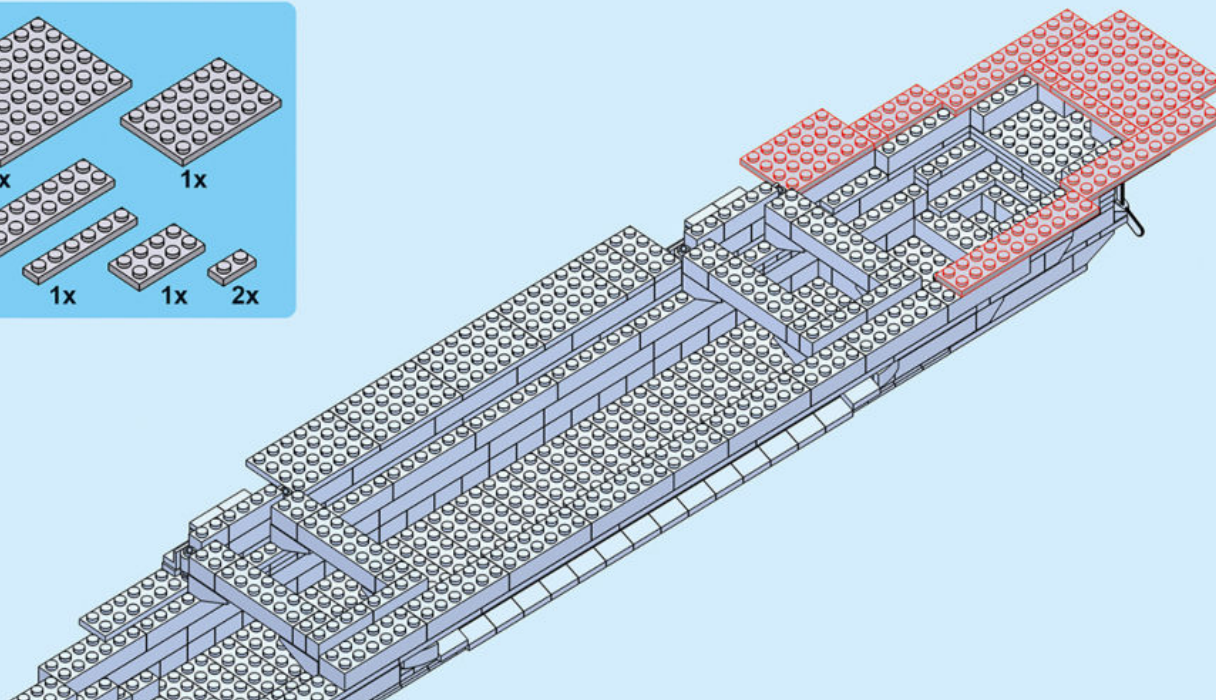

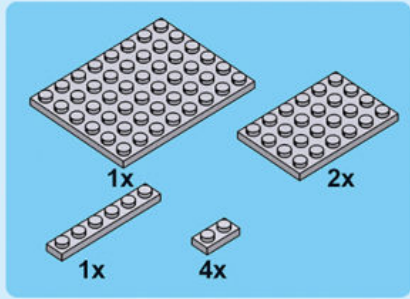

35.

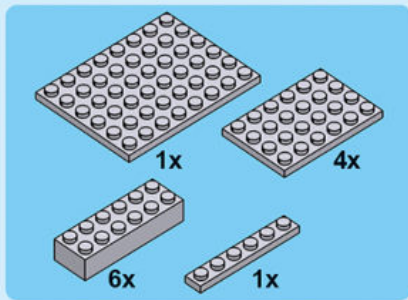
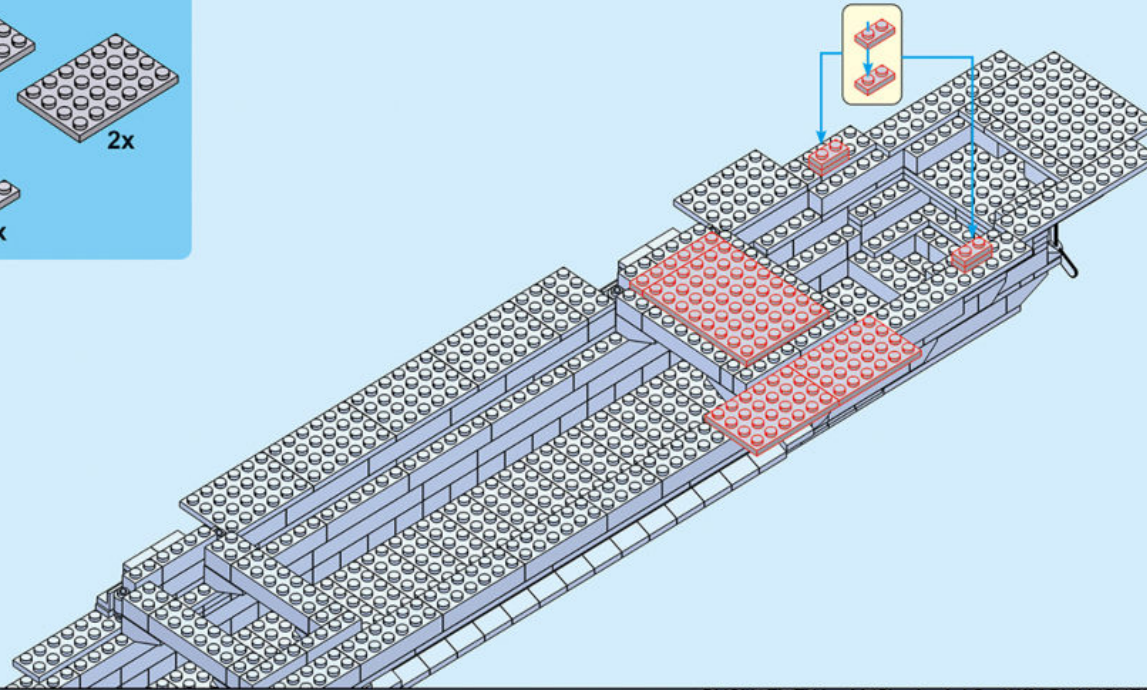

36.

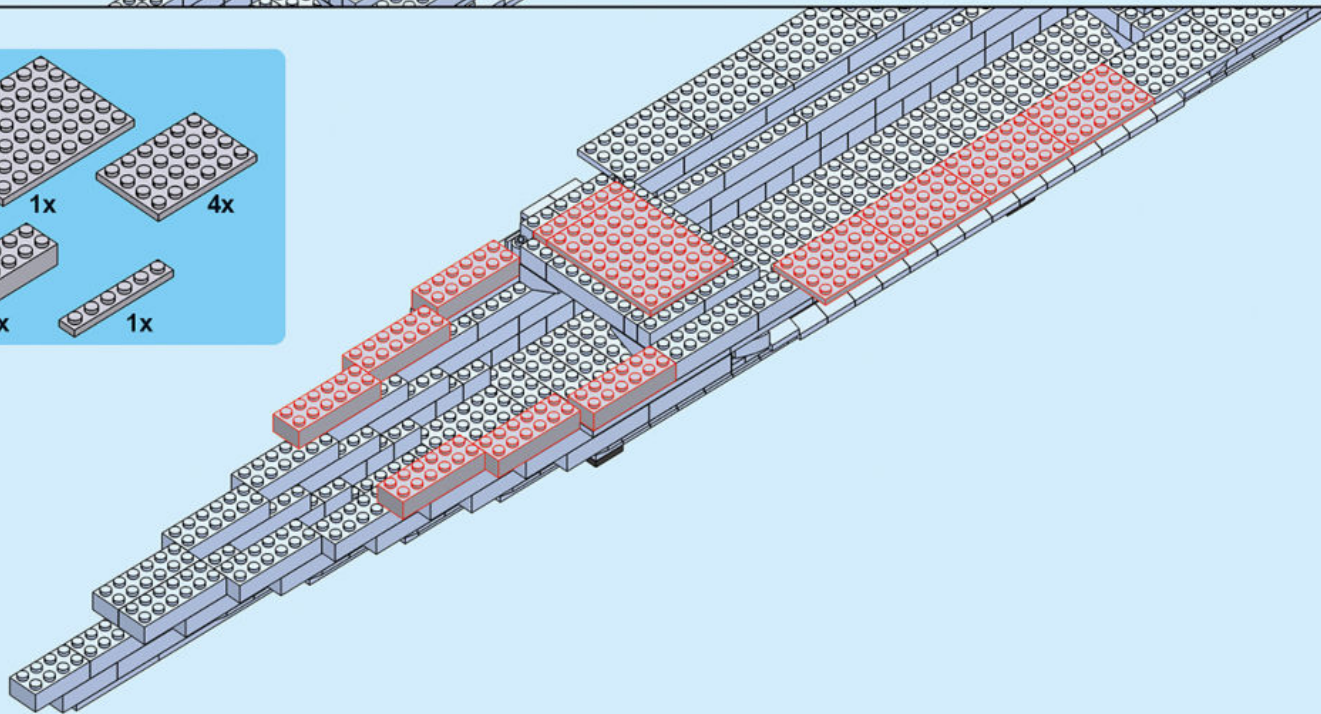



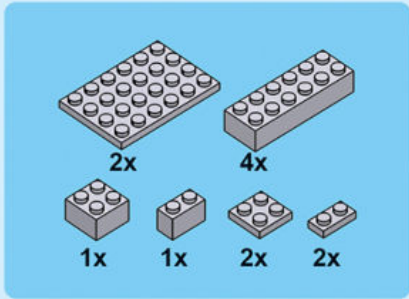

37.

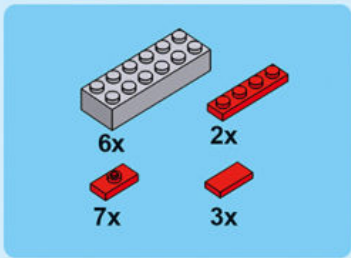
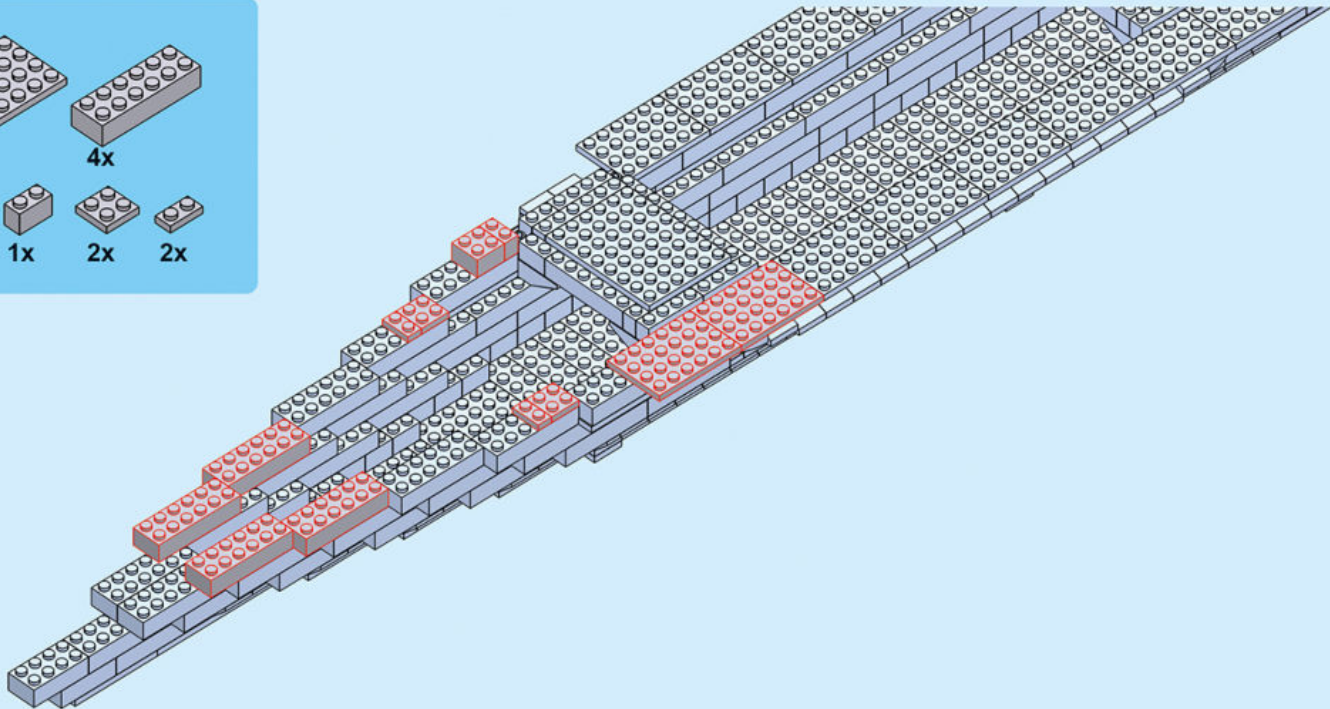

38.

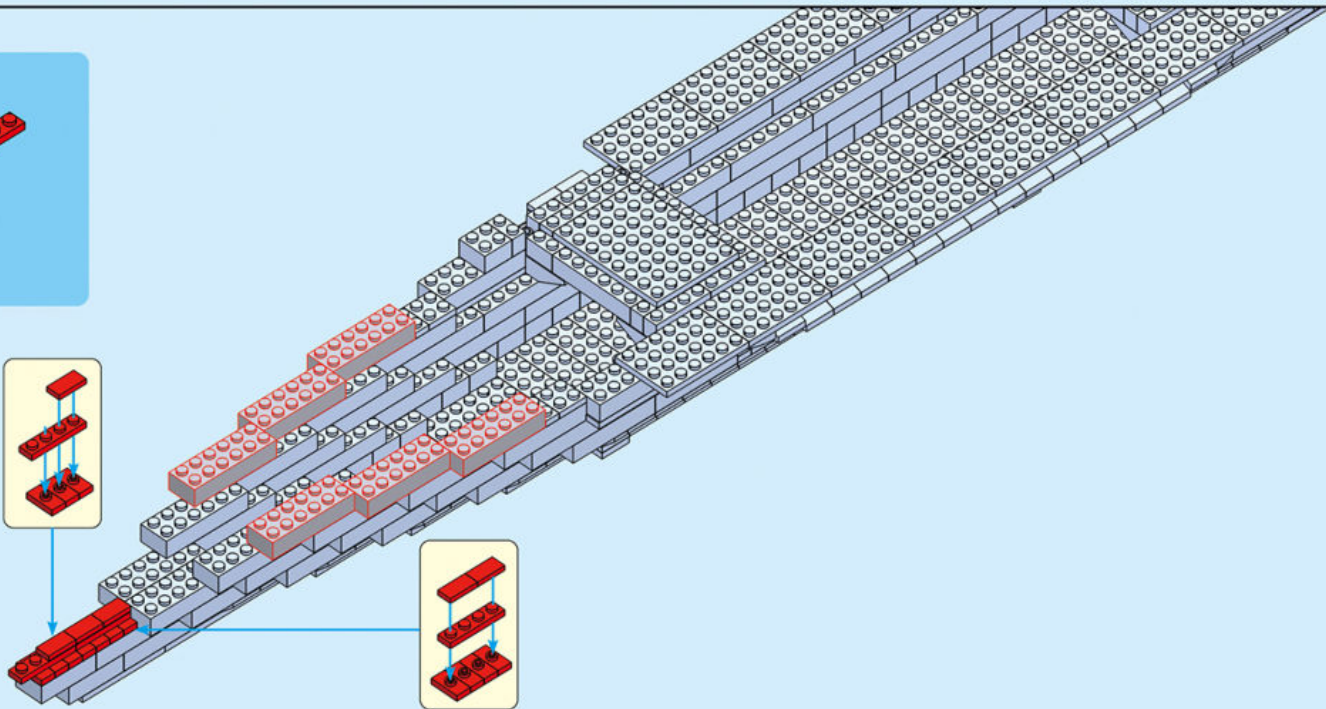

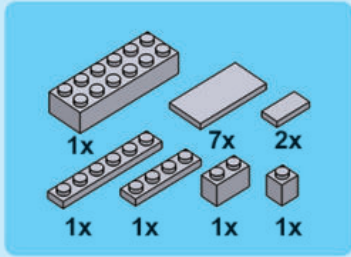

39.

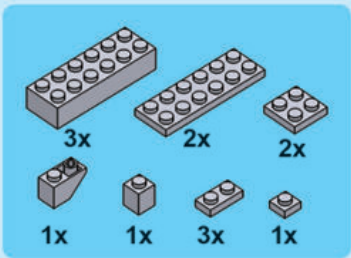
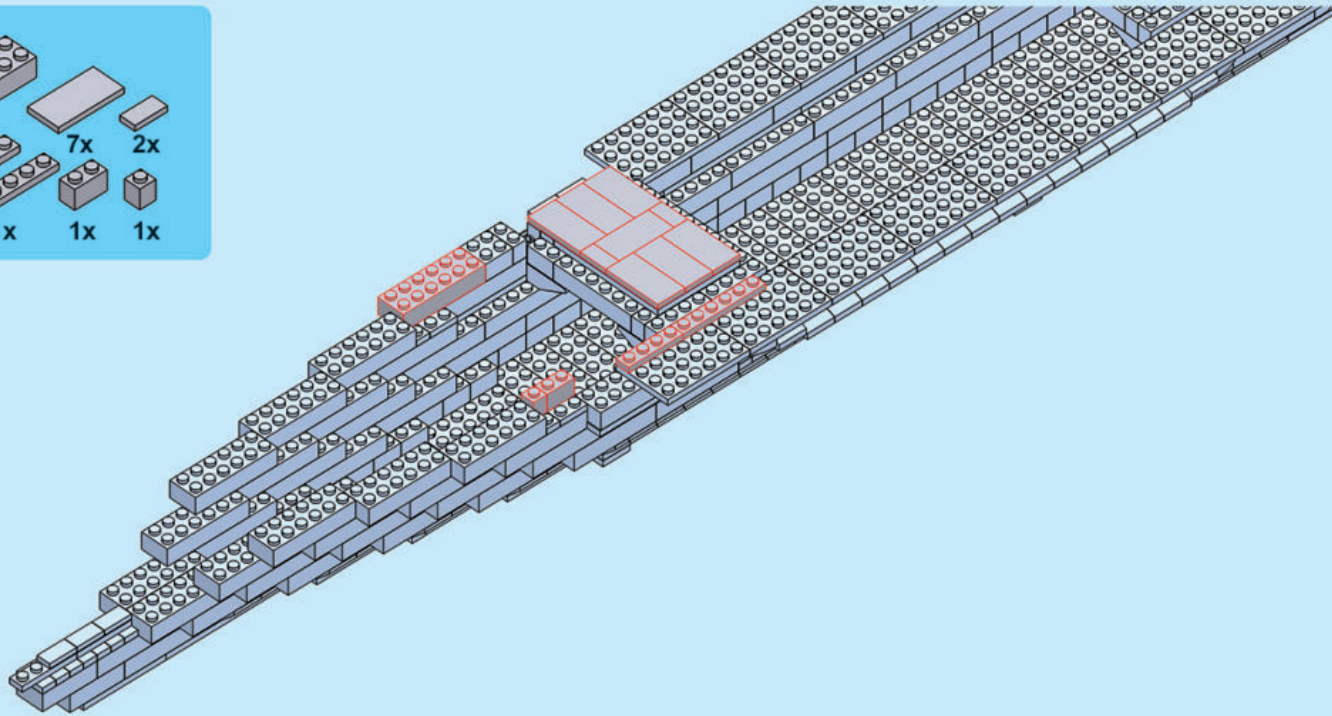

40.

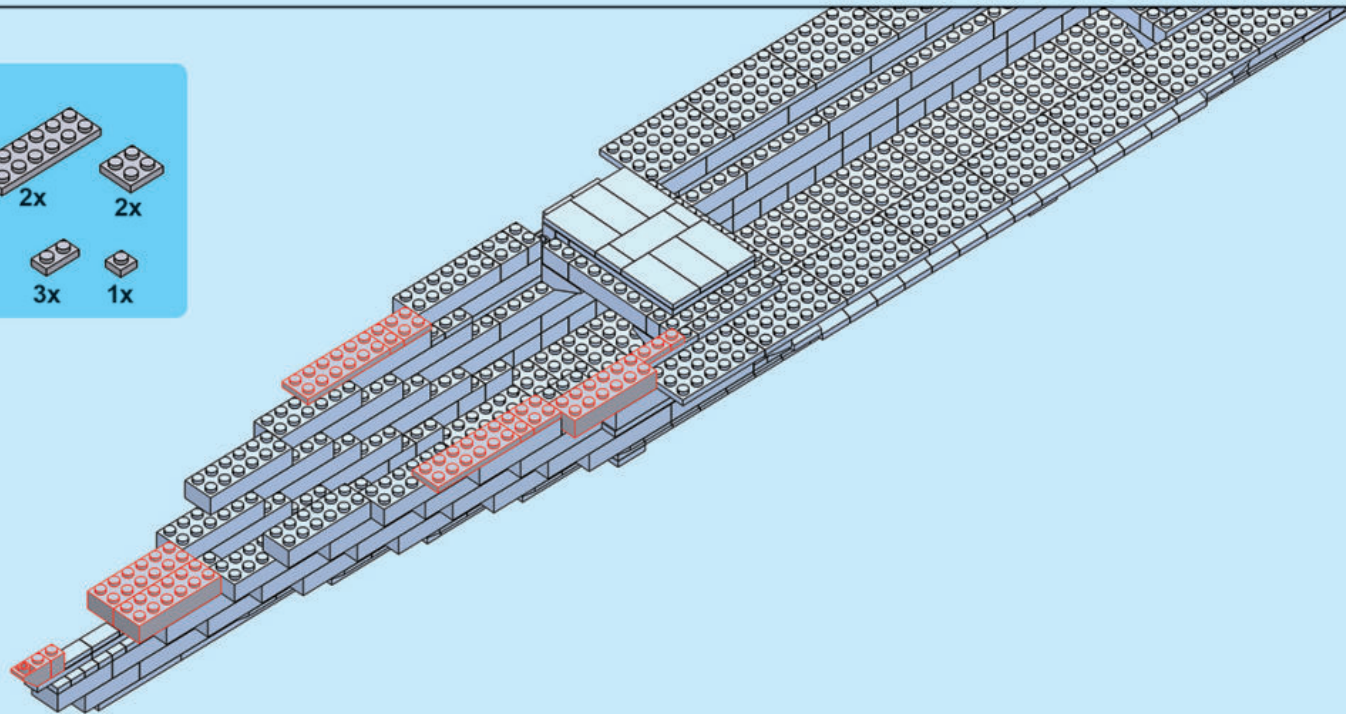

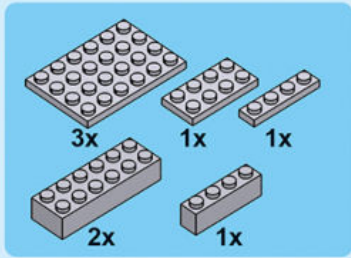

41.

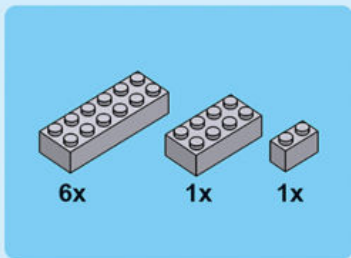
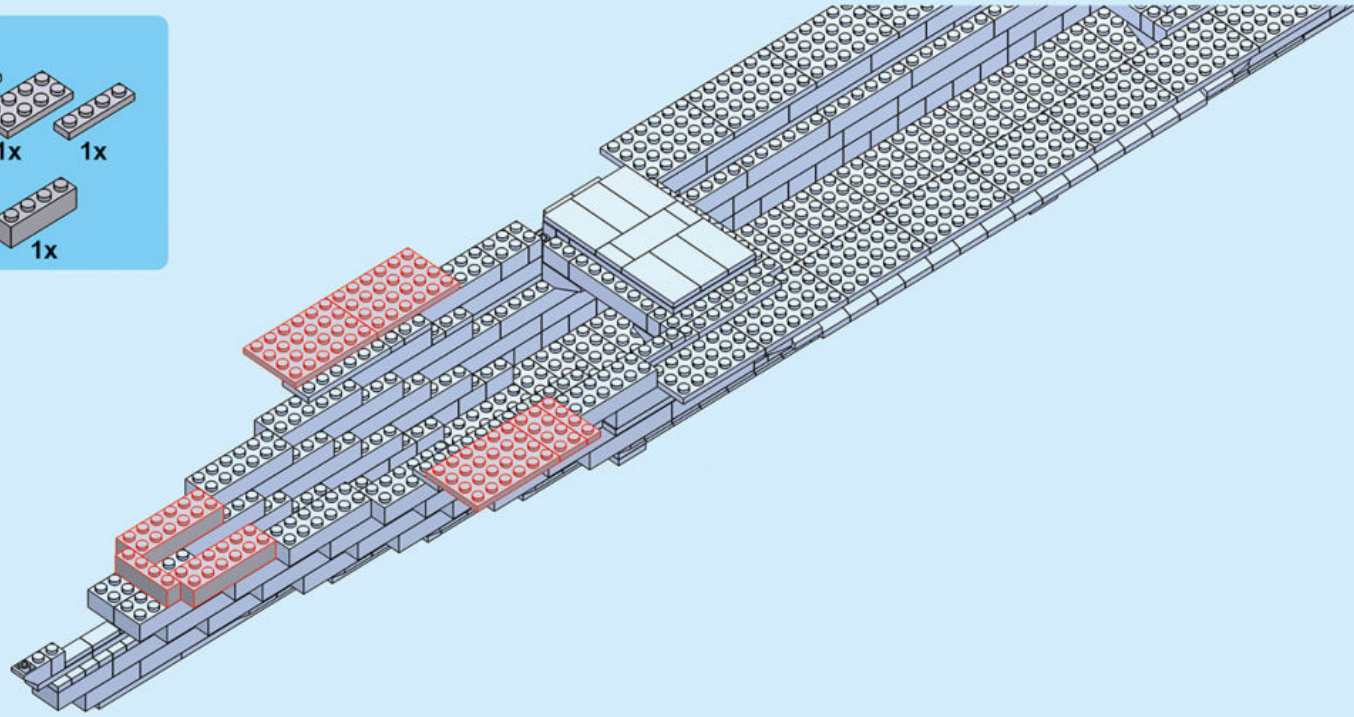

42.

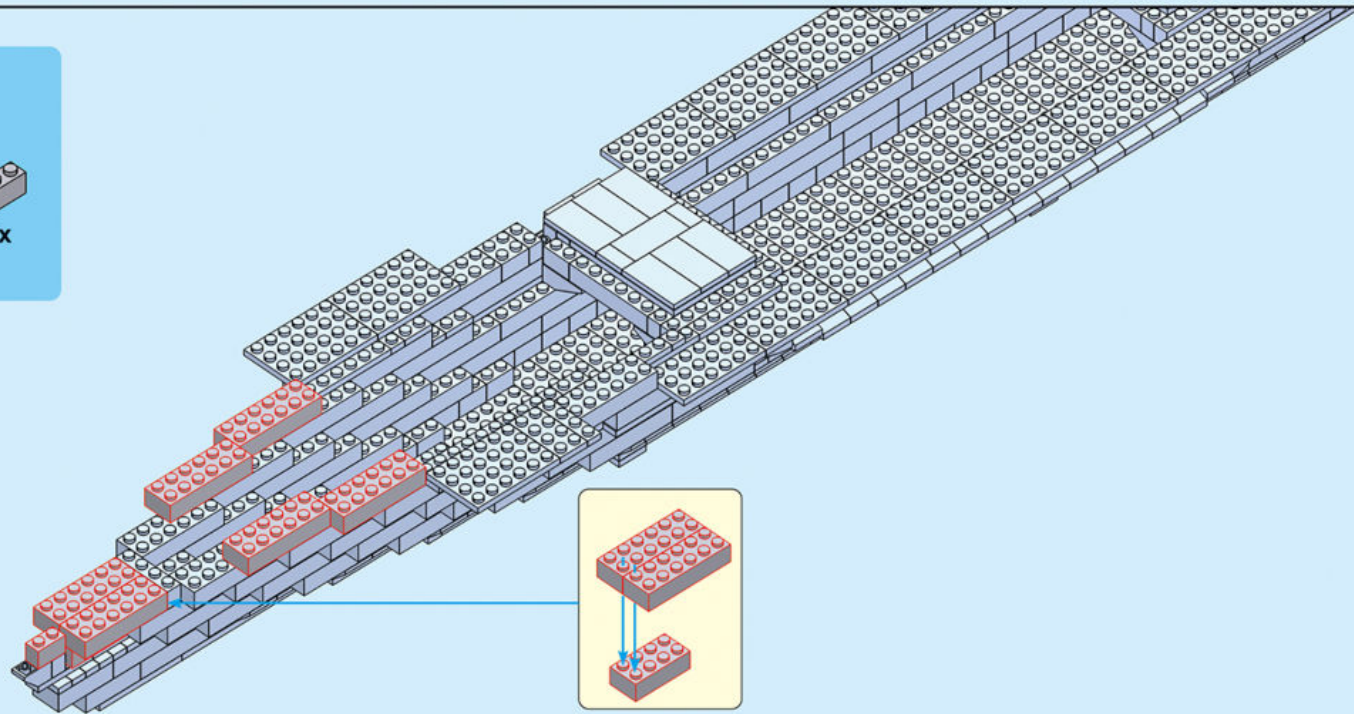

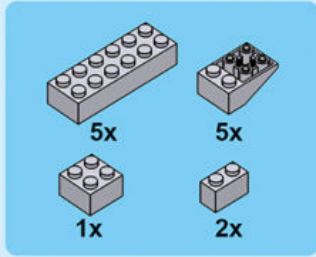

43.

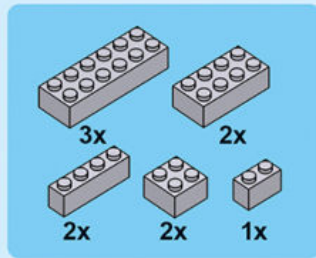
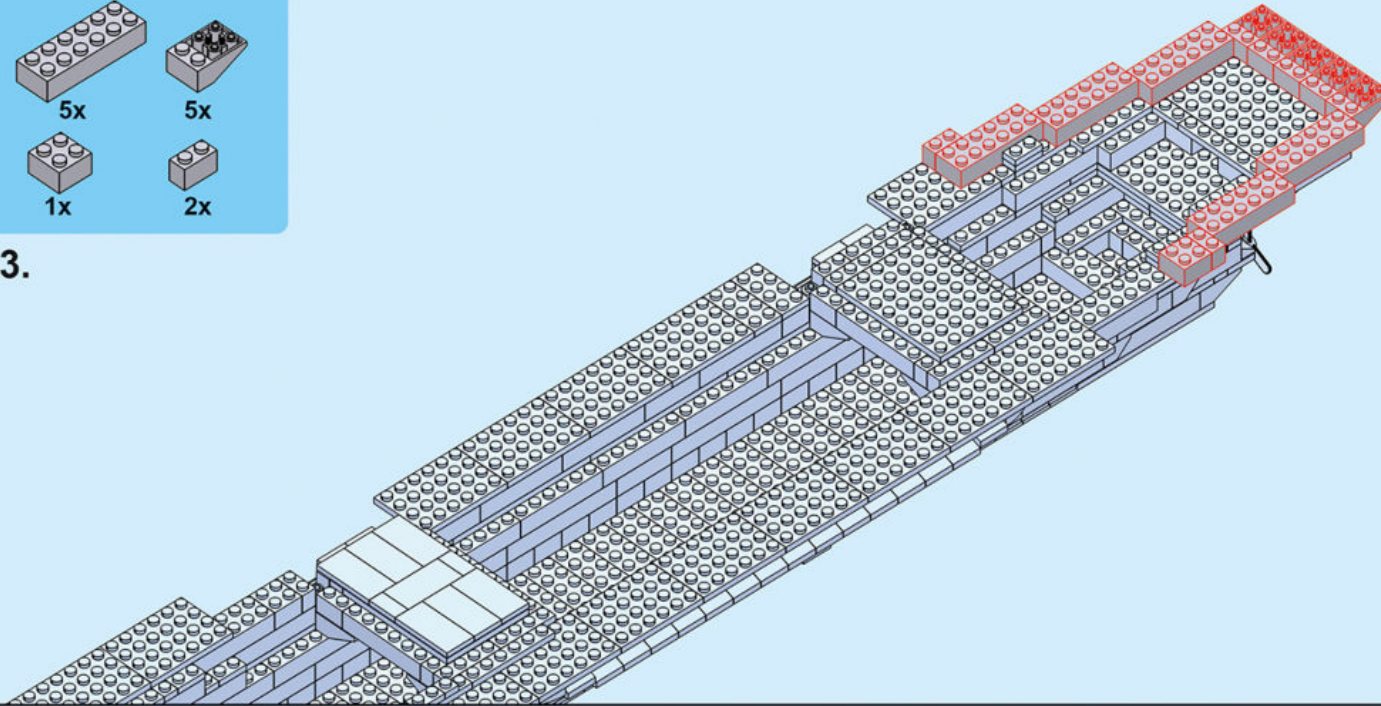

44.

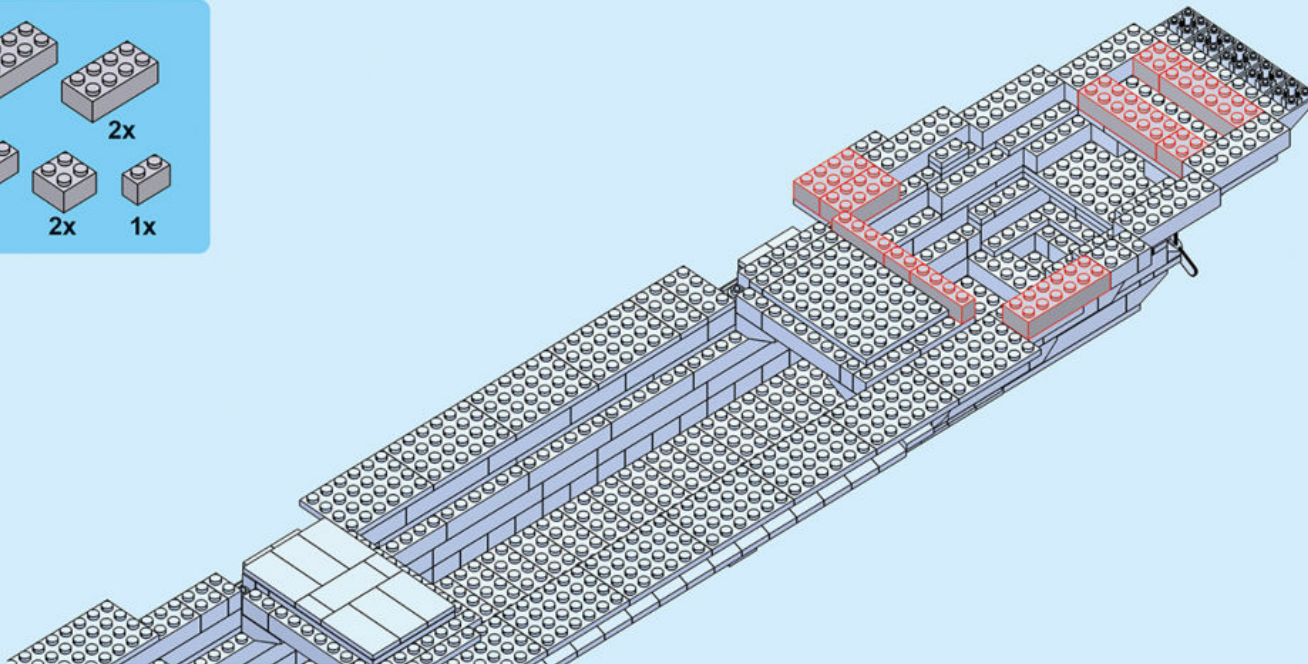

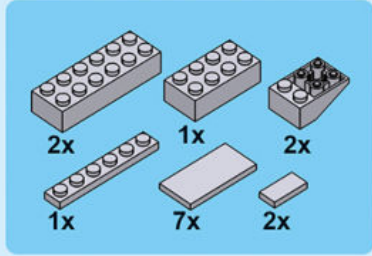

45.

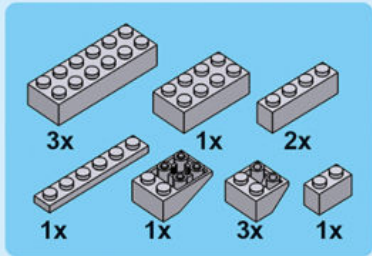
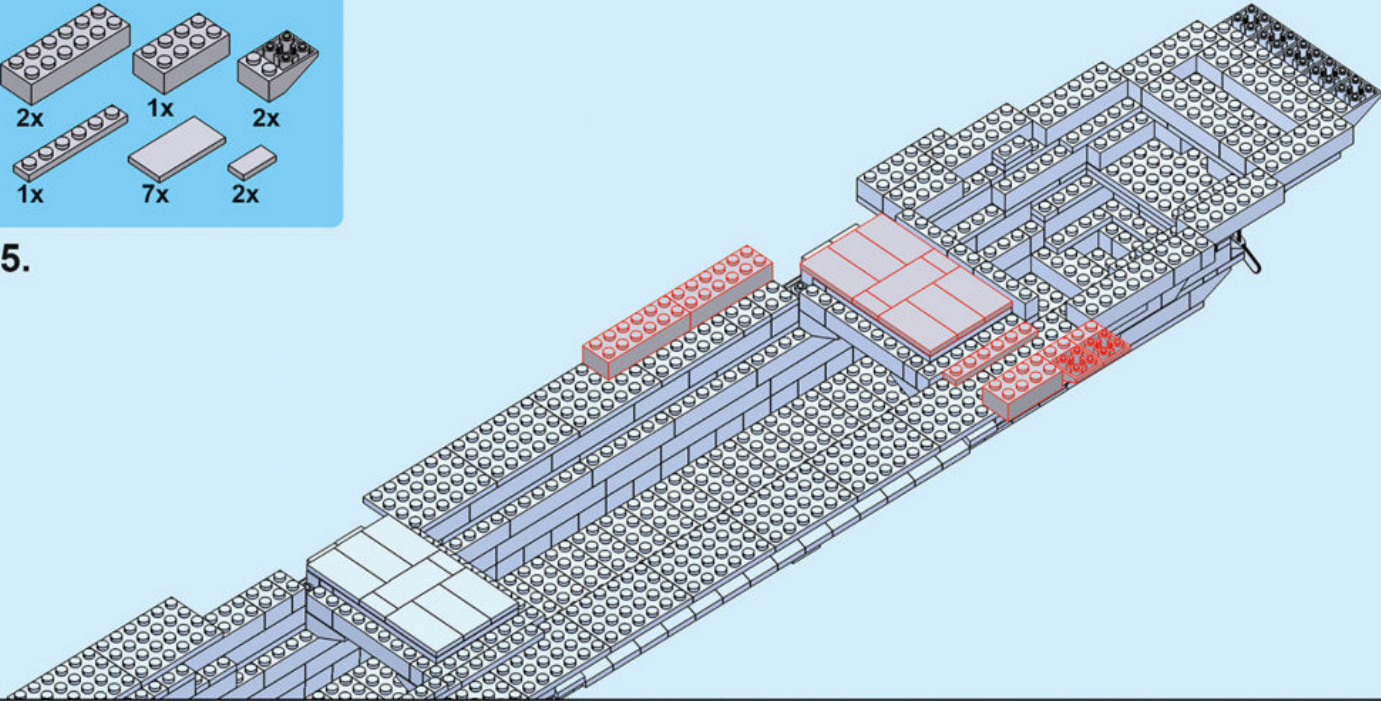

46.

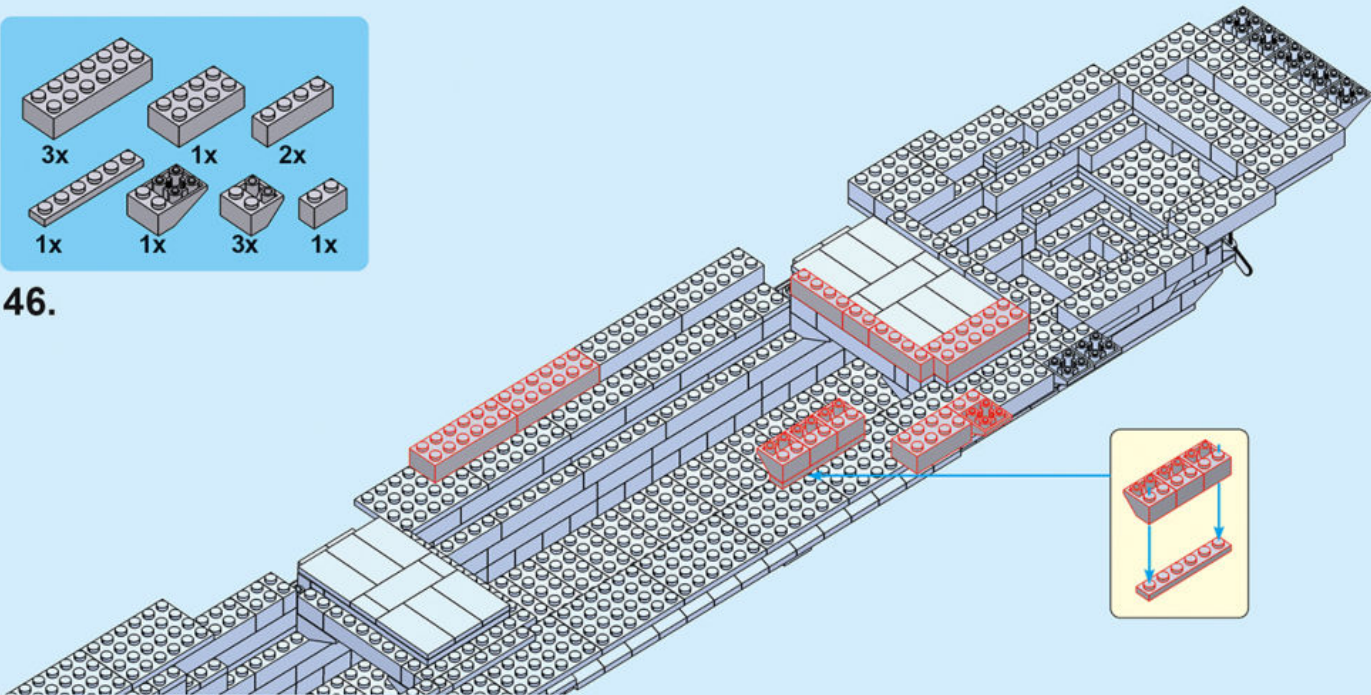

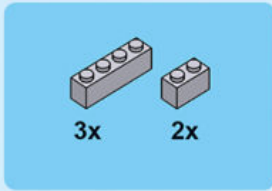

47.

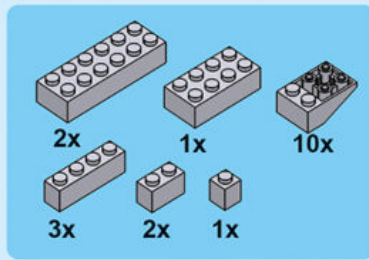
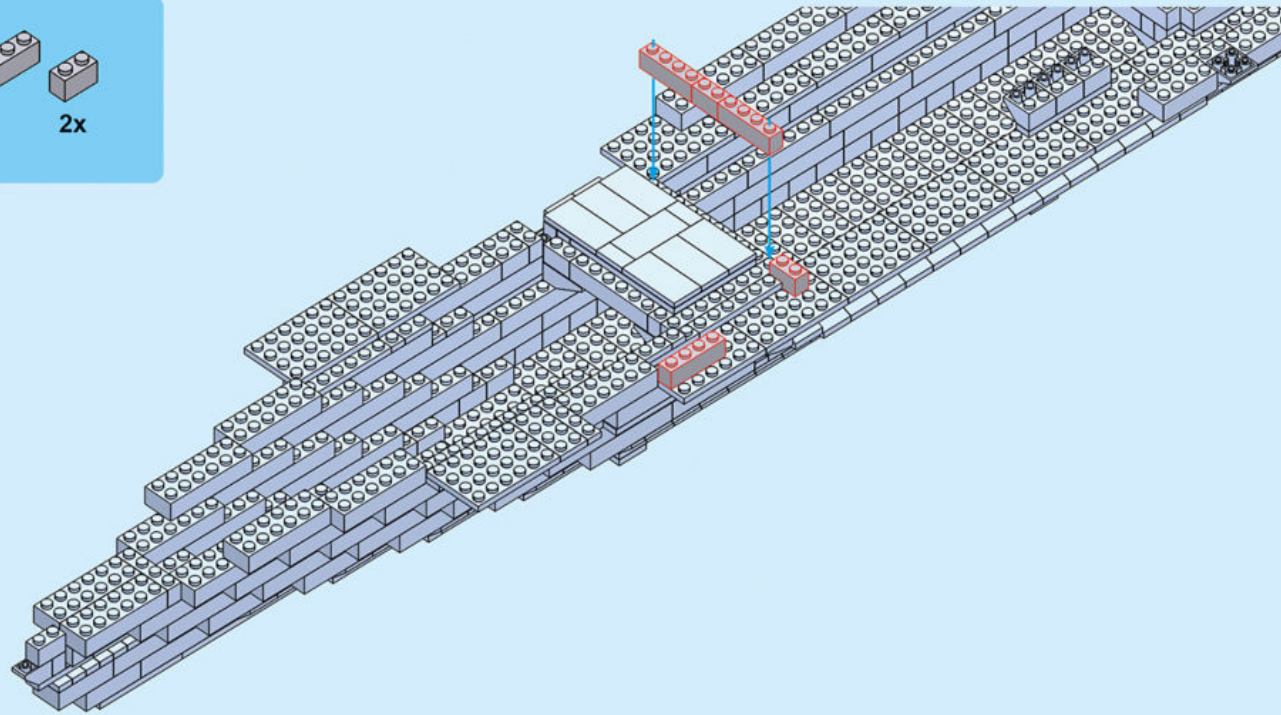

48.

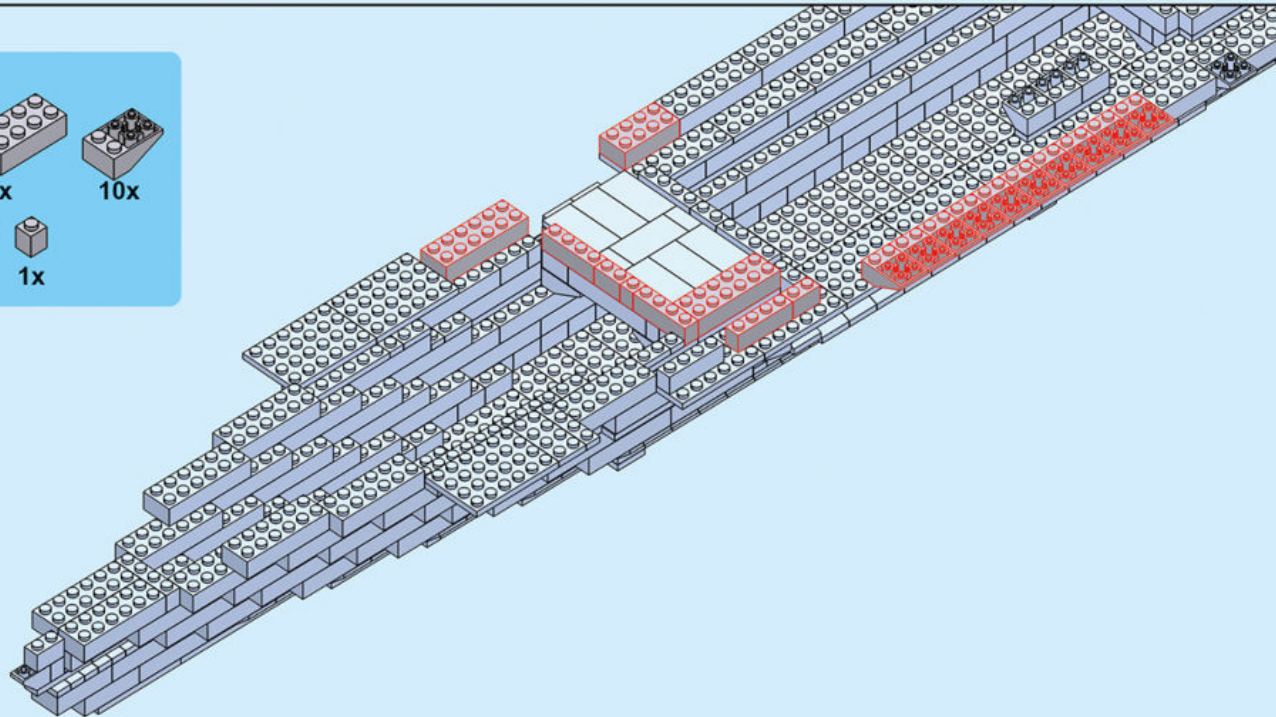

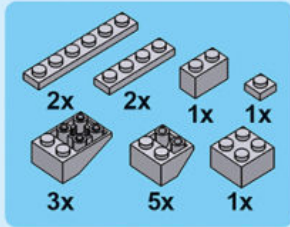

49.

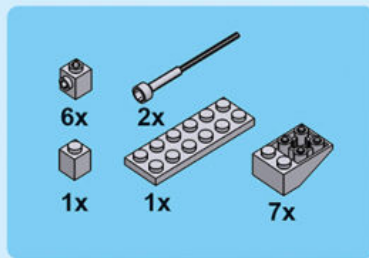
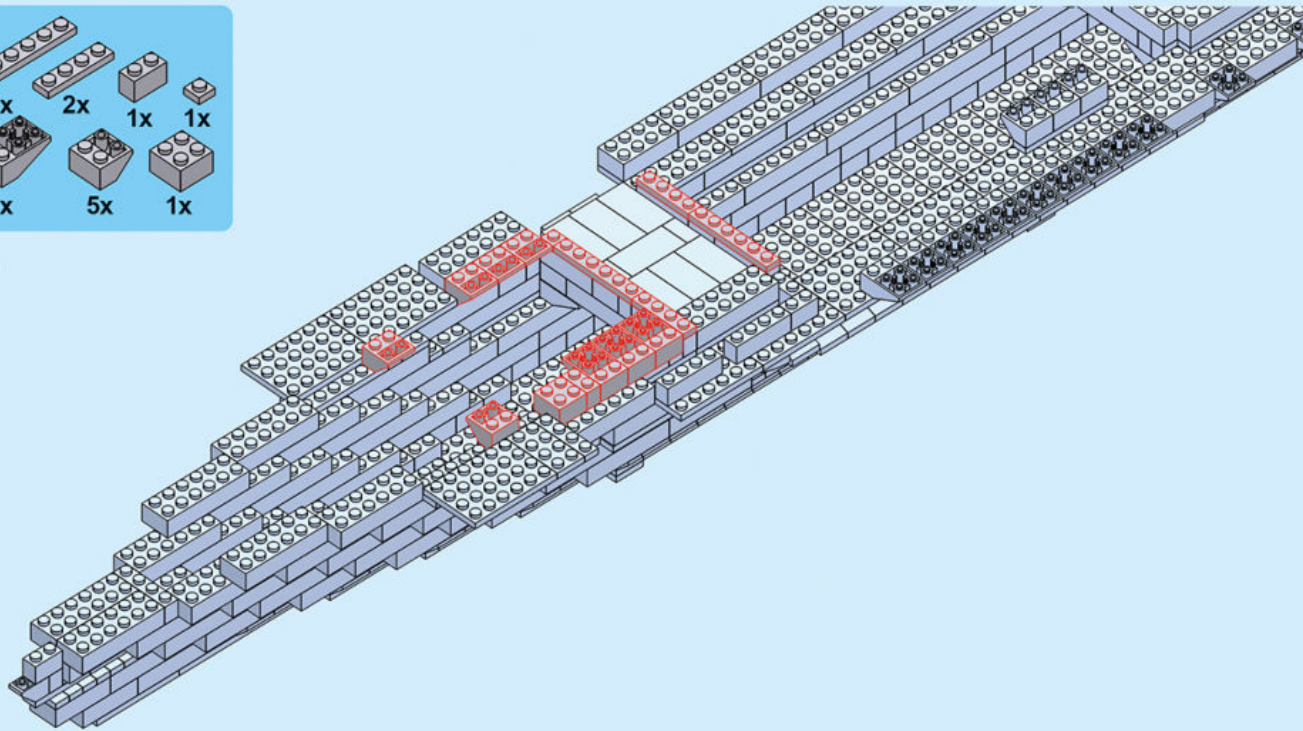

50.

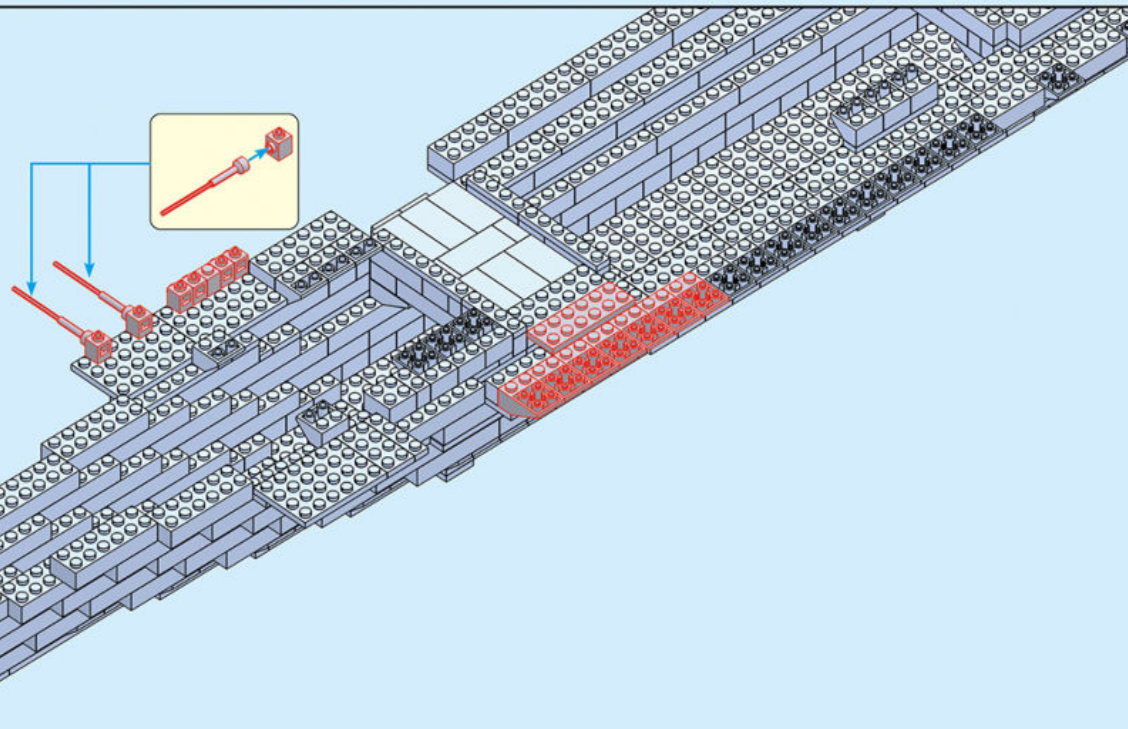

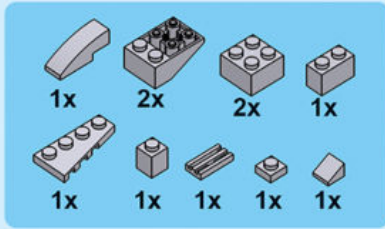

51.

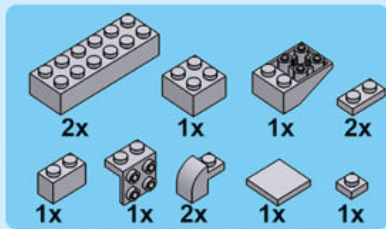
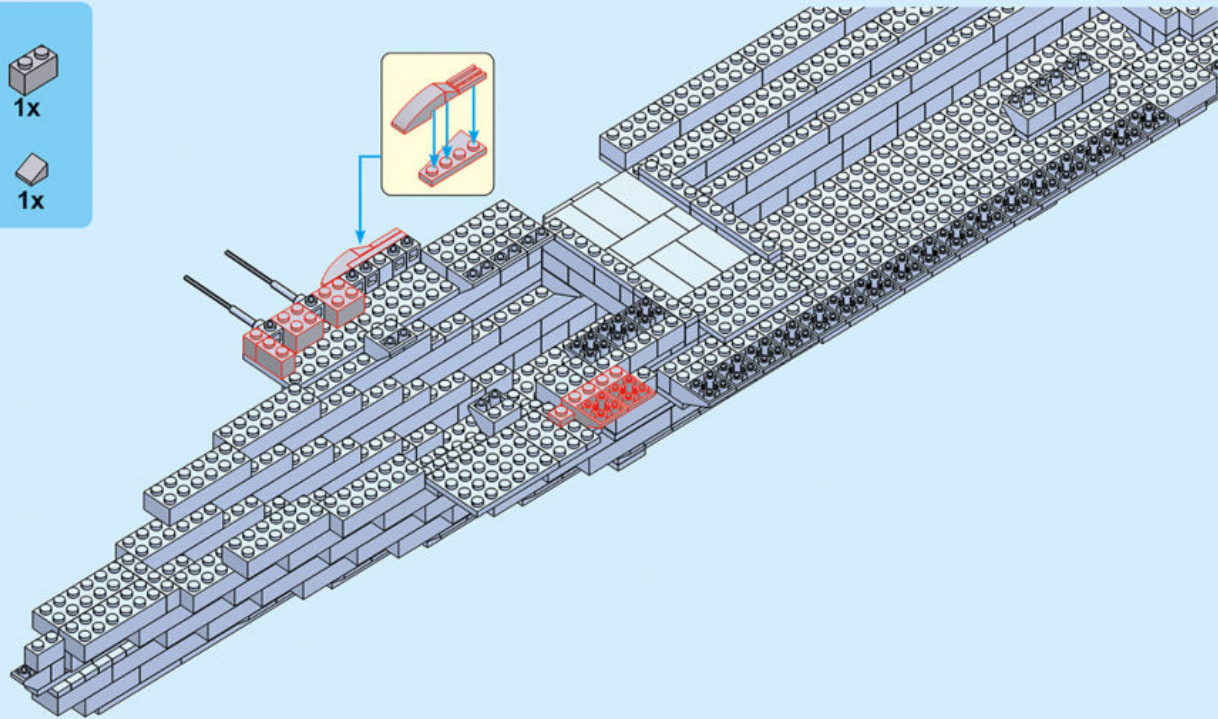

52.

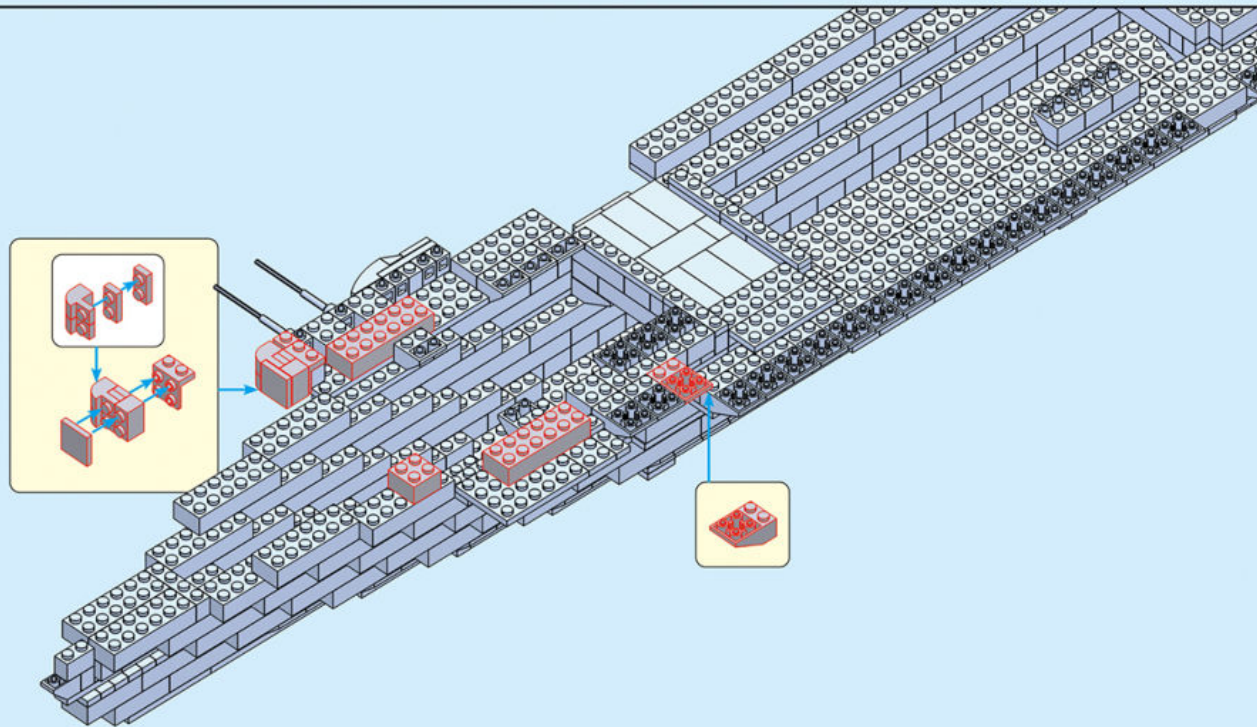



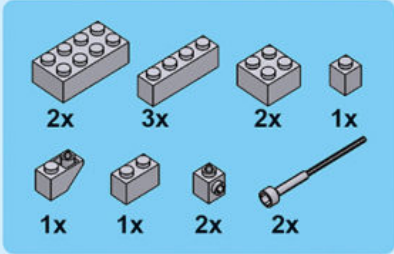

53.

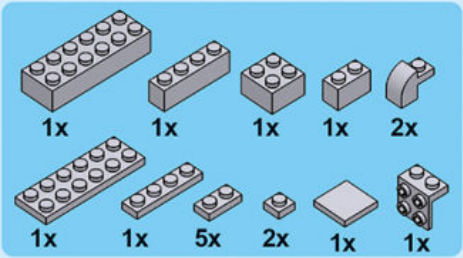
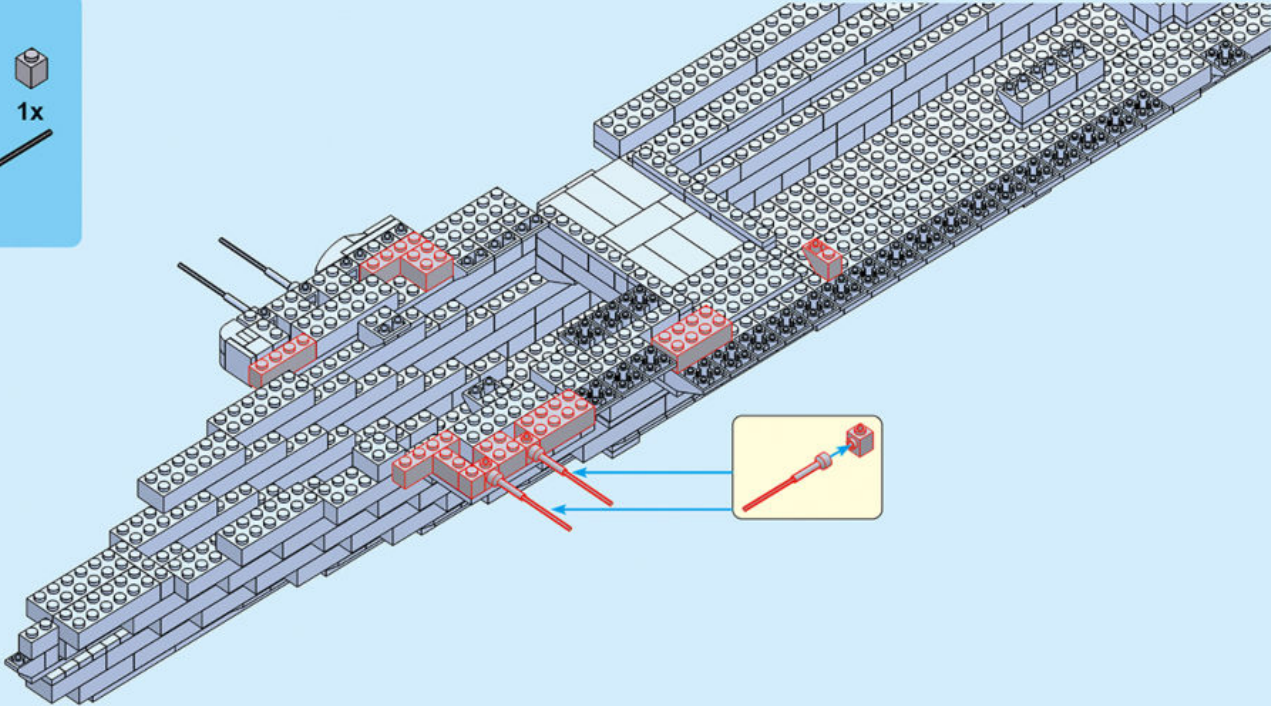

54.

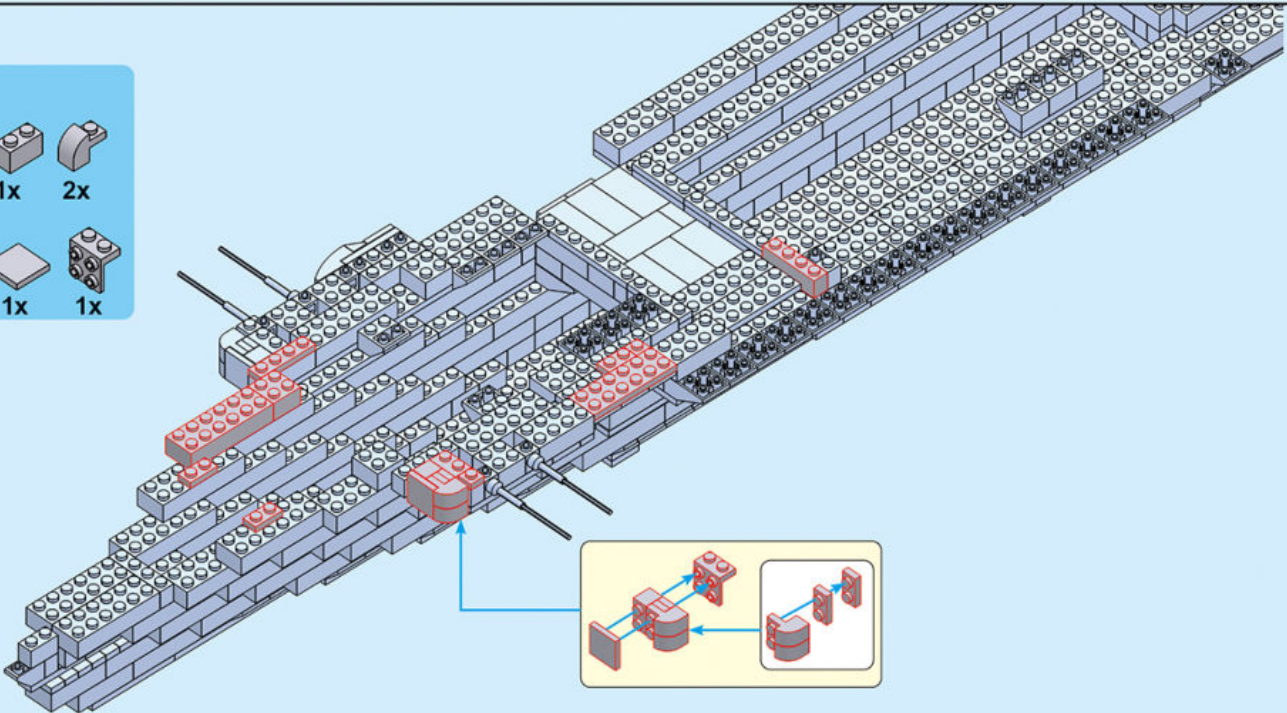



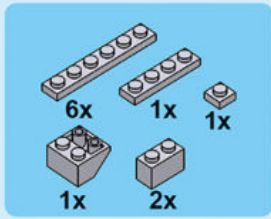

57.

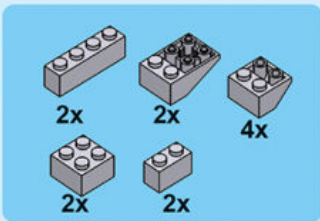
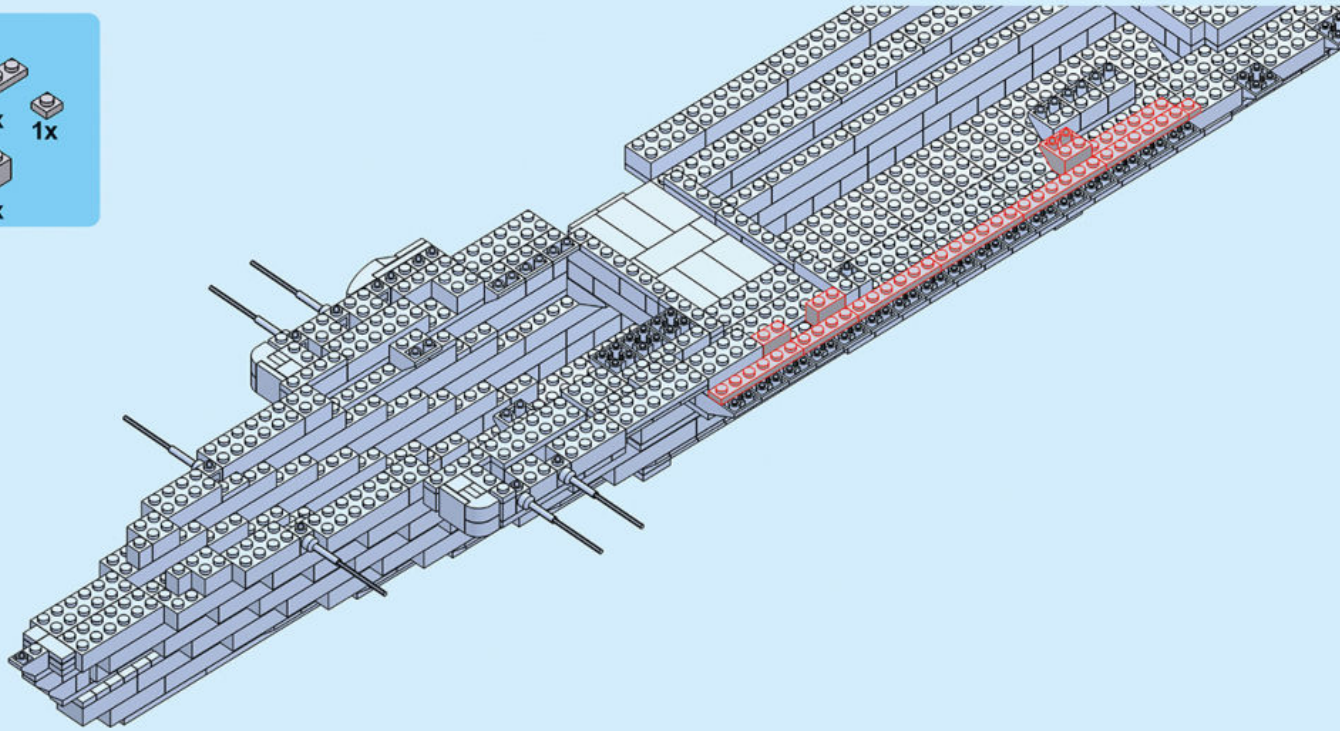

58.

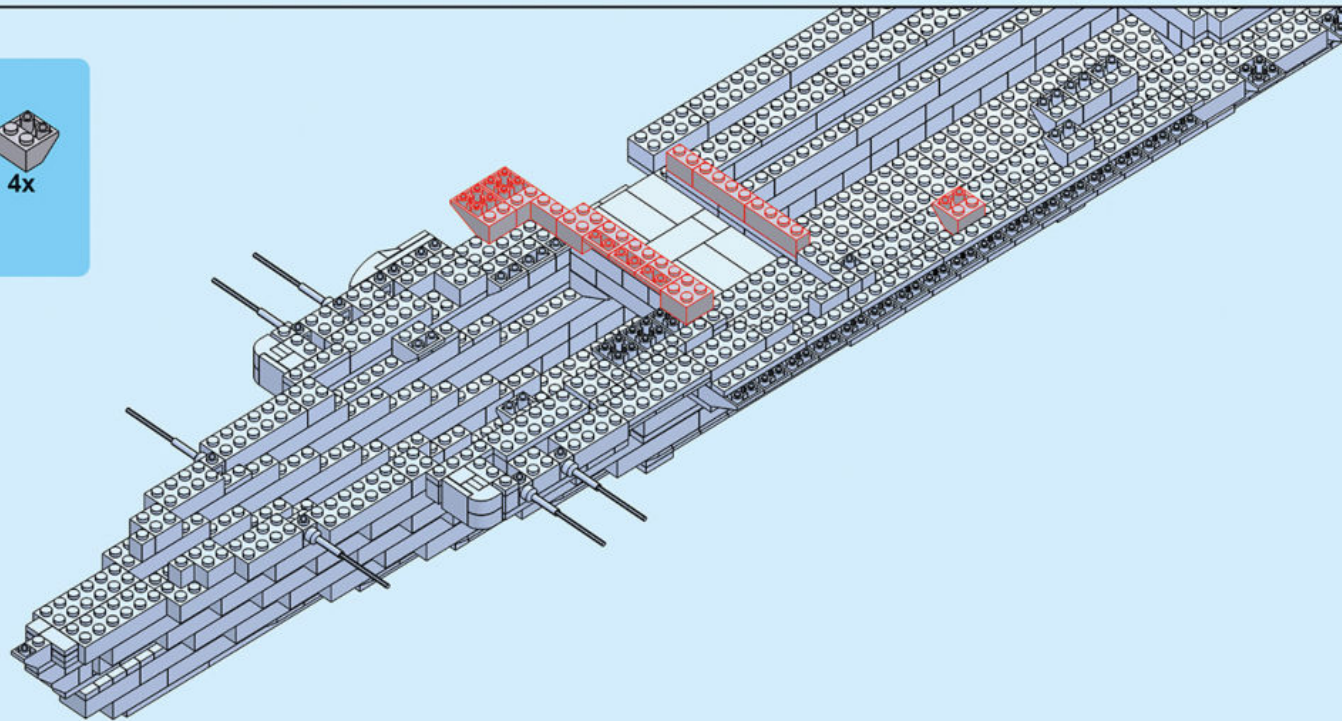

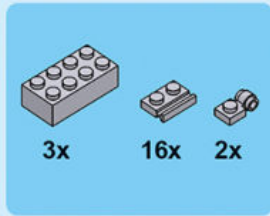

59.

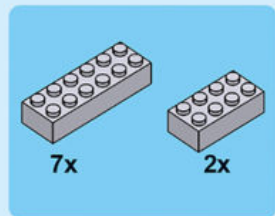
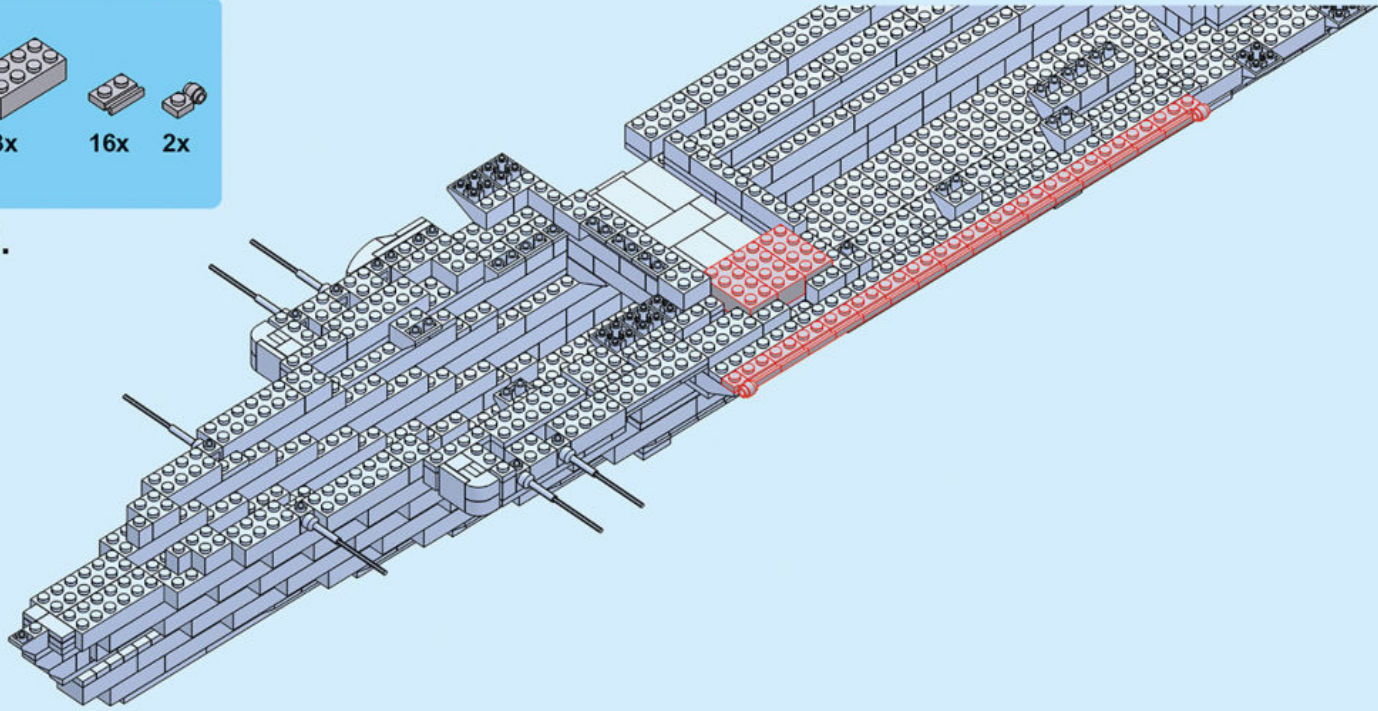

60.

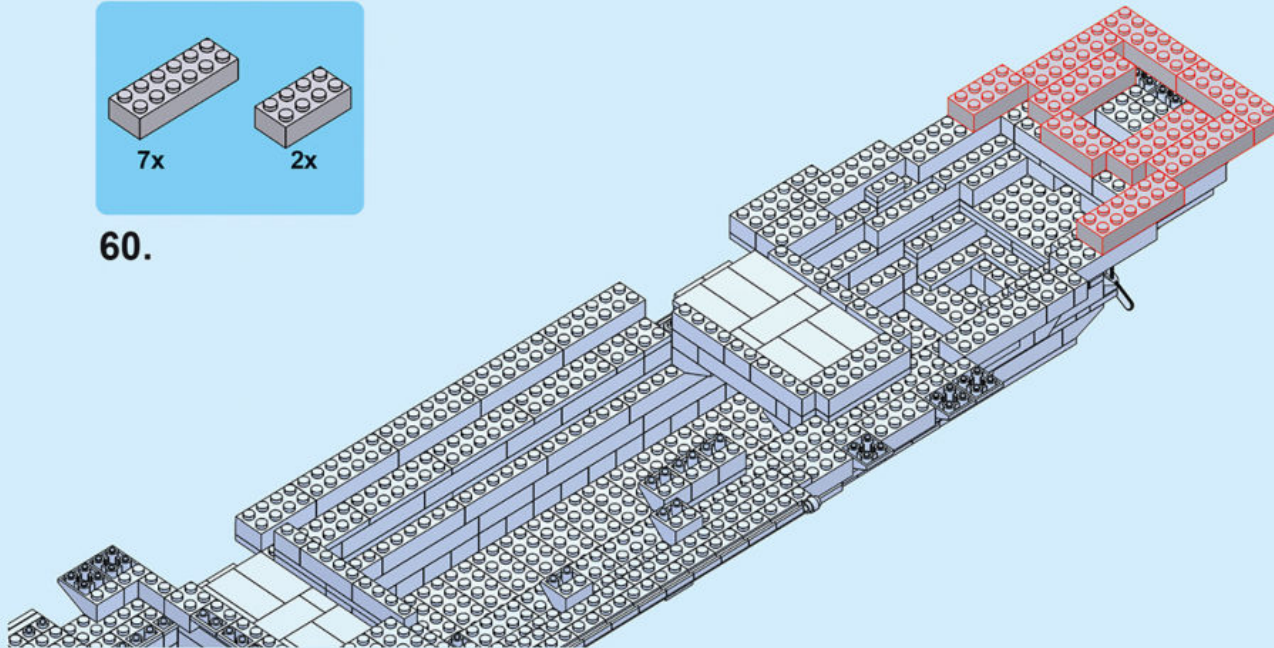

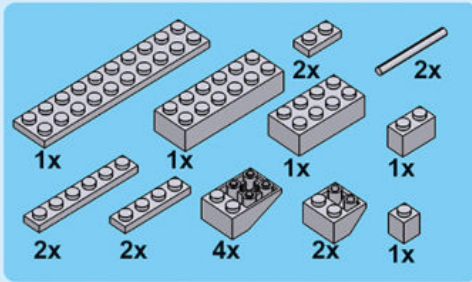

61.

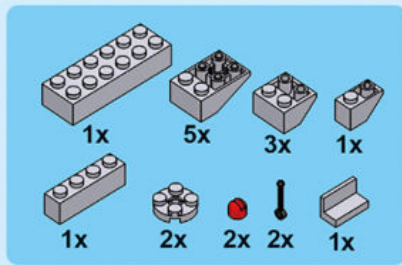
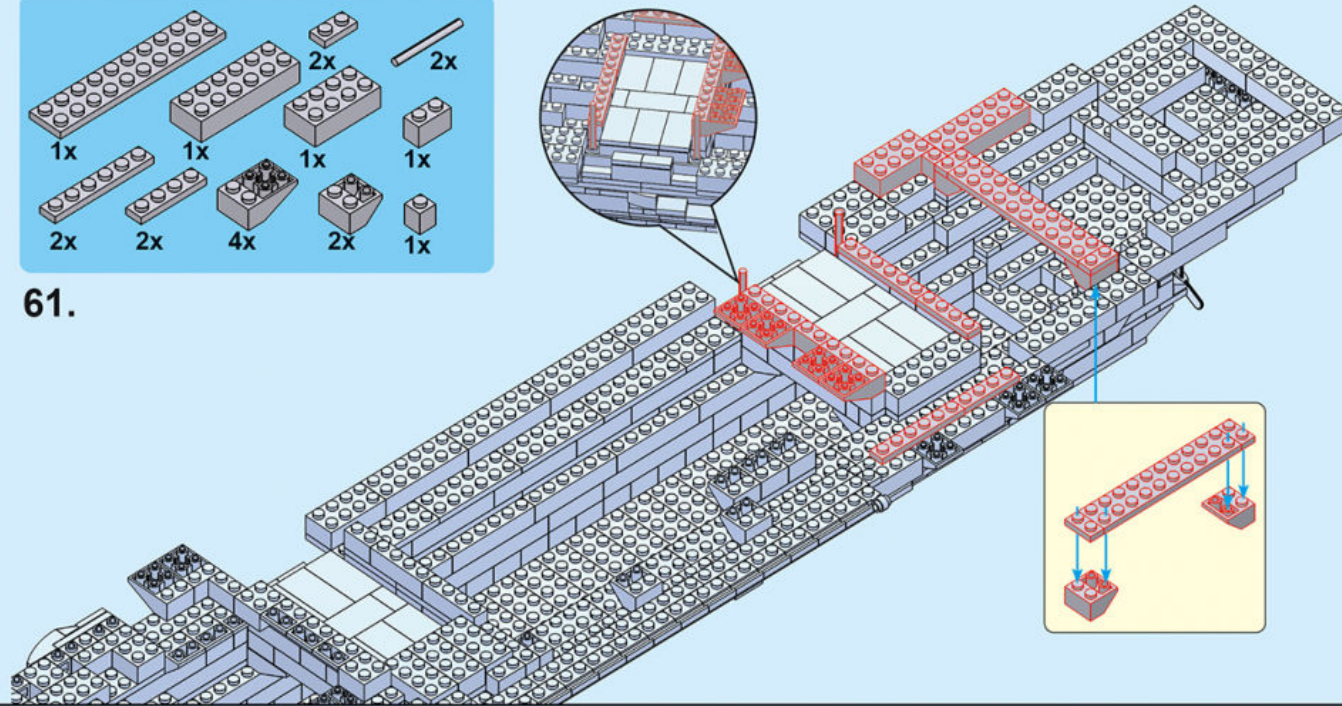

62.

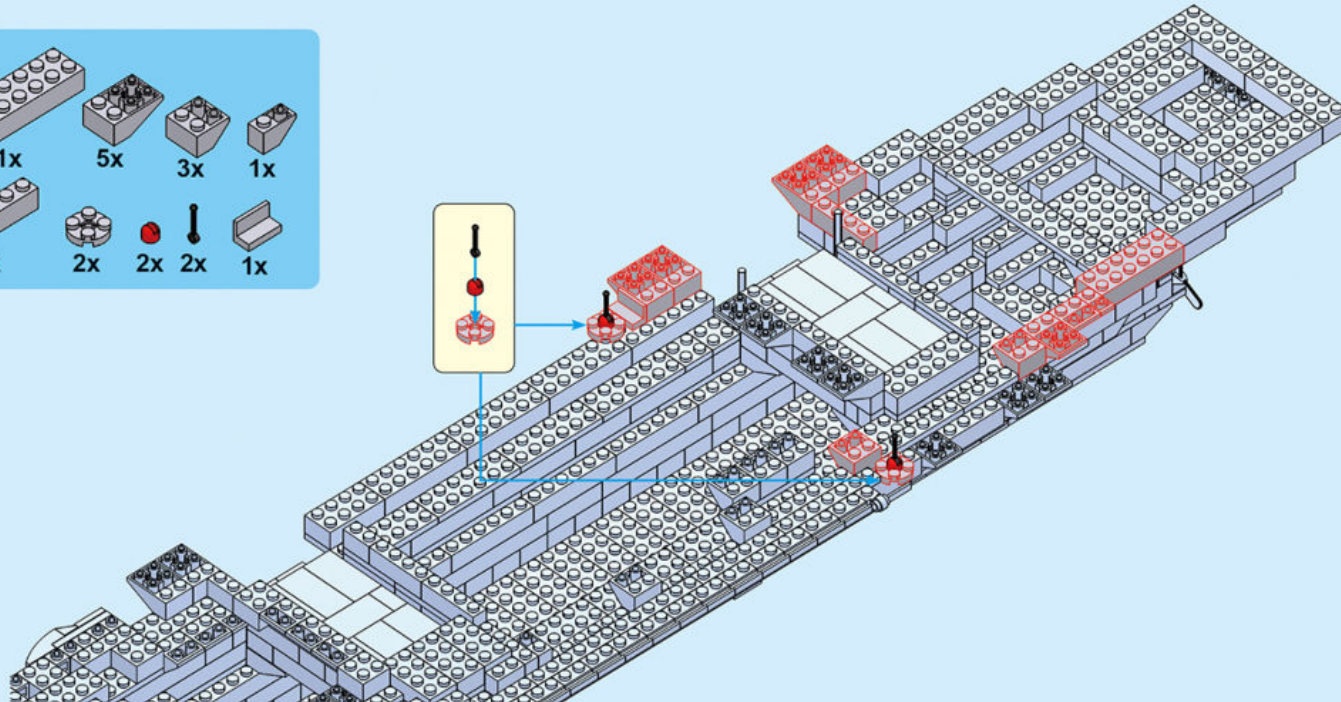

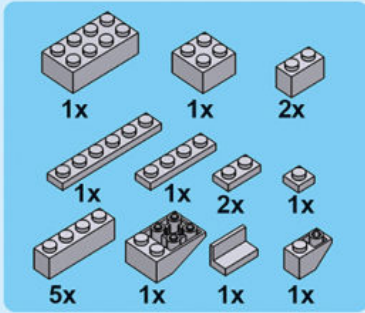

63.

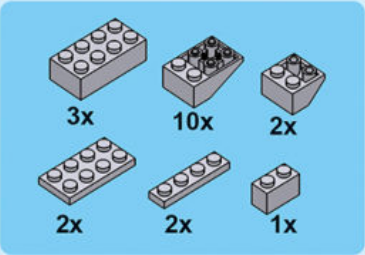
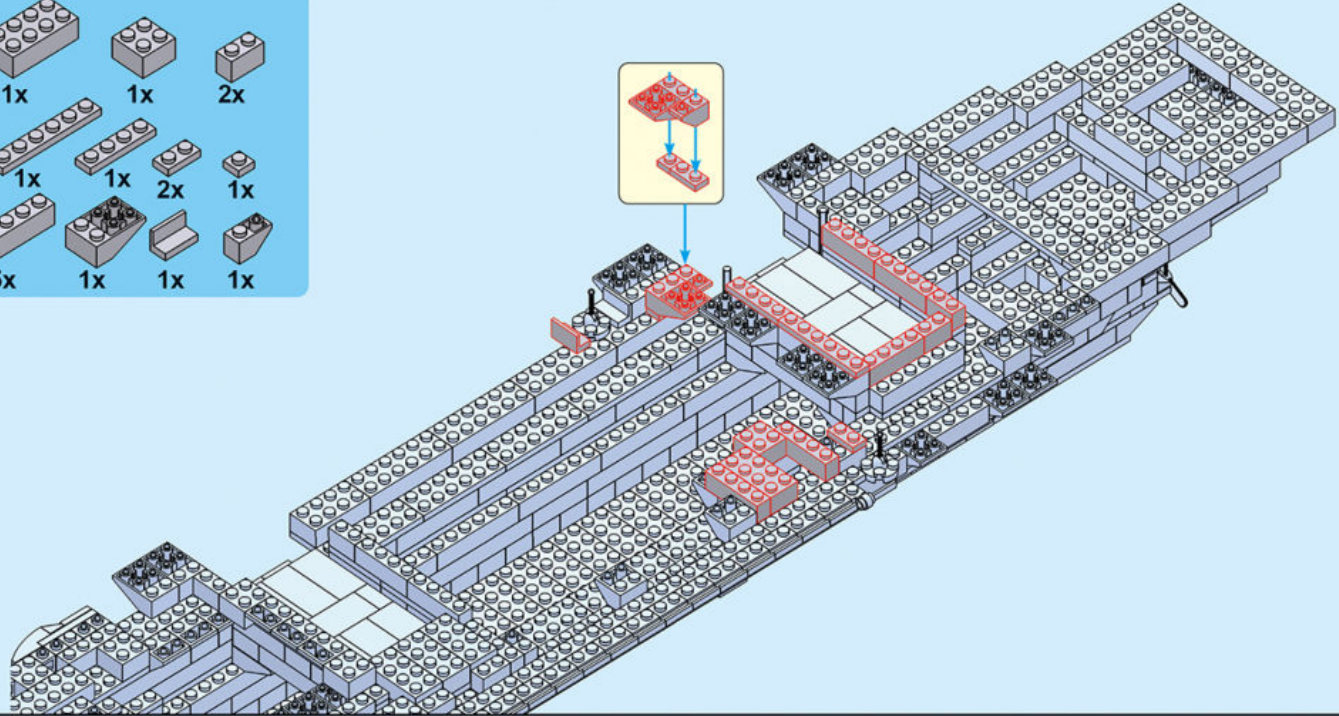

64.

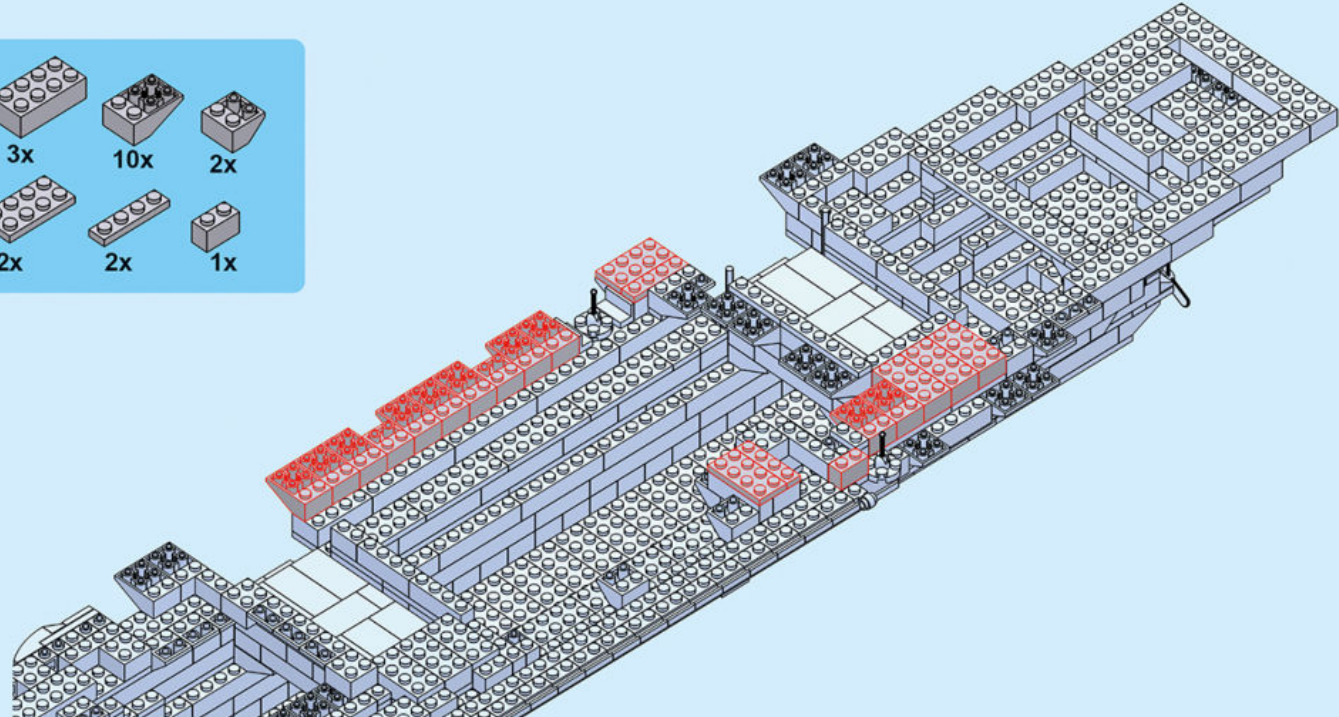

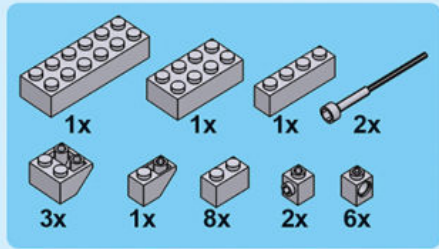

65.

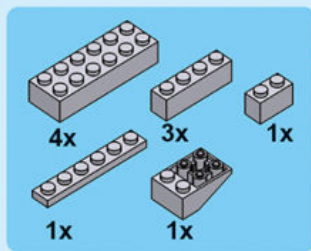
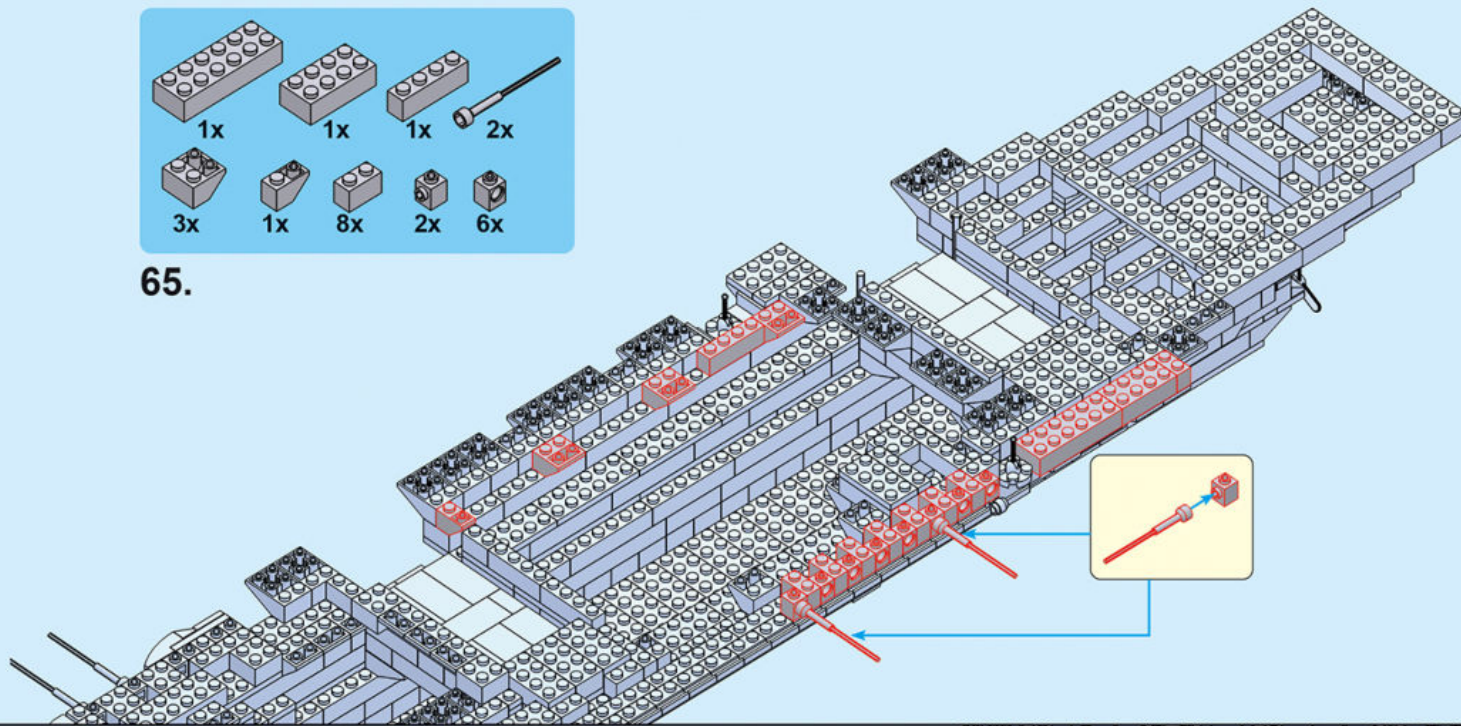

66.

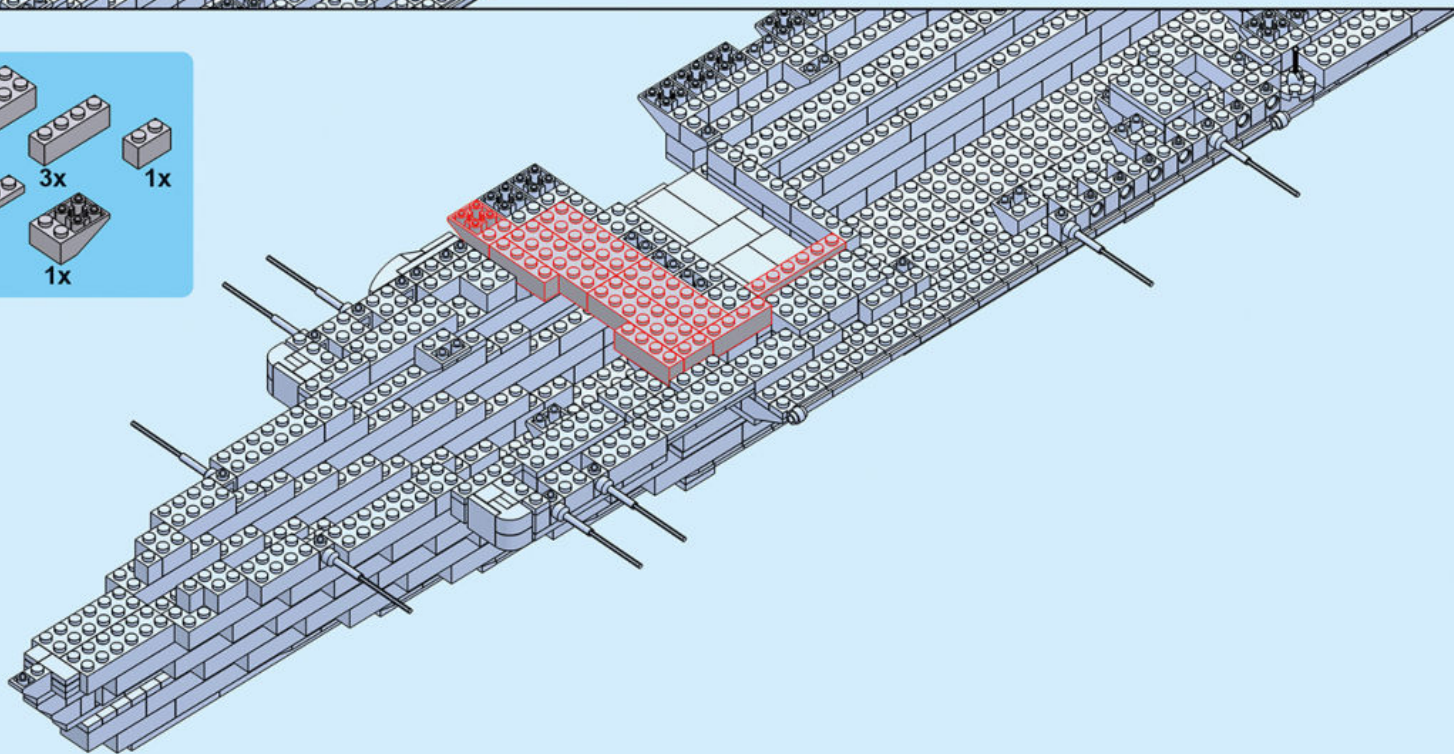

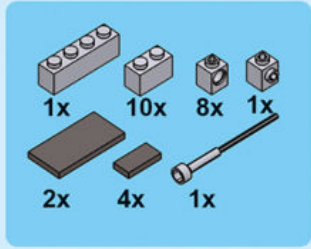

67.

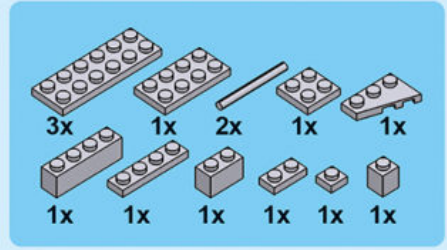
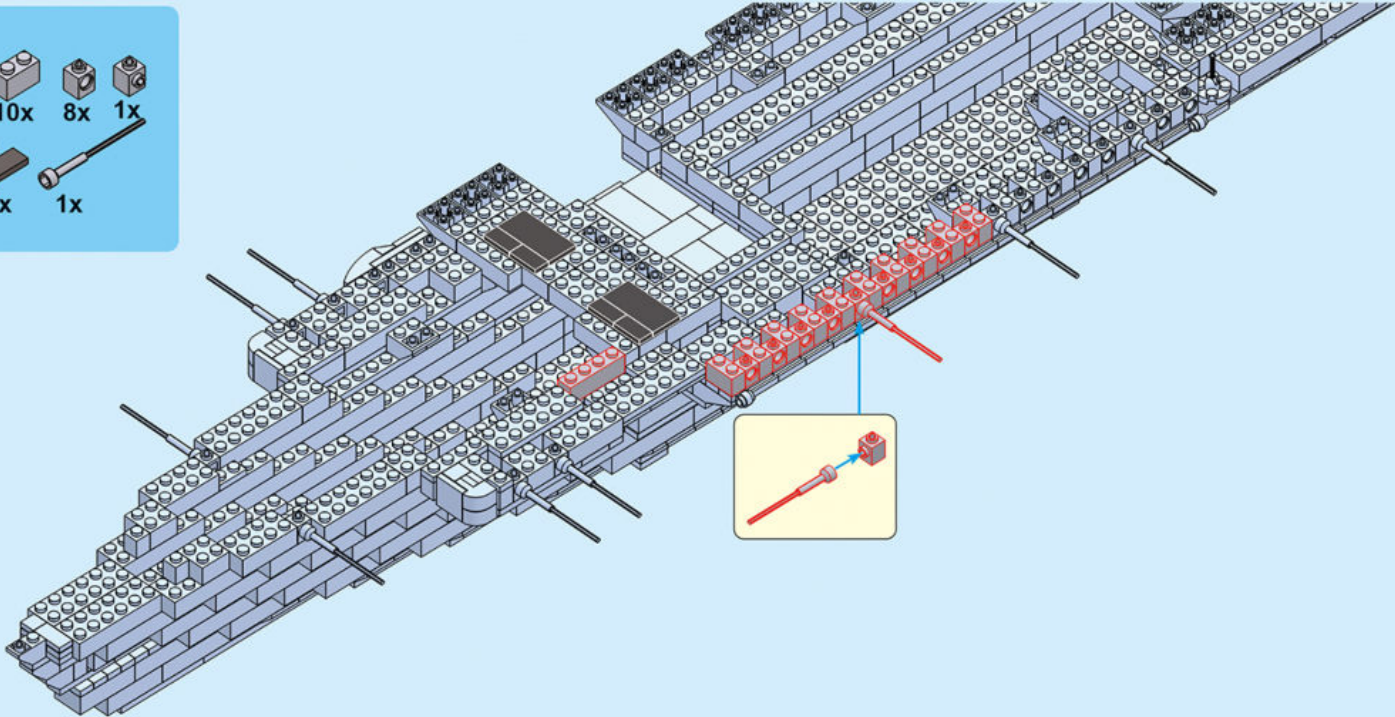

68.

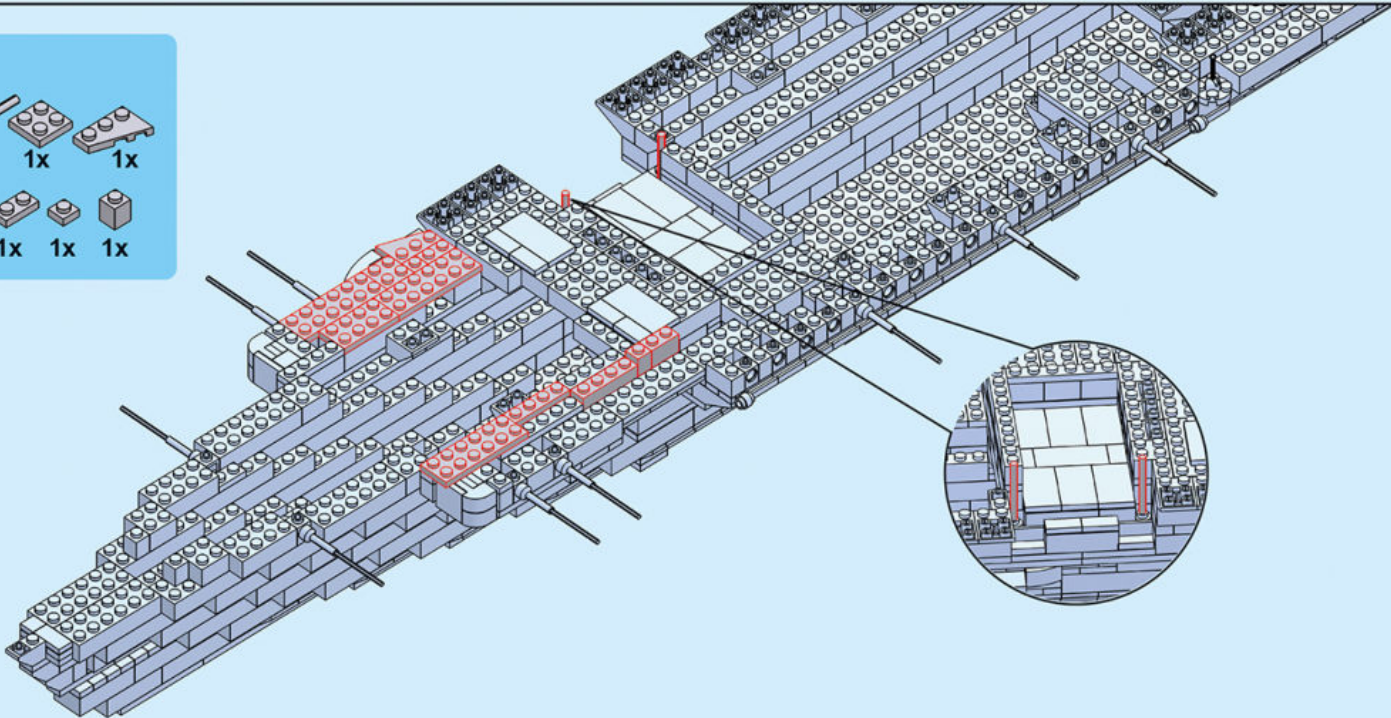



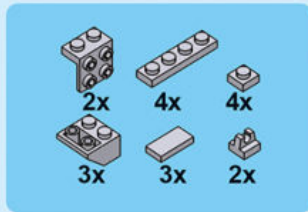

69.

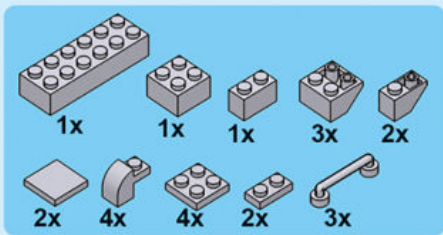
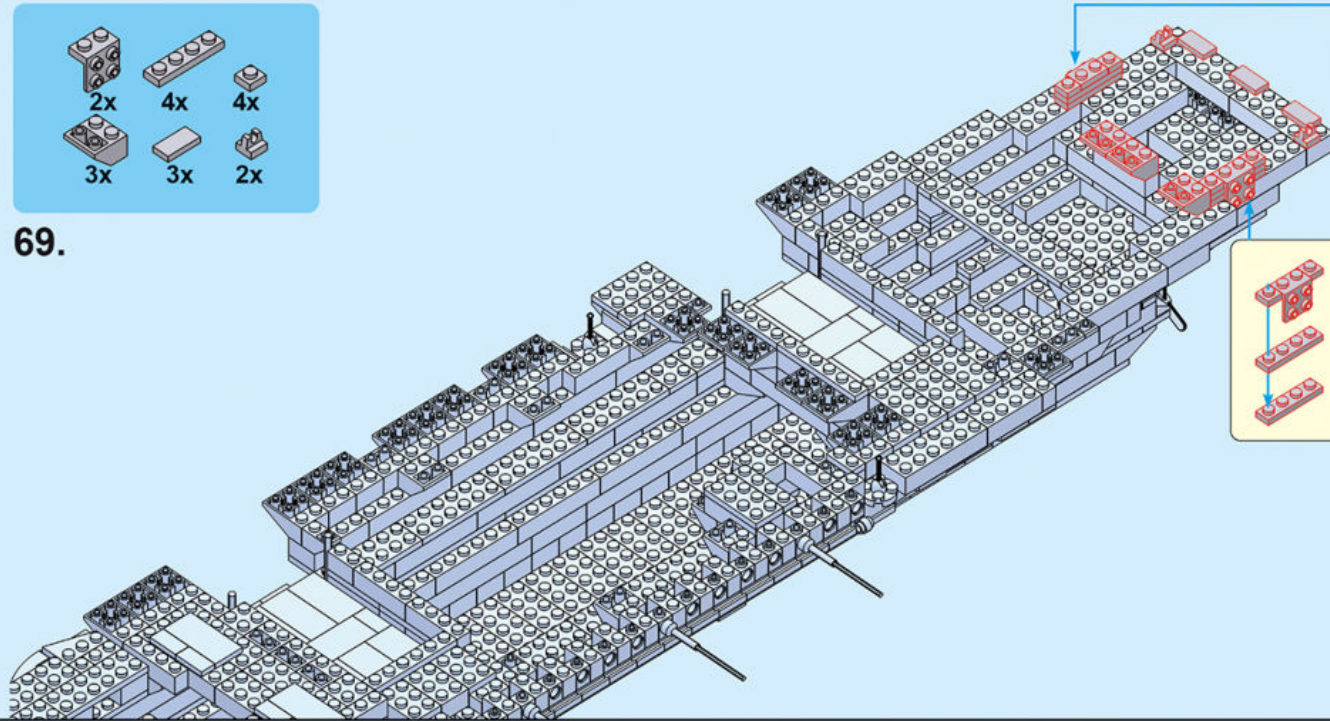

70.

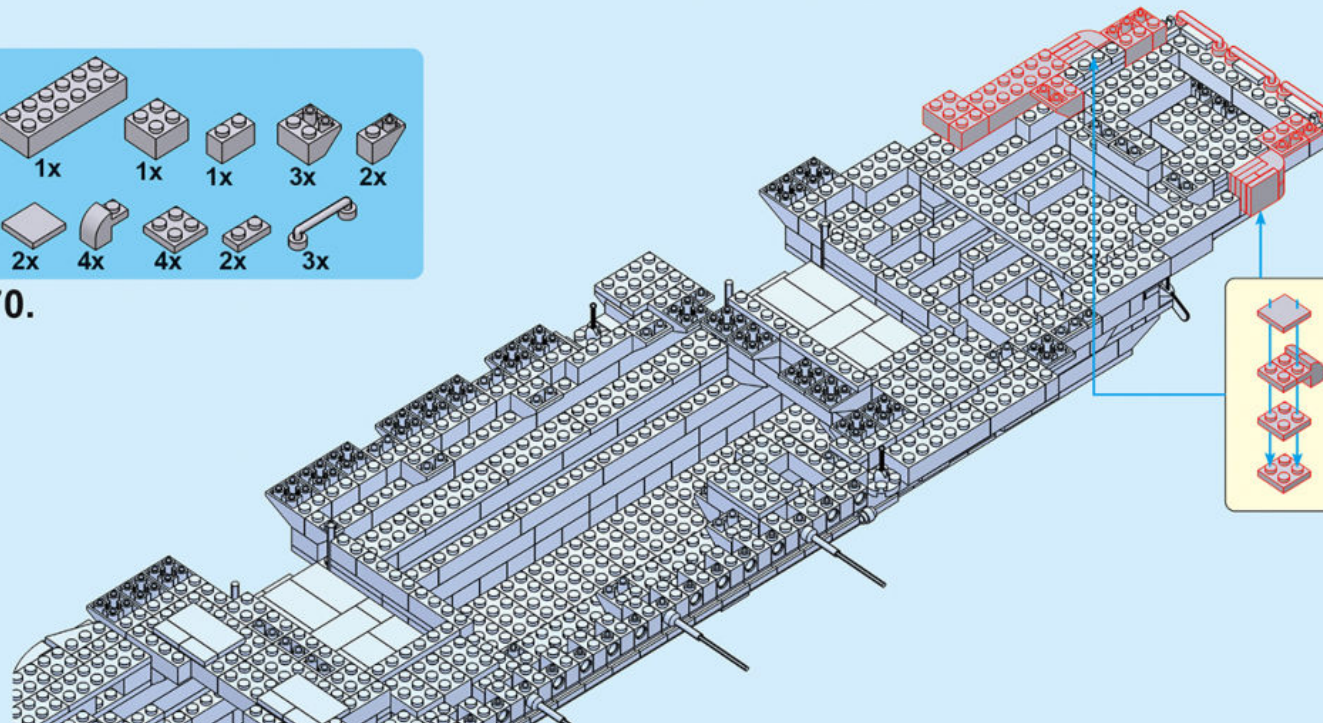

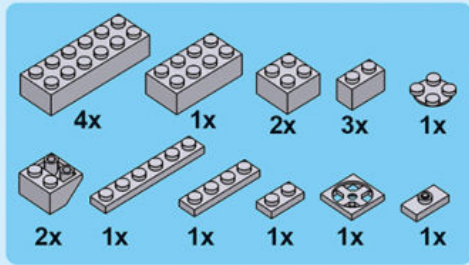

71.

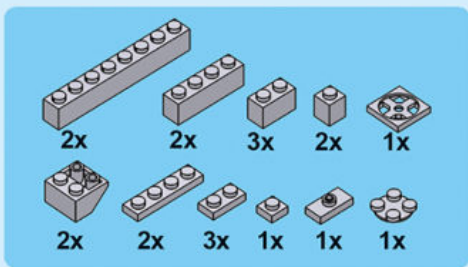
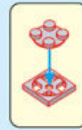
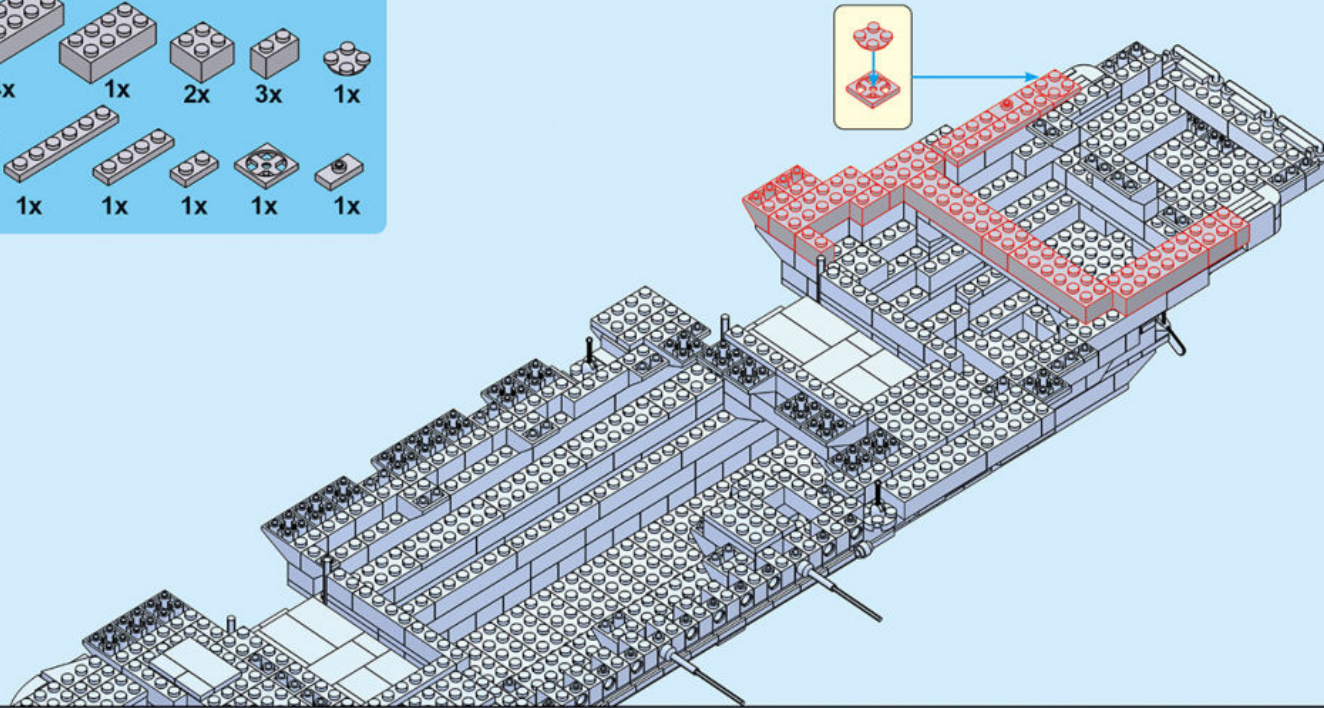

72.

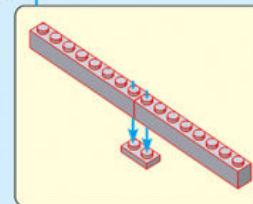
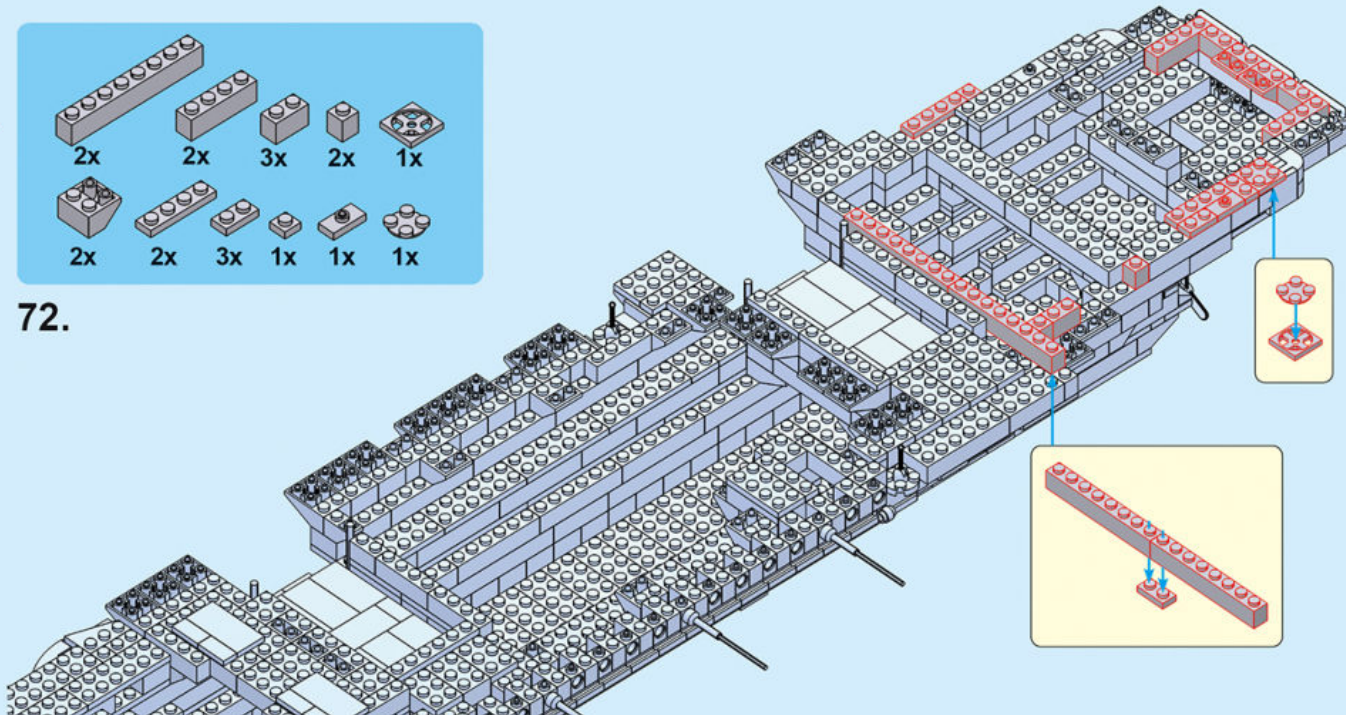

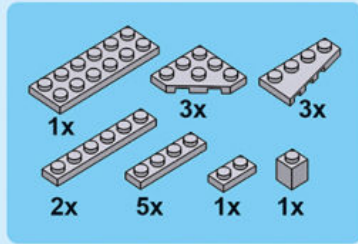

73.

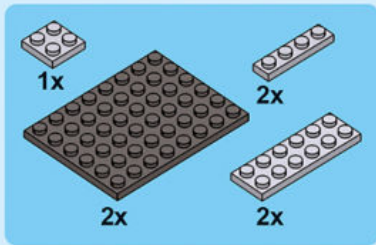
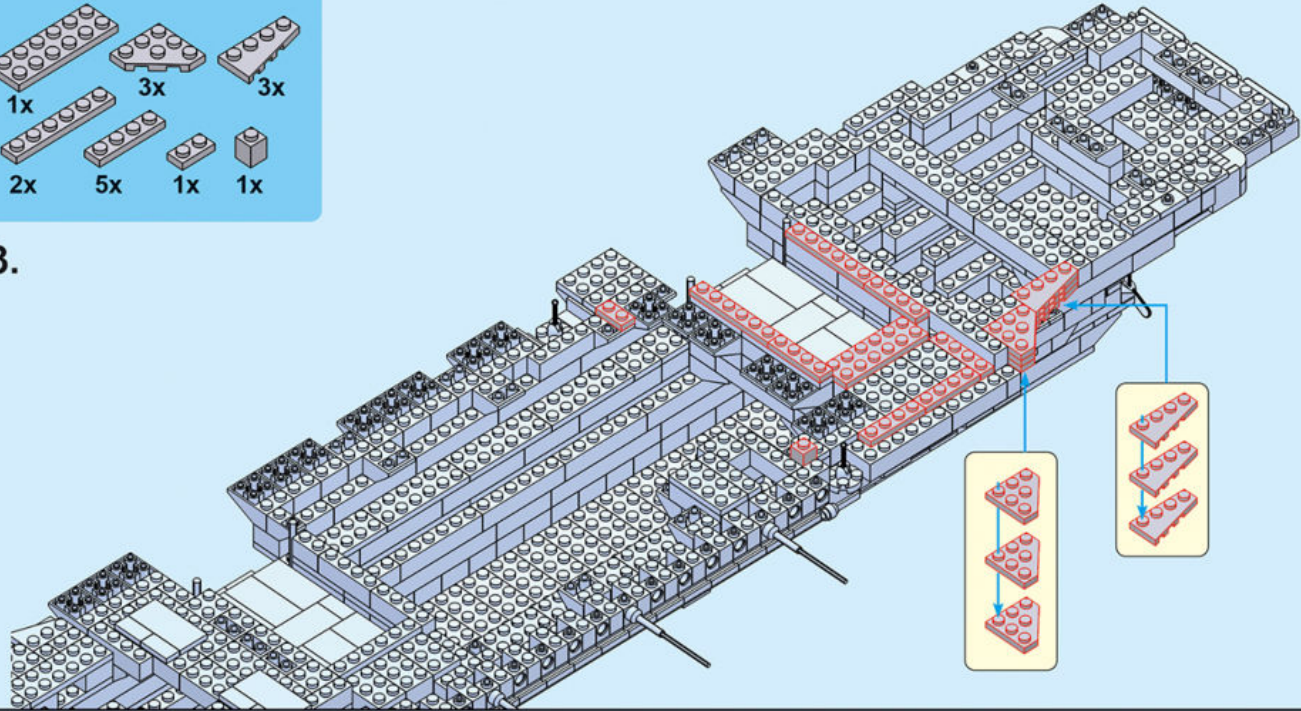

74.

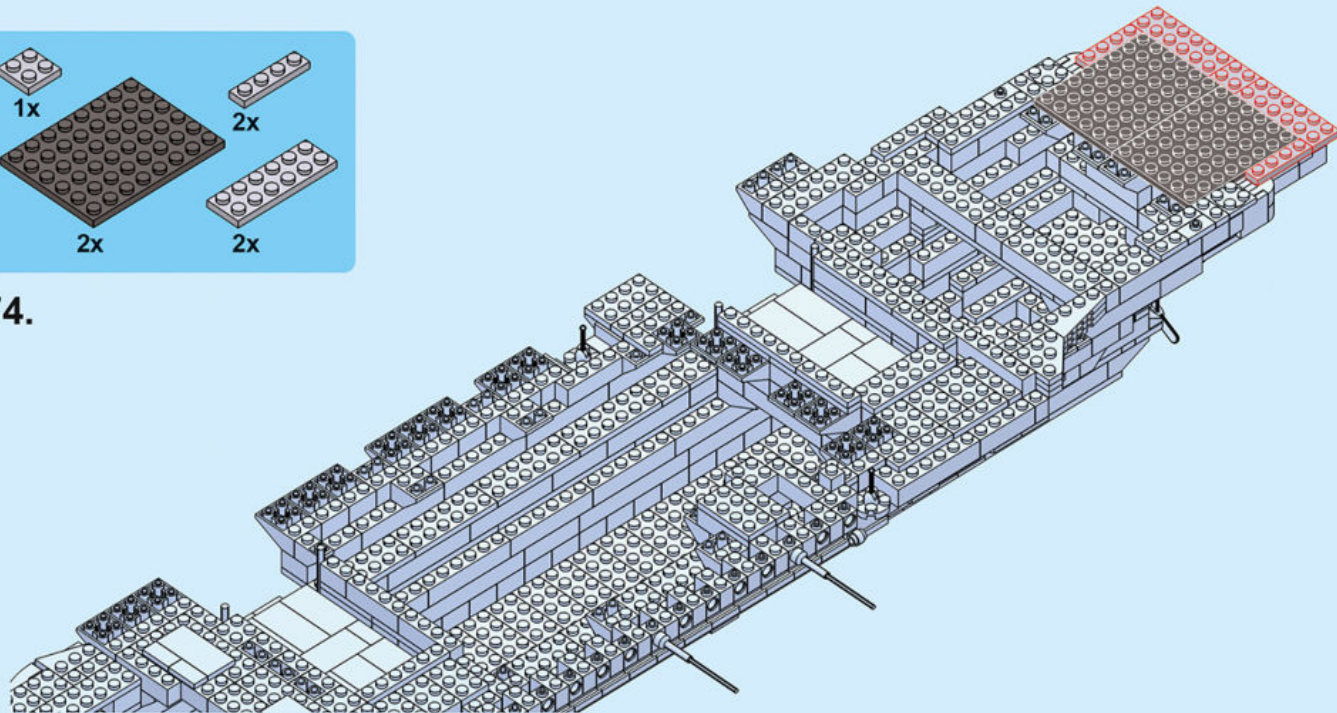

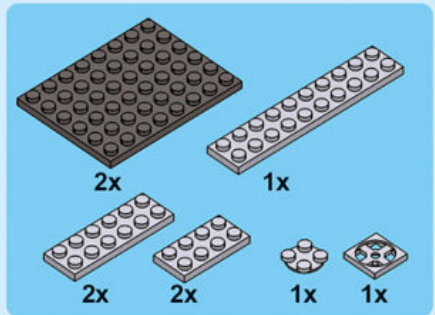

75.

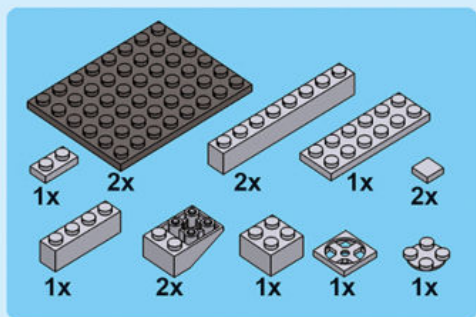
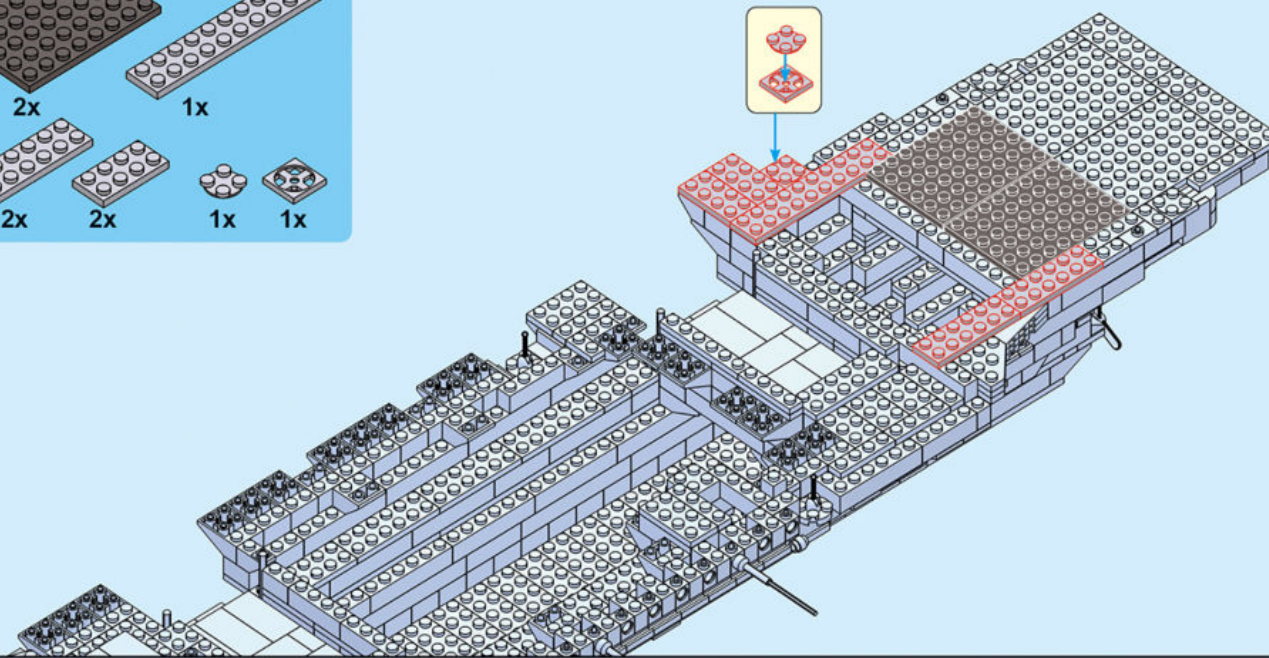

76.

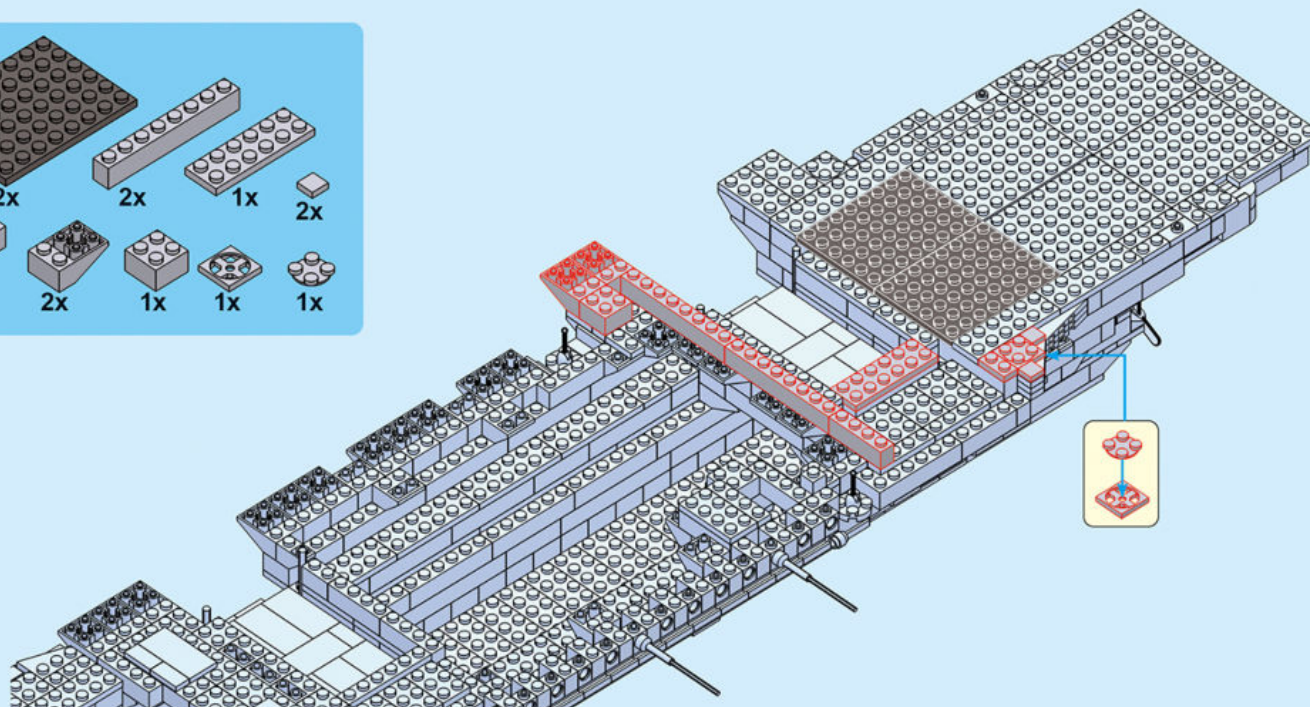

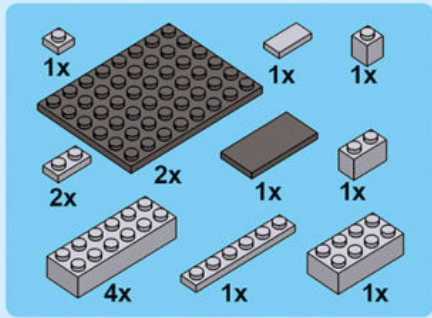

77.

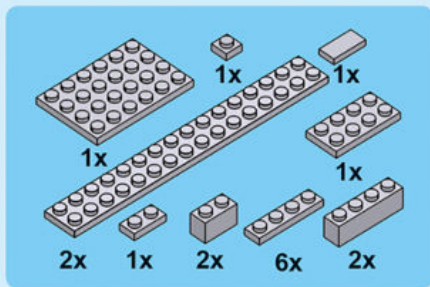
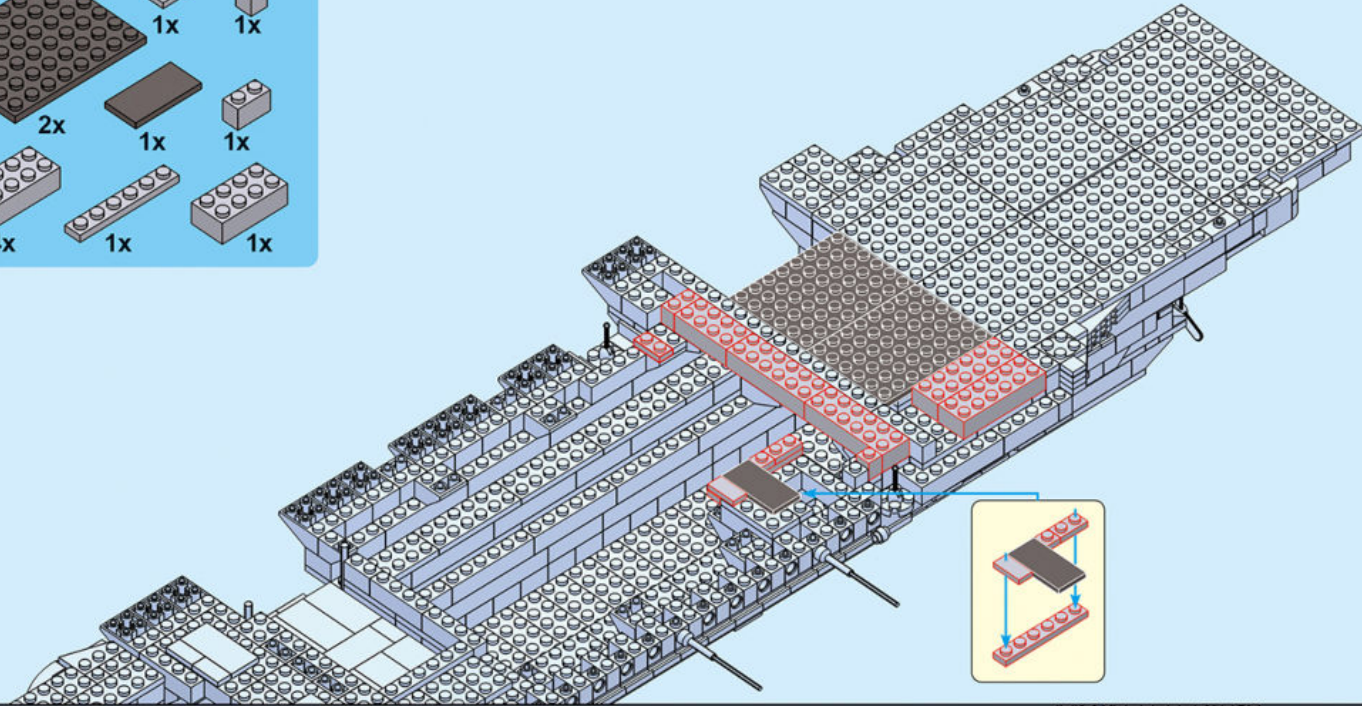

78.

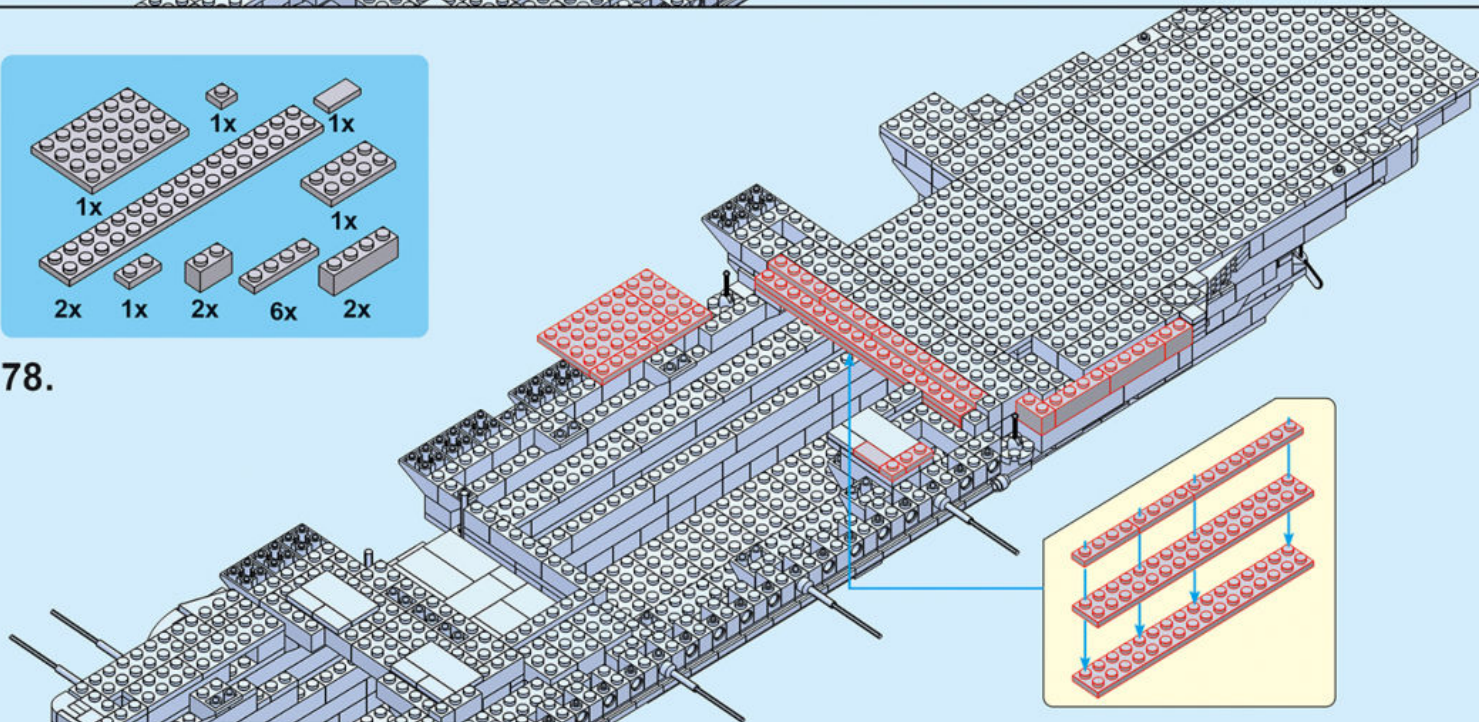

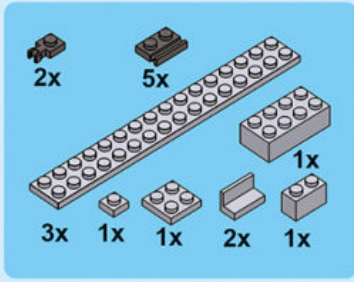

79.

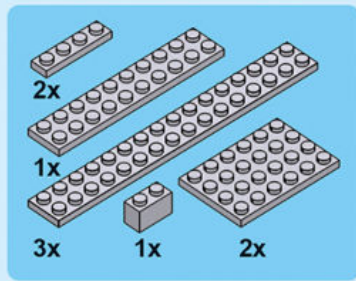
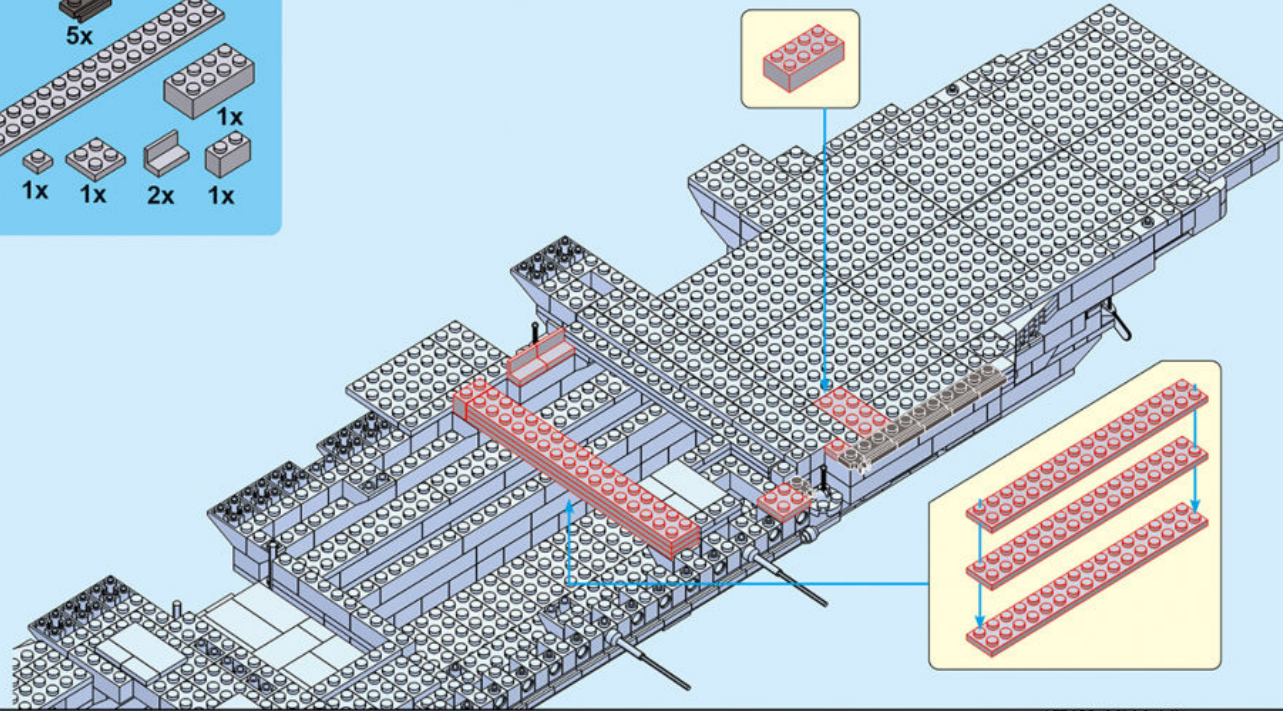

80.

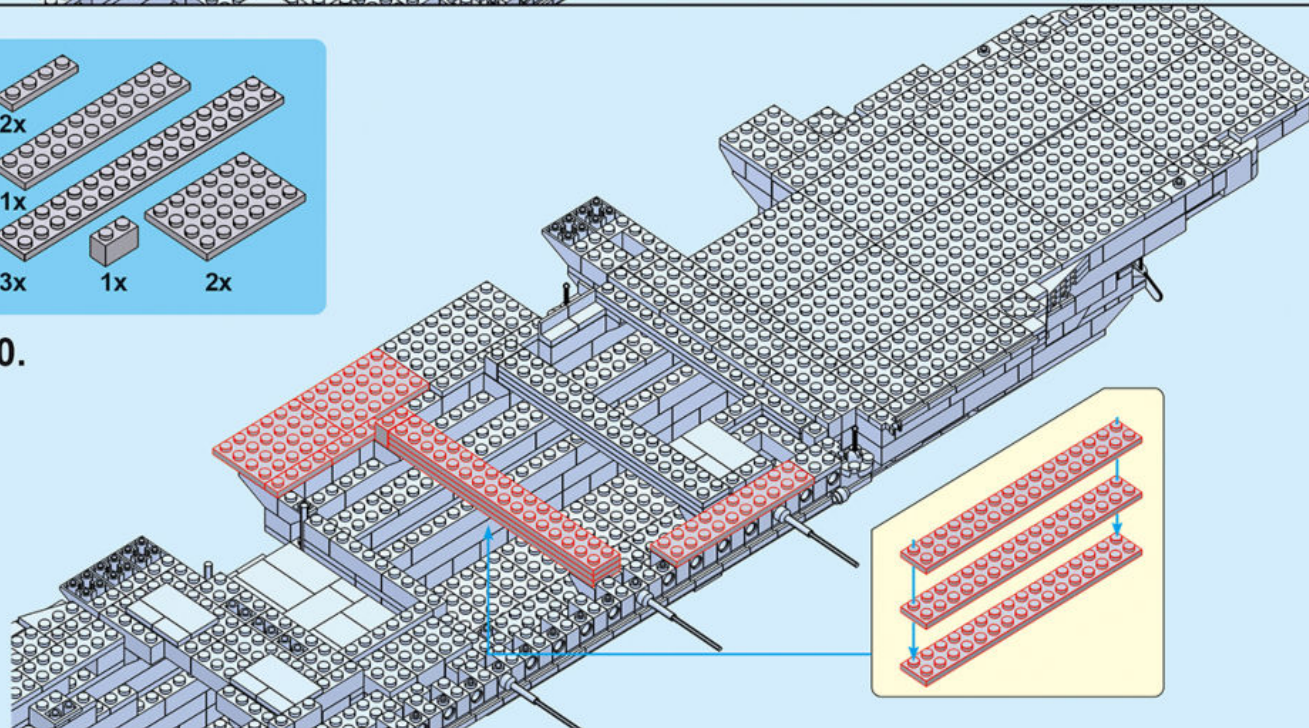

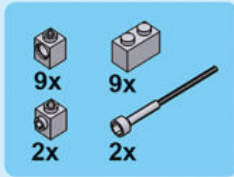

81.

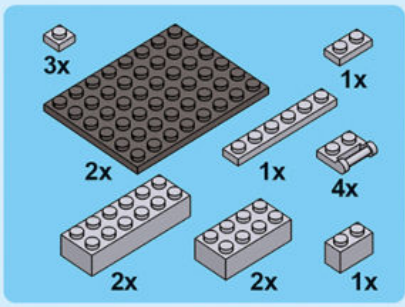
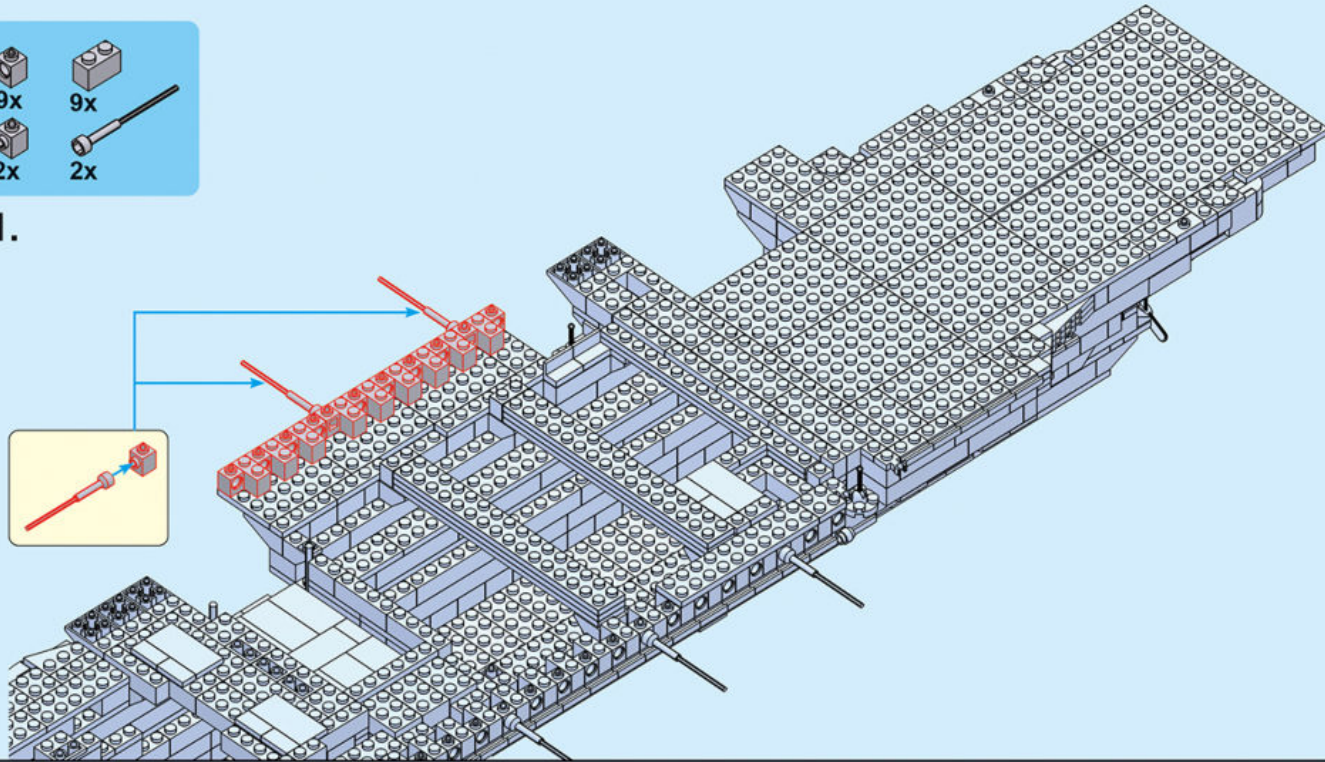

82.

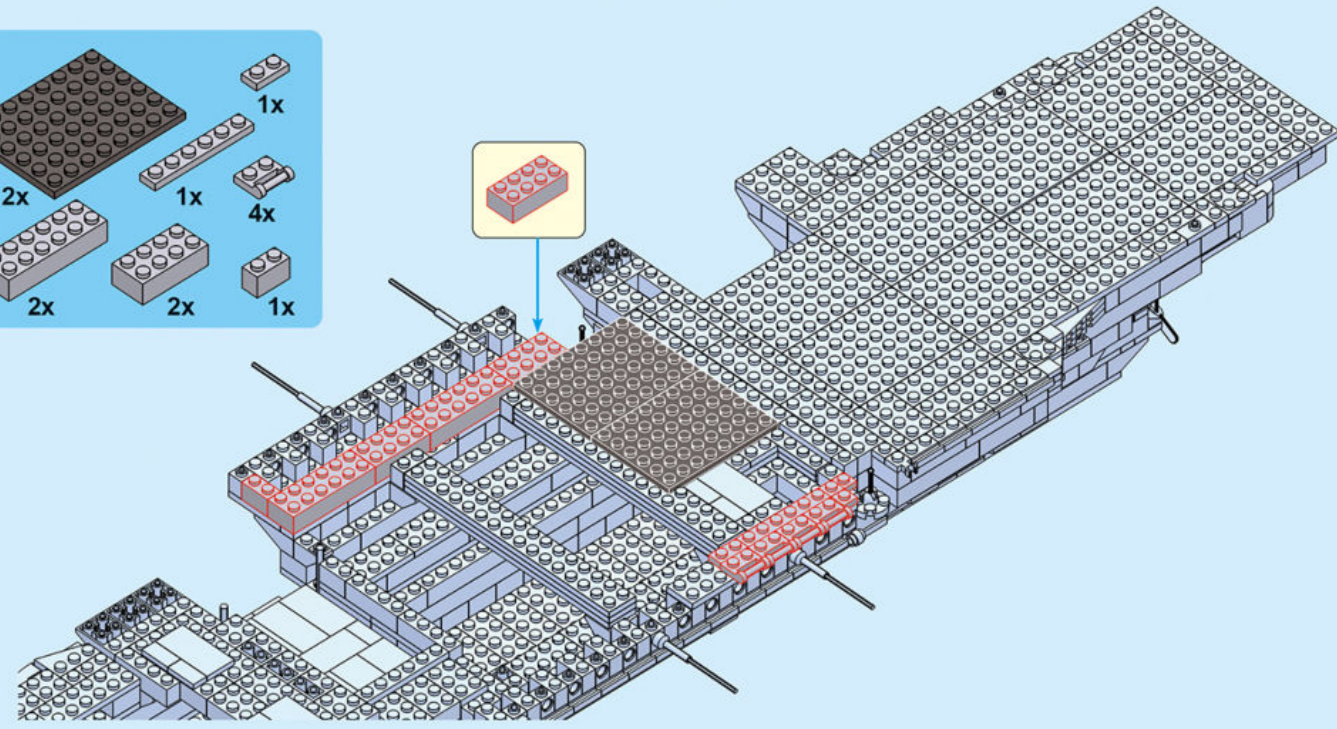

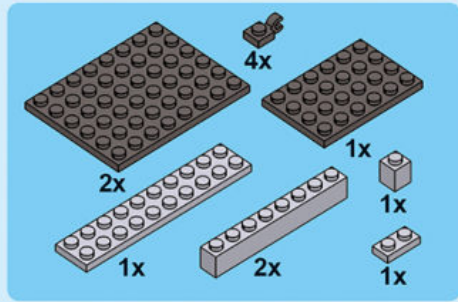

83.

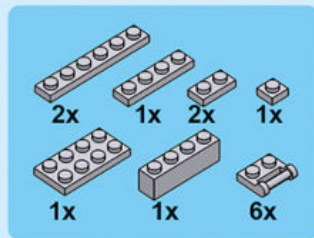
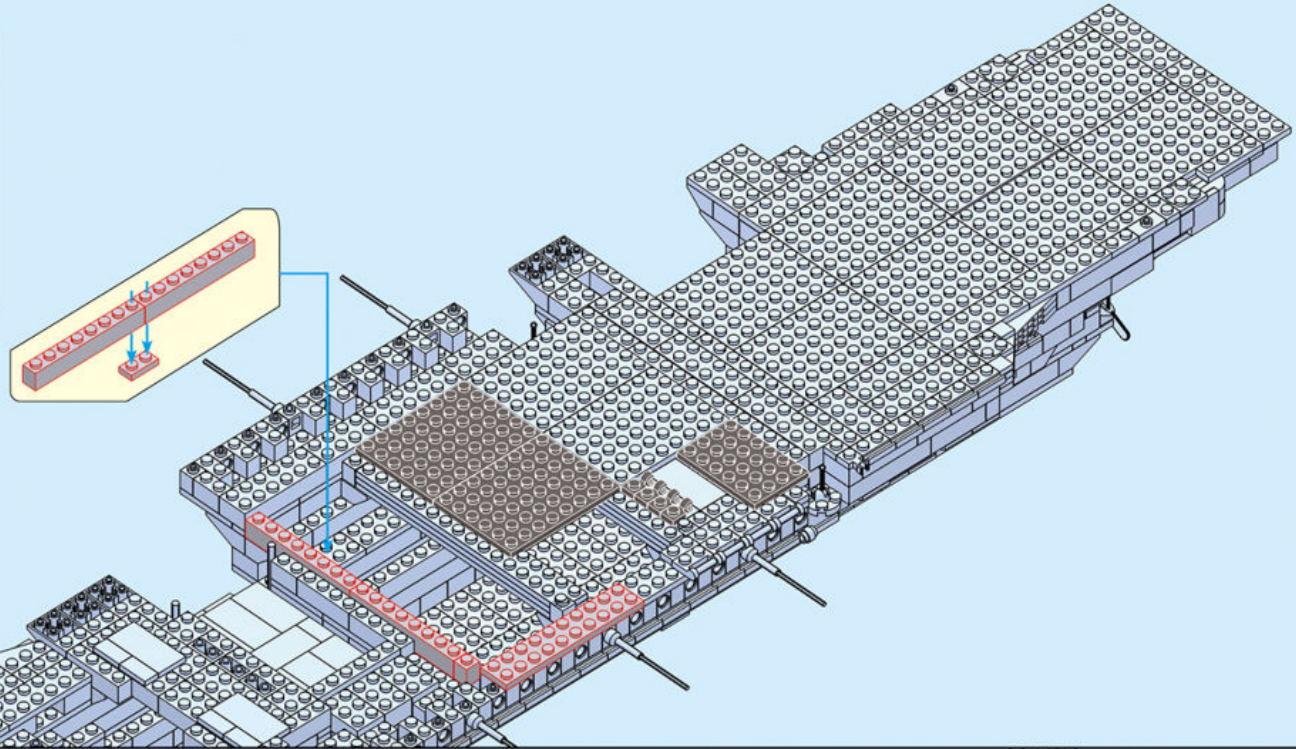

84.

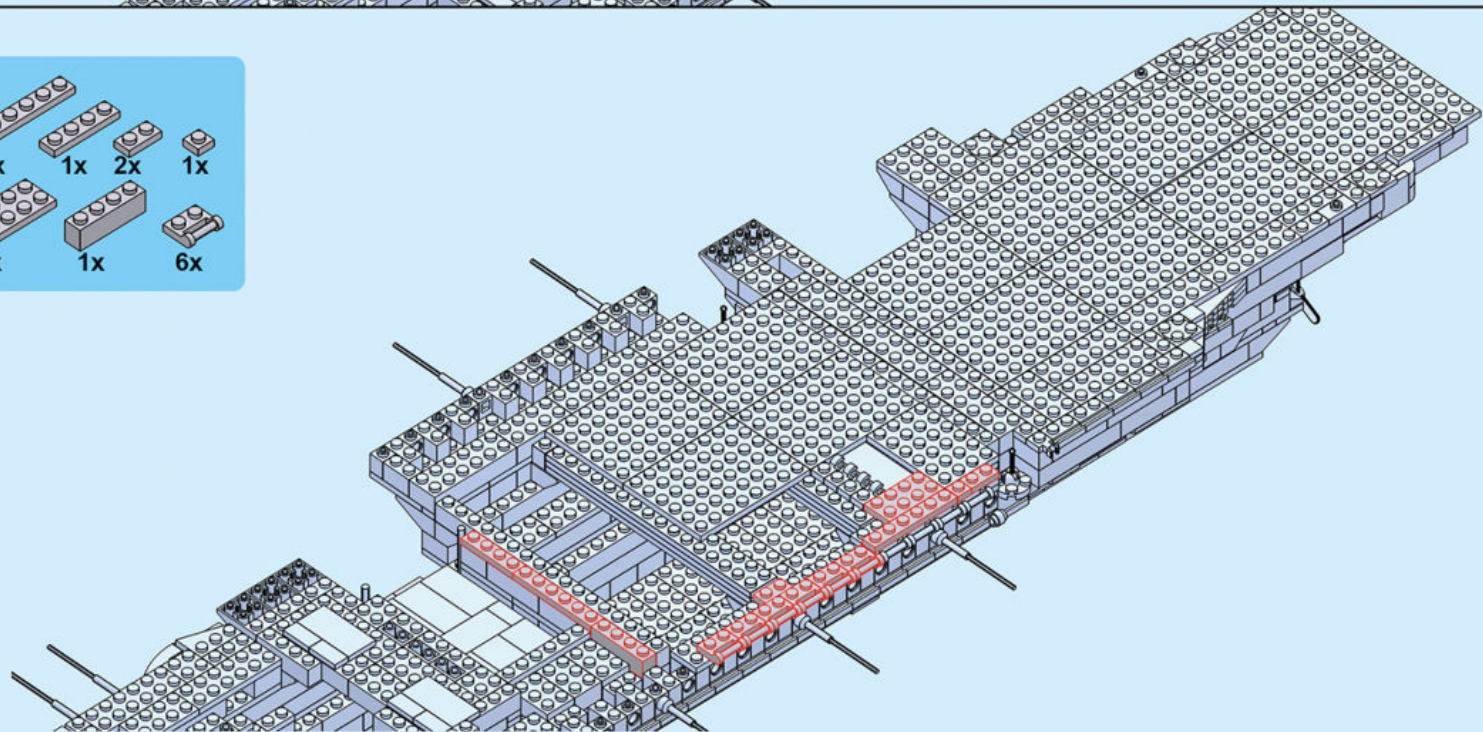



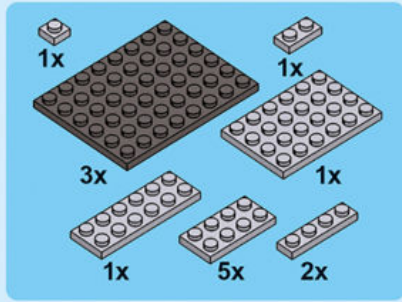

85.

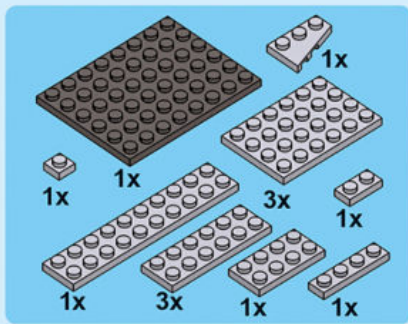
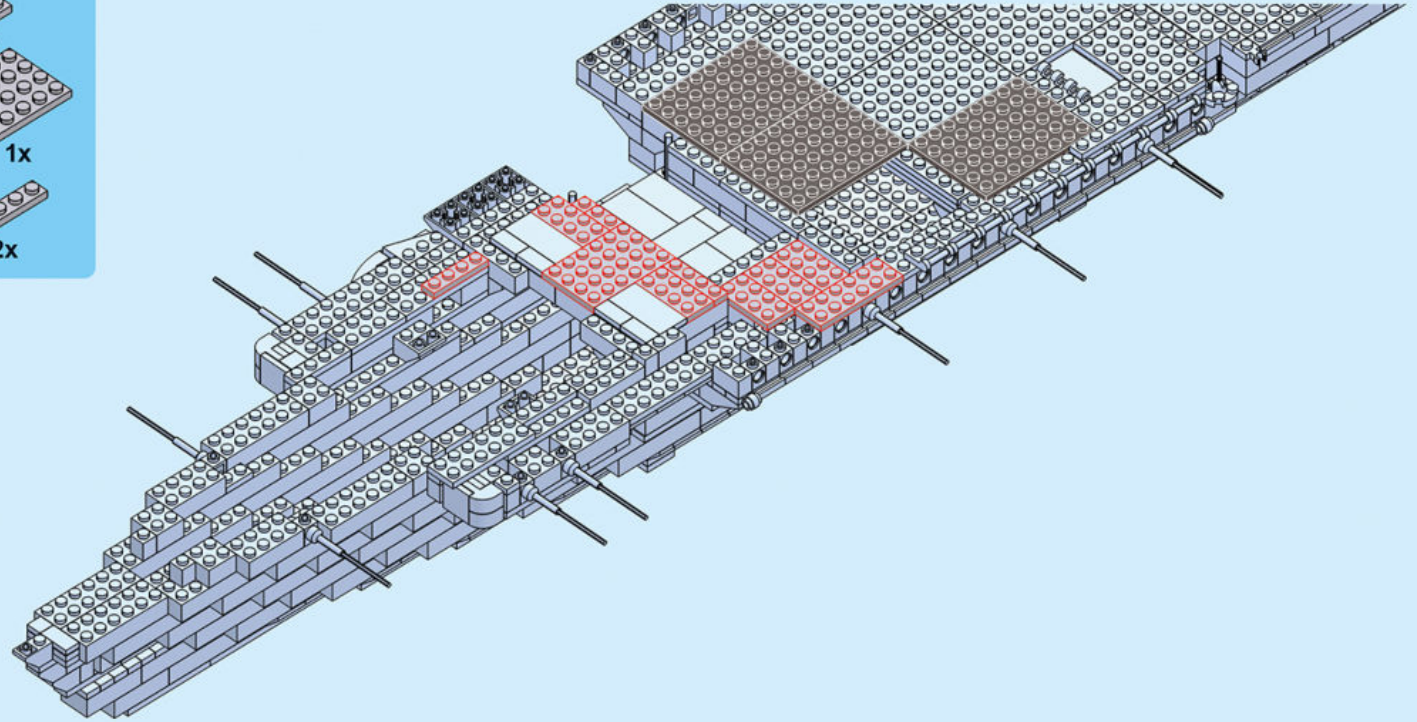

86.

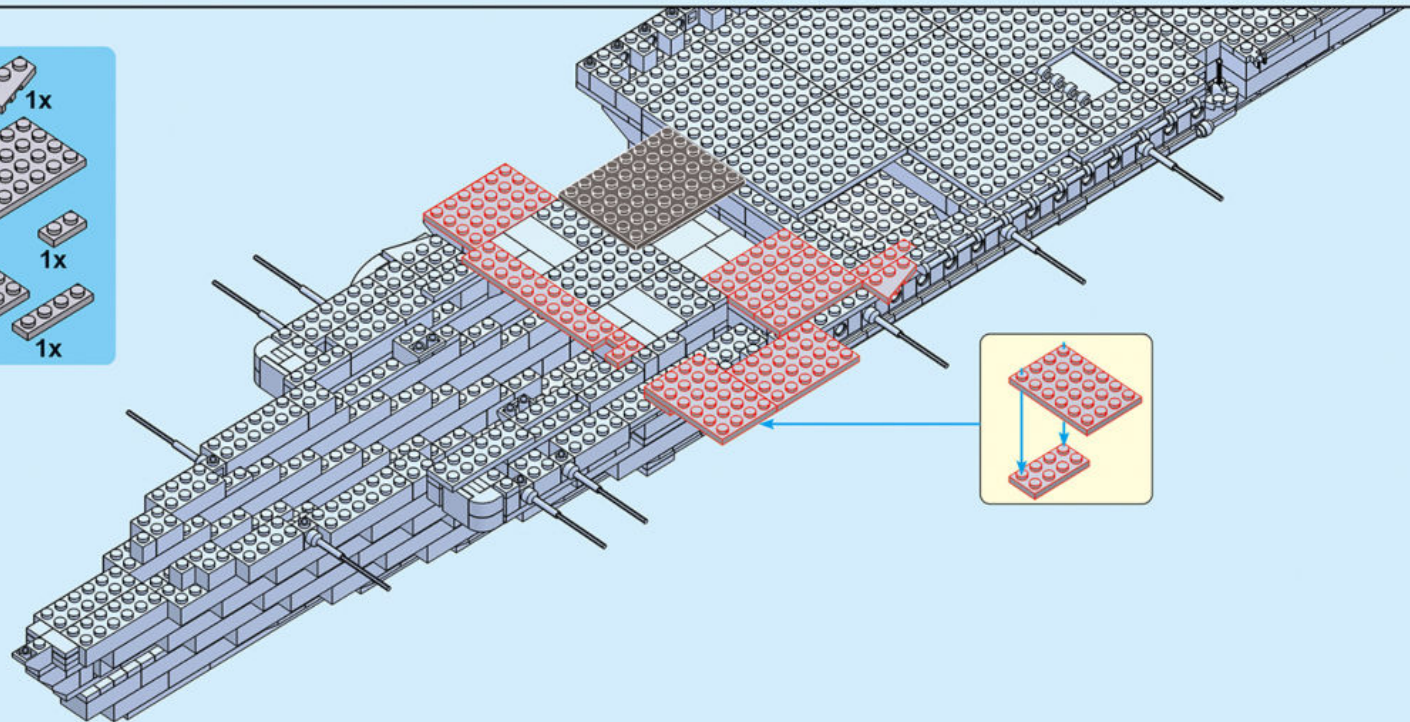

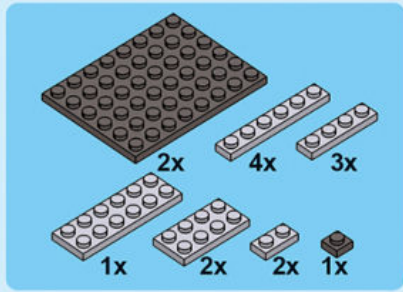

87.

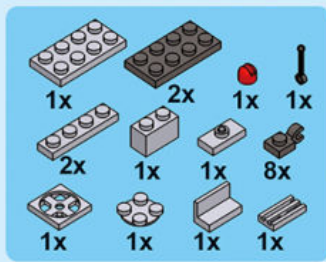
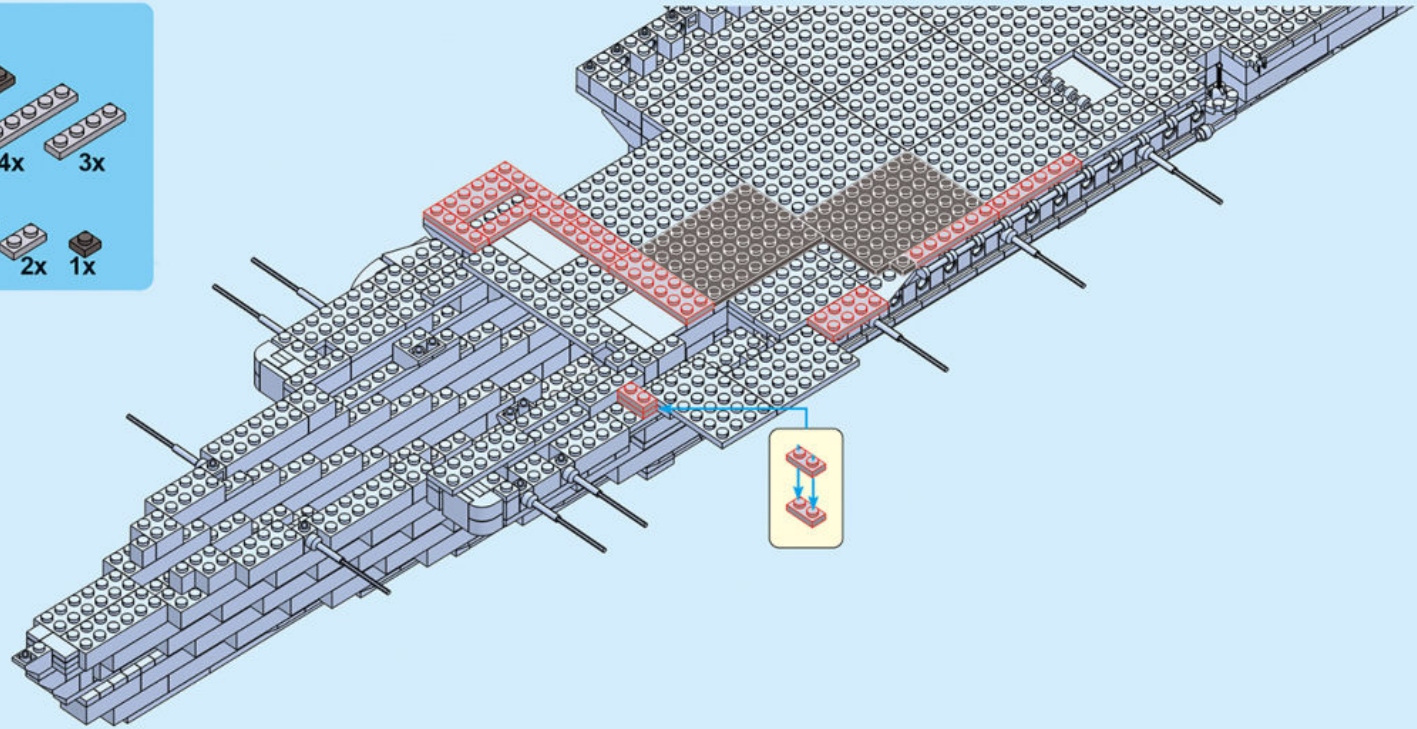

88.

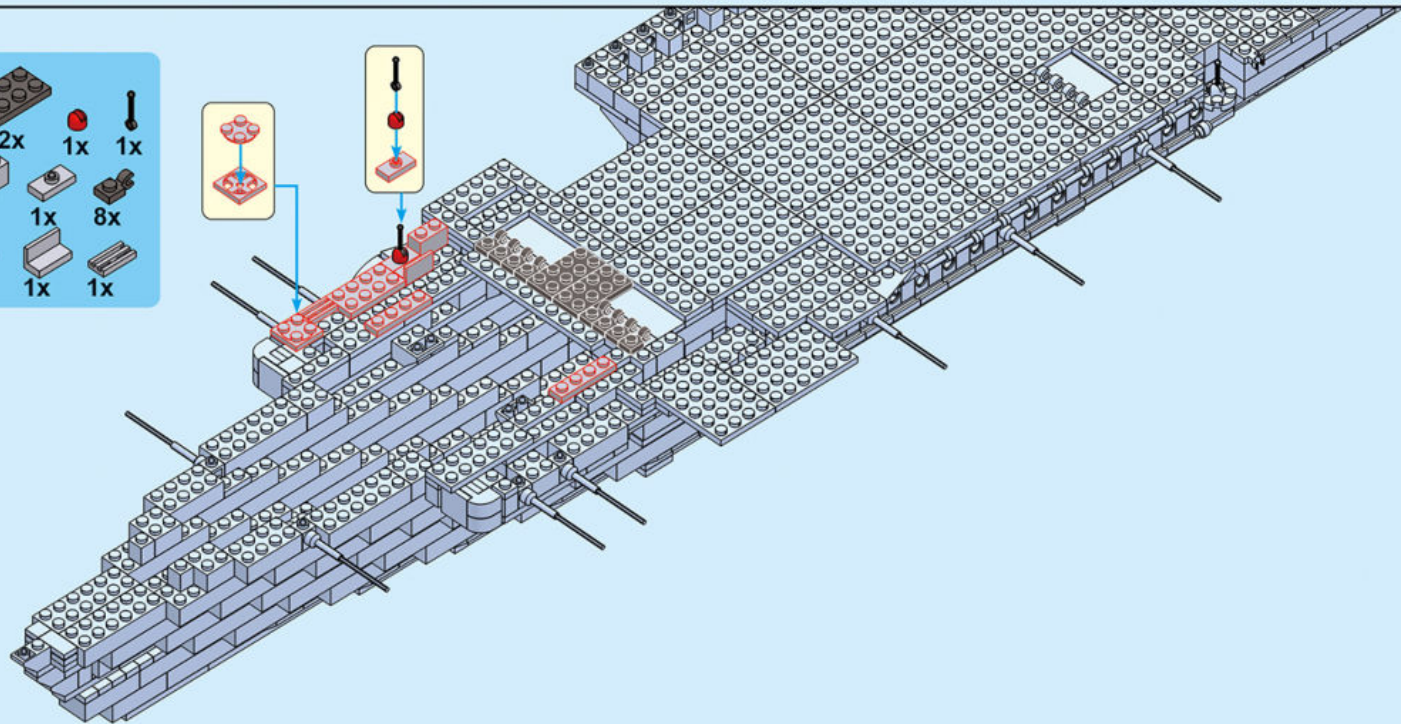

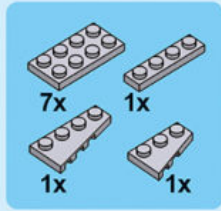

89.

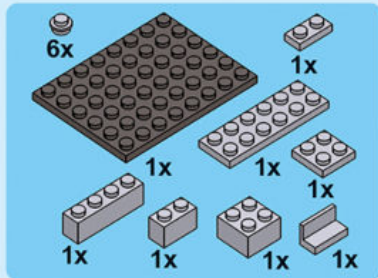
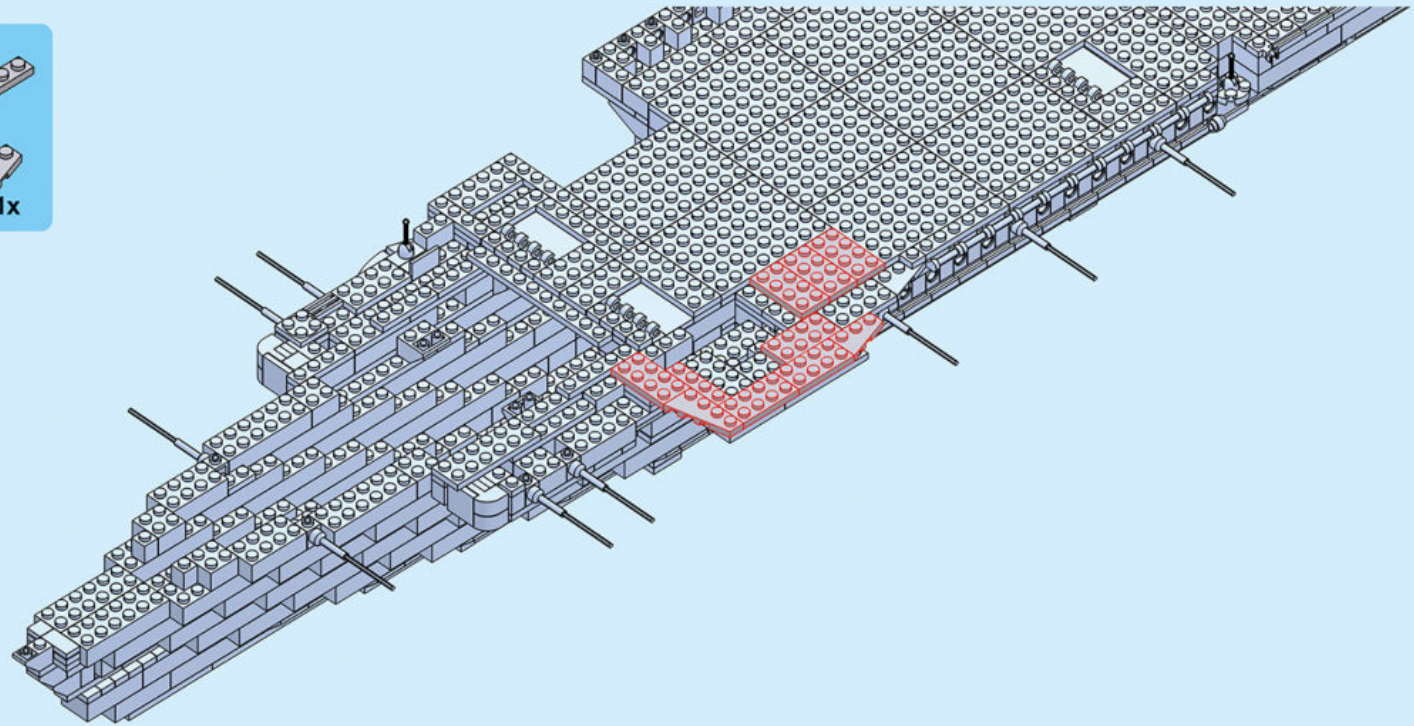

90.

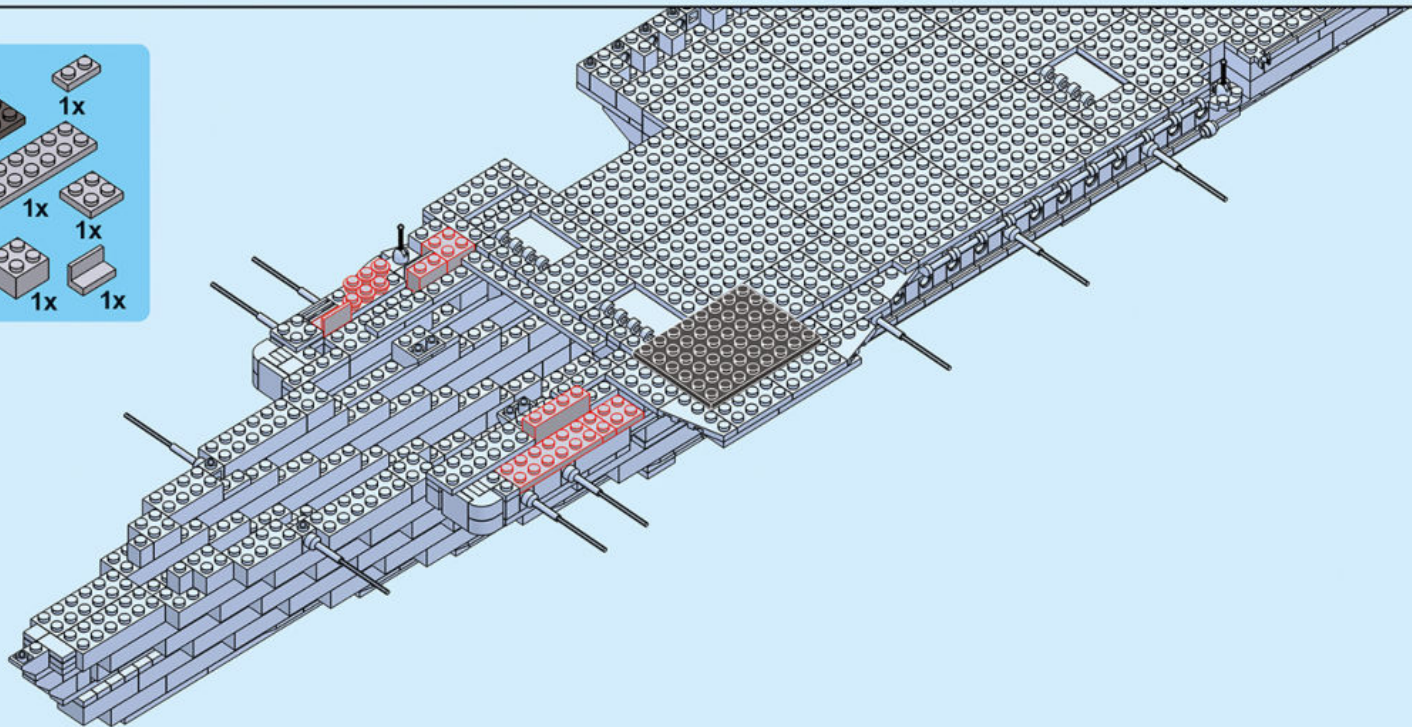

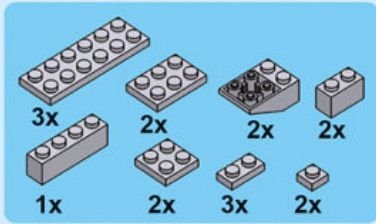

91.

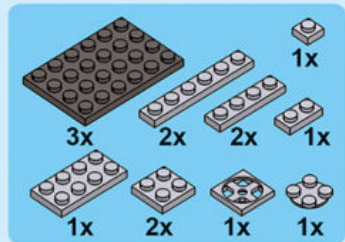
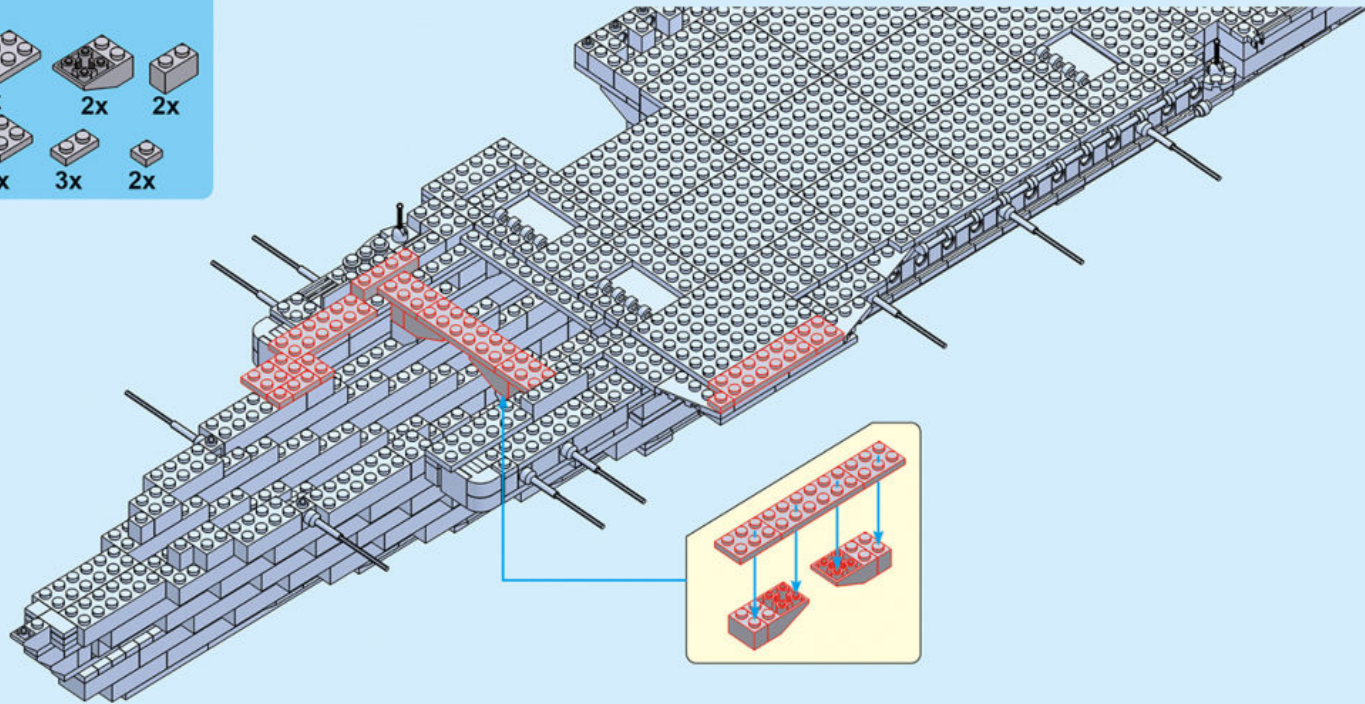

92.

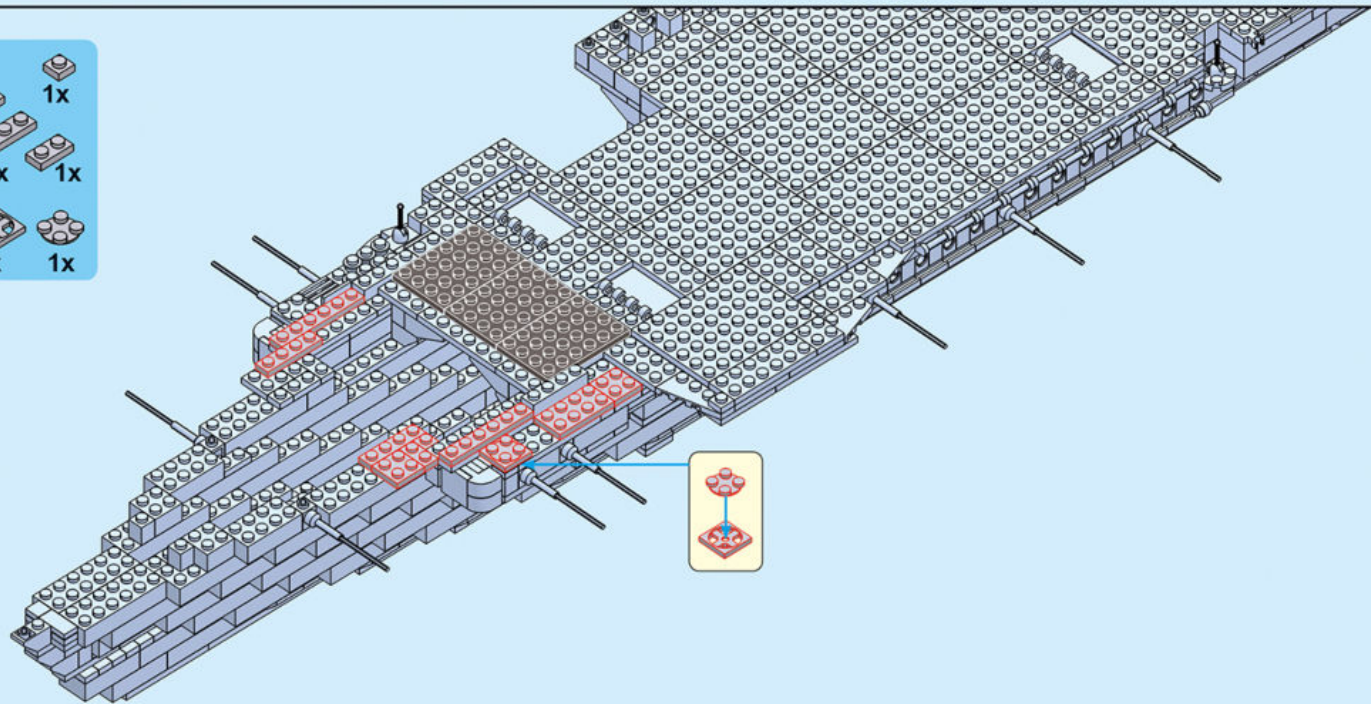

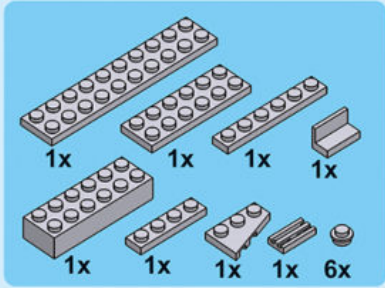

93.

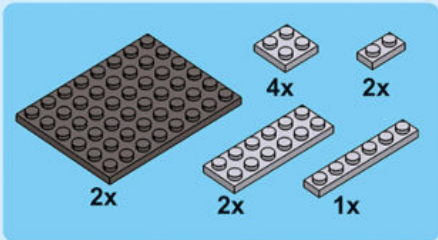
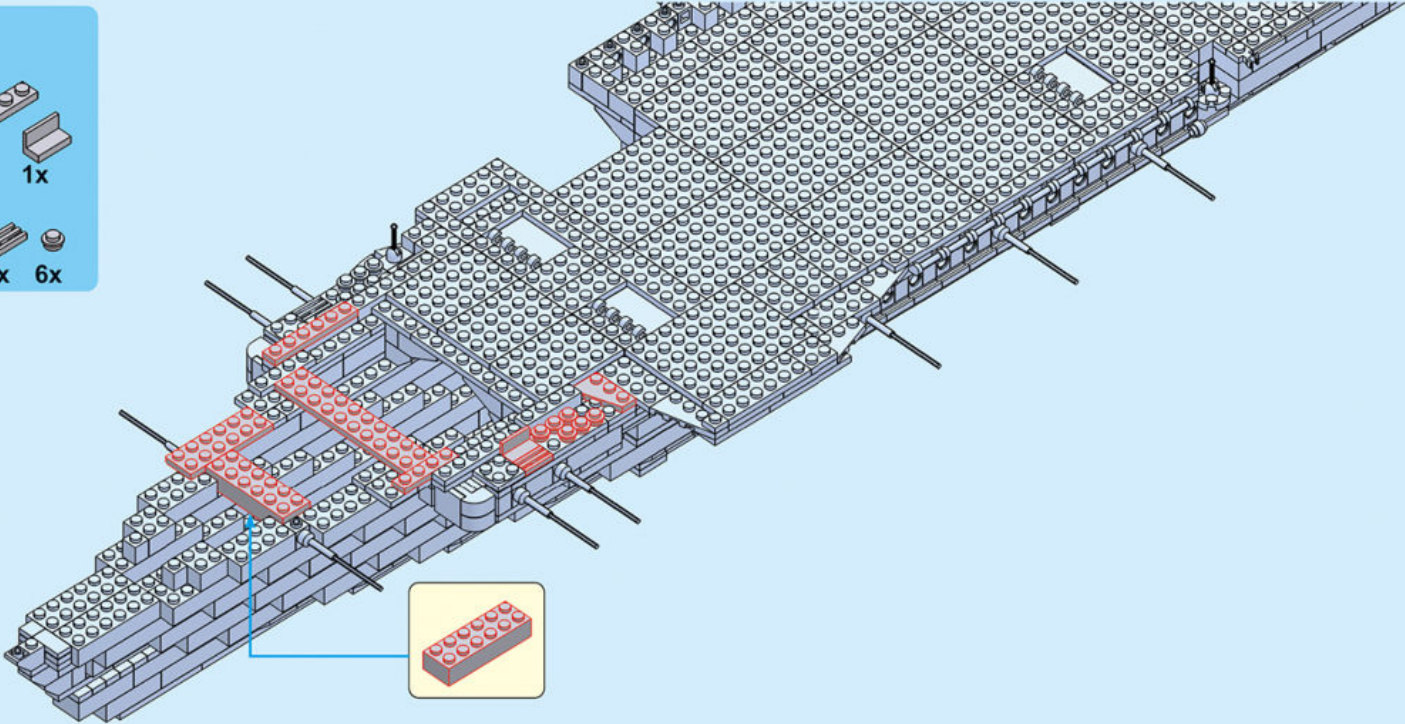

94.

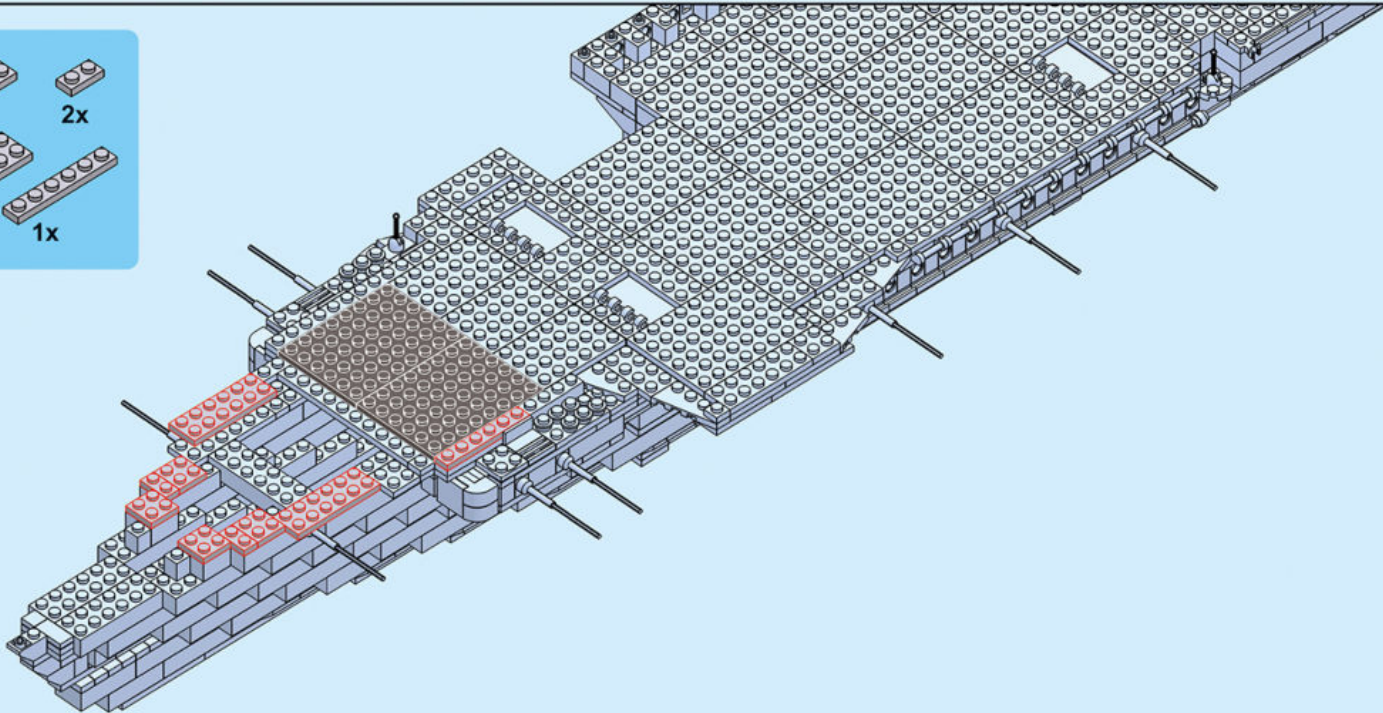

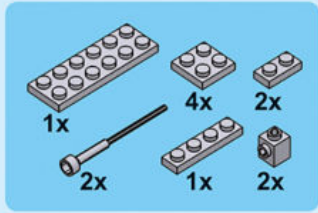

95.

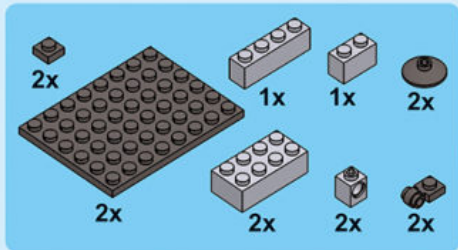
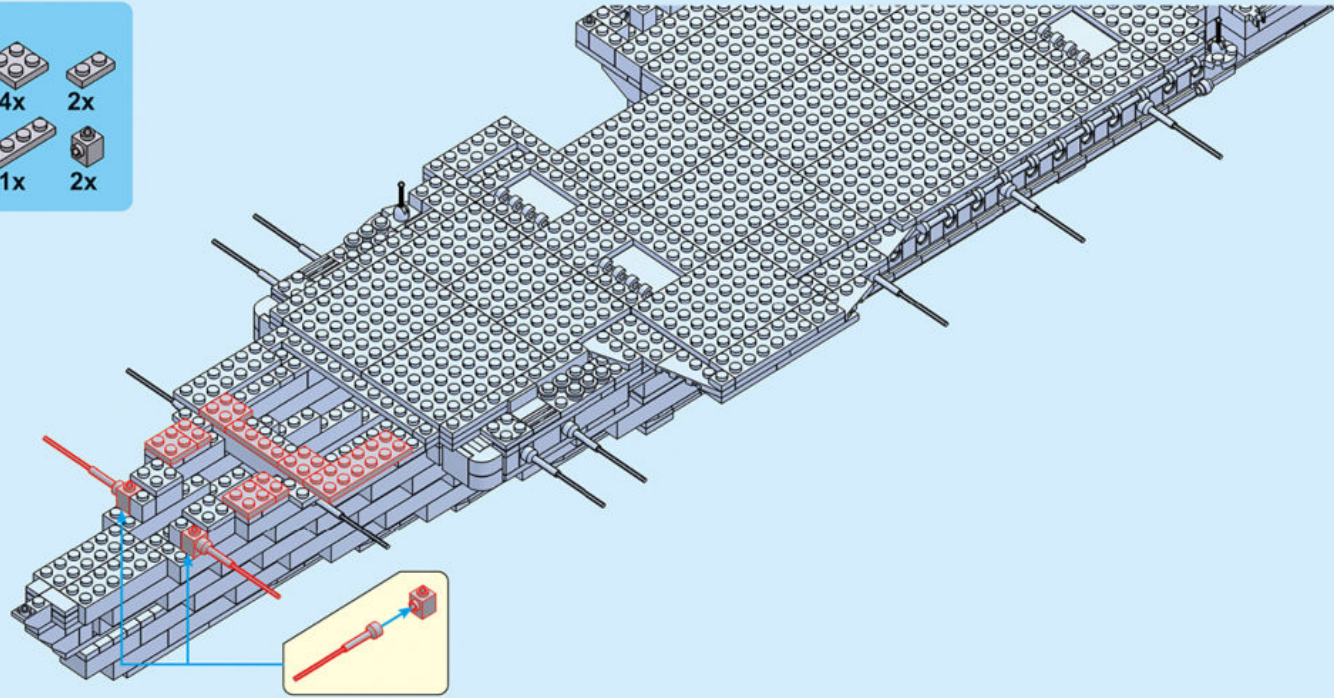

96.

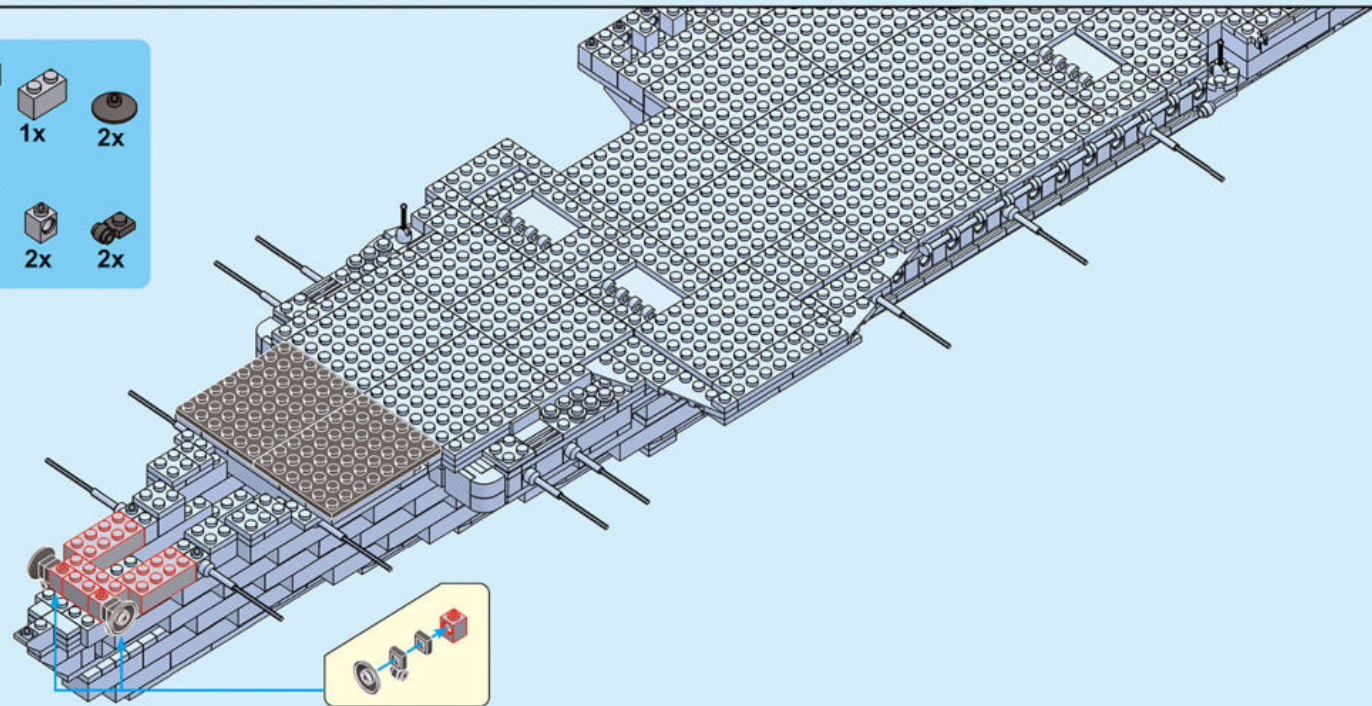

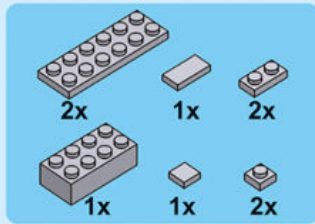

97.

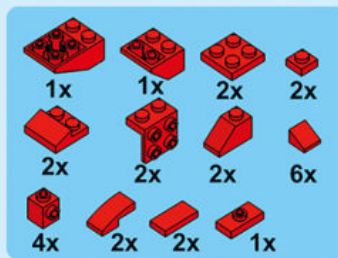
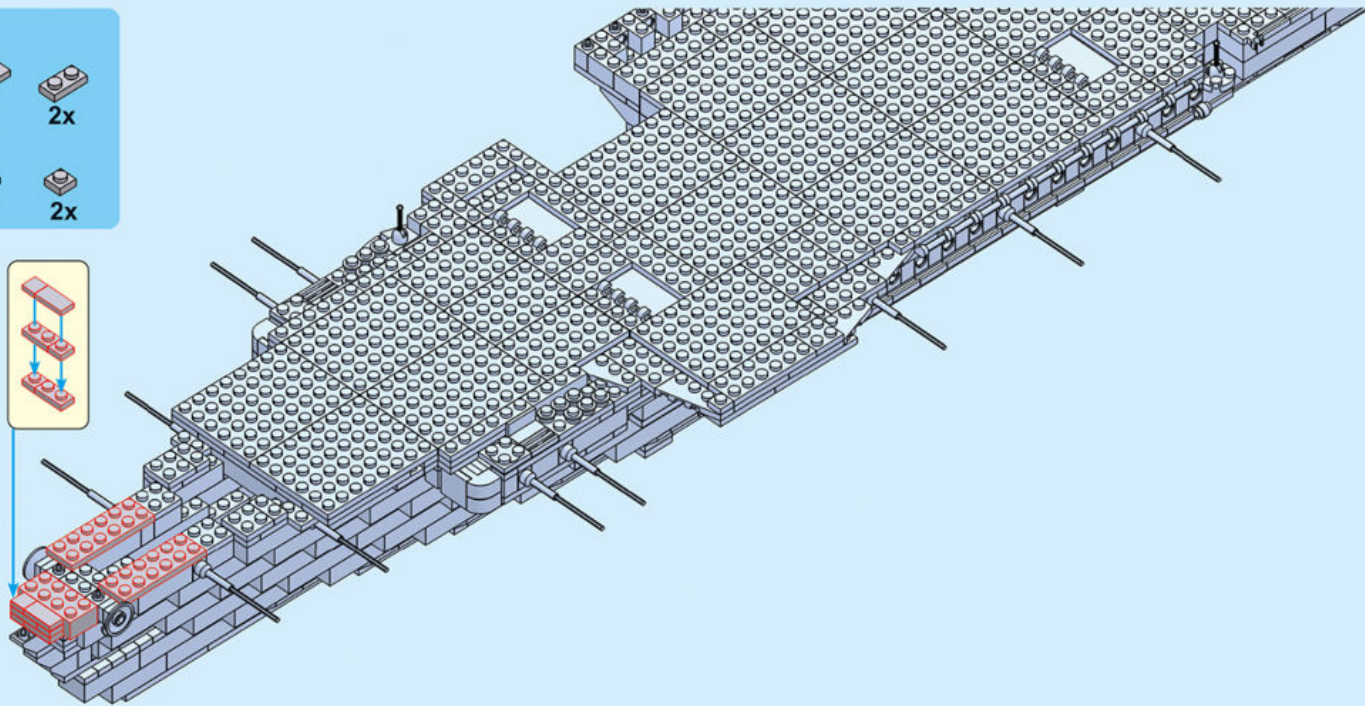
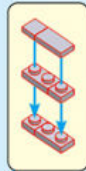

98.

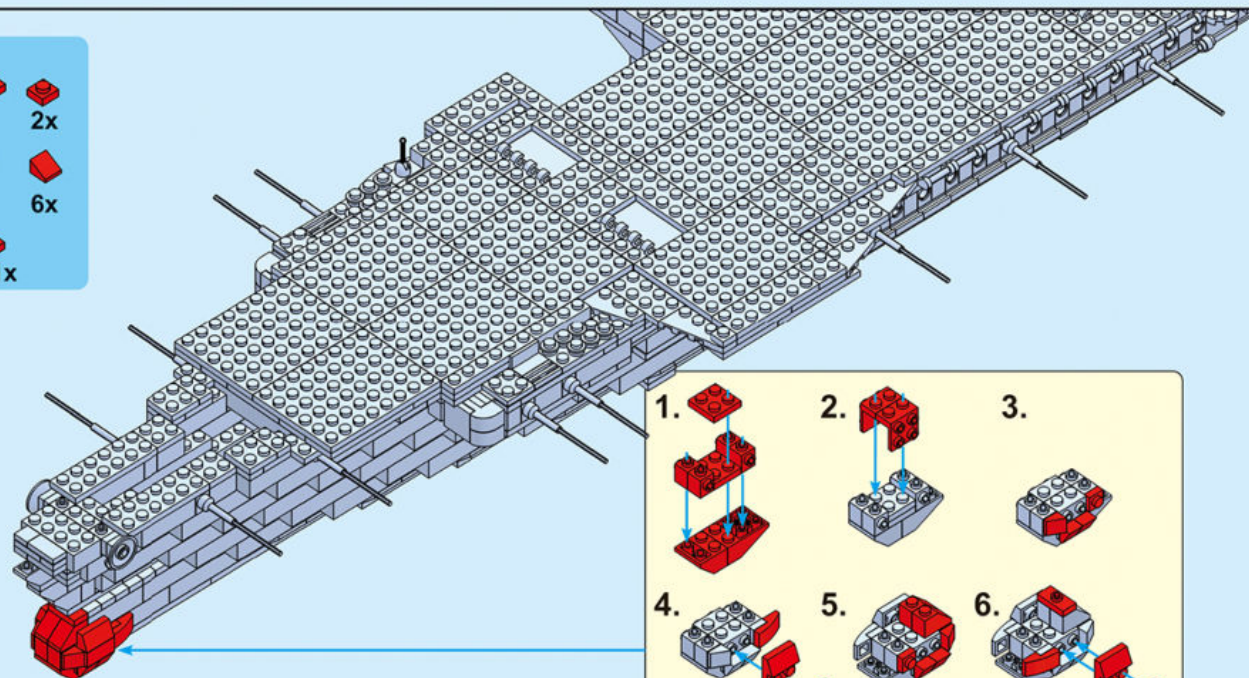
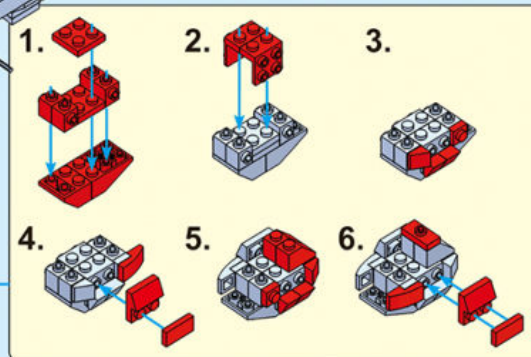

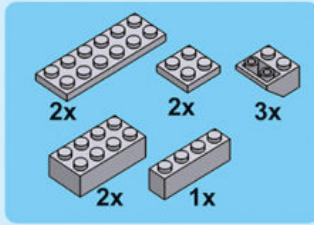

99.

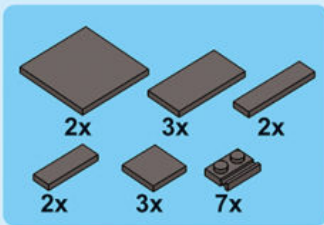
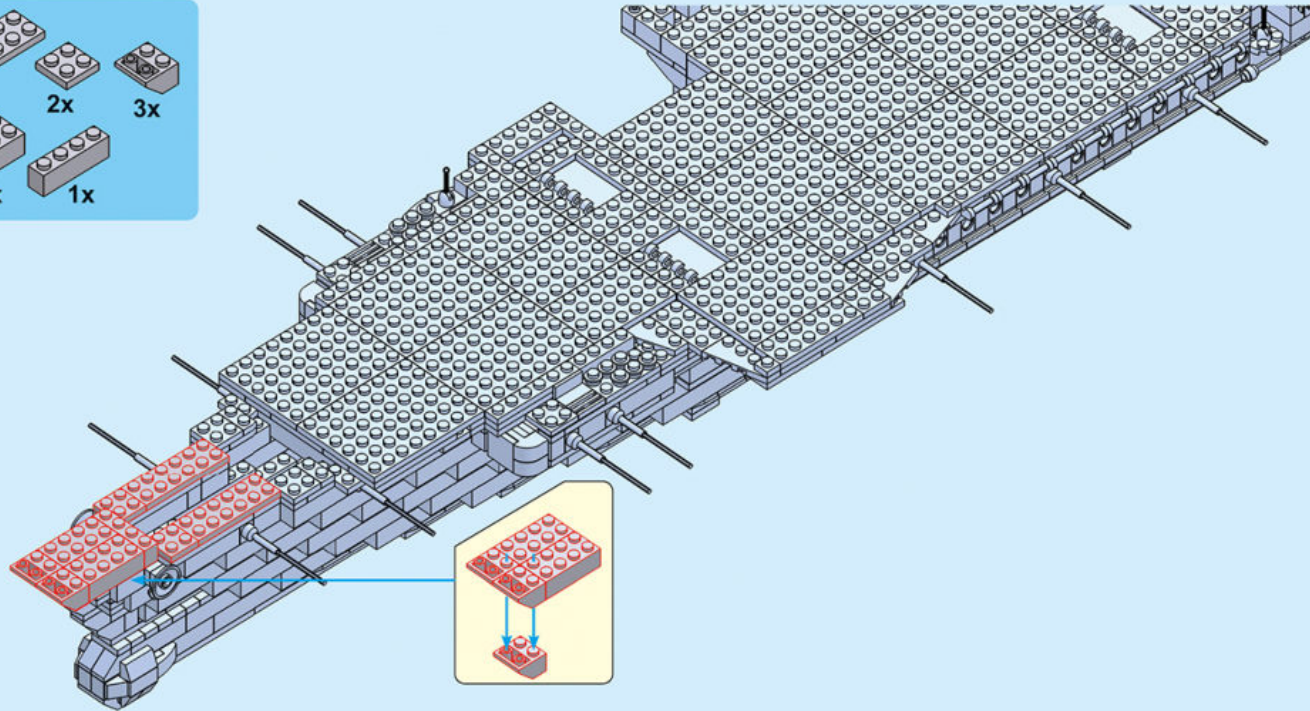

100.

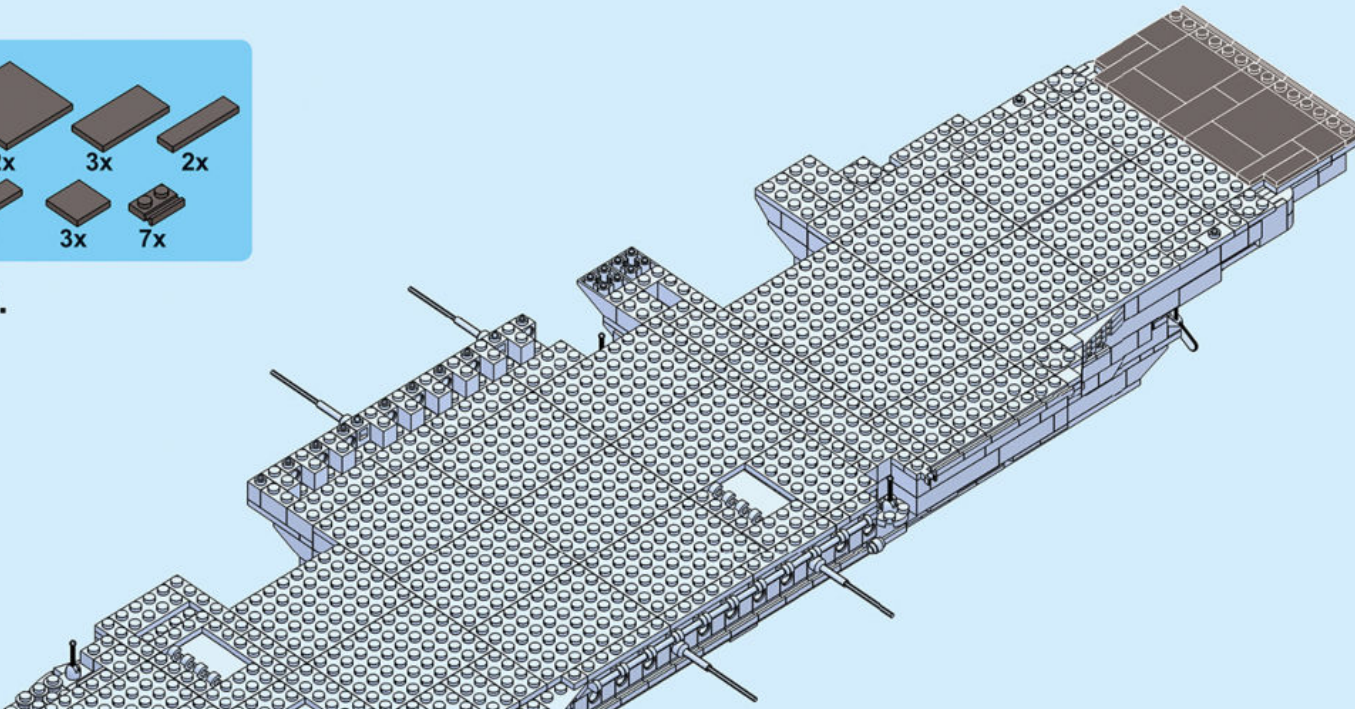



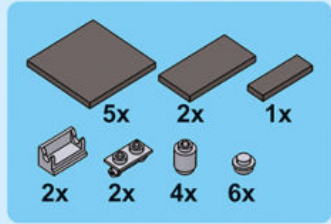

101.

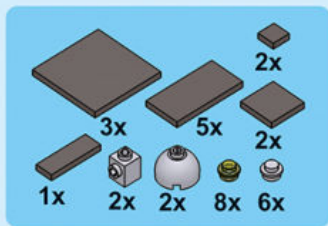
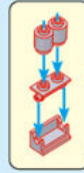
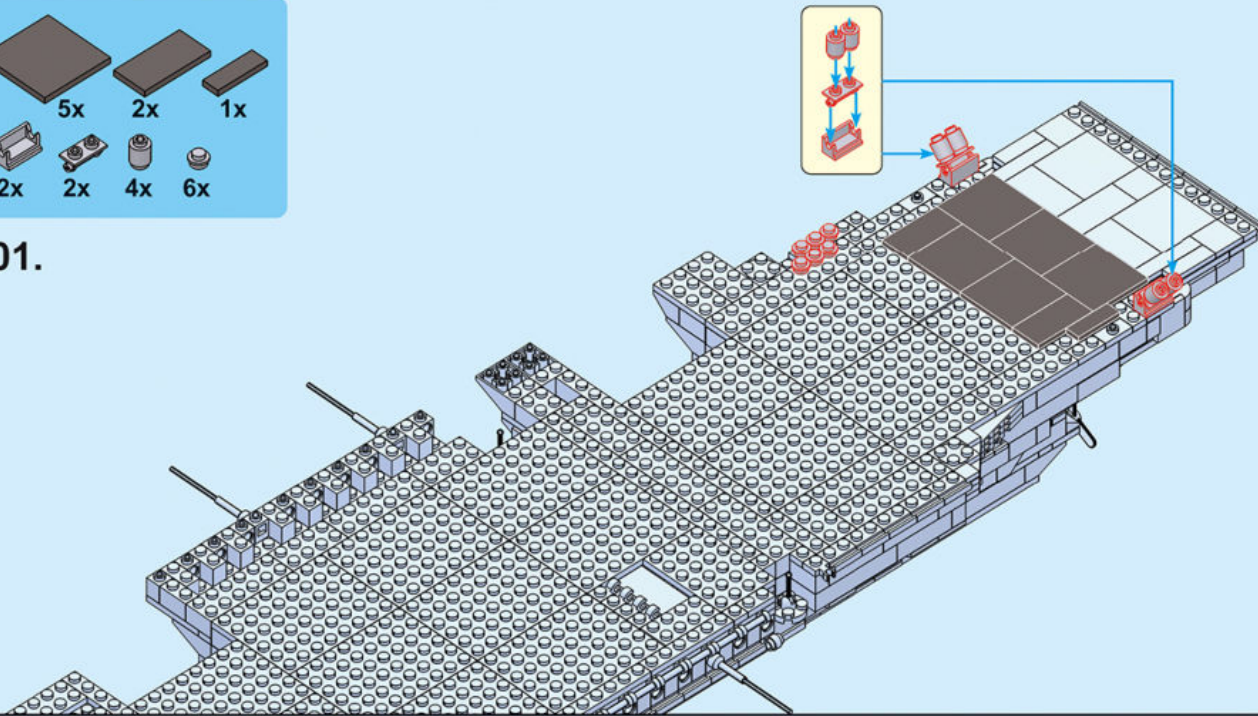

102.

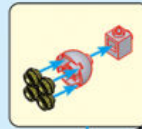
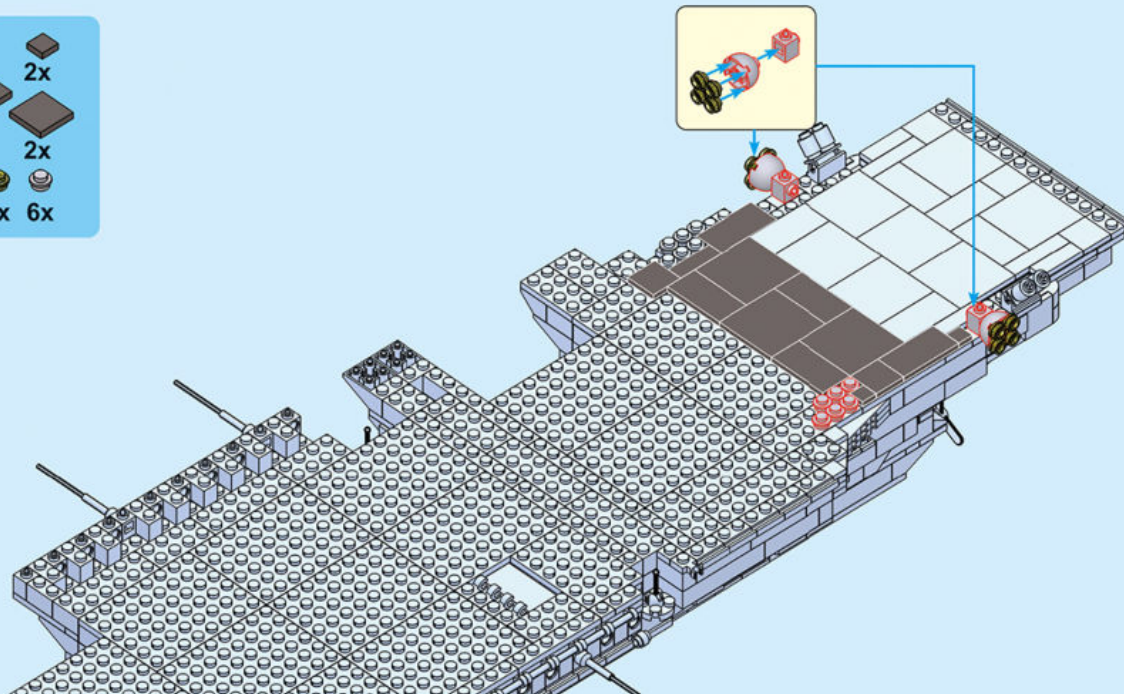

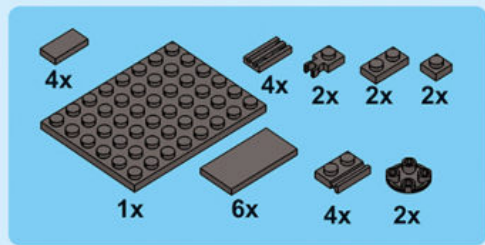

103.

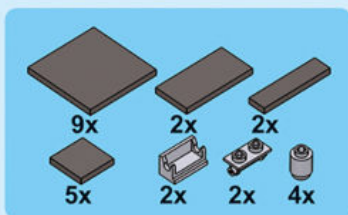
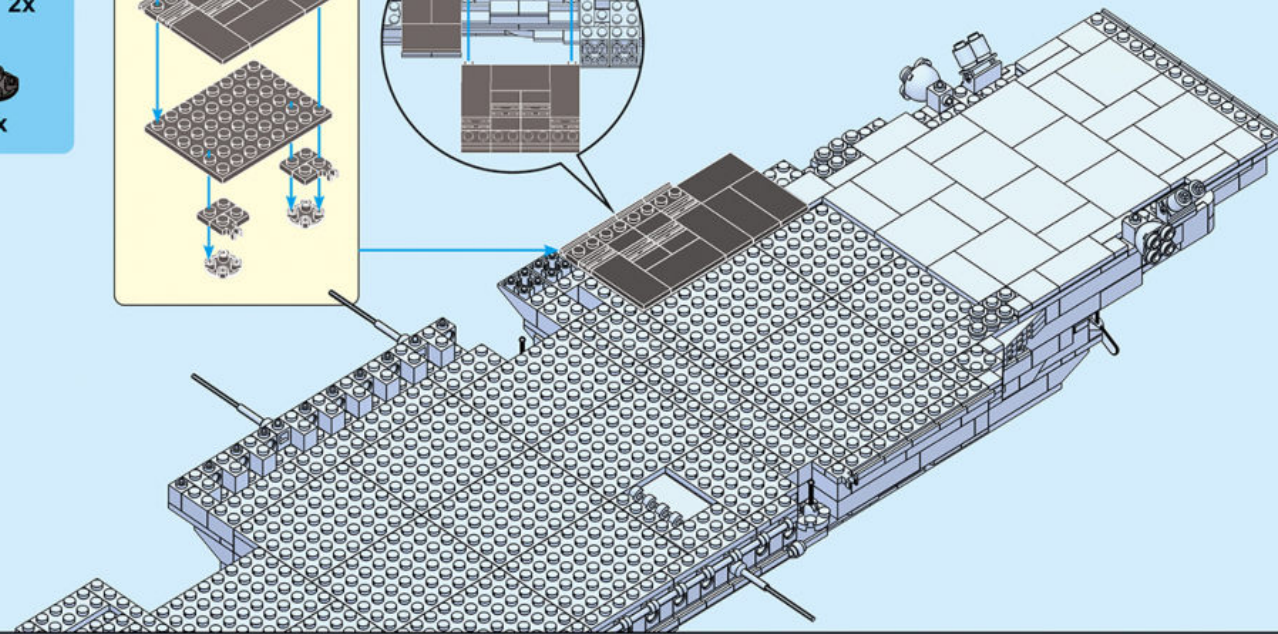
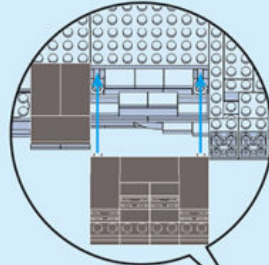
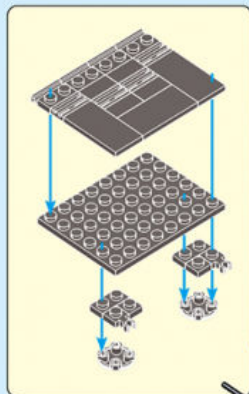

104.

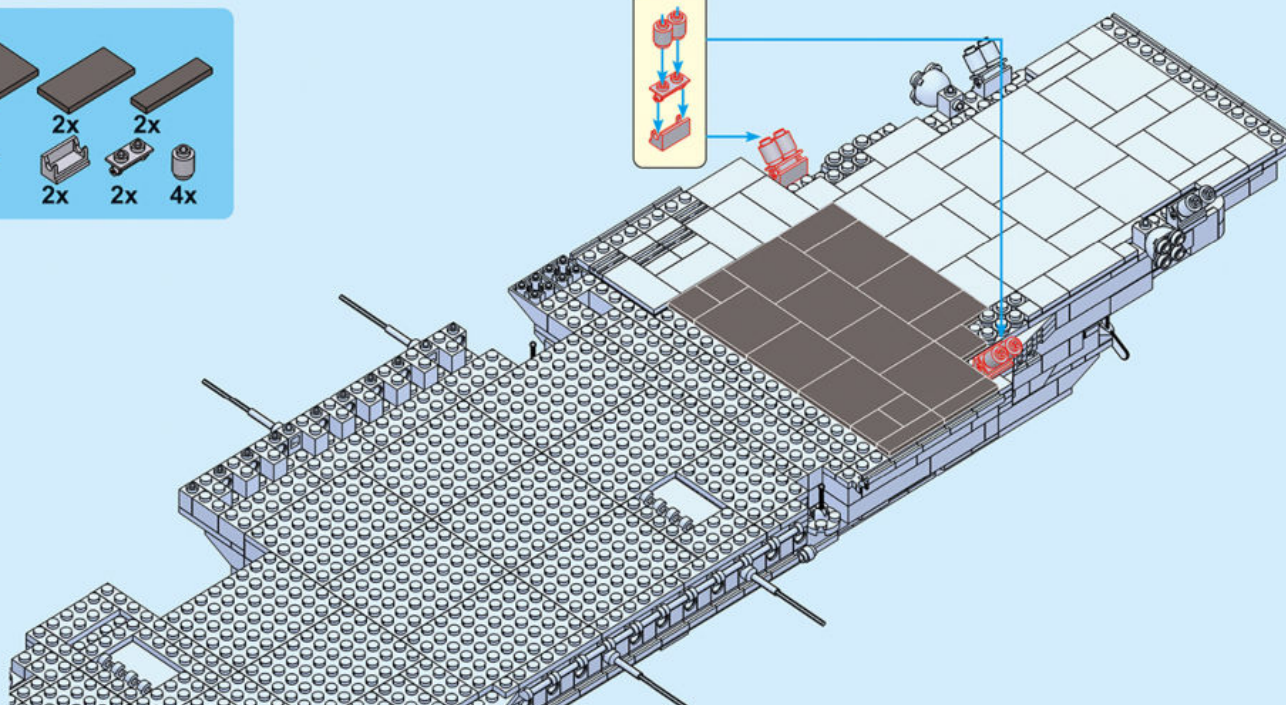
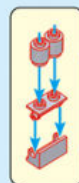

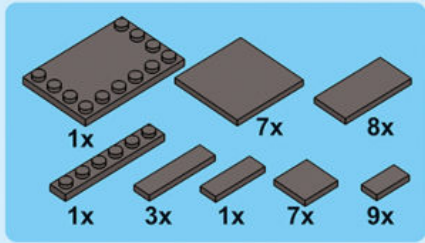

105.

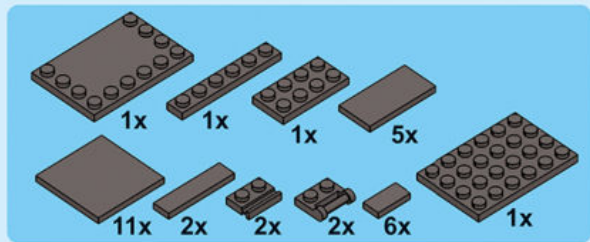
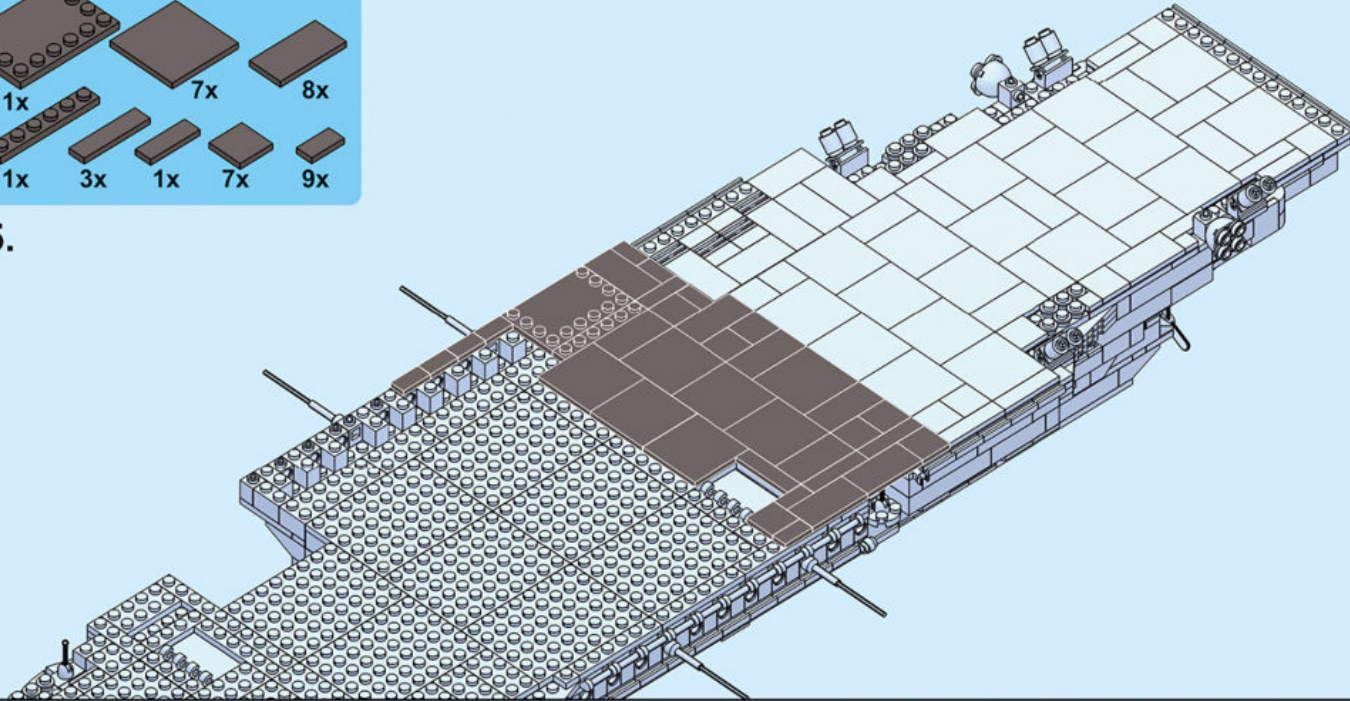

106.

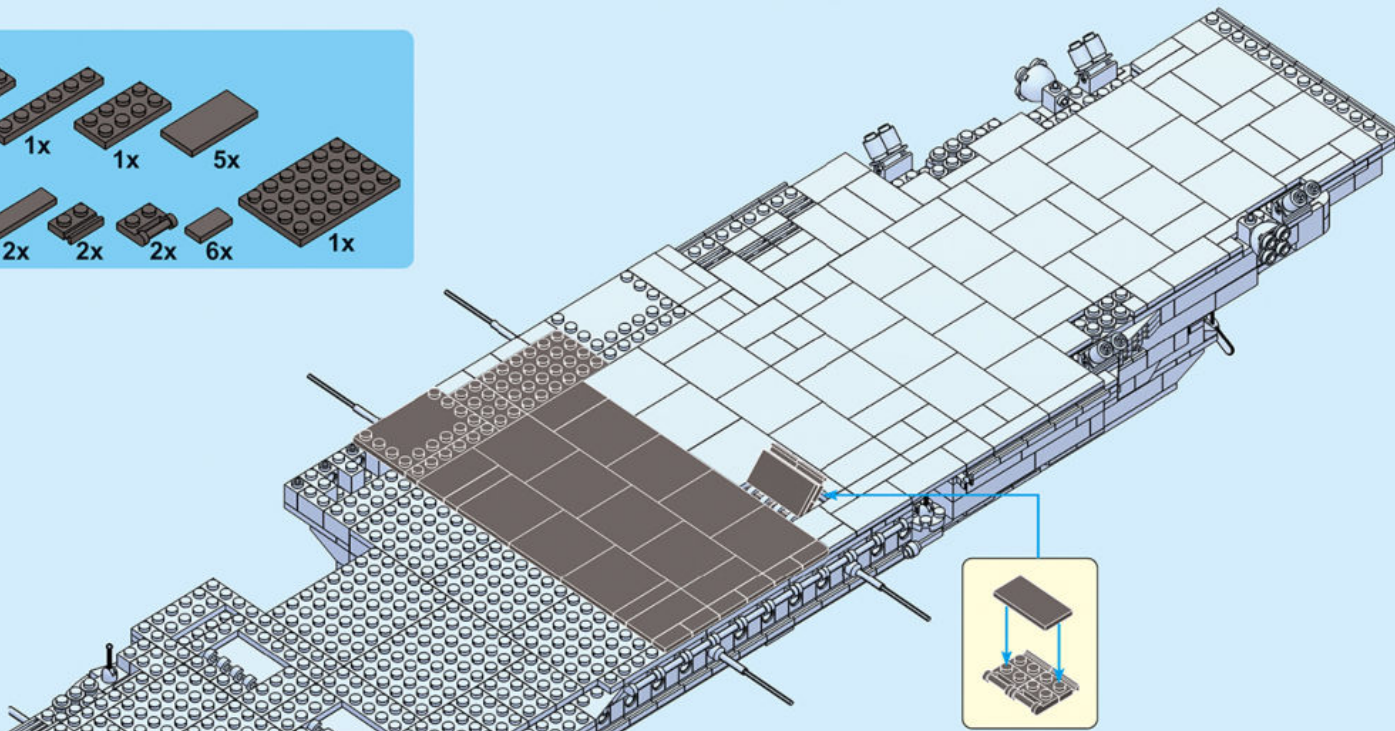

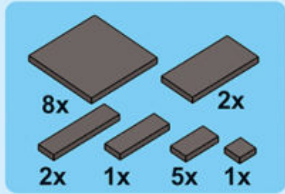

107.

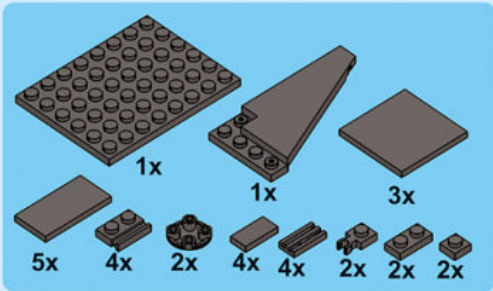
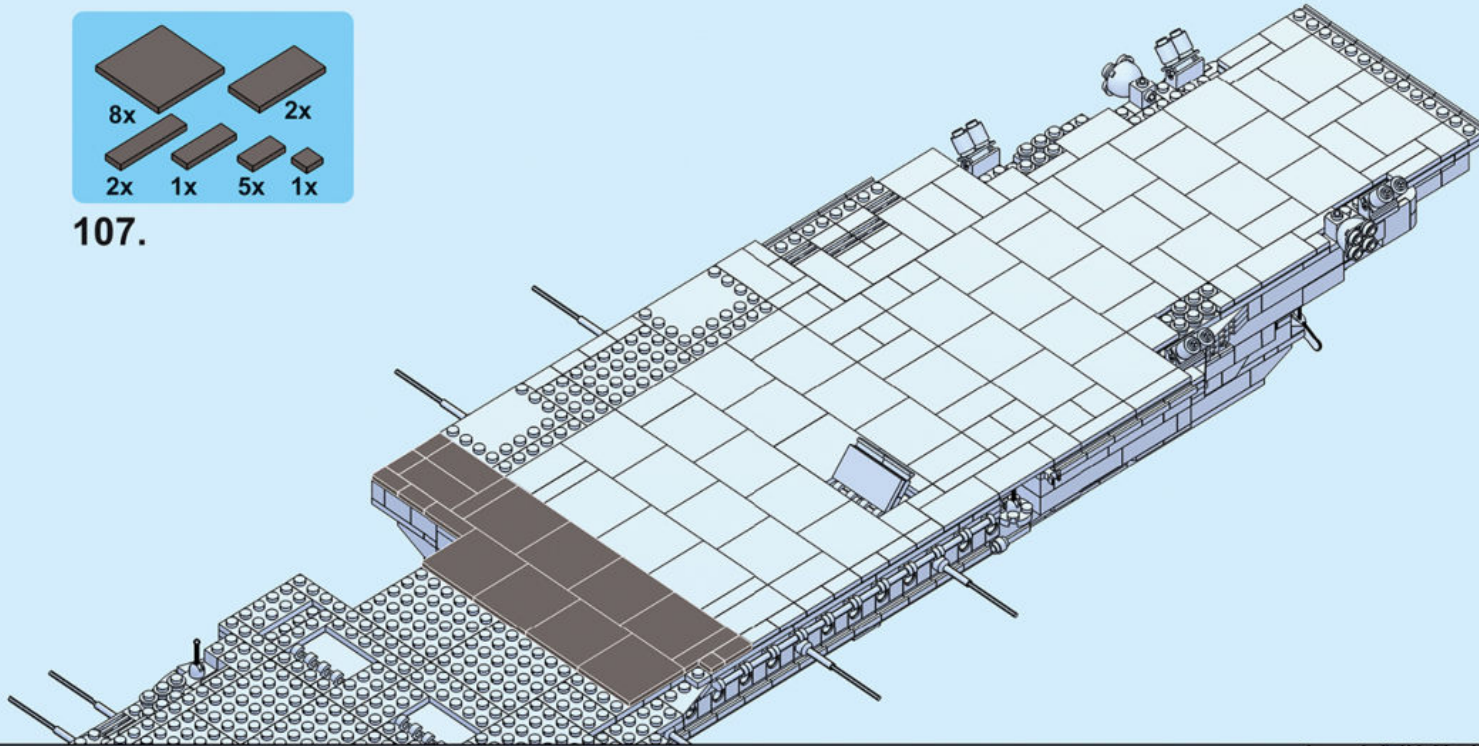

108.

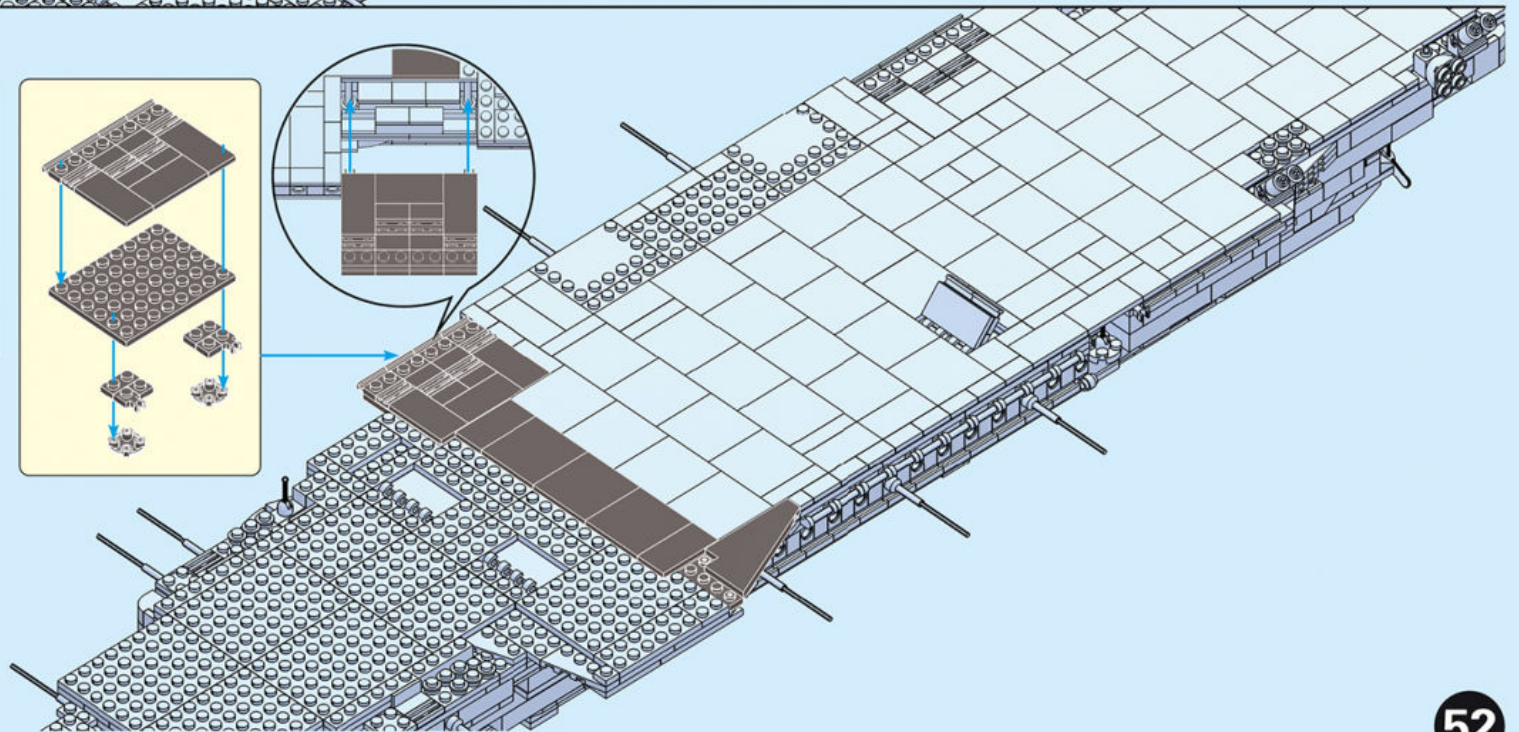
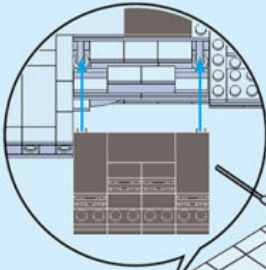
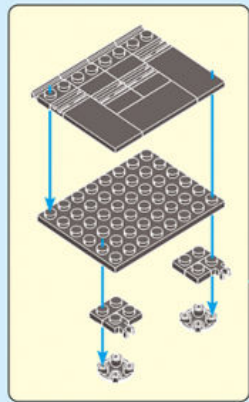

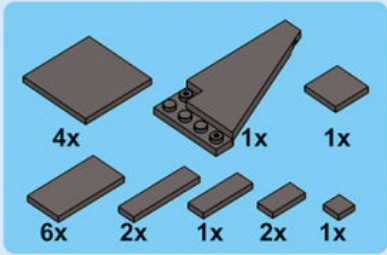

109.

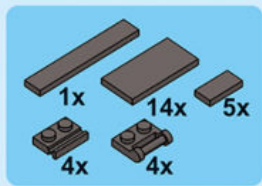
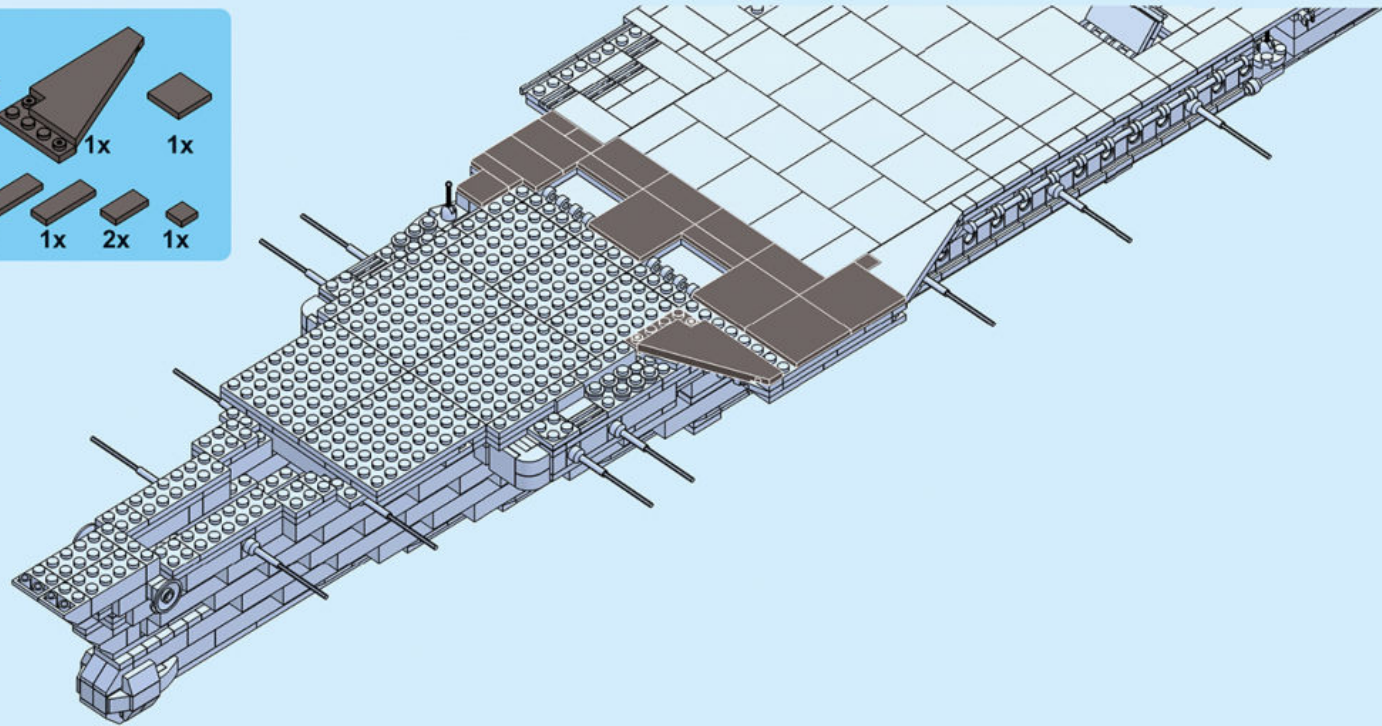

110.

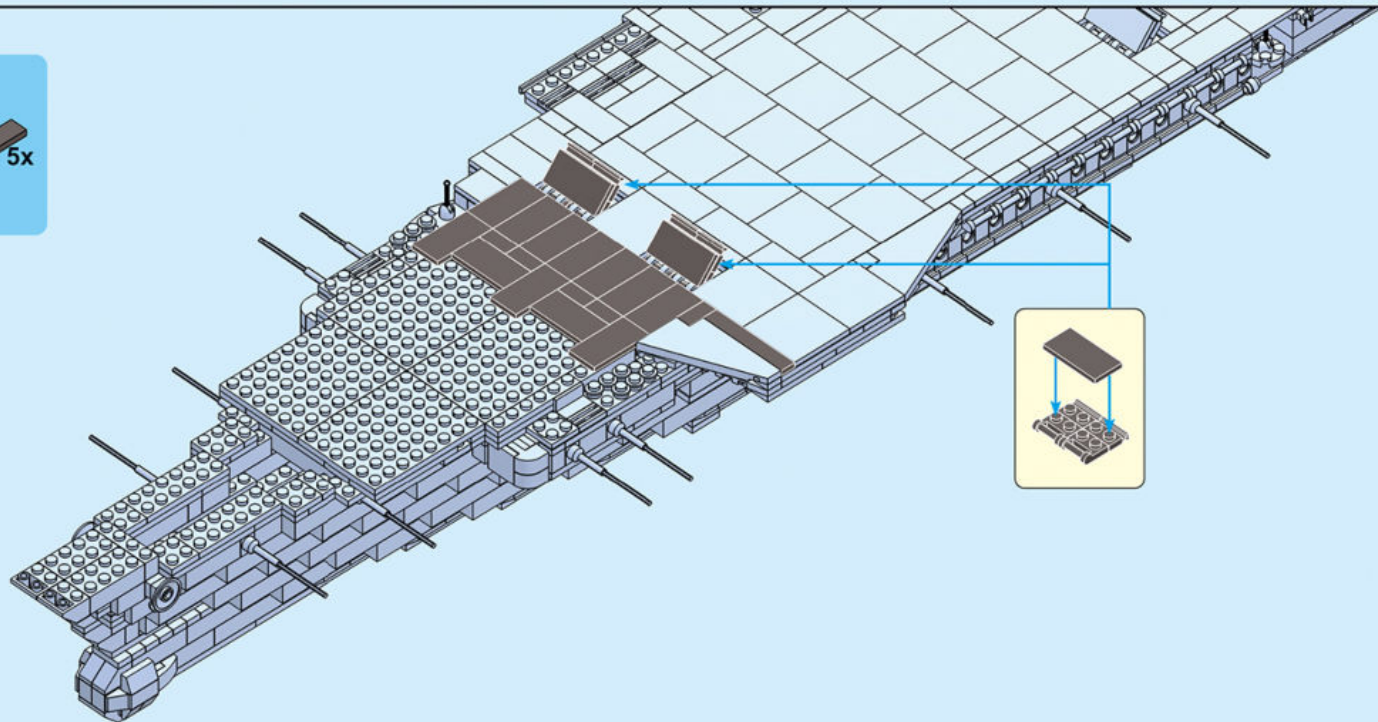

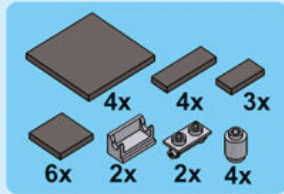

111.

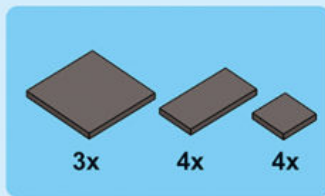
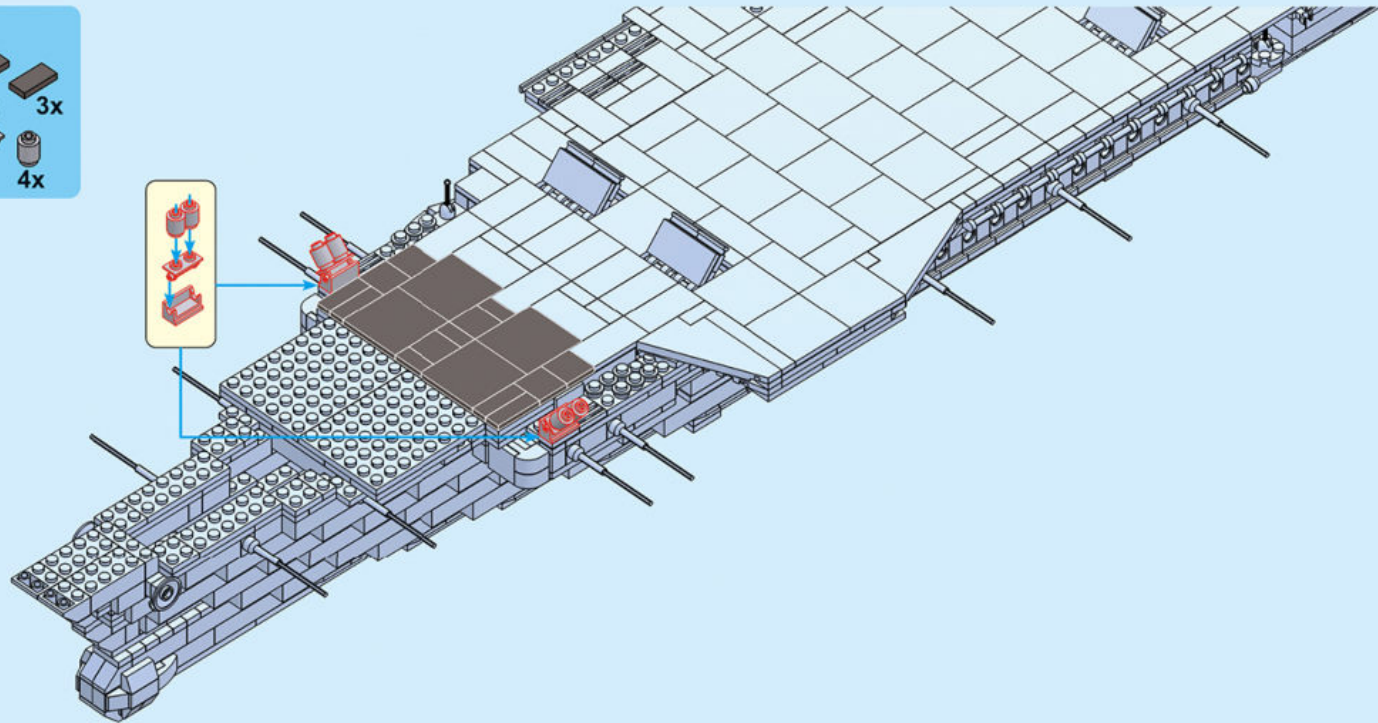

112.

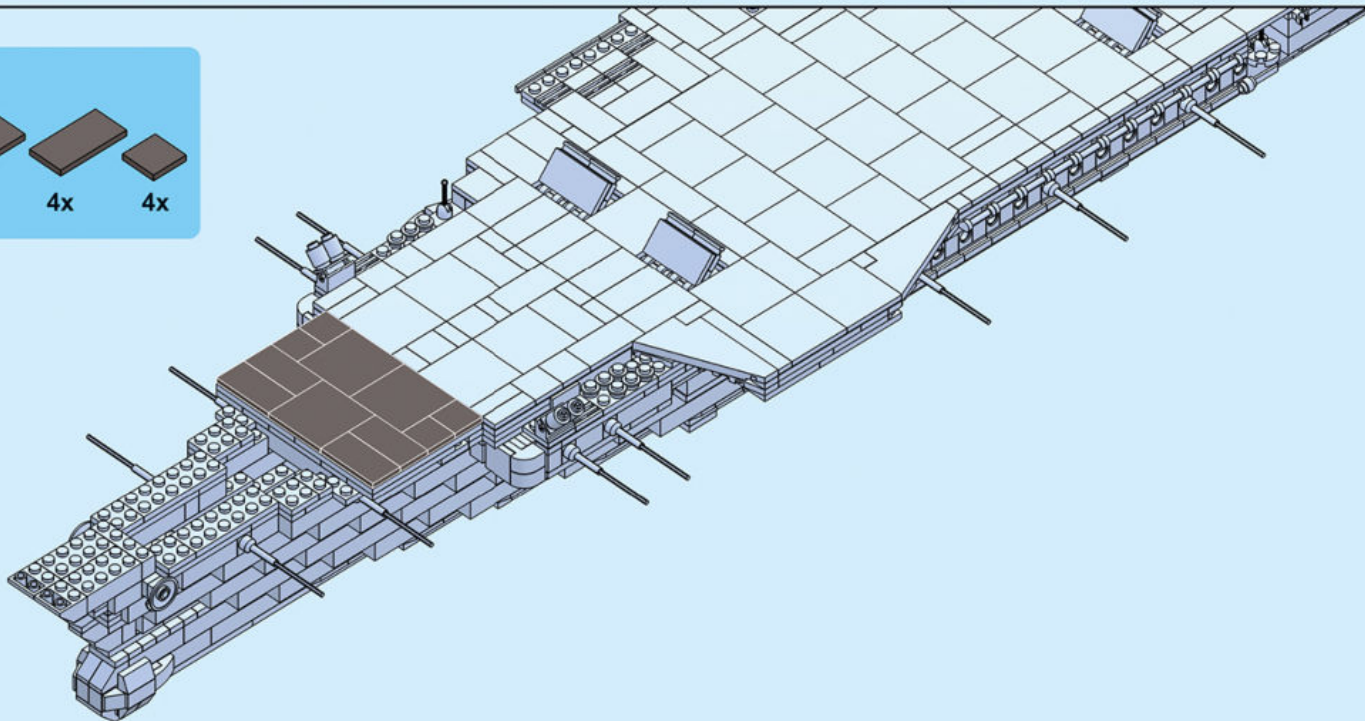

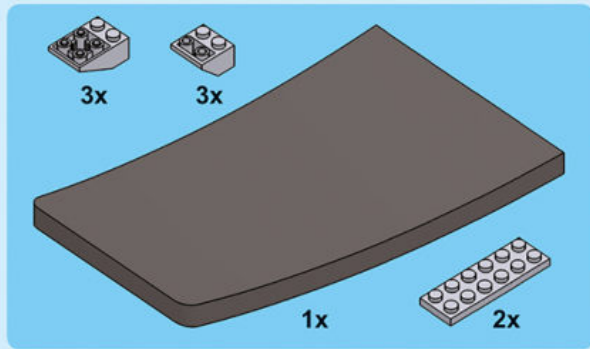

113.

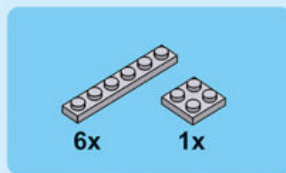
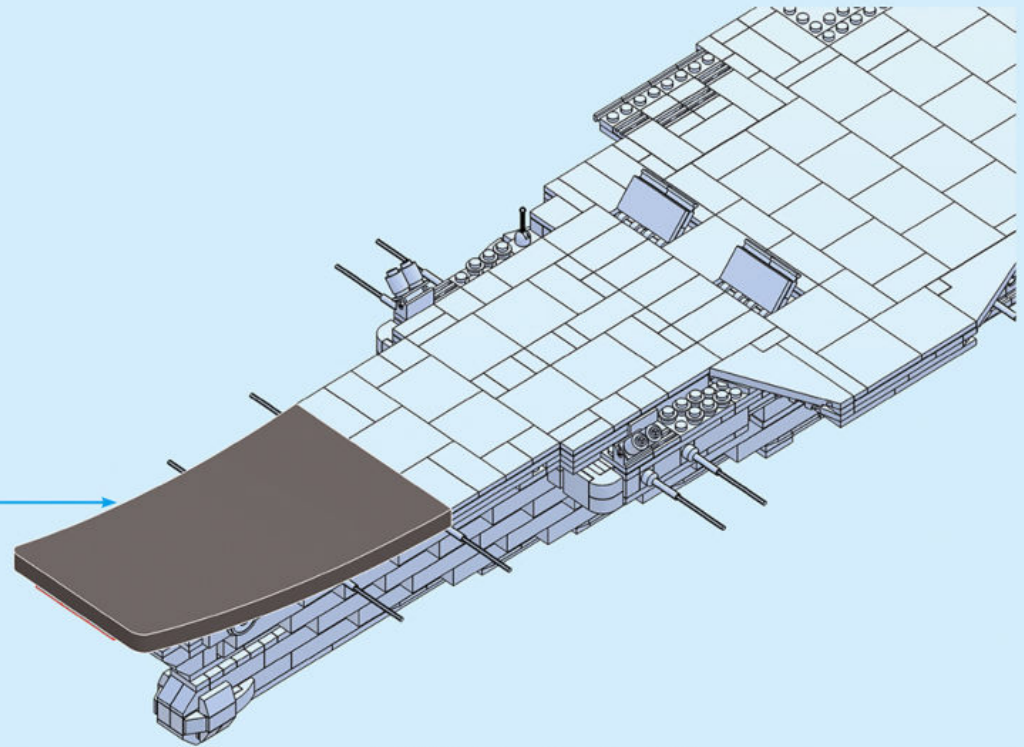
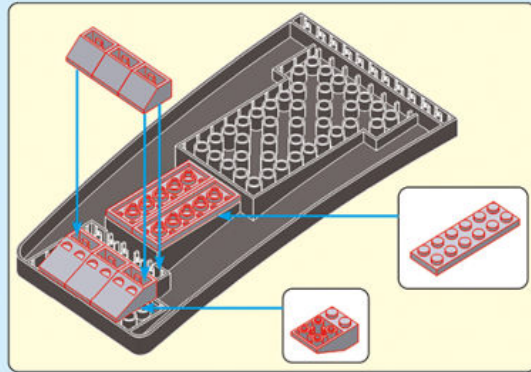

114.

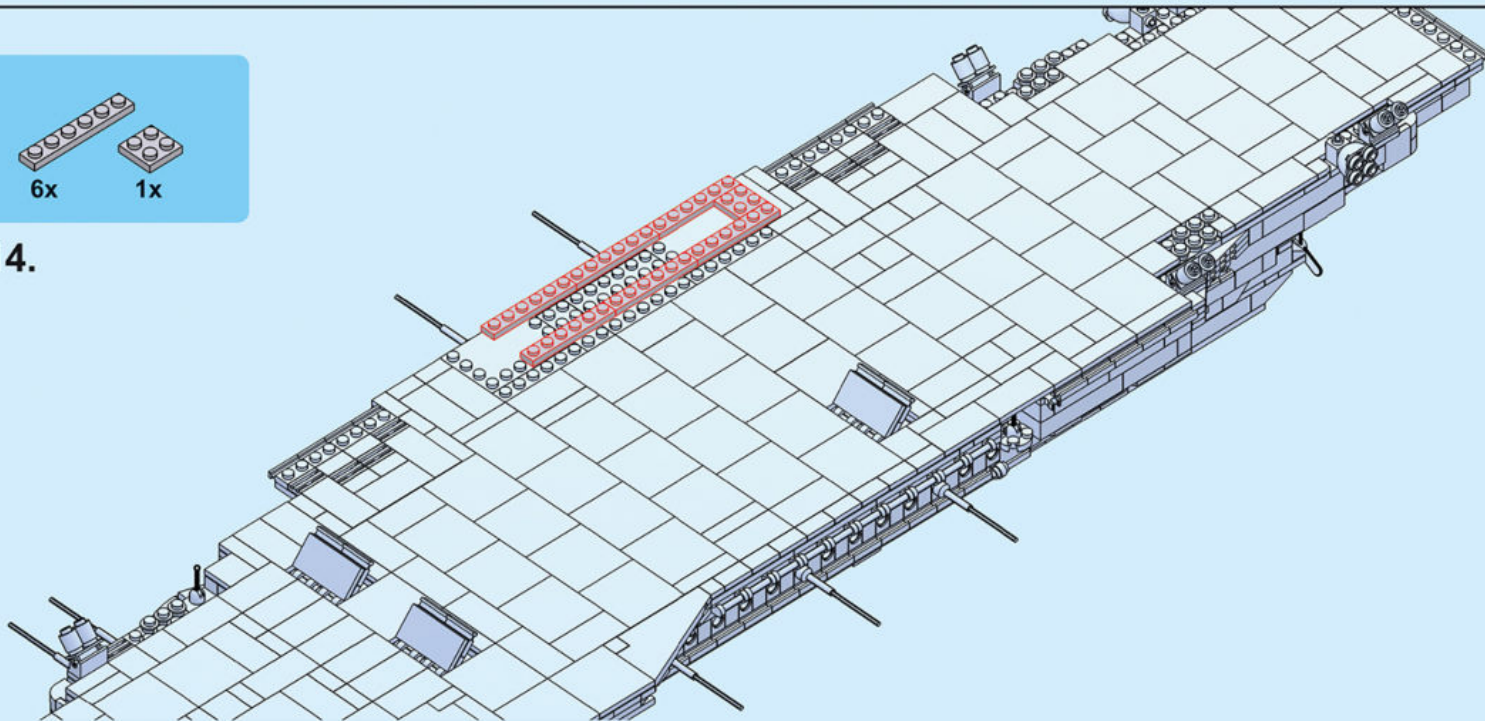

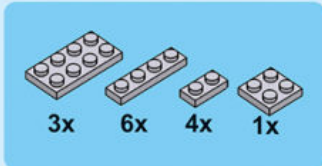

115.

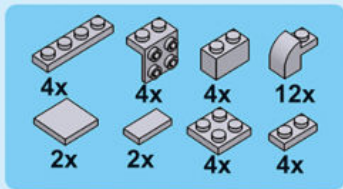
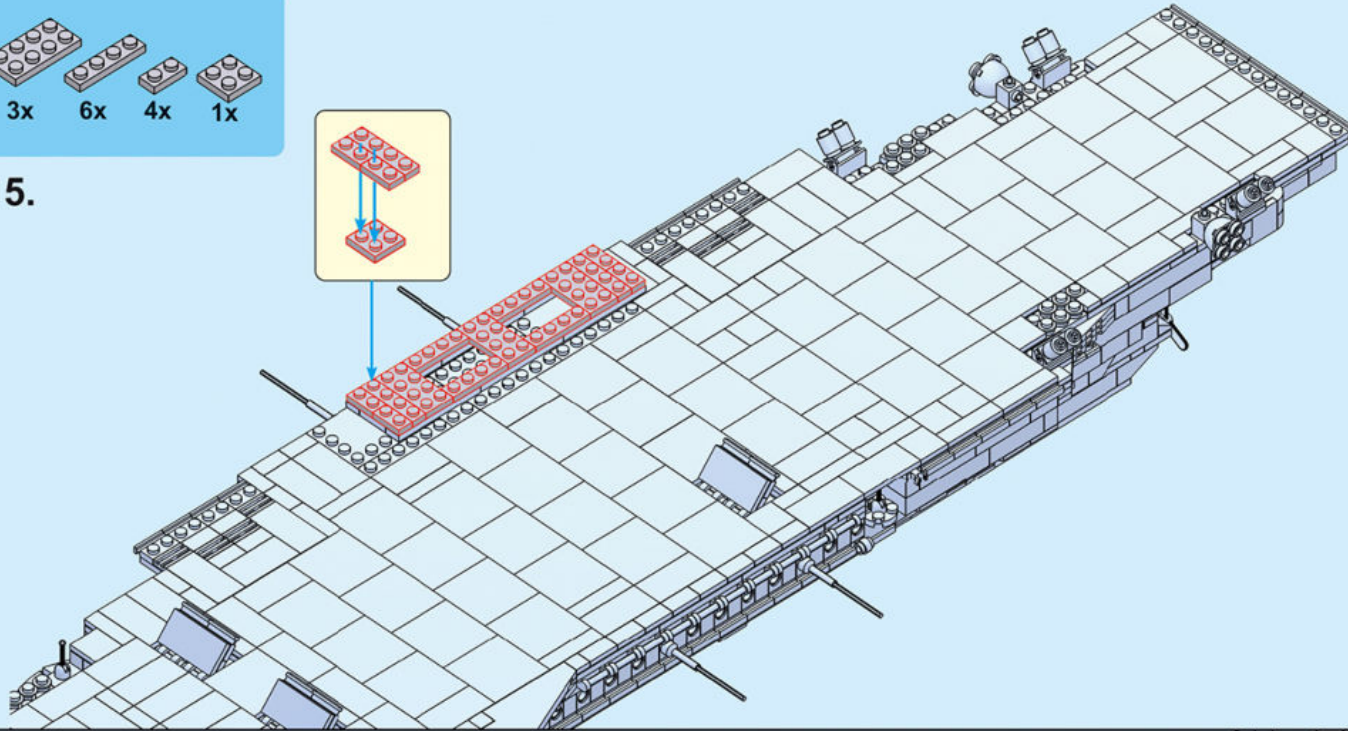
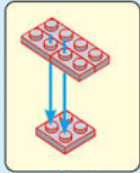

116.

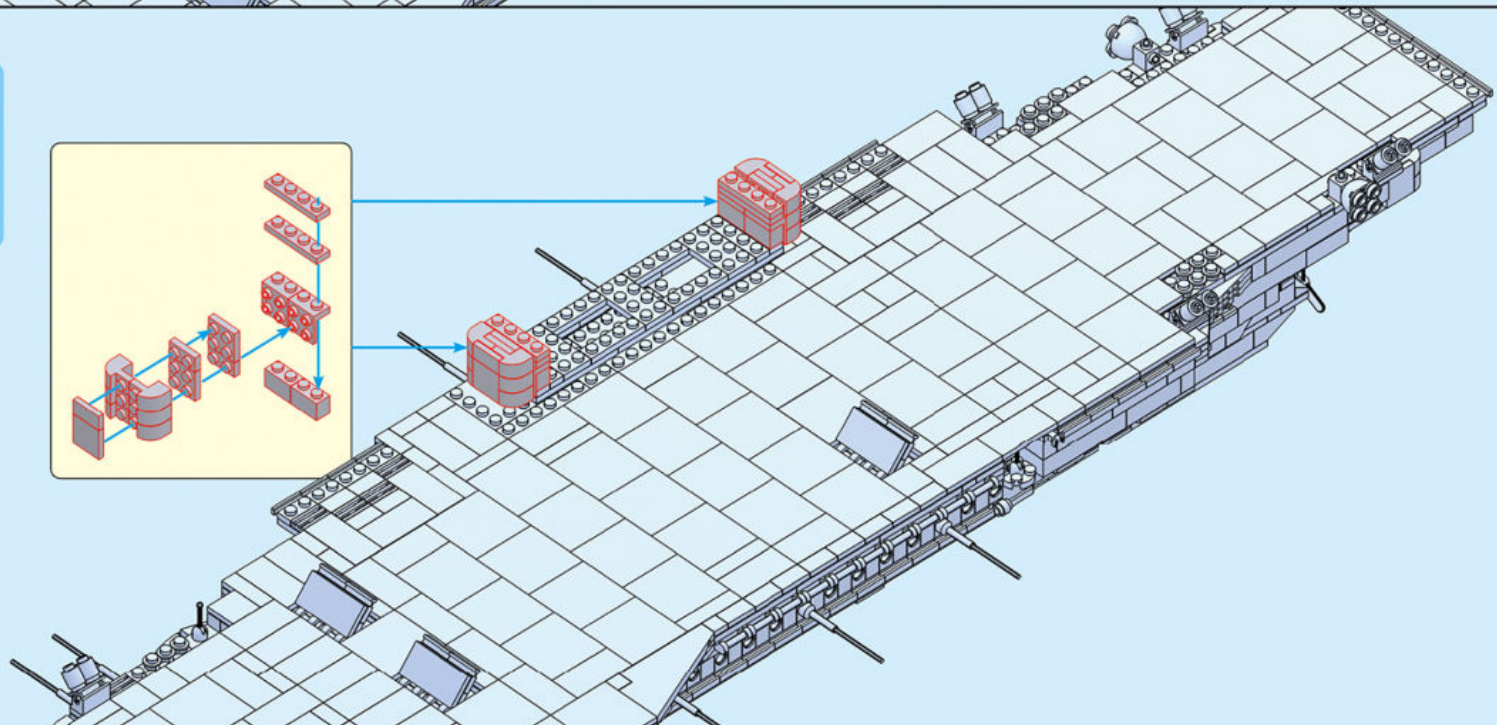
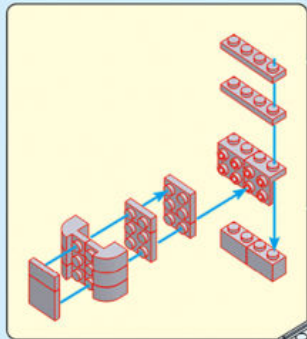



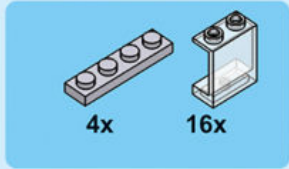

117.

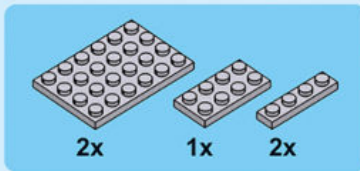
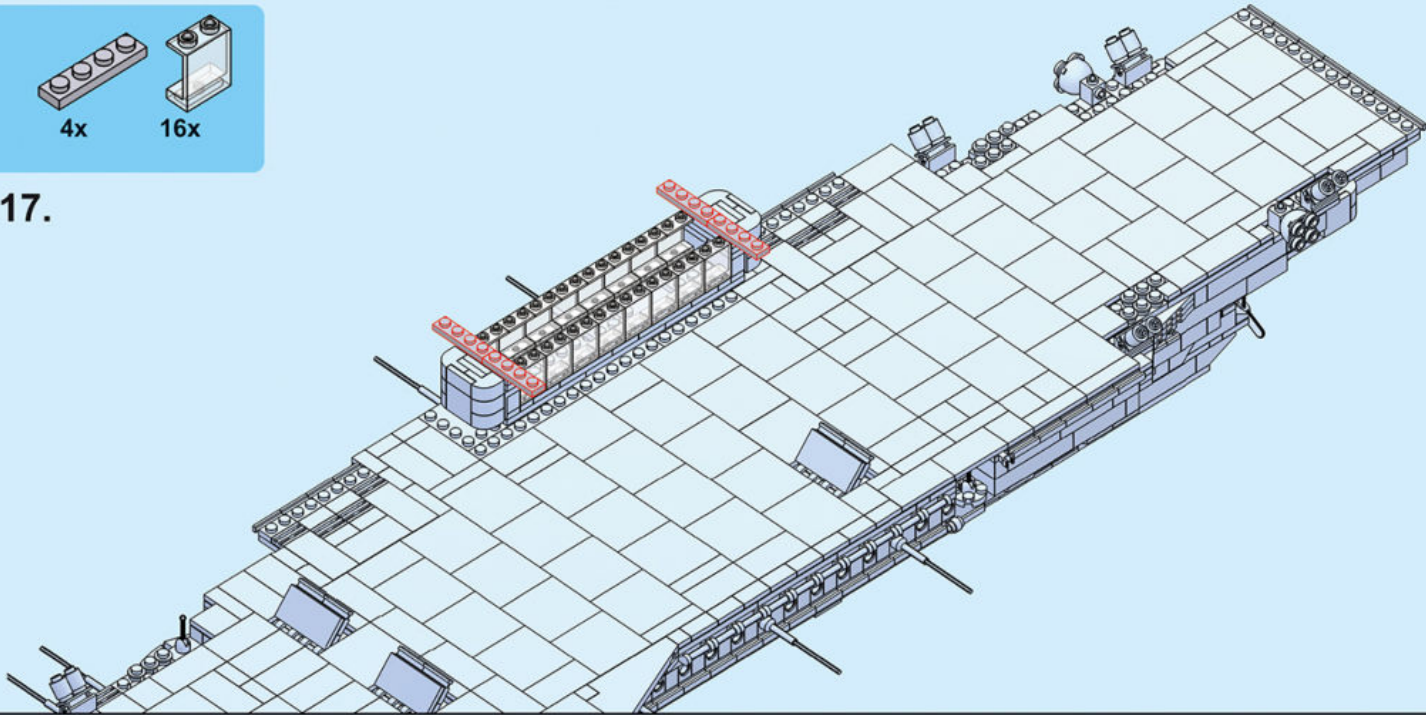

118.

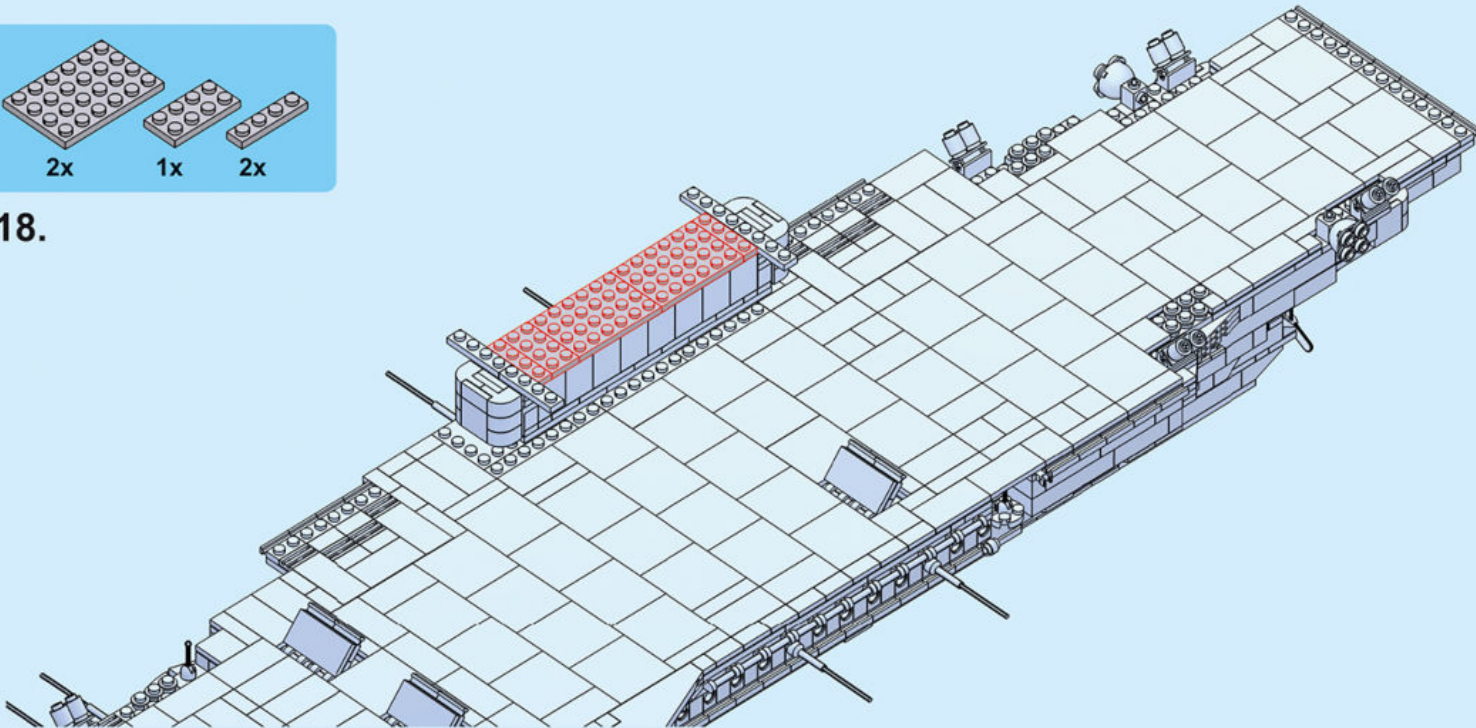

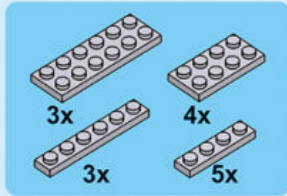

119.

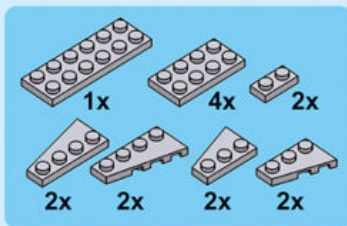
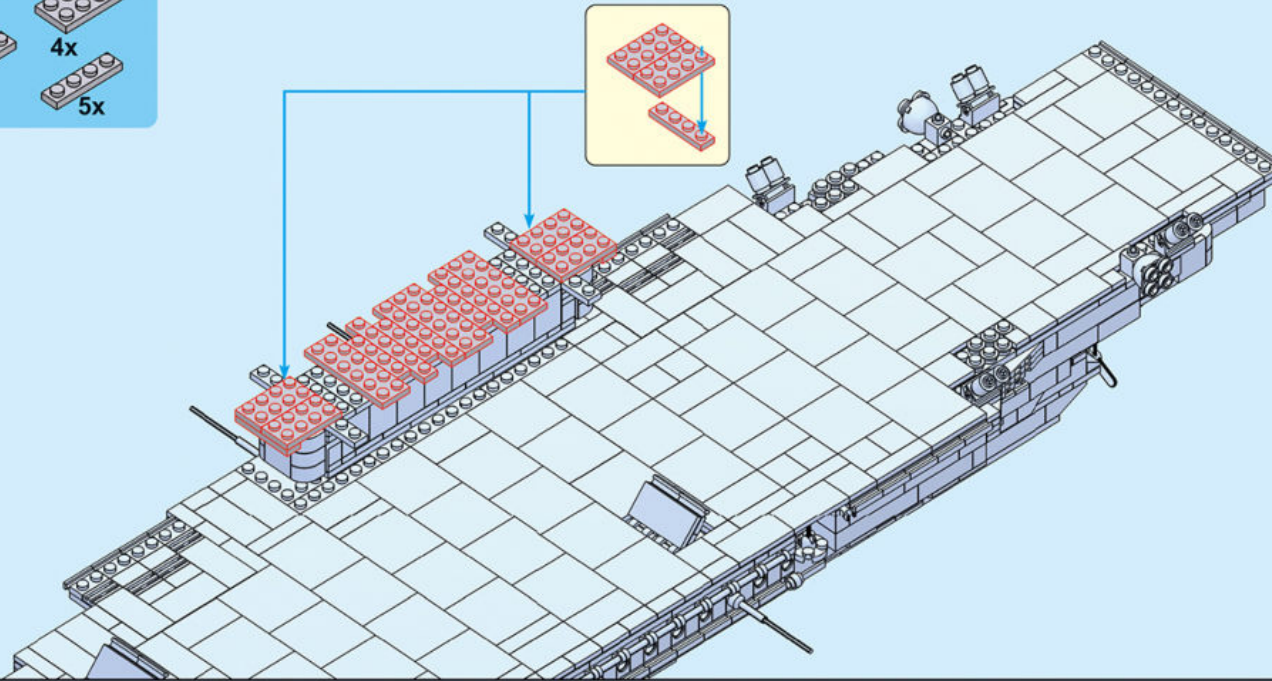

120.

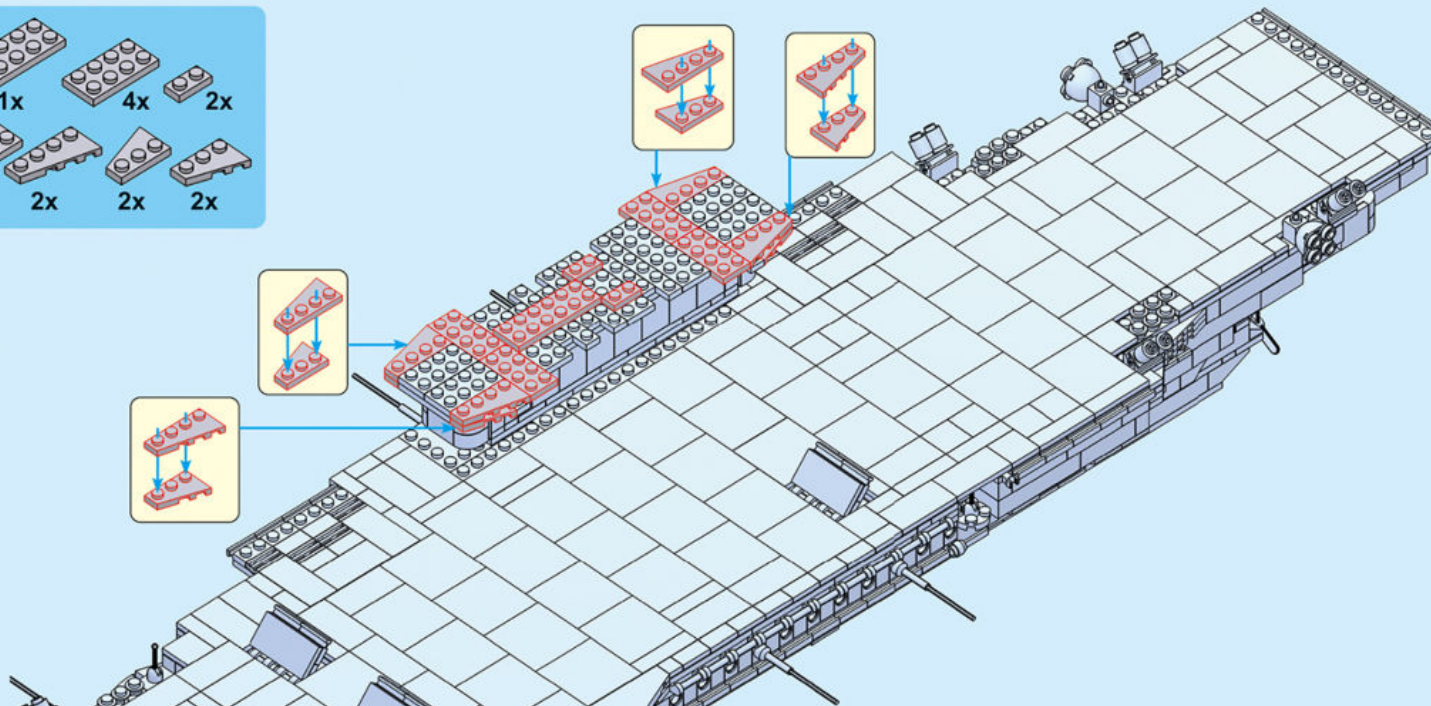

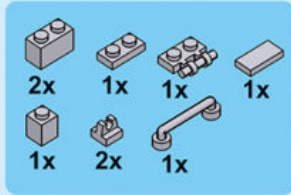



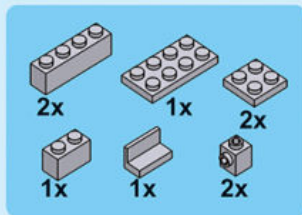
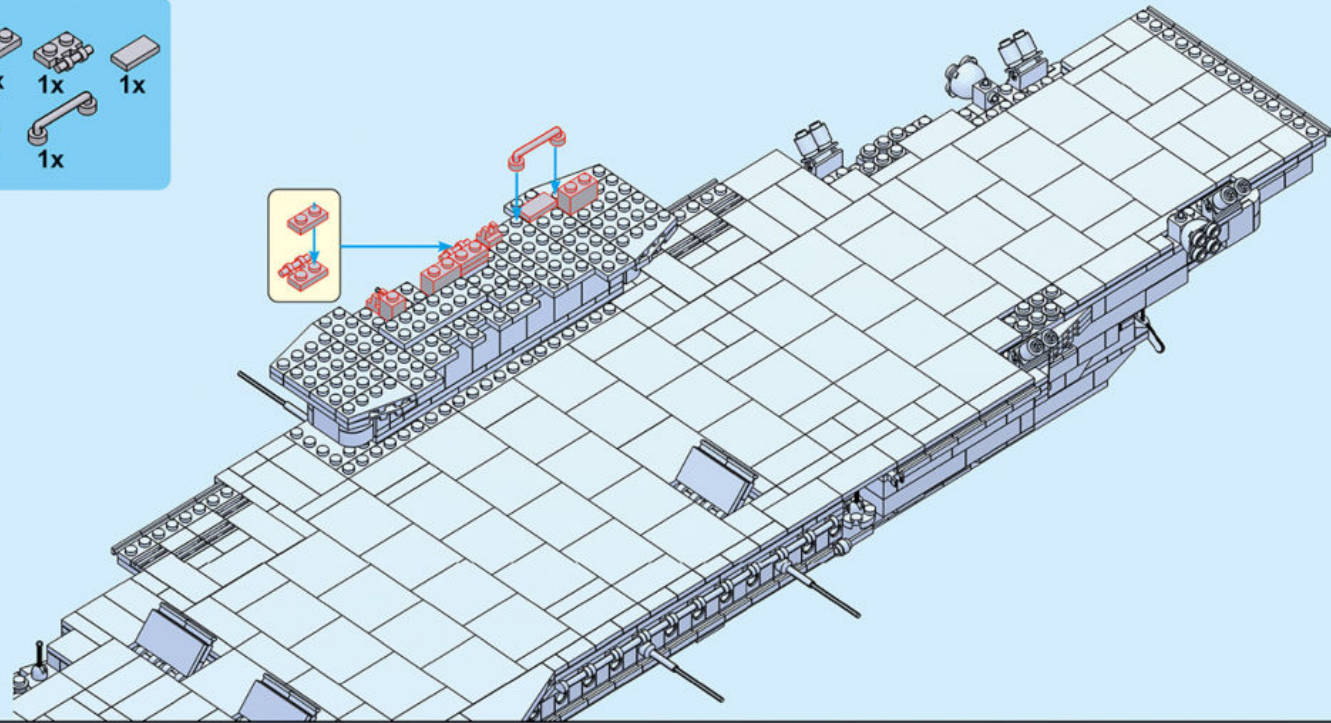



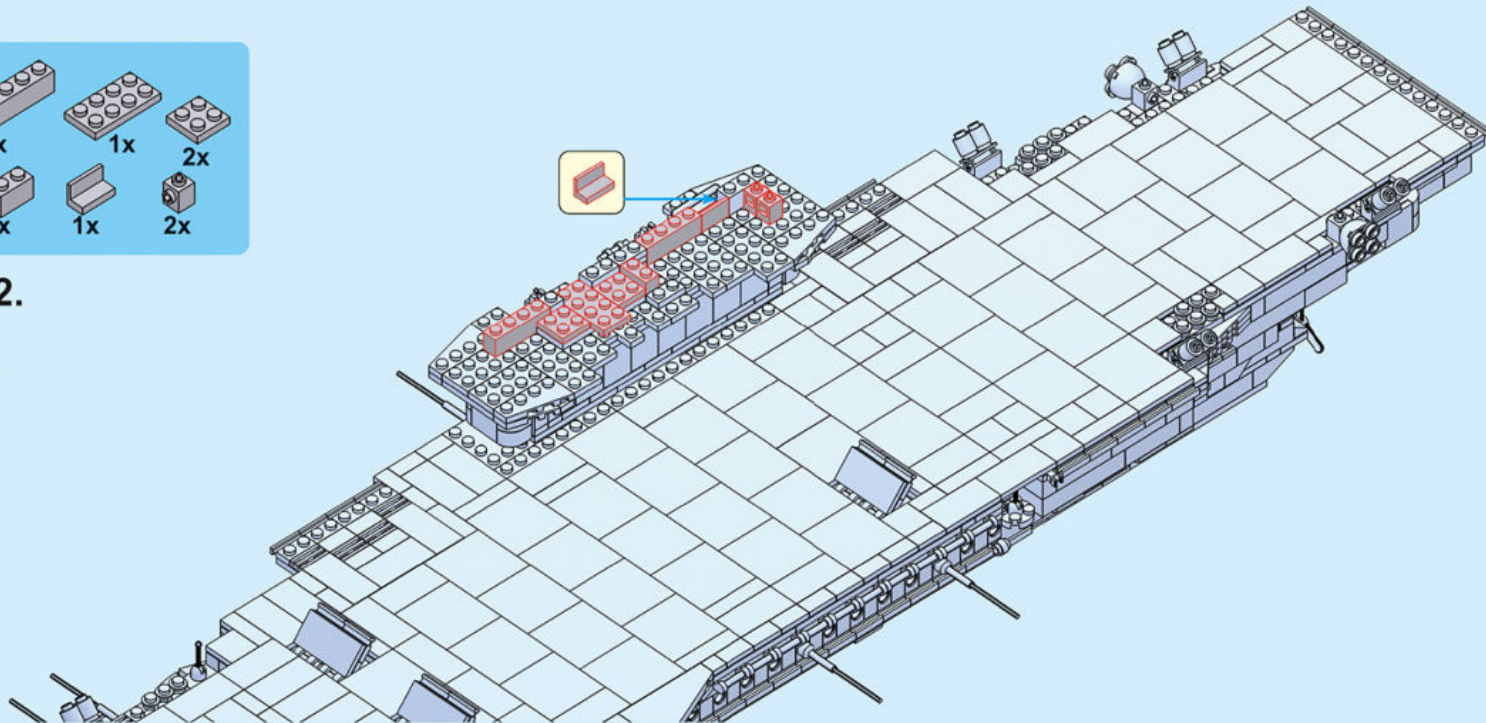

121.



122.







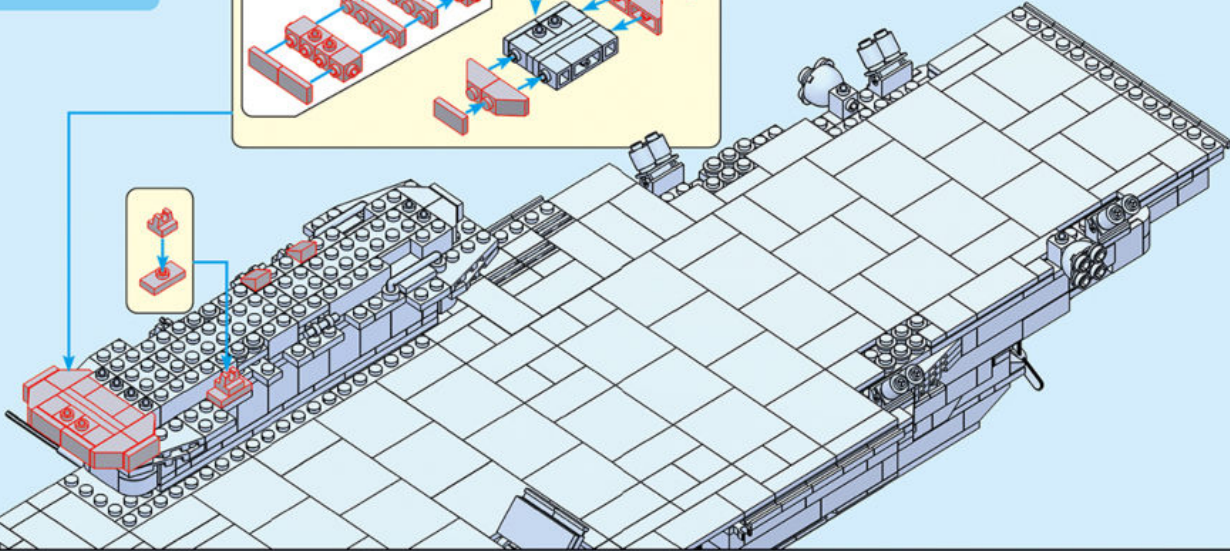
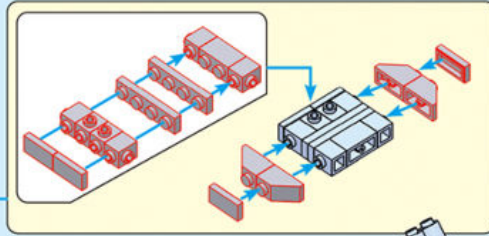

- 2x 
- 1x 
- 4x 
- 6x 
- 1x 
- 4x 
- 1x 
- 2x 

125.



- 4x 
- 1x 
- 1x 
- 2x 

126.

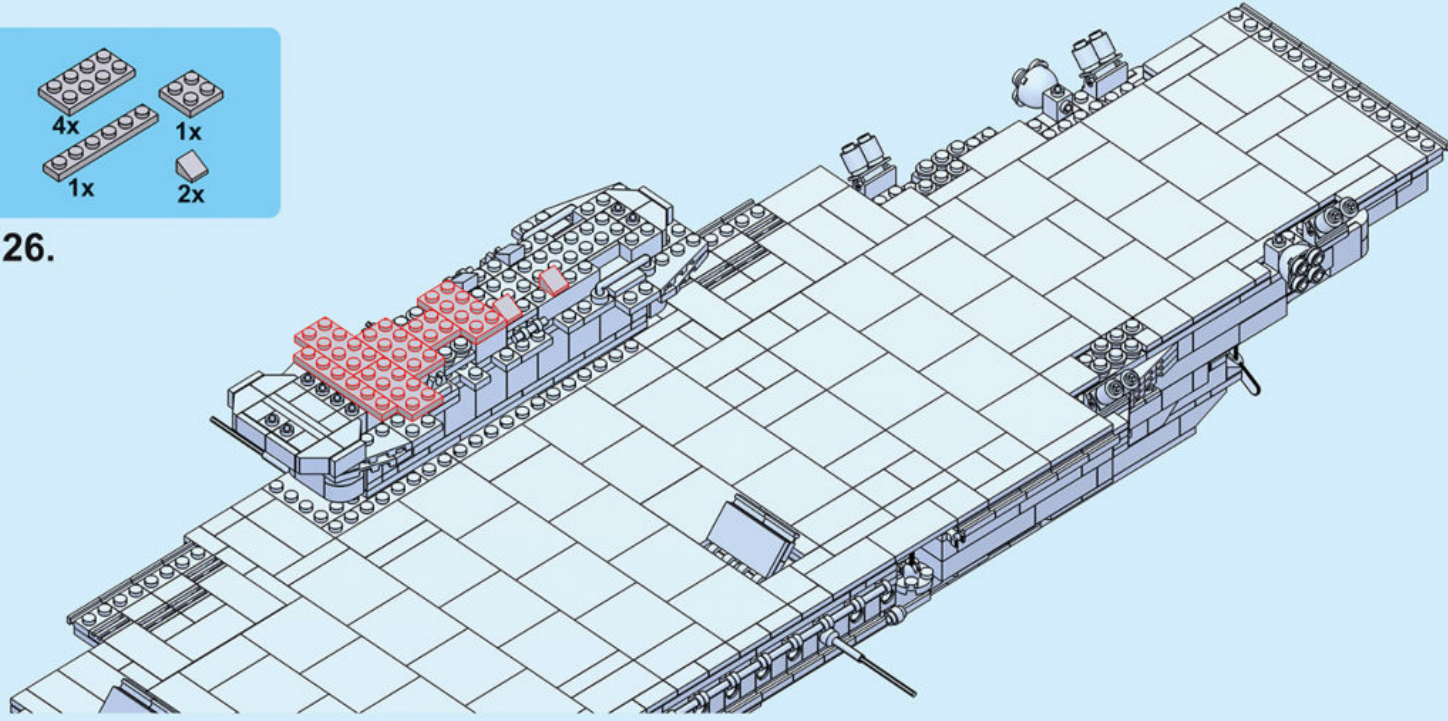

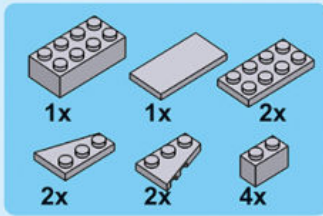

127.

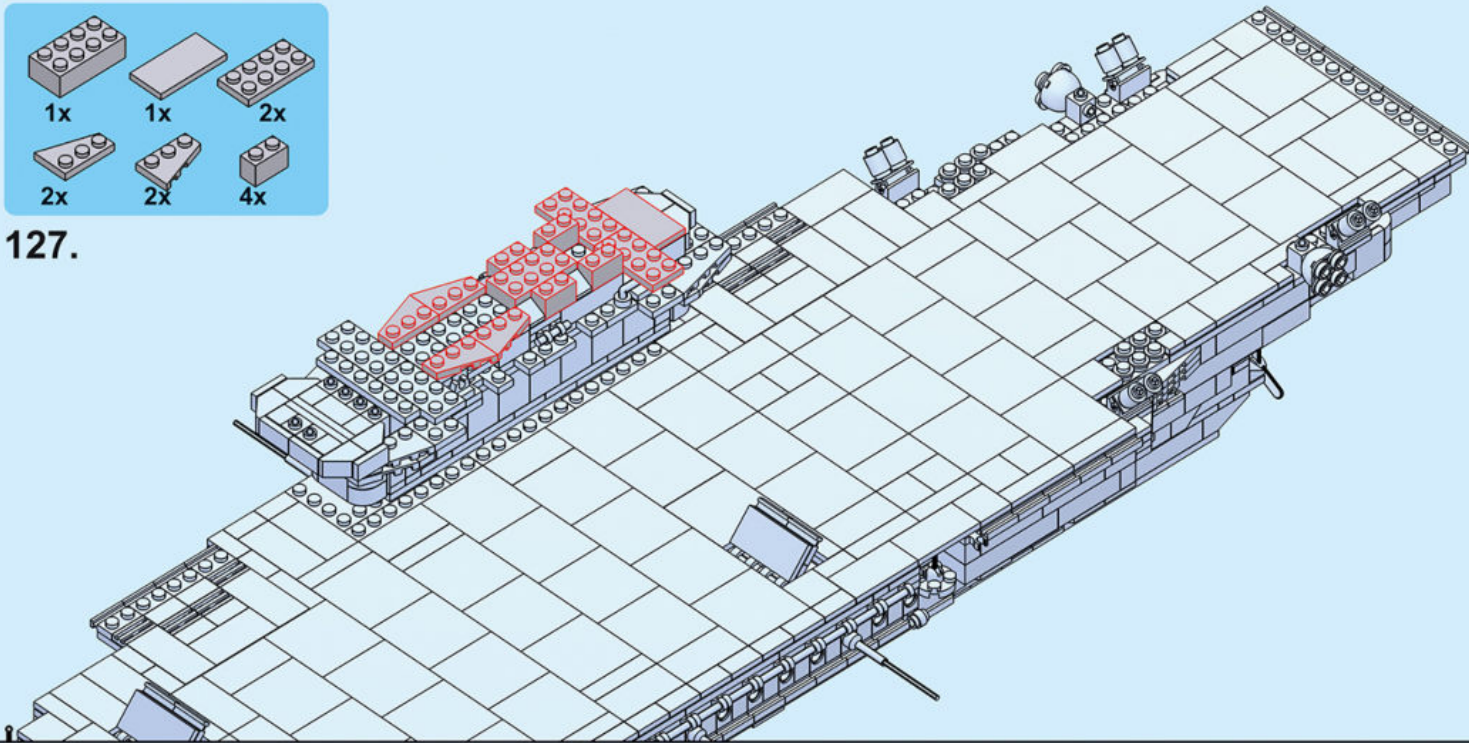

128.

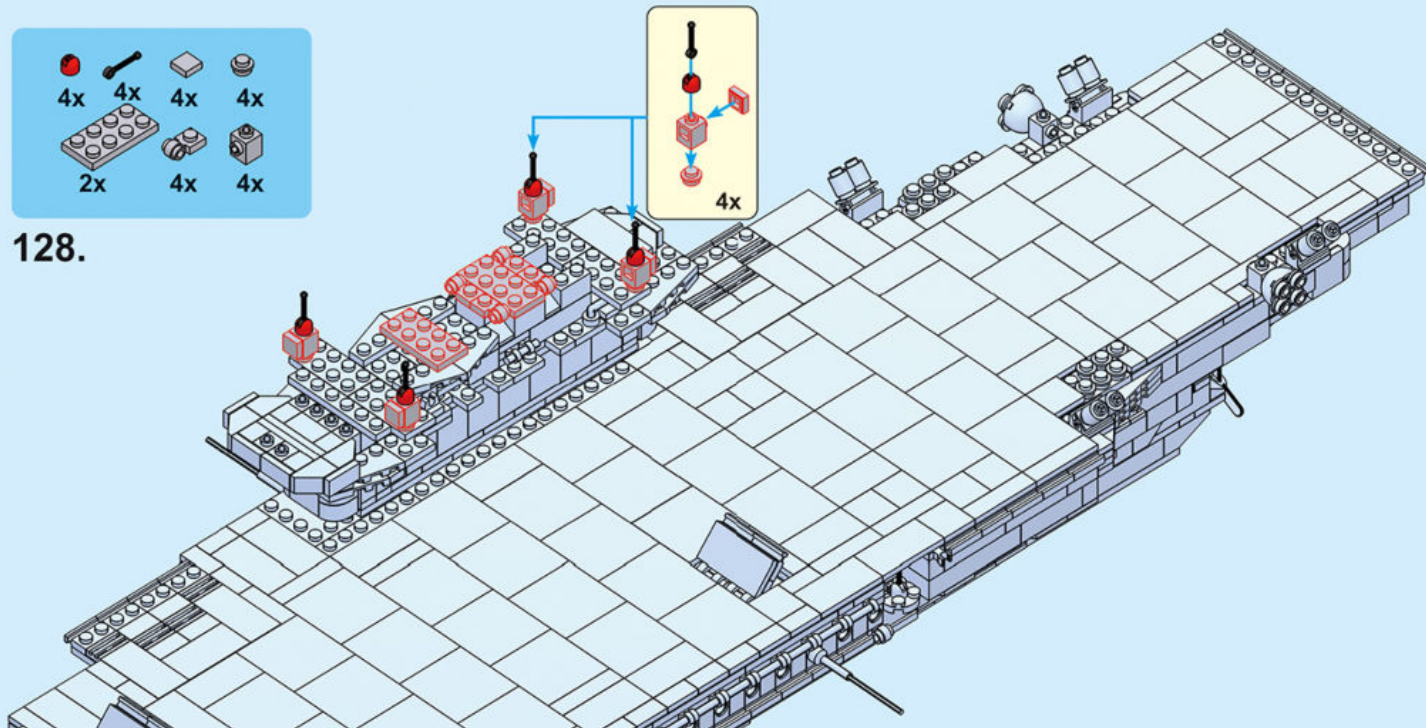

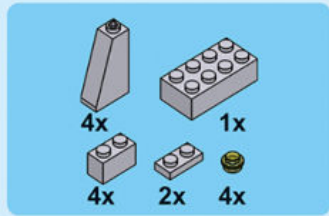

129.

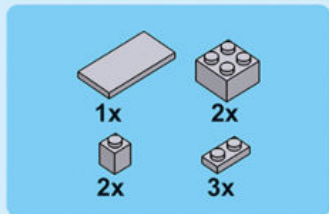
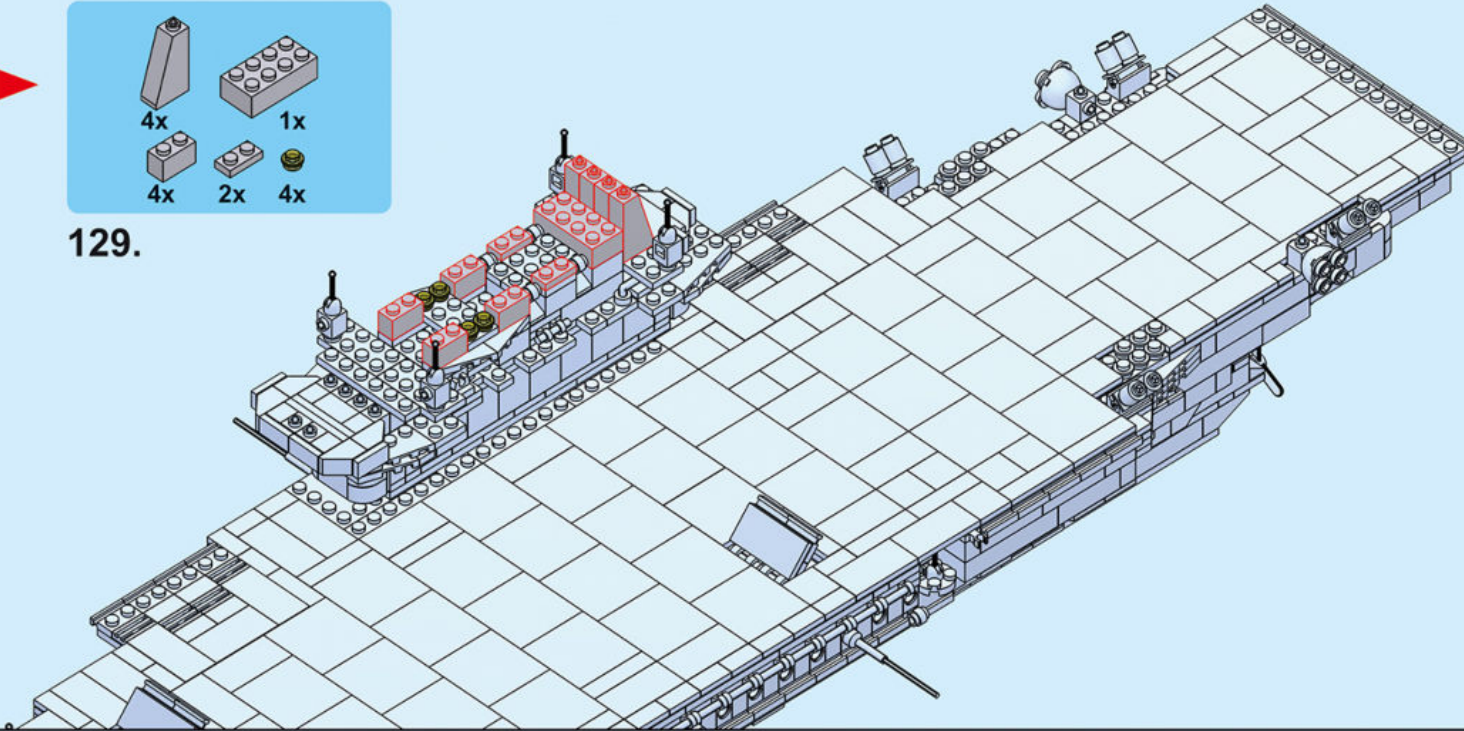

130.

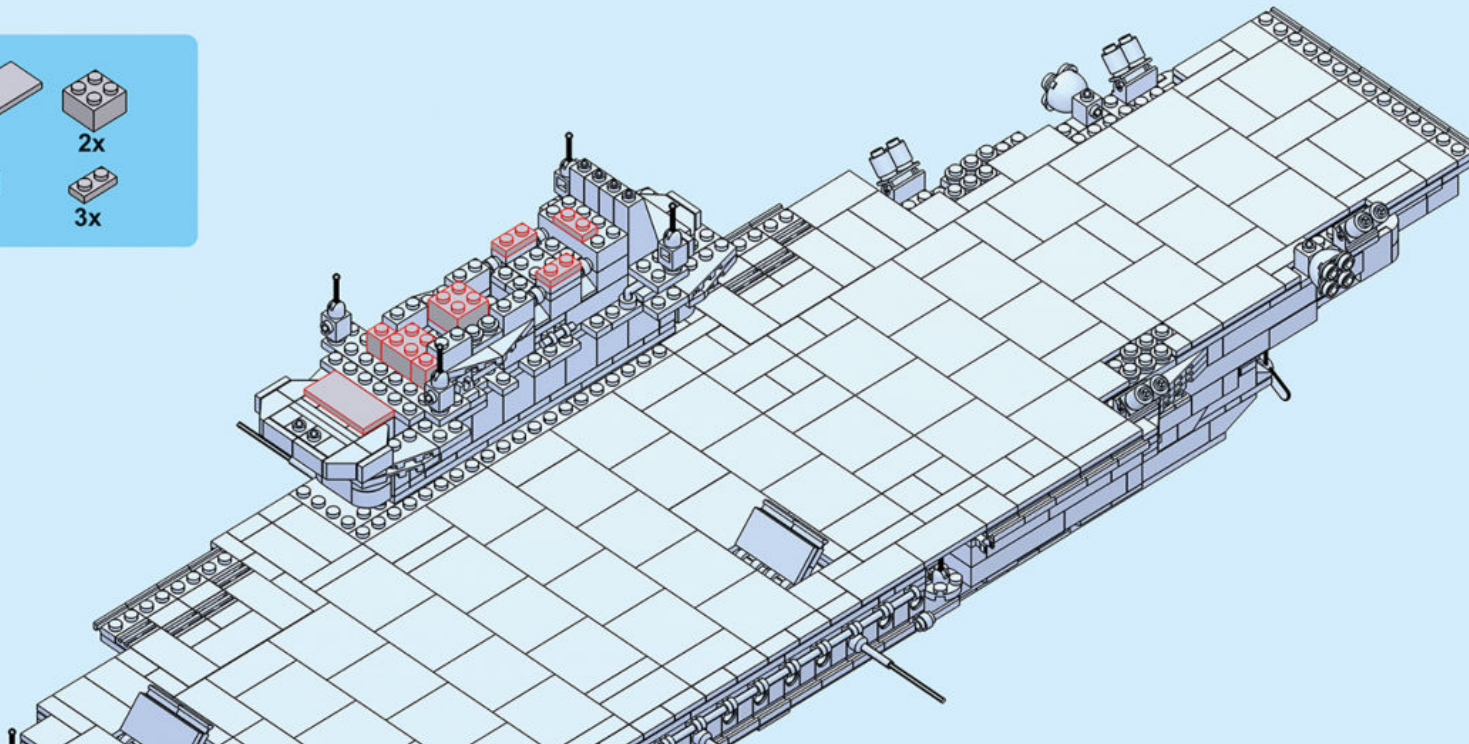

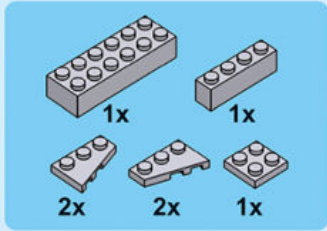

131.

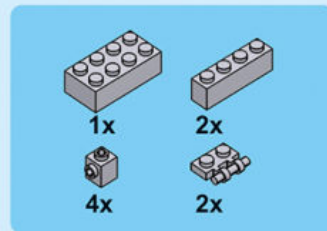
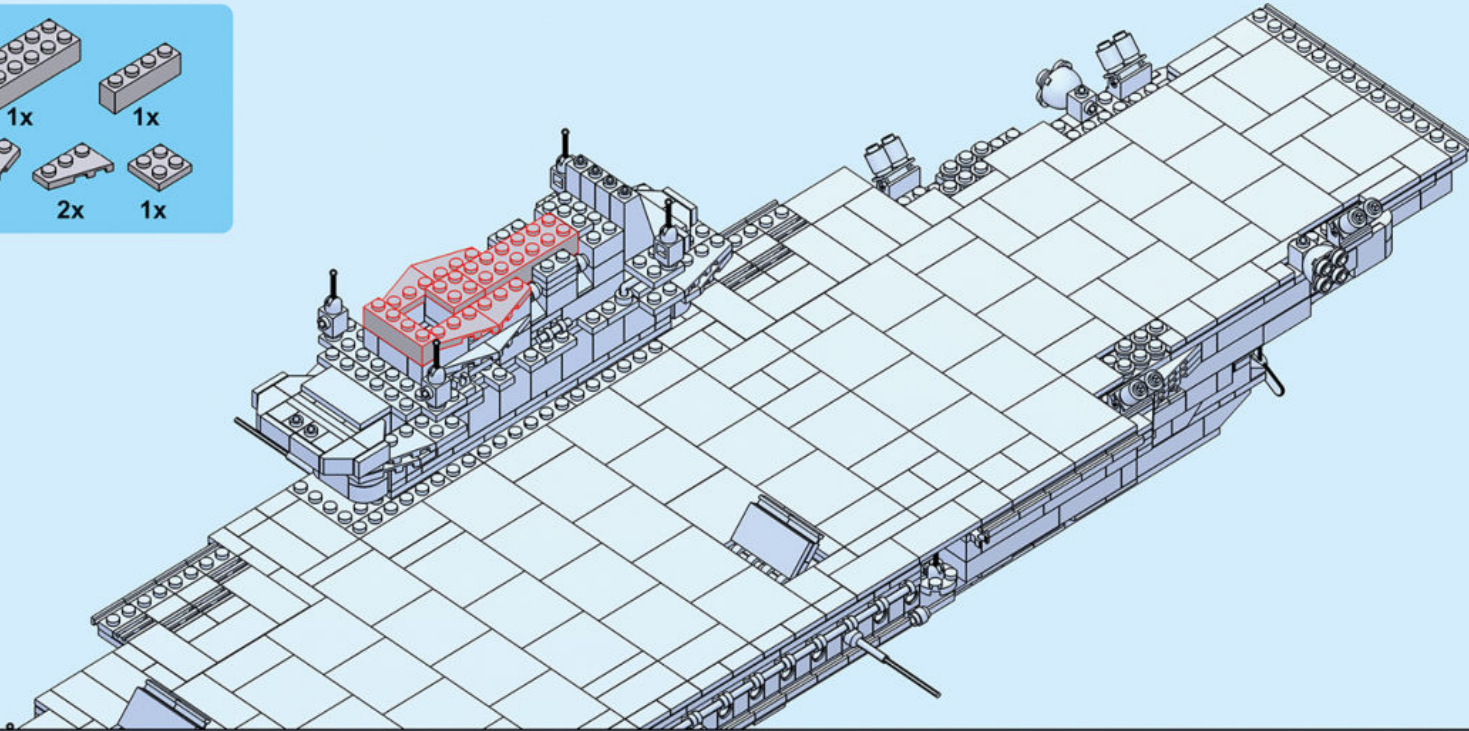

132.

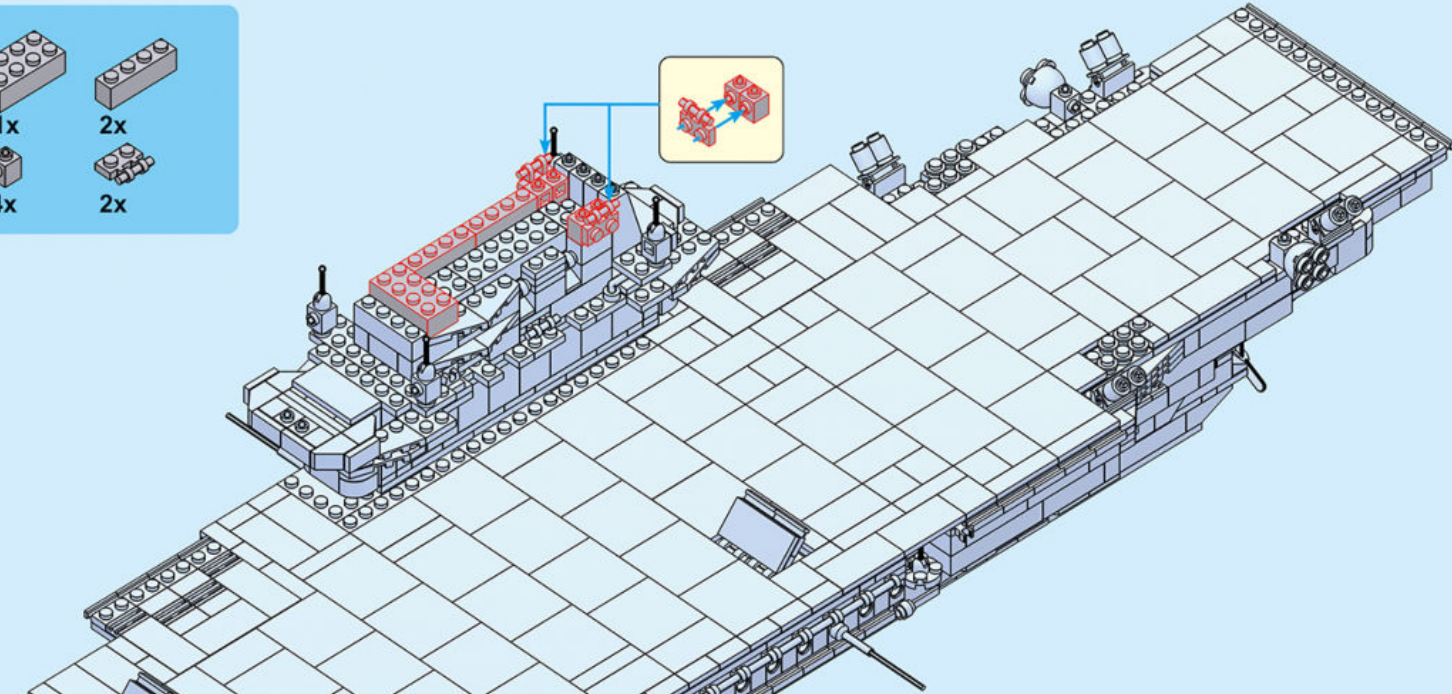



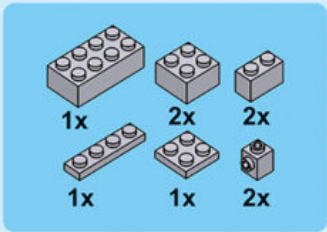

133.

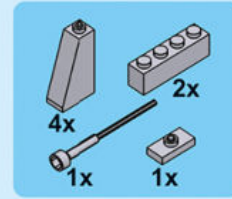
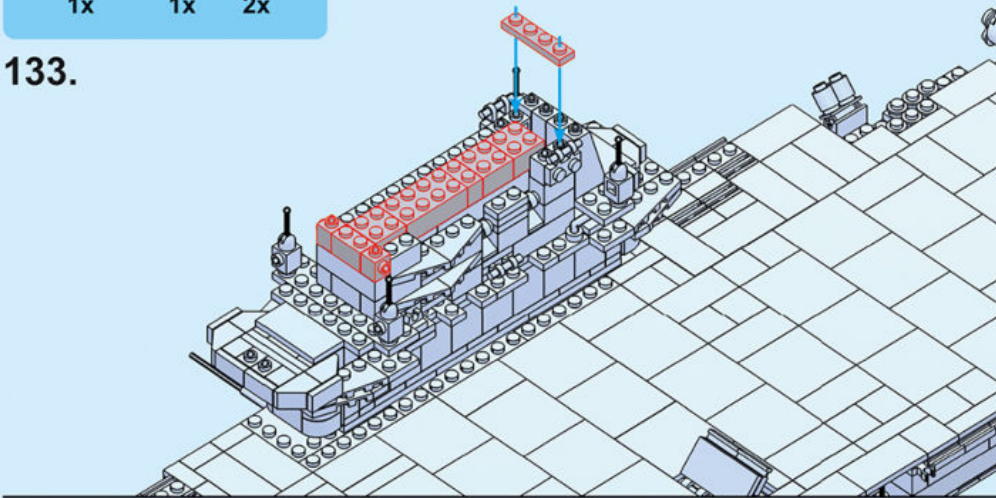

134.

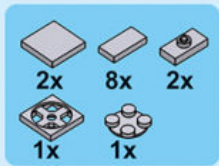
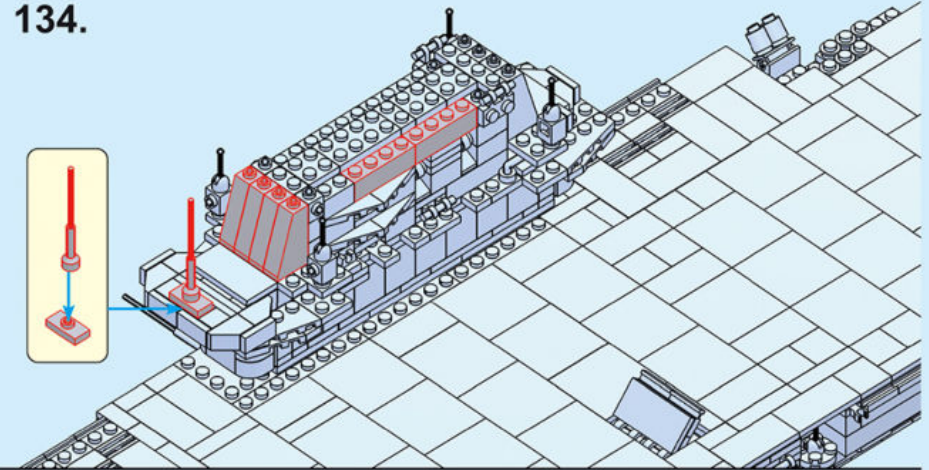

135.

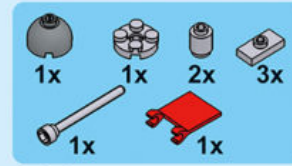
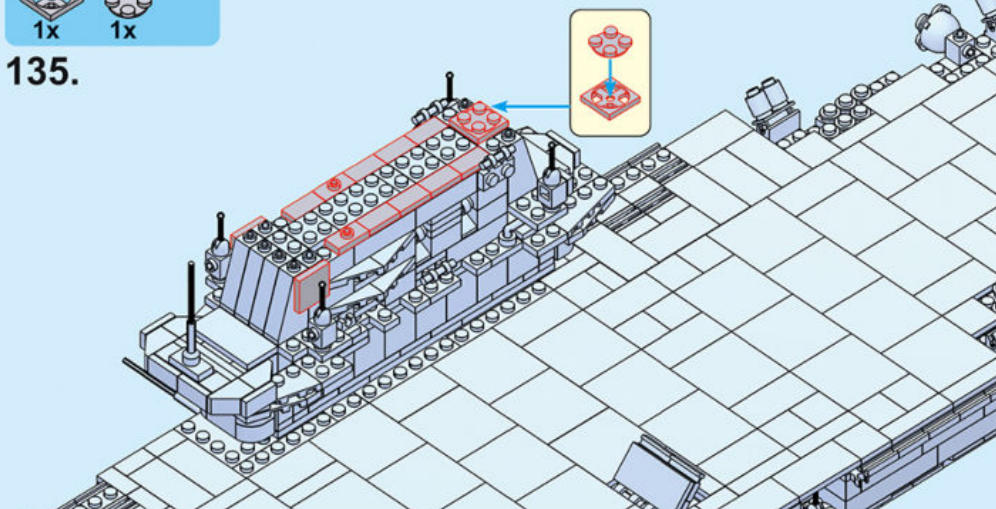

136.

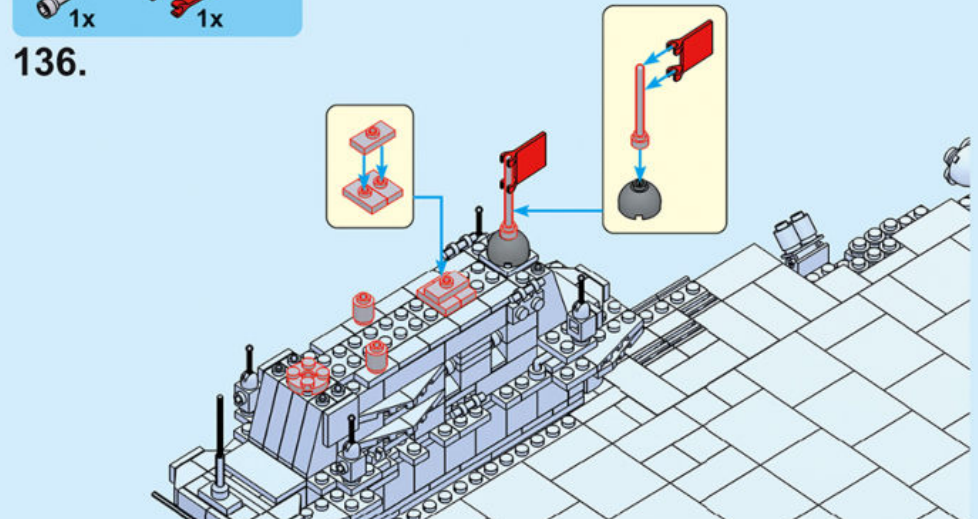

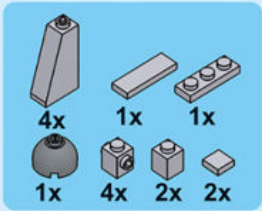

137.

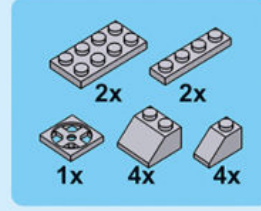
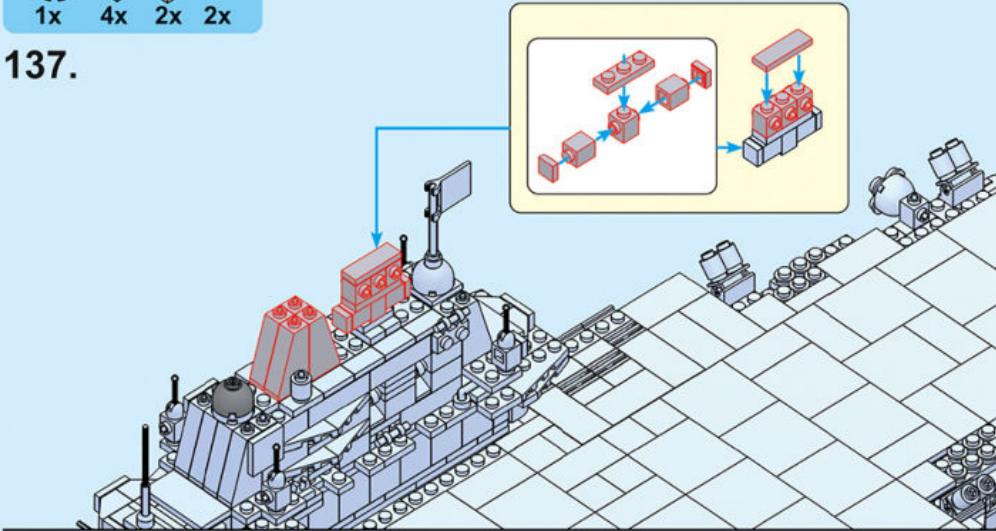

138.

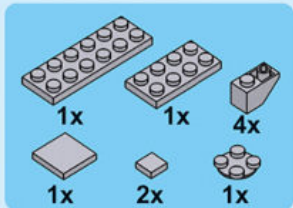
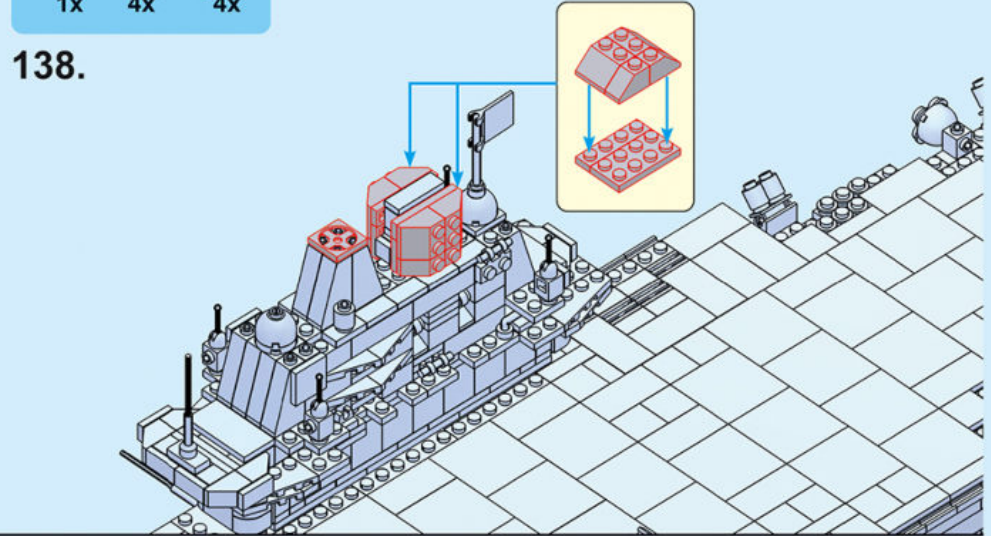

139.

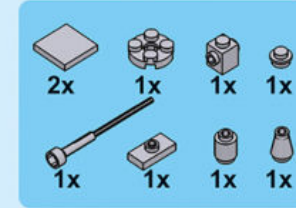
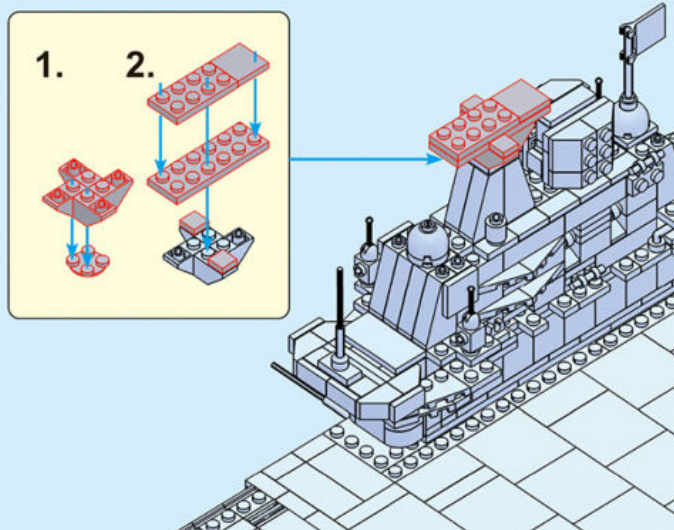

140.

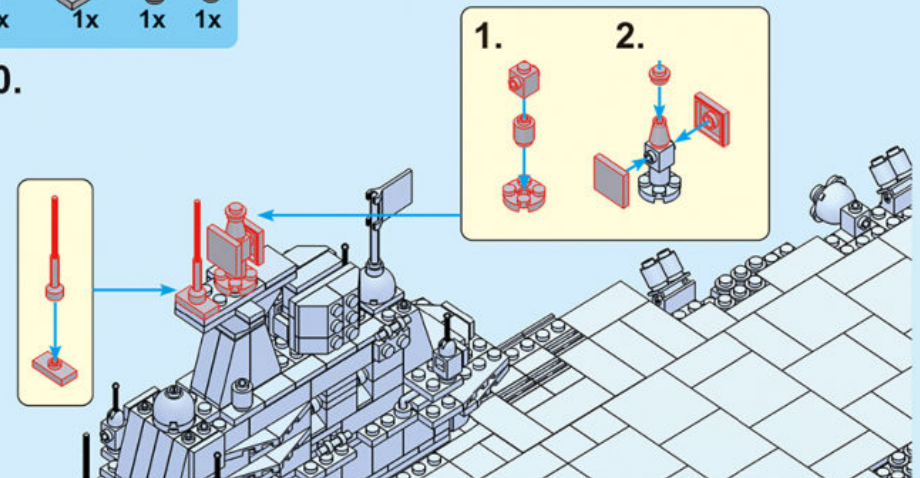

141.

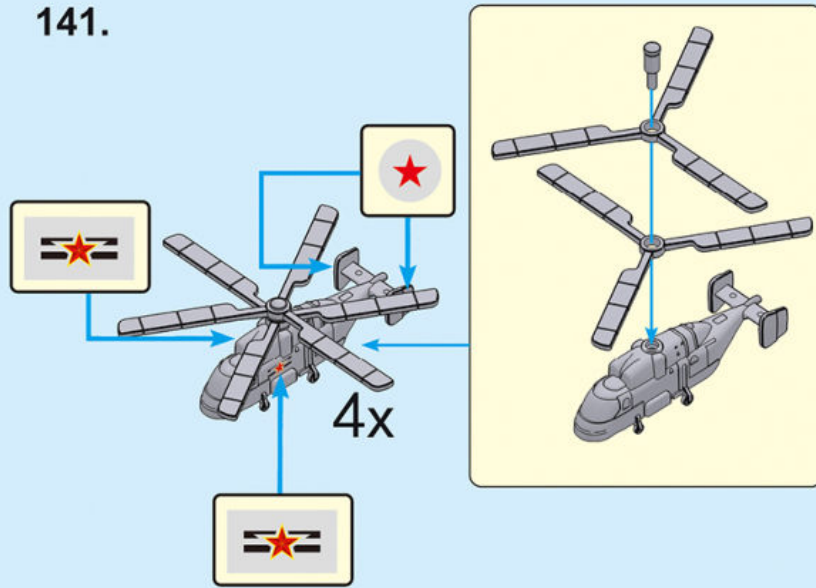

142.

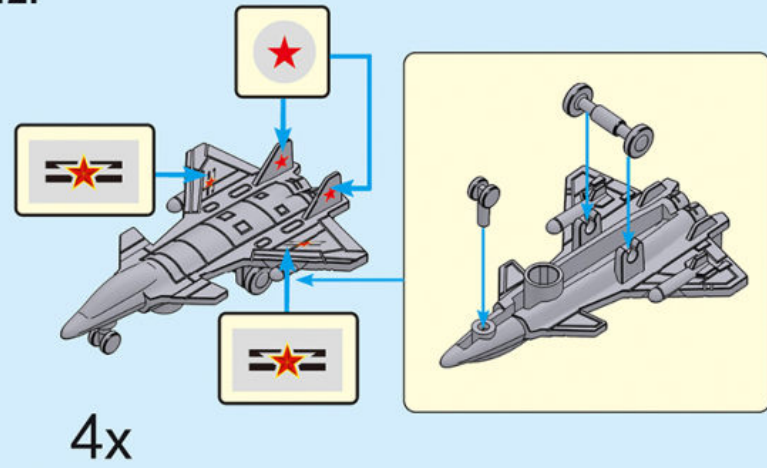

143.

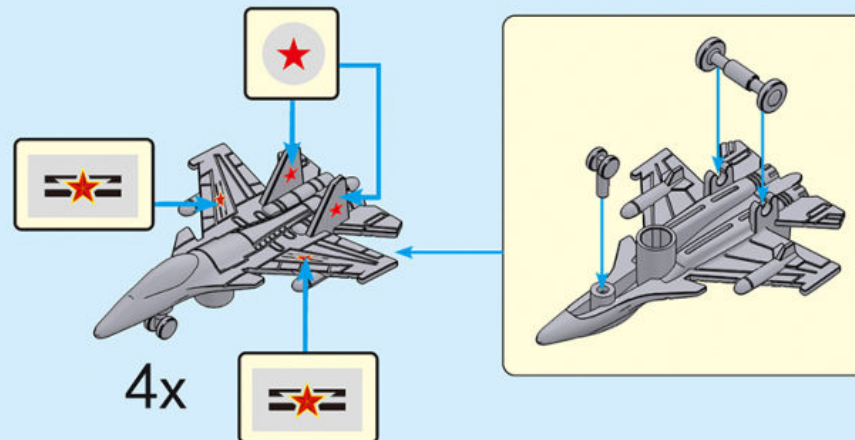





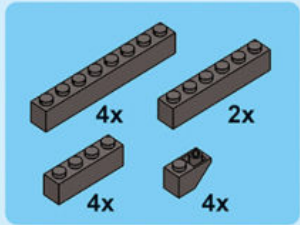

1.

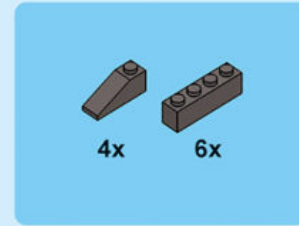
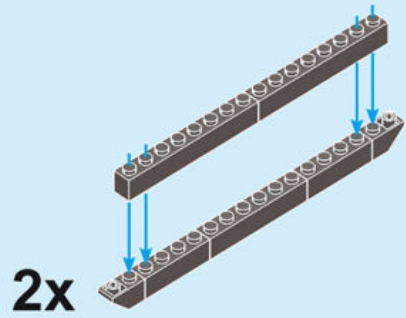

4.

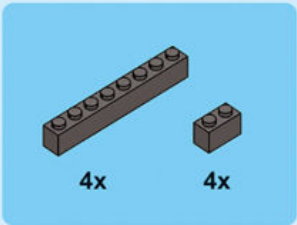
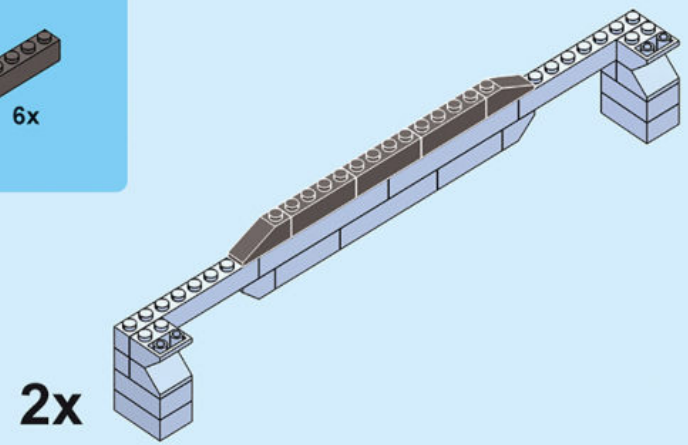

2.

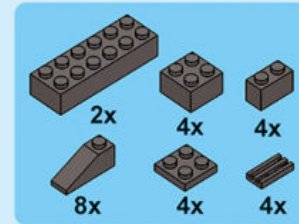
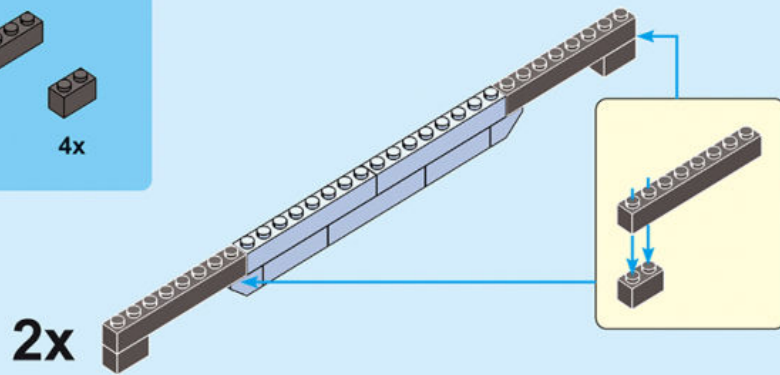

5.

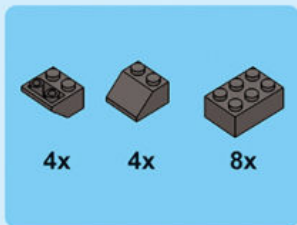
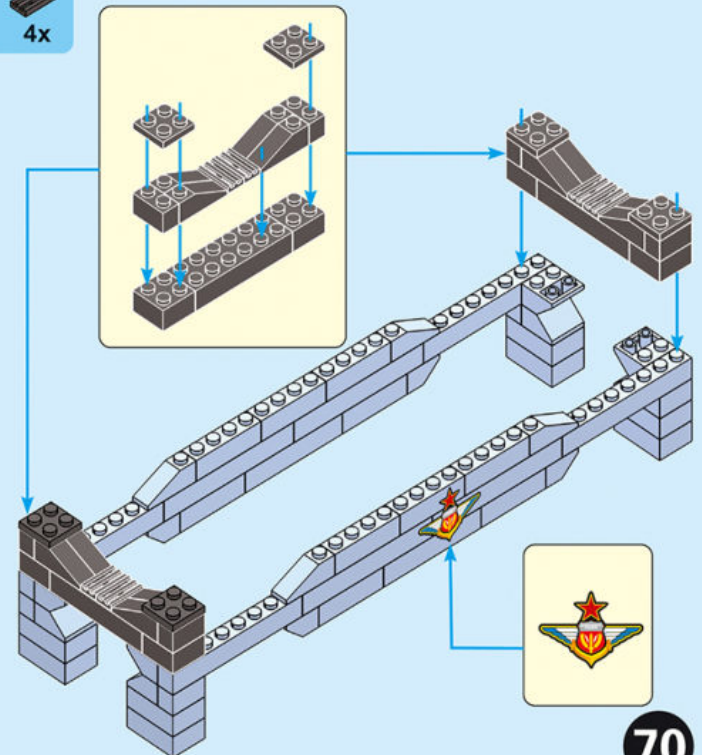

3.

