

1:558

405

AGE: 6+

AIRCRAFT CARRIER



COMMAND CENTER



AIRFIELD DECK



READY TO TAKE OFF



LANDING DECK



AIRCRAFT TAKE-OFF

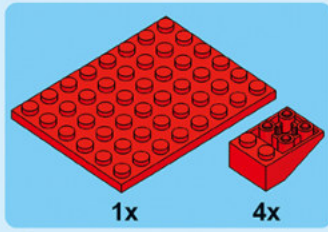

1.

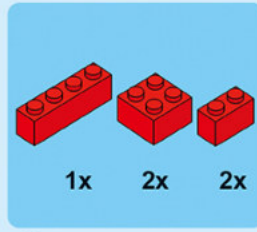
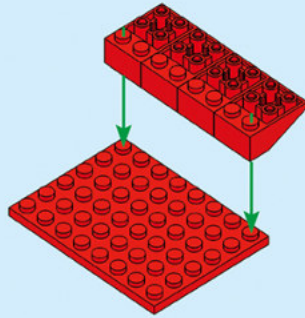

2.

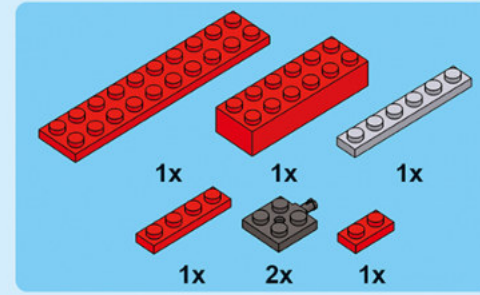
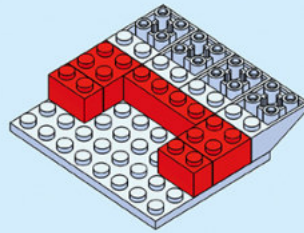

3.

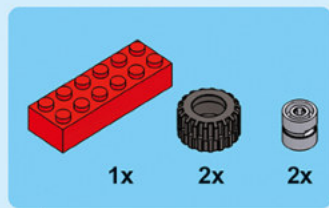
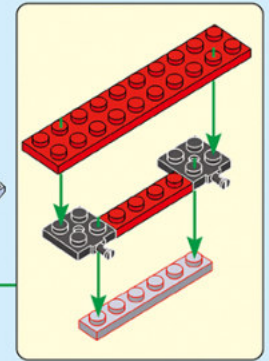
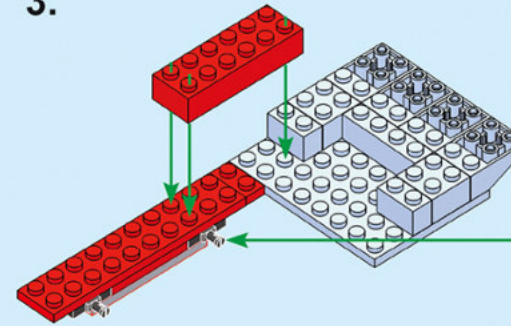

4.

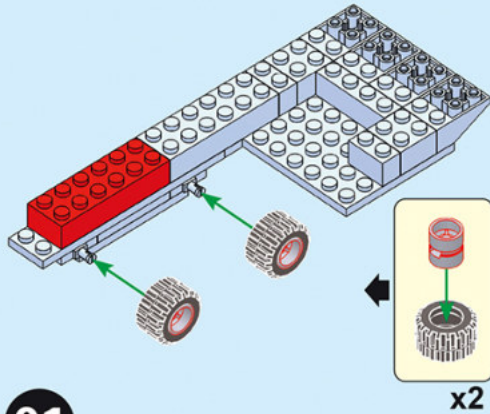

x2

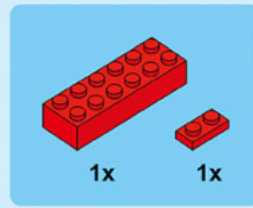

5.

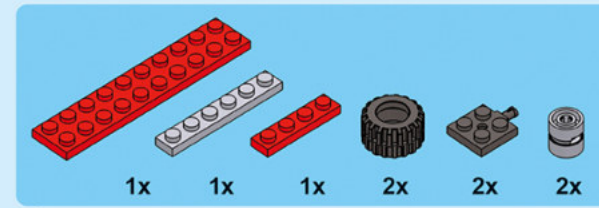
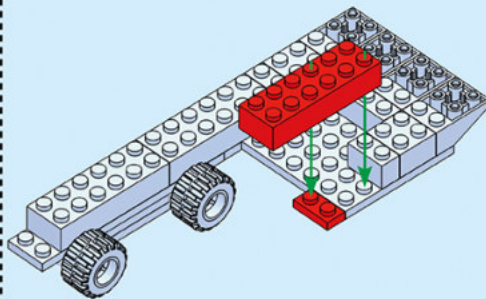

6.

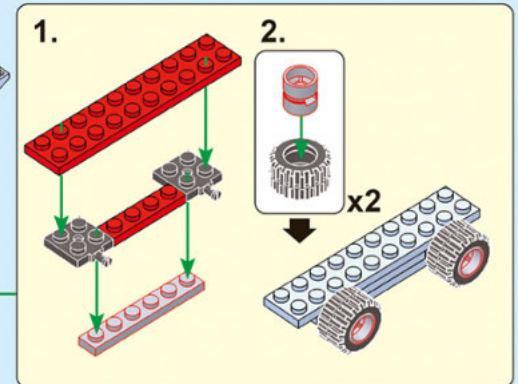
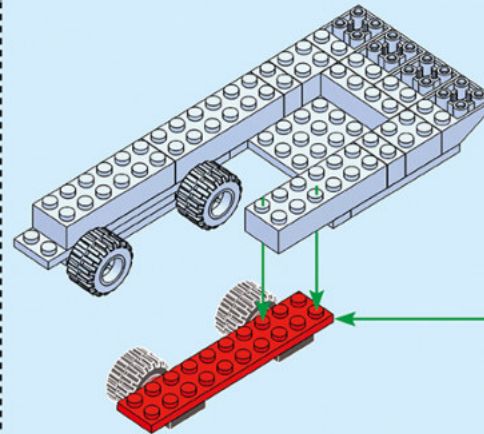

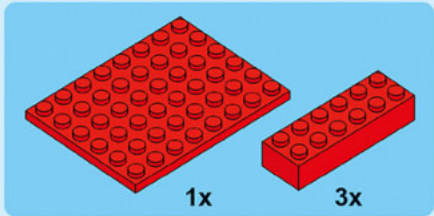

7.

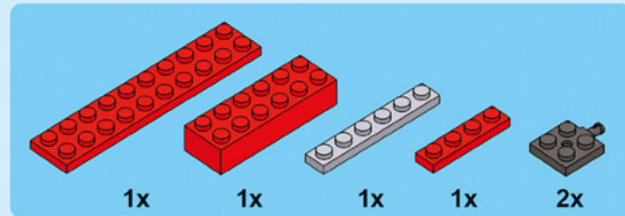
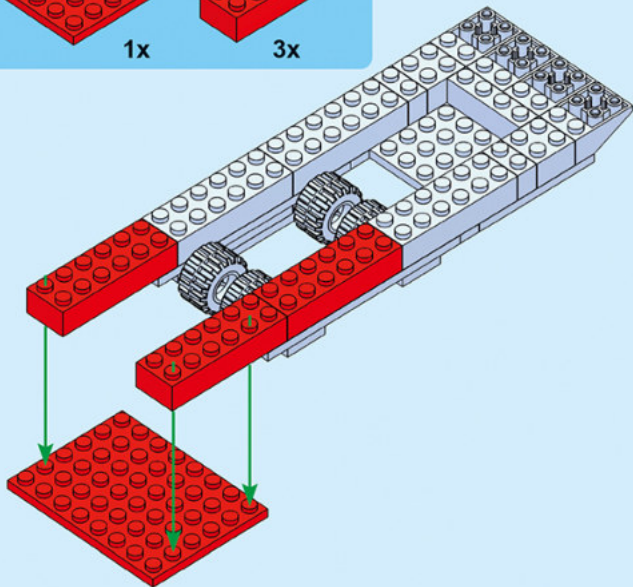

8.

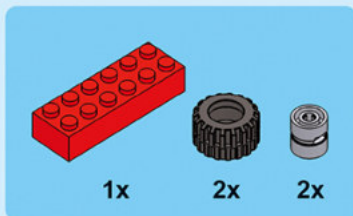
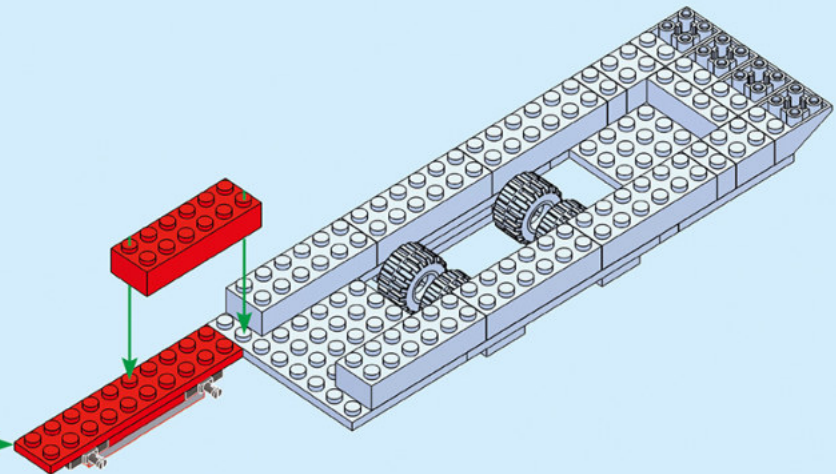
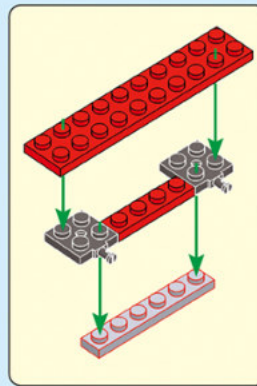

9.

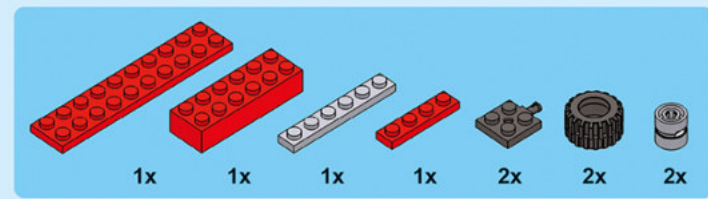
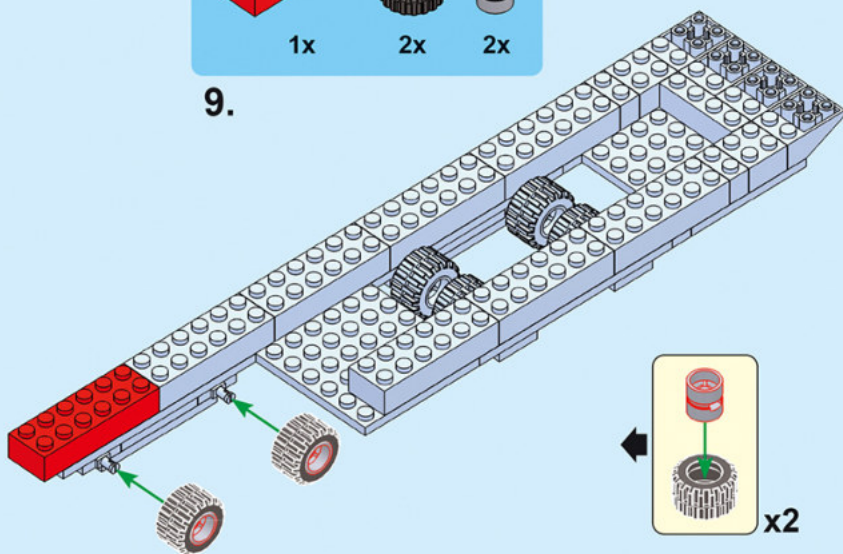

10.

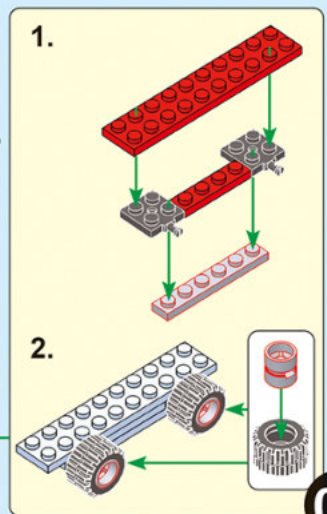
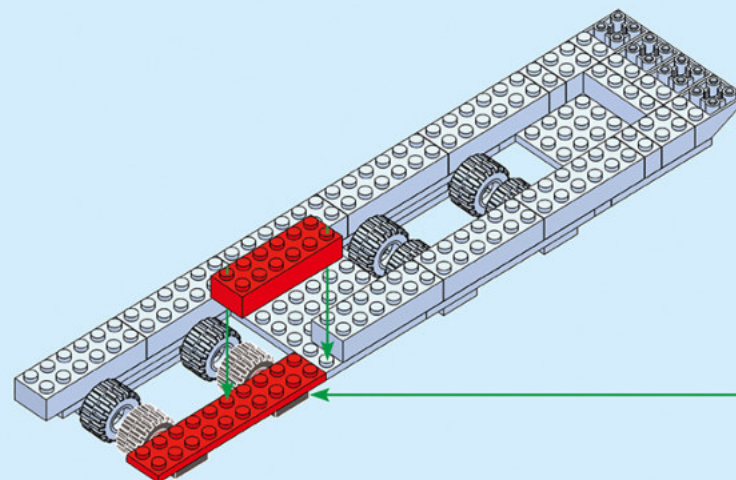

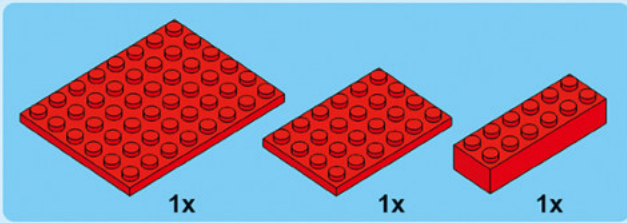

11.

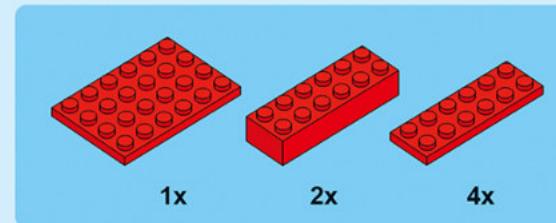
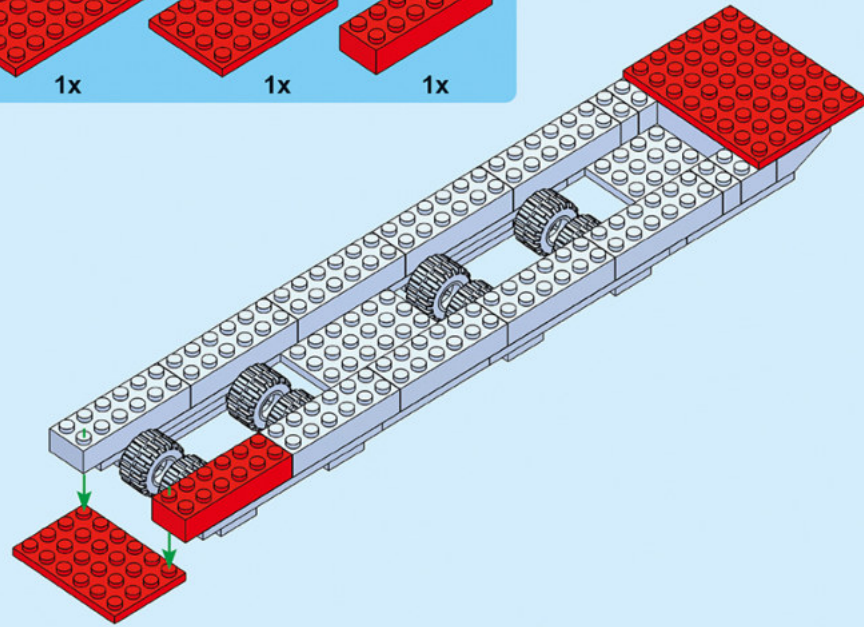

12.

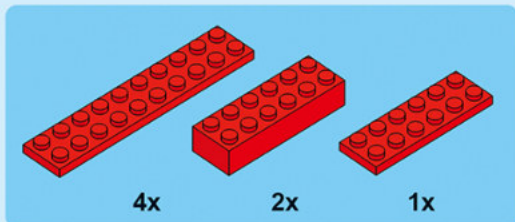
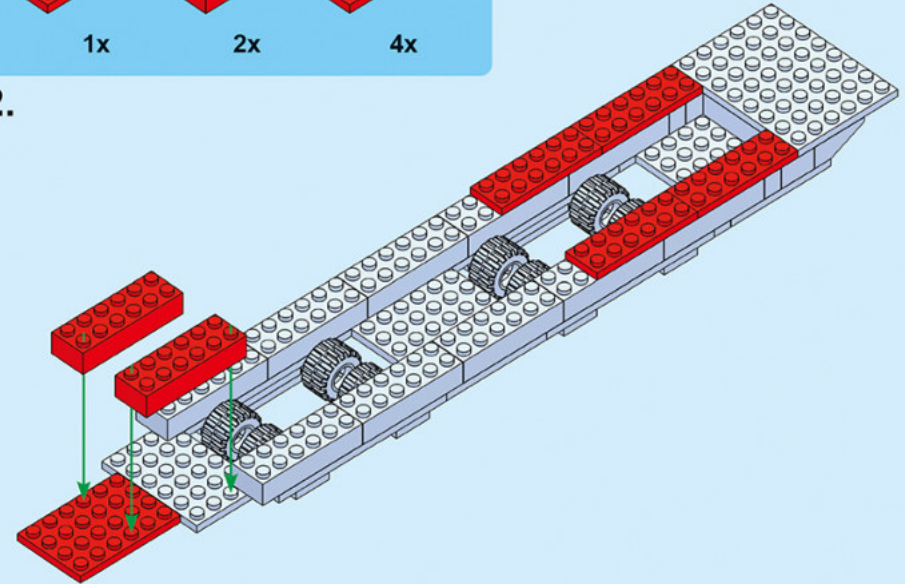

13.

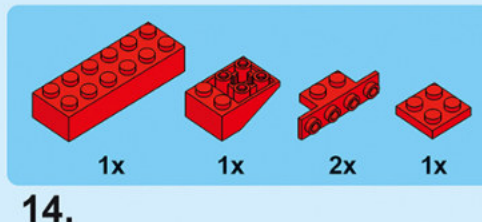
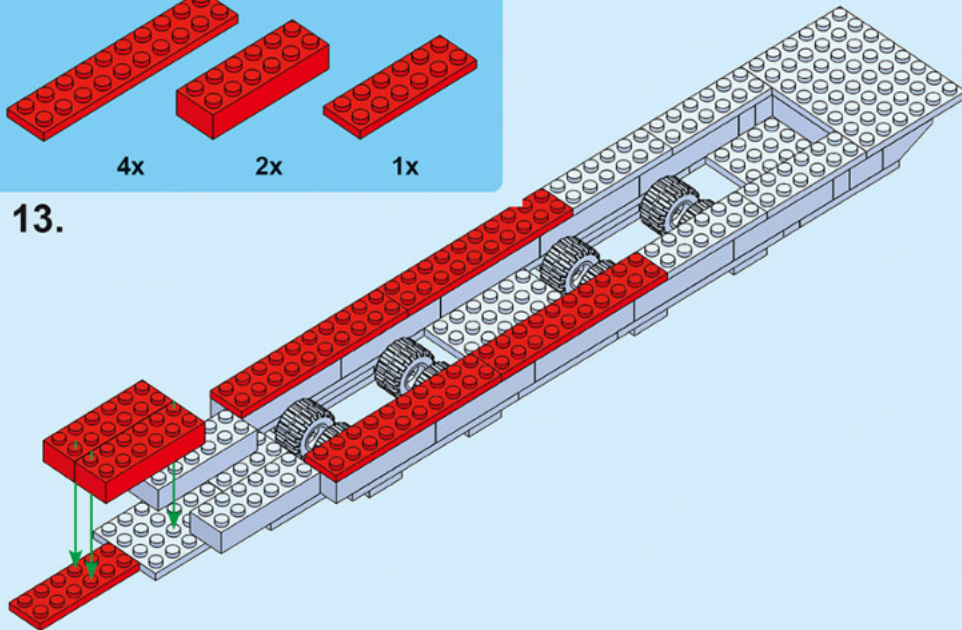

14.

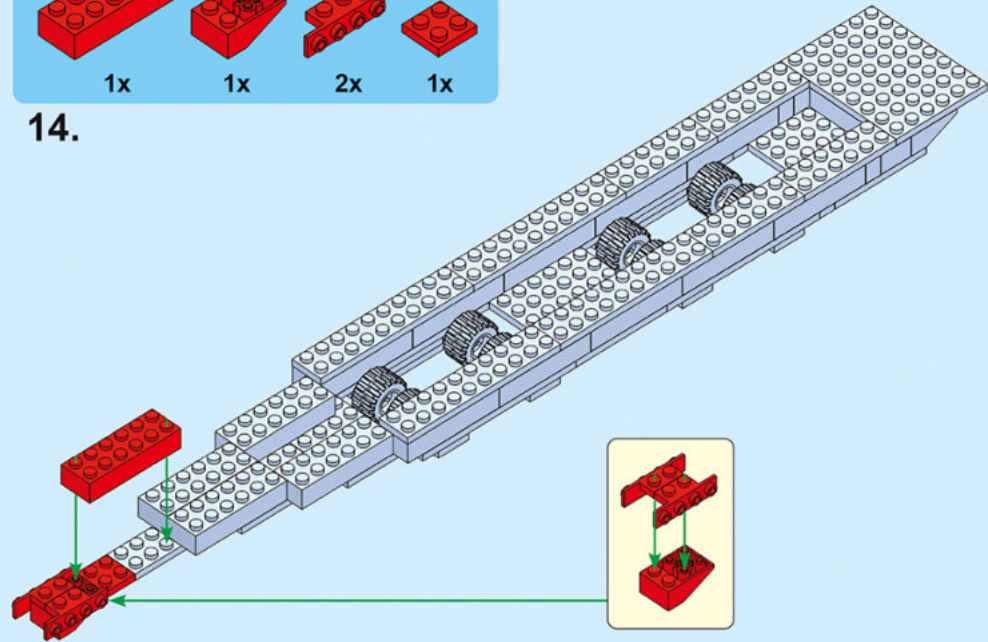

03

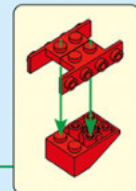

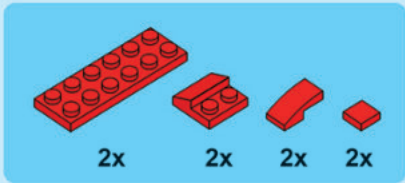

15.

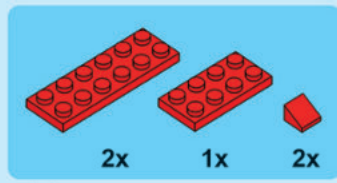
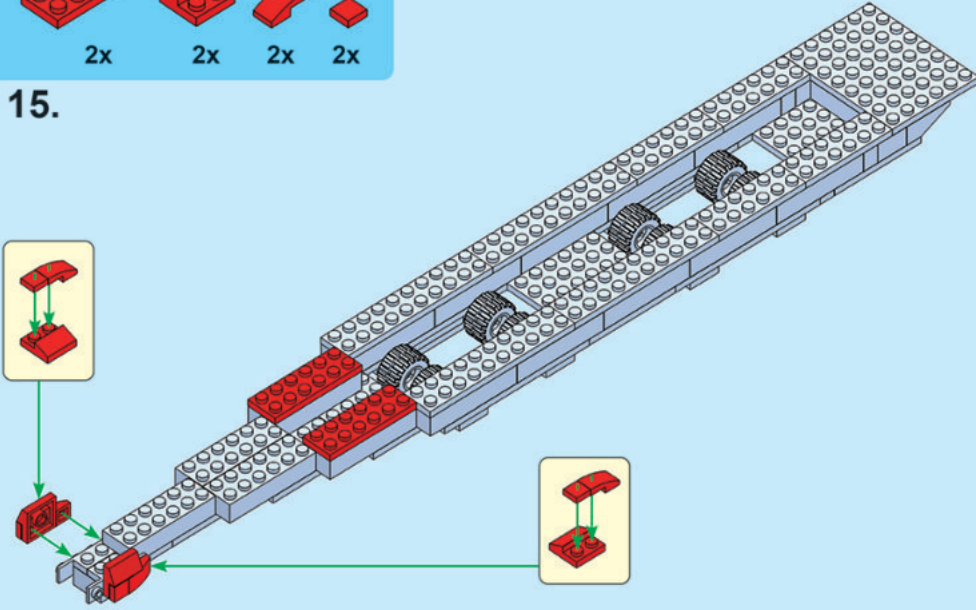
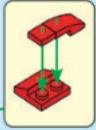
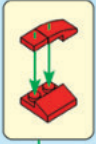

16.

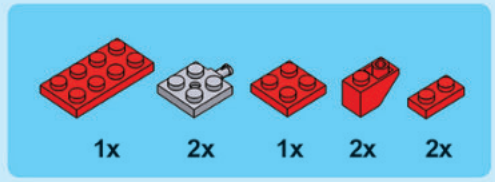
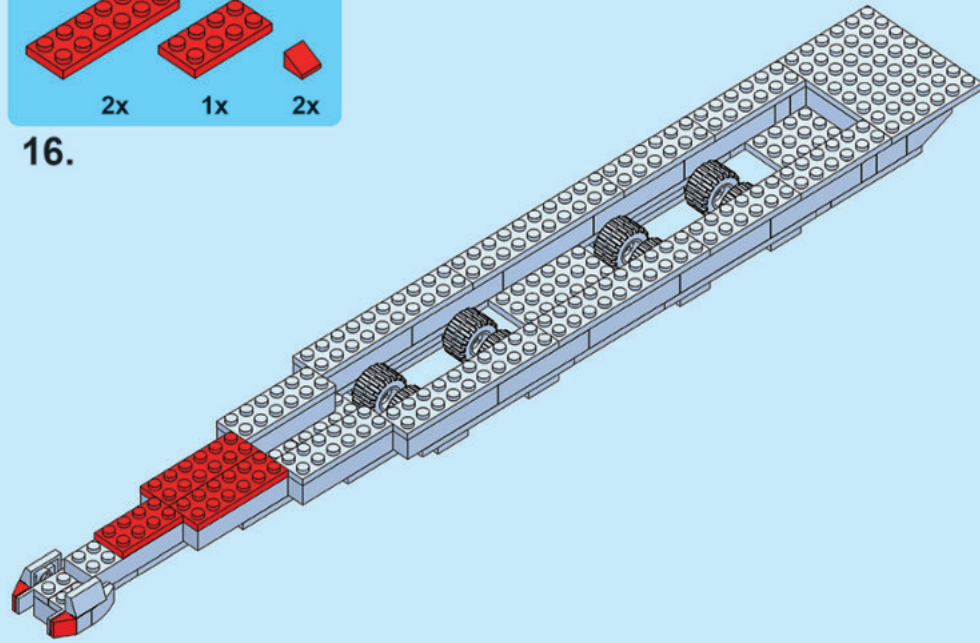

17.

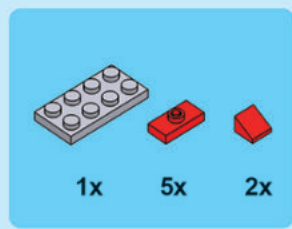
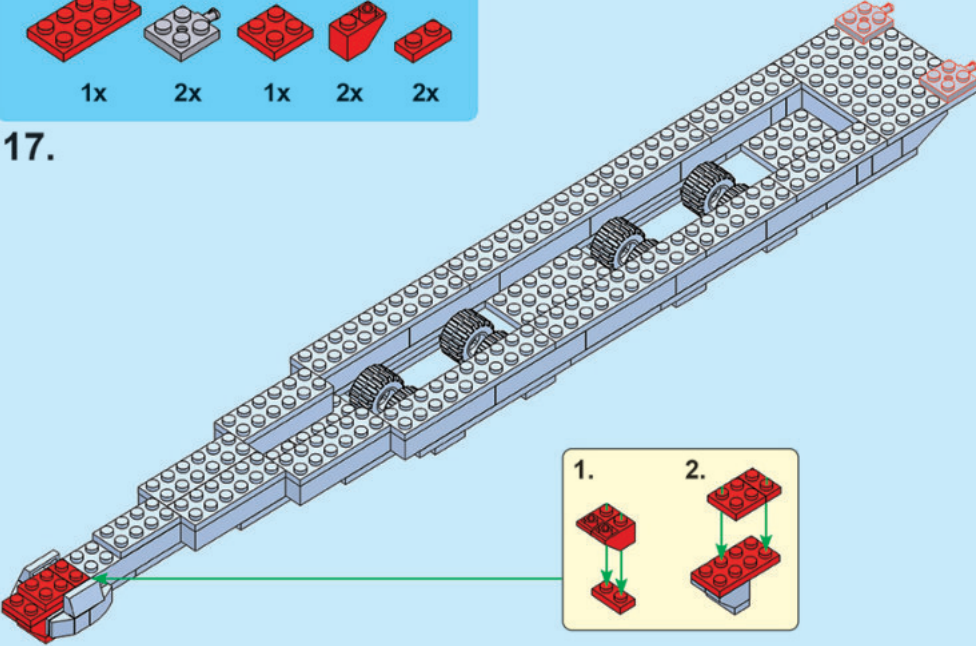
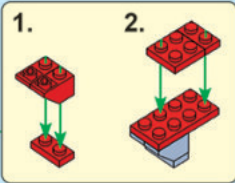

18.

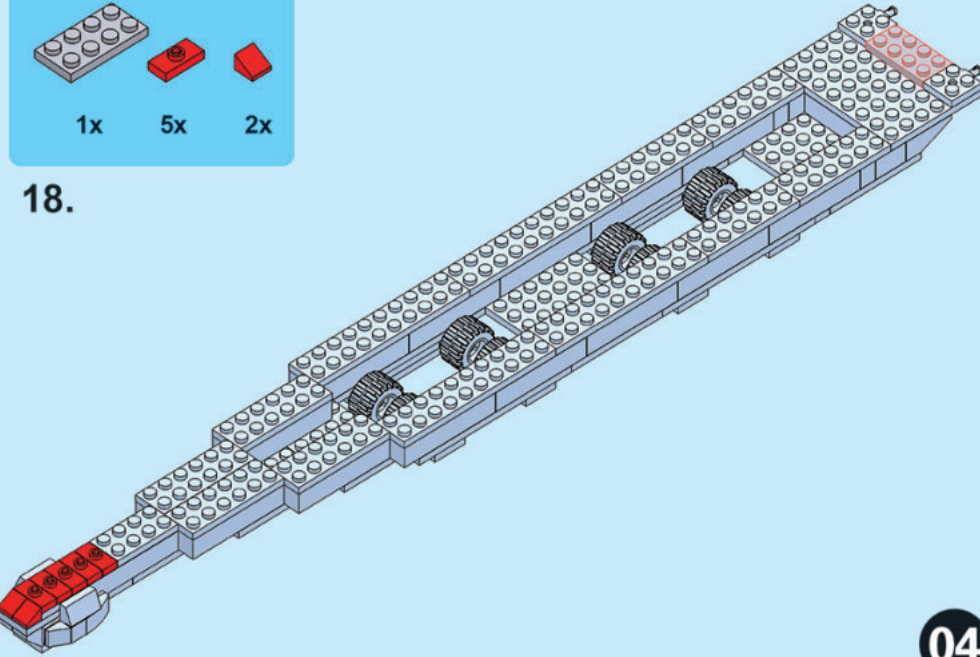

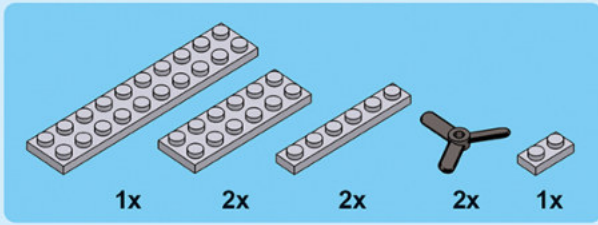

19.

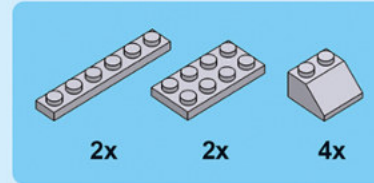
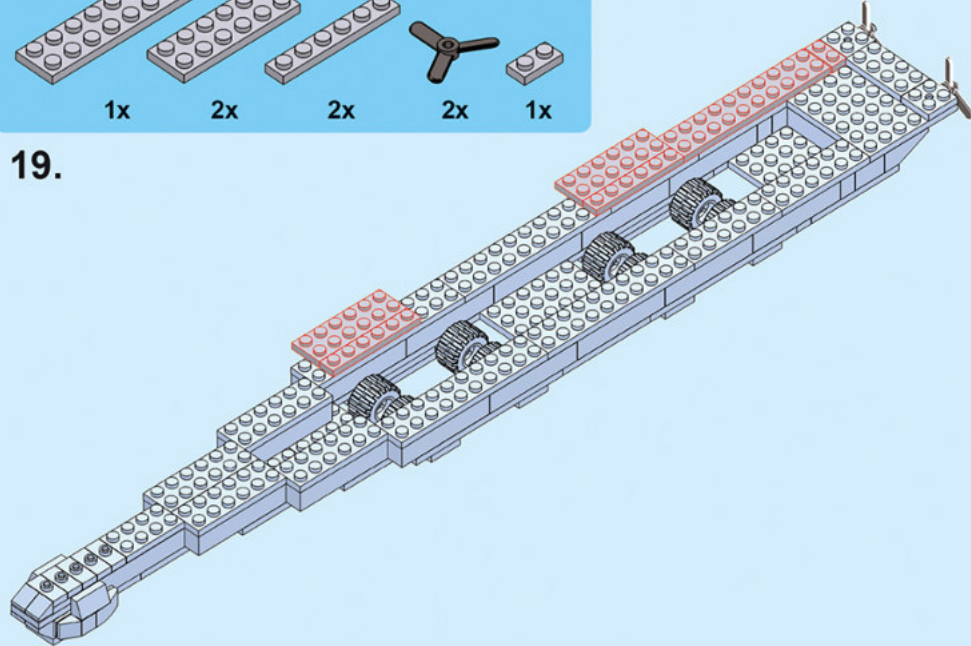

20.

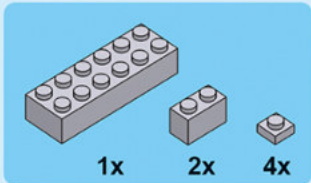
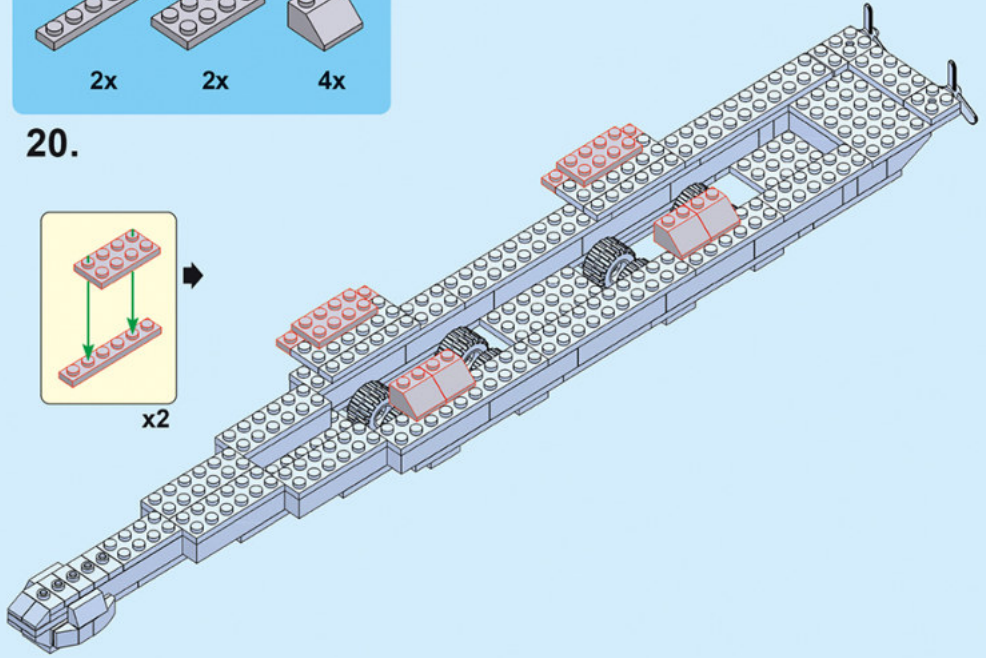

21.

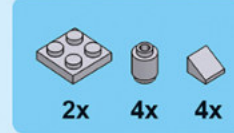
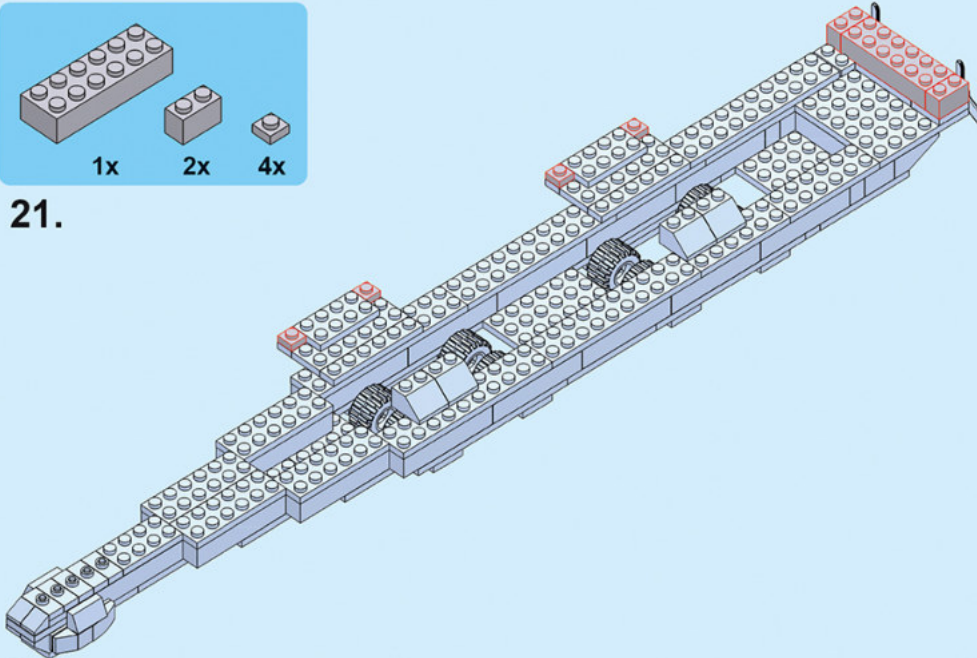

22.

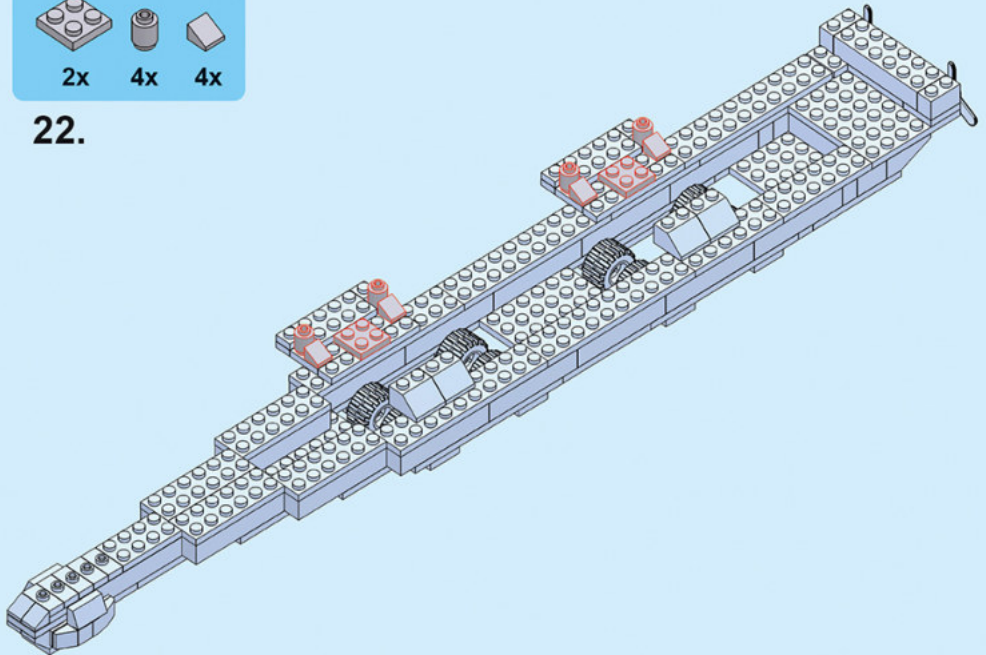

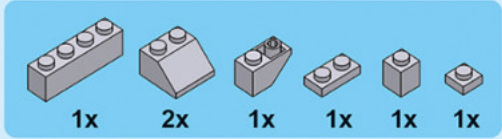

23.

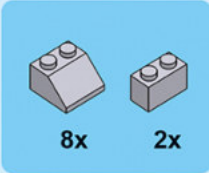
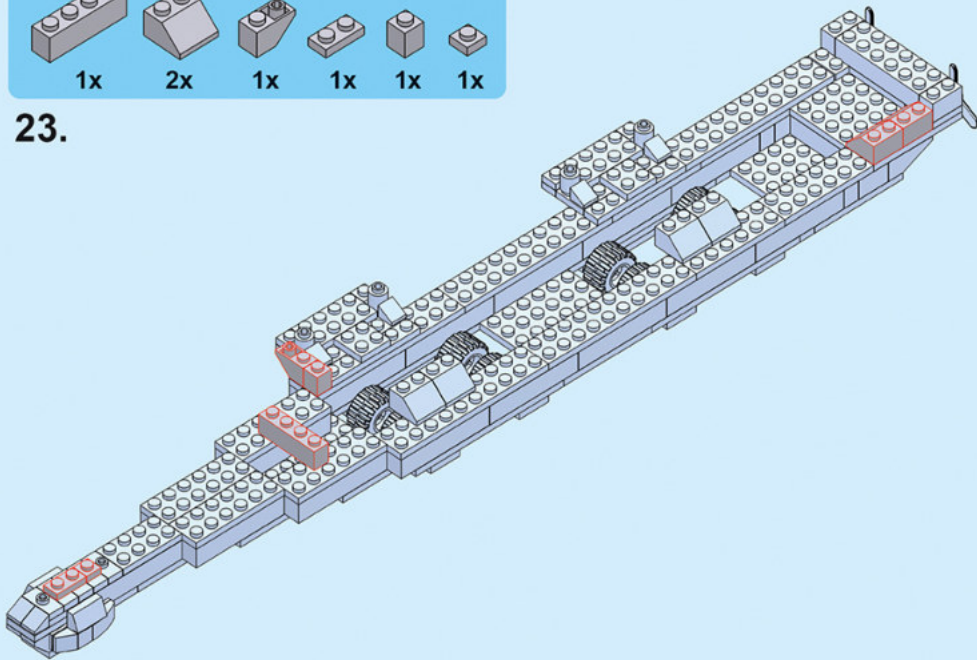

24.

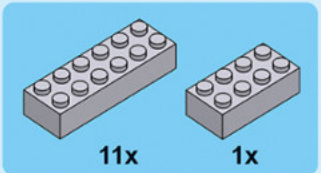
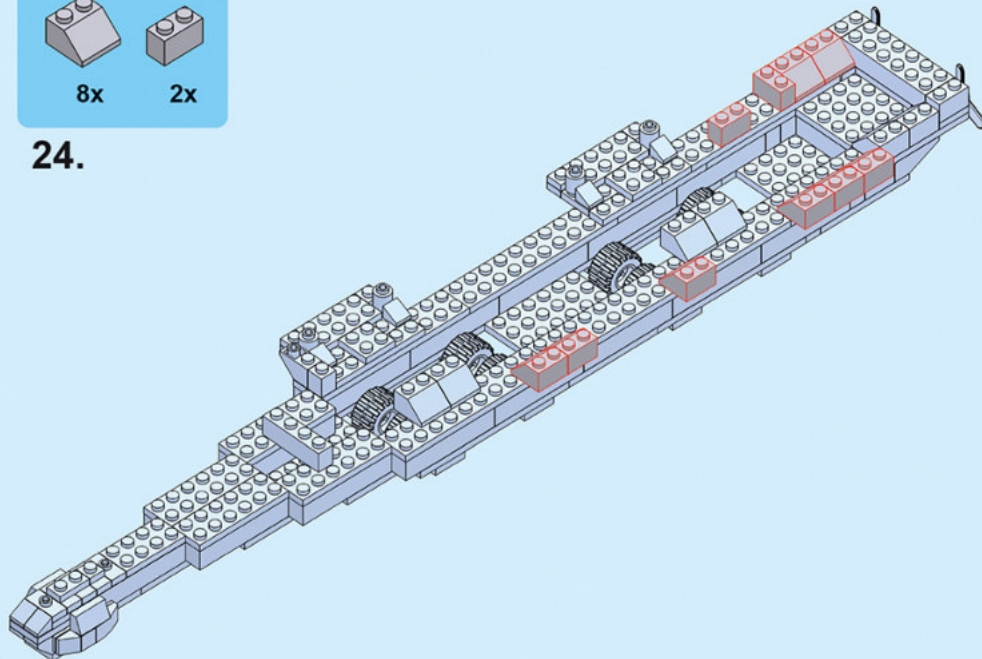

25.

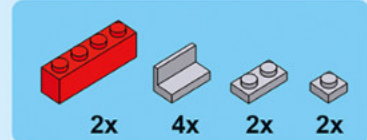
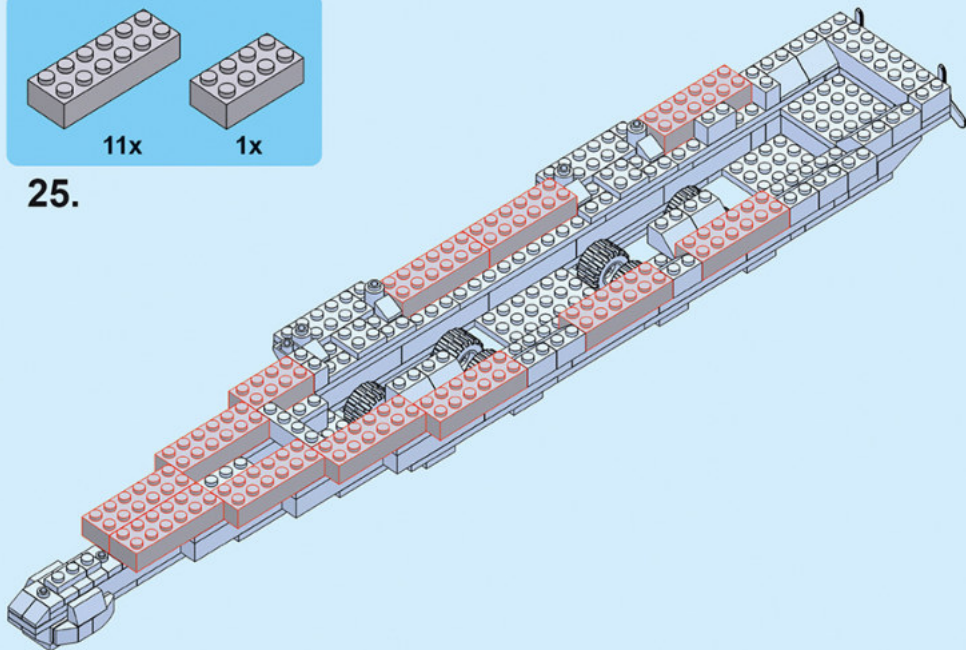

26.

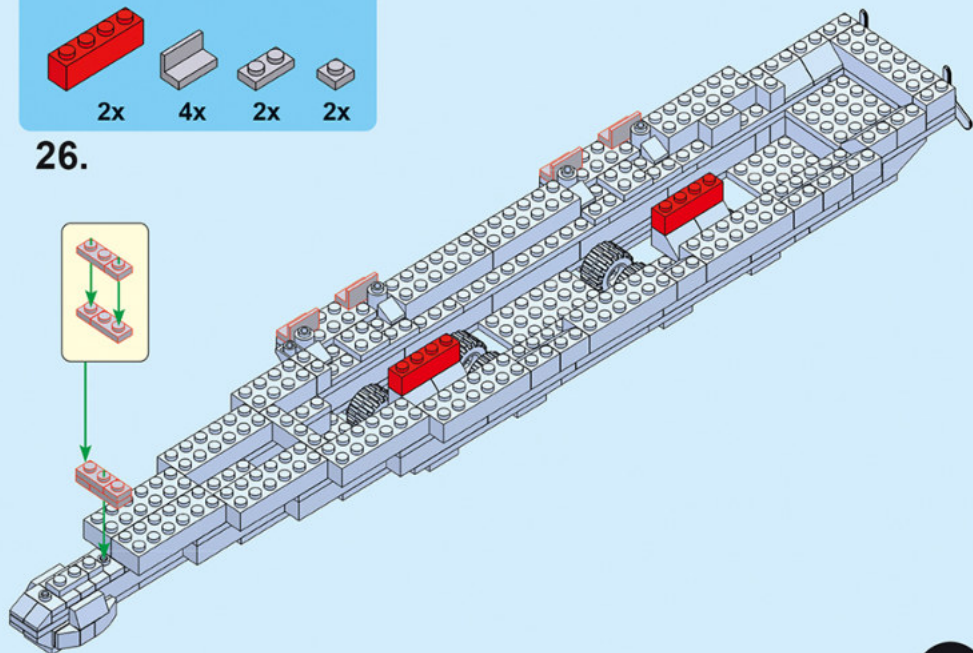

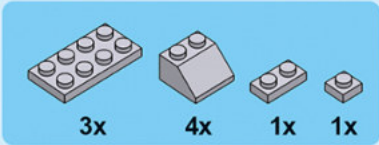

27.

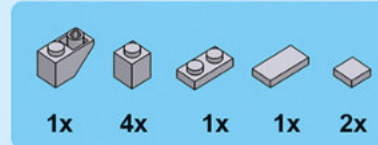
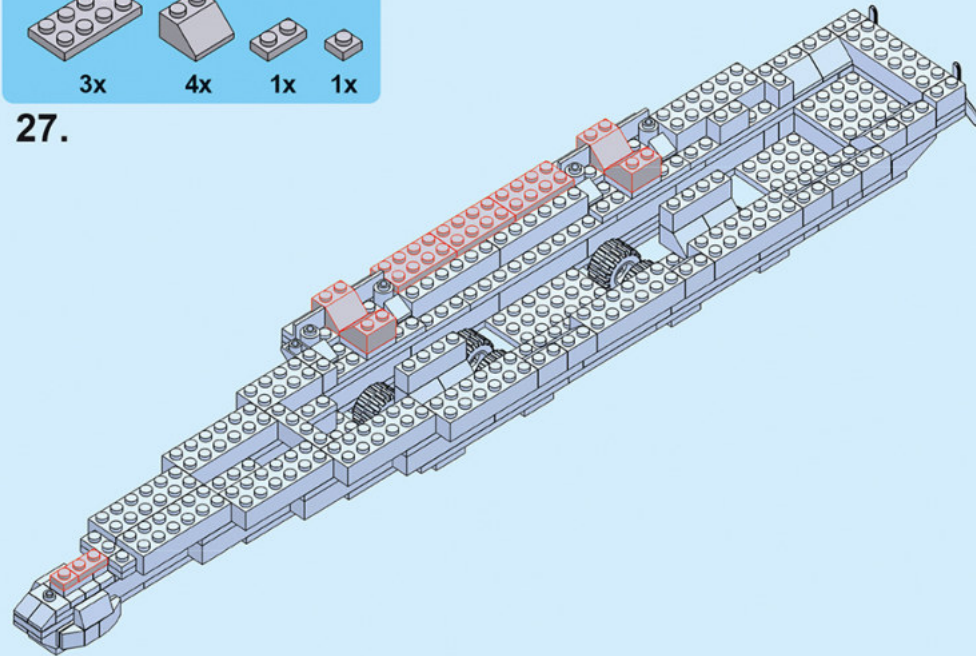

28.

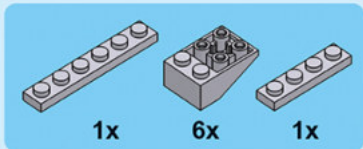
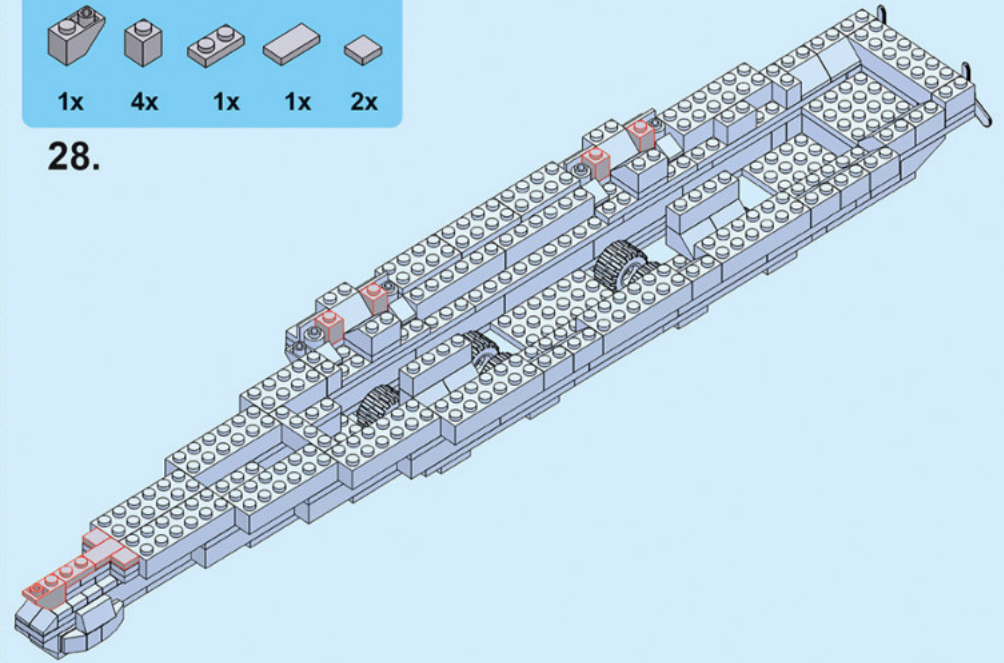

29.

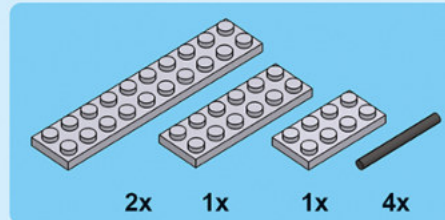
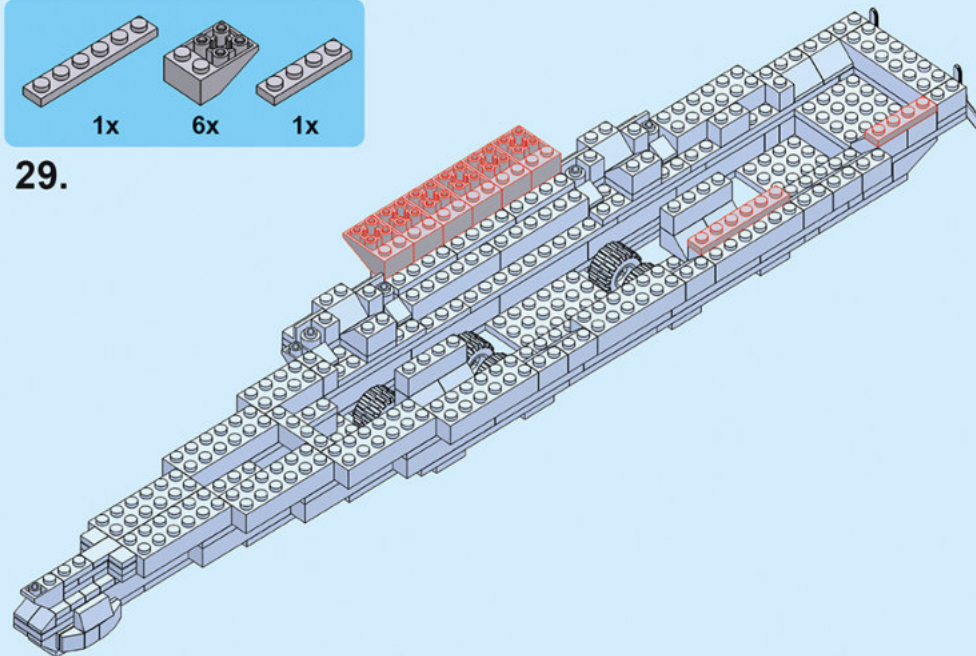

30.

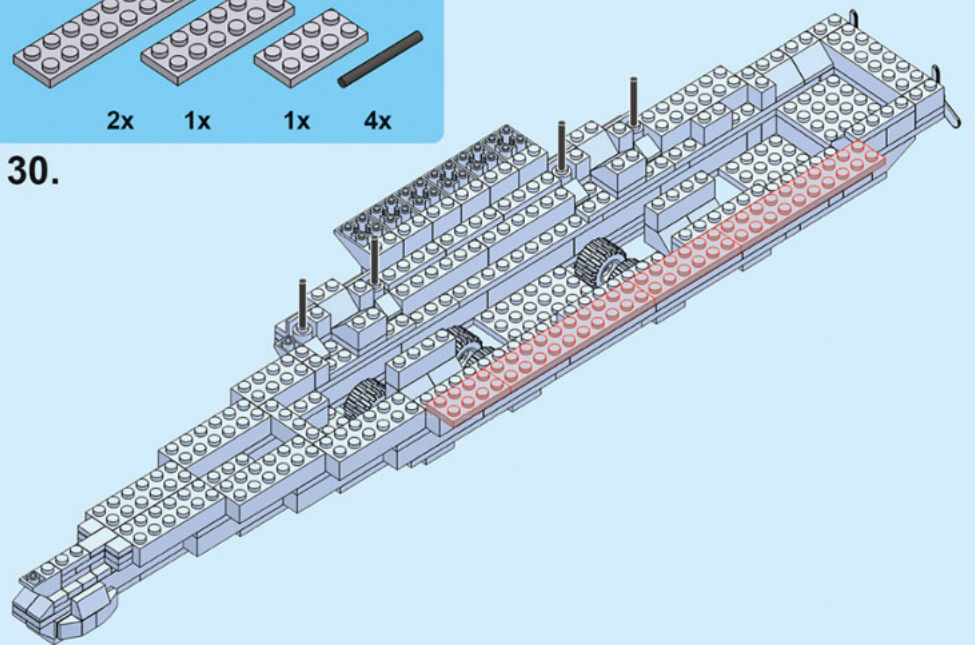

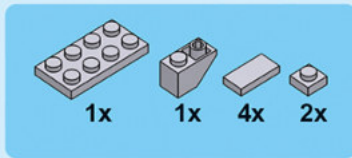

31.

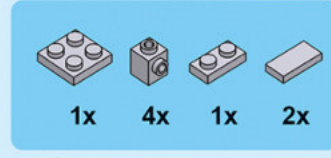
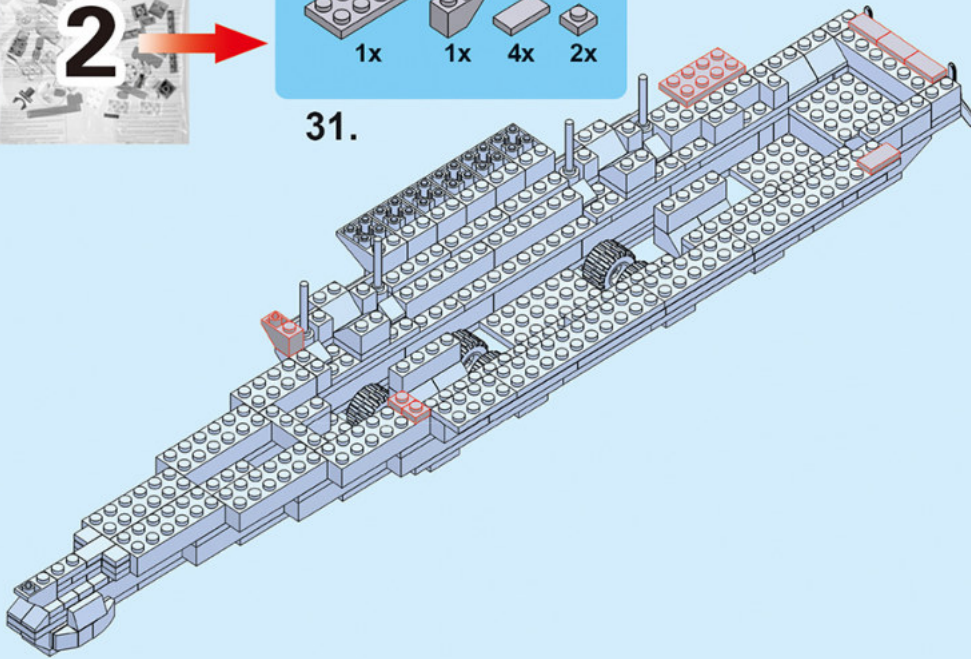

32.

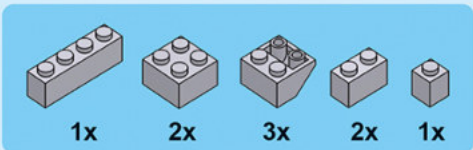
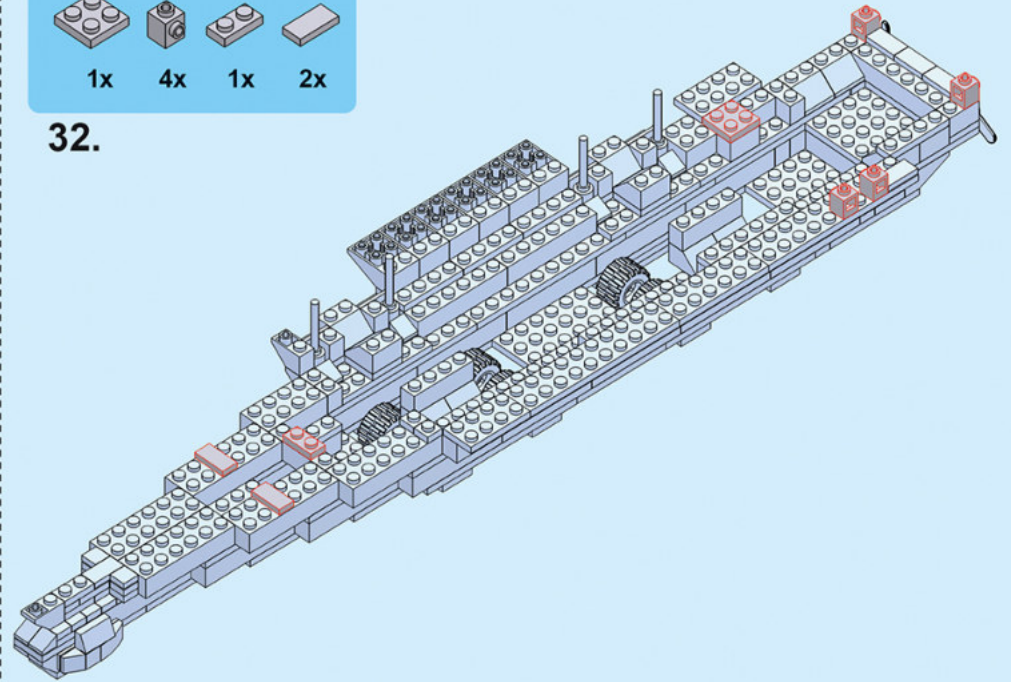

33.

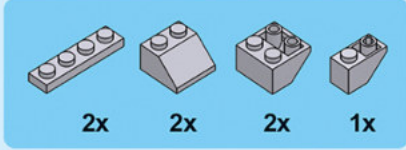
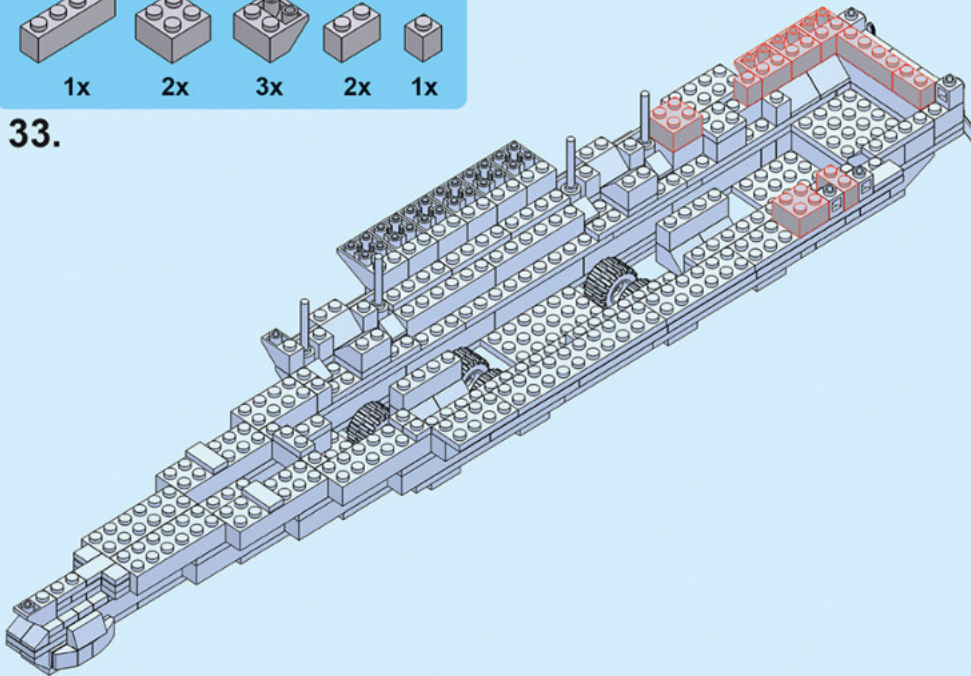

34.

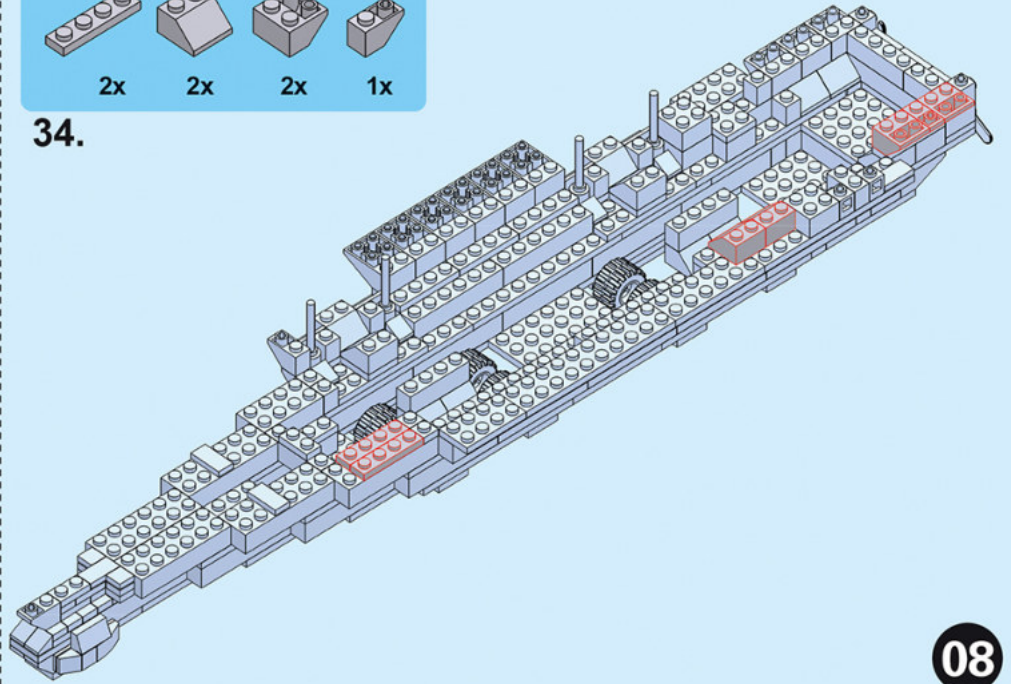

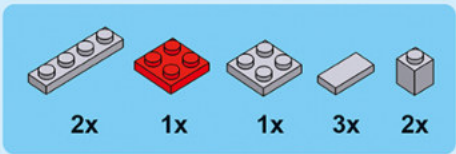

35.

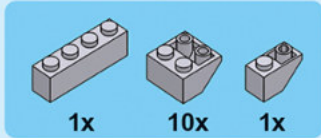
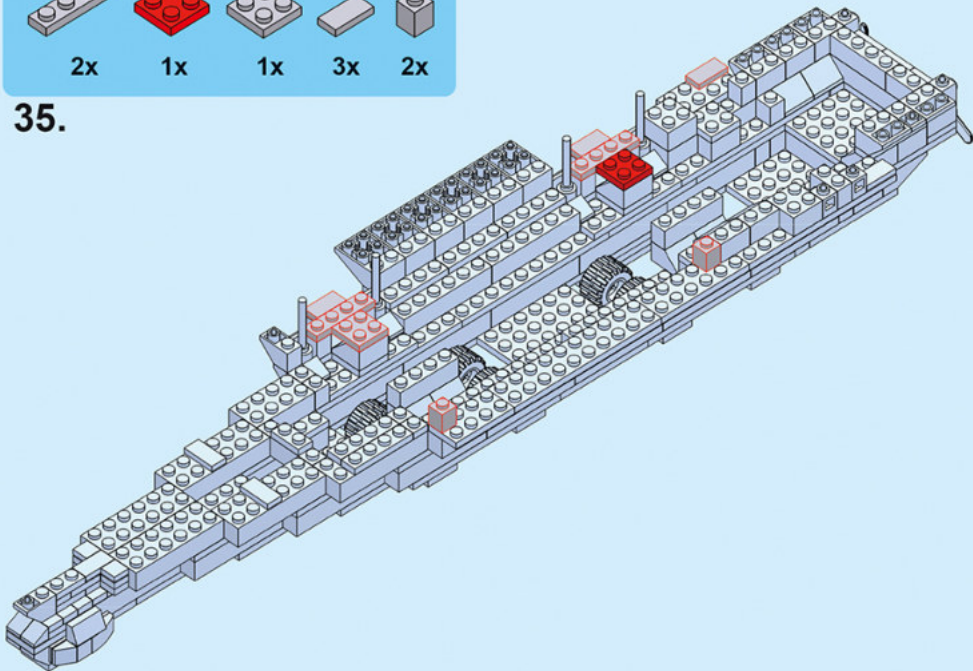

36.

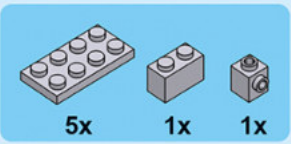
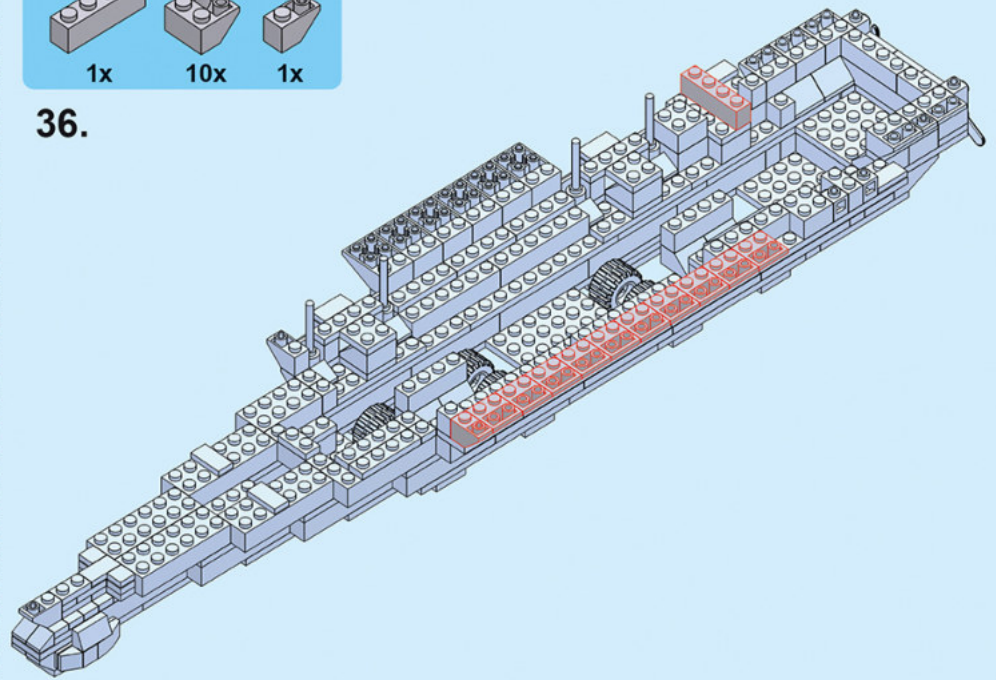

37.

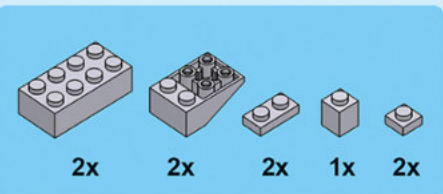
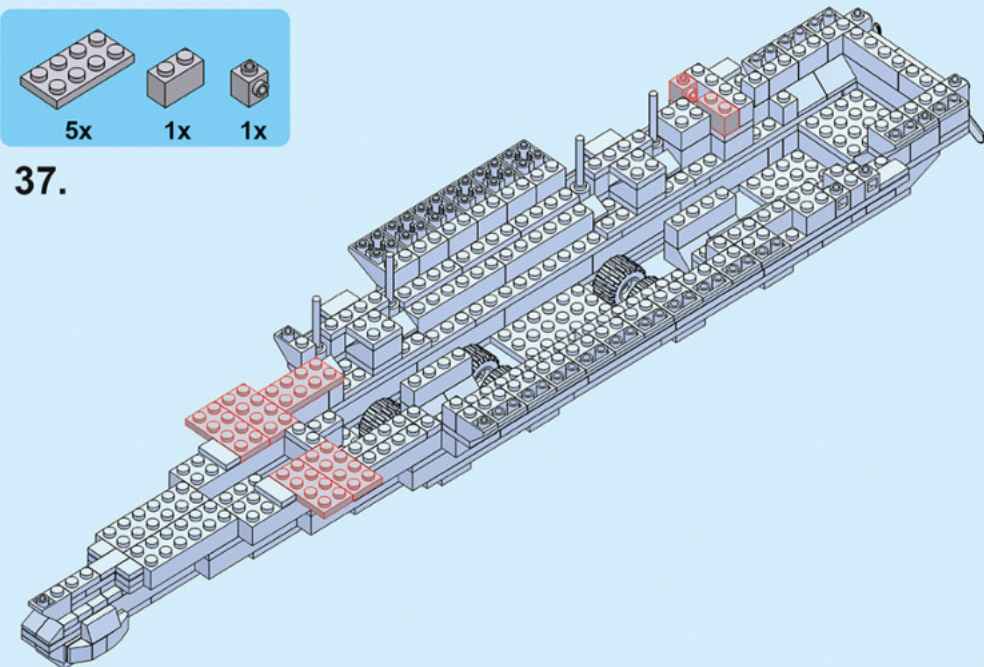

38.

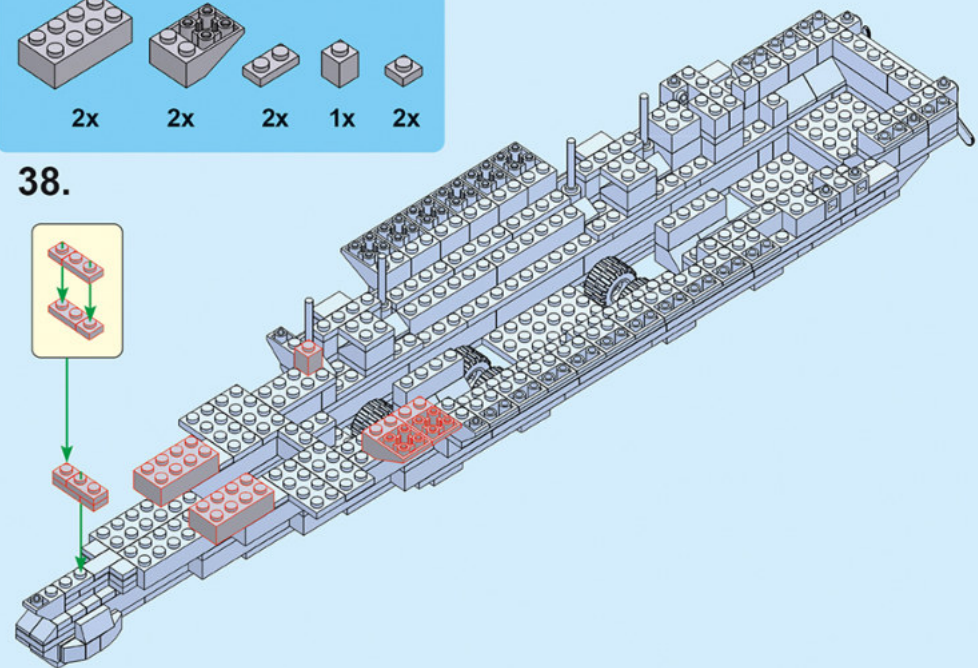

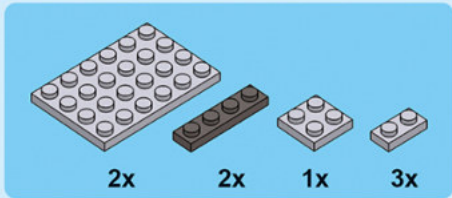

39.

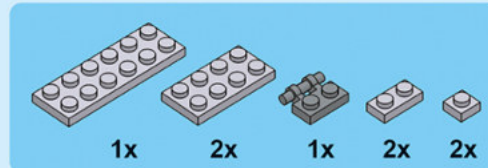
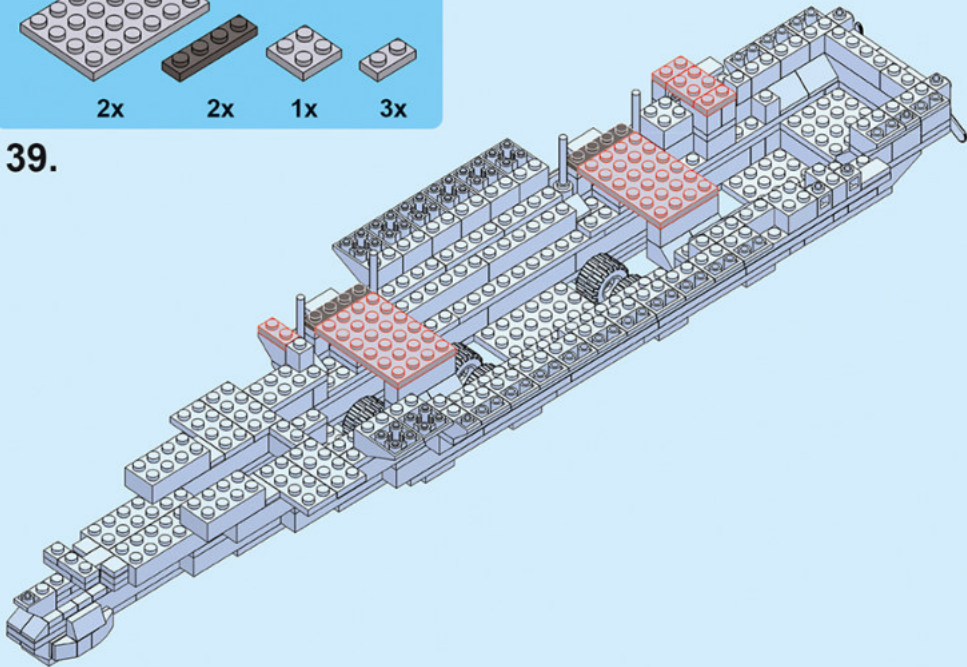

40.

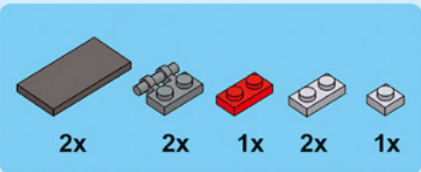
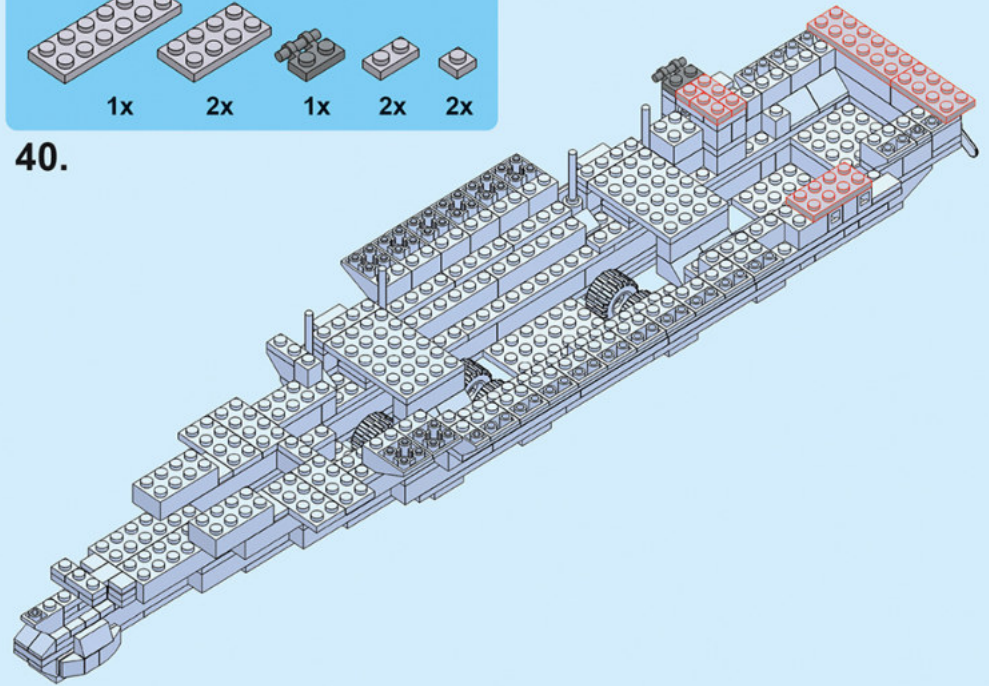

41.

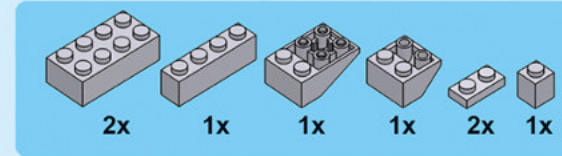
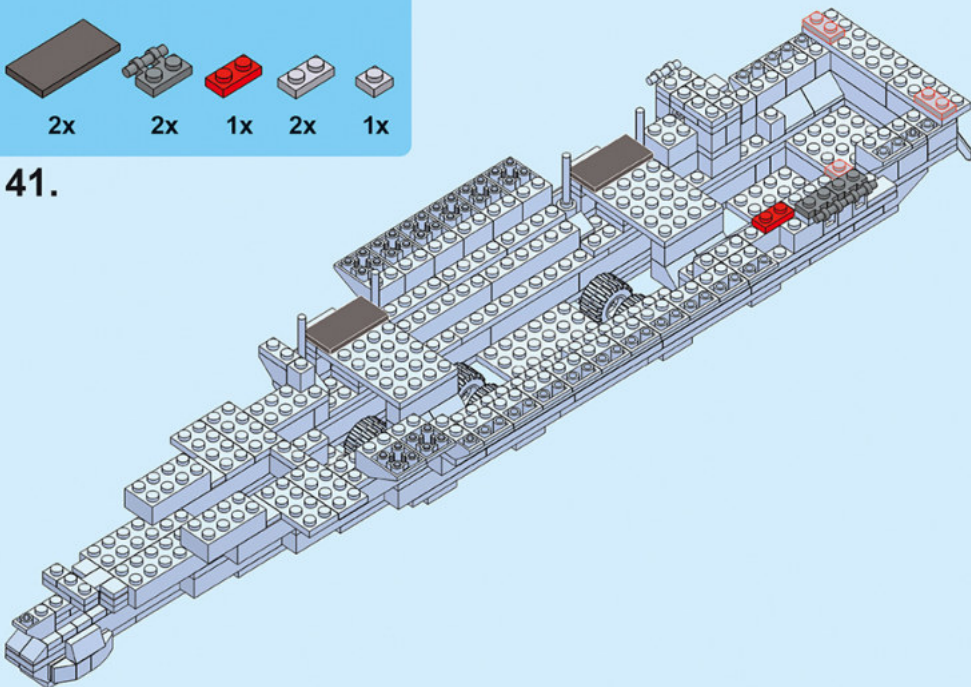

42.

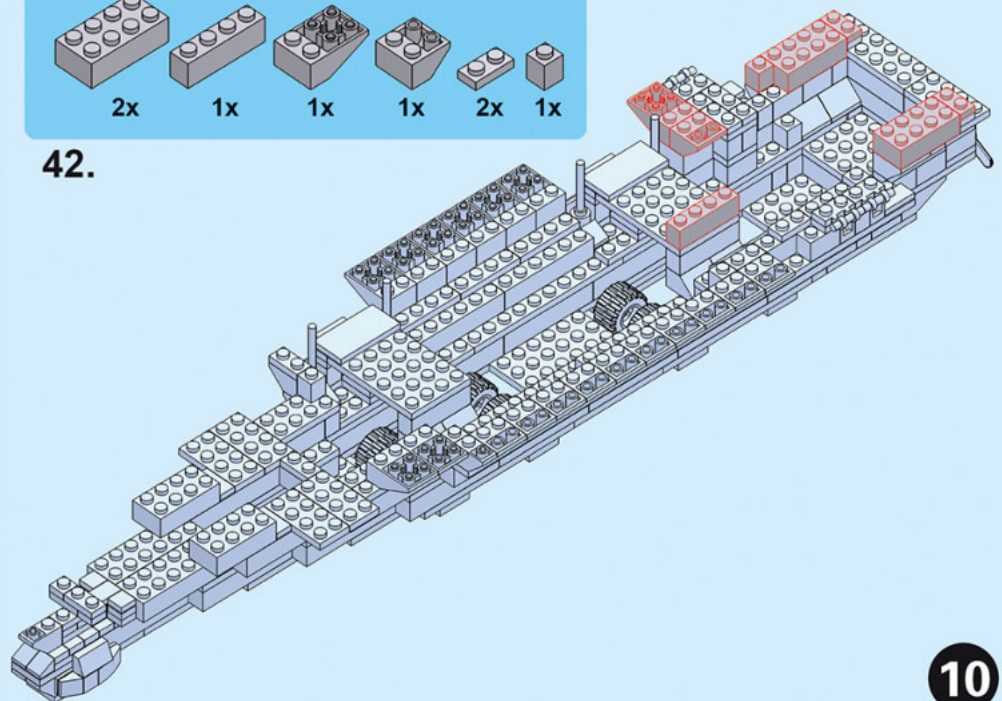

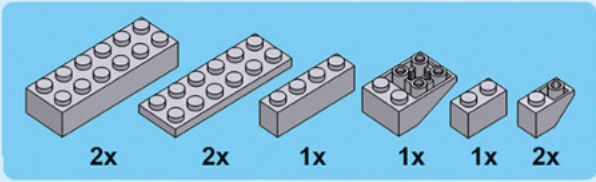

43.

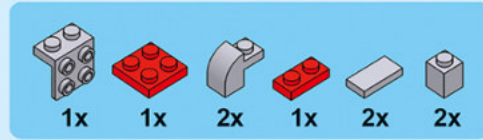
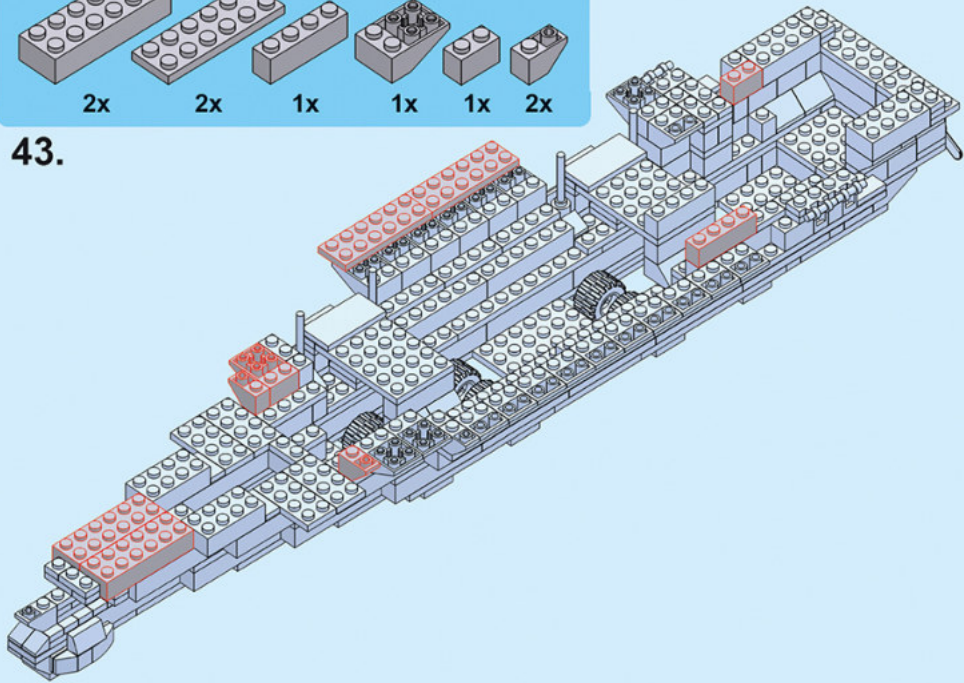

44.

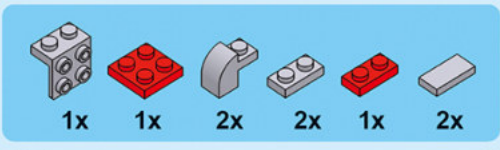
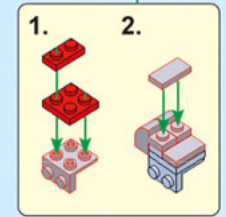
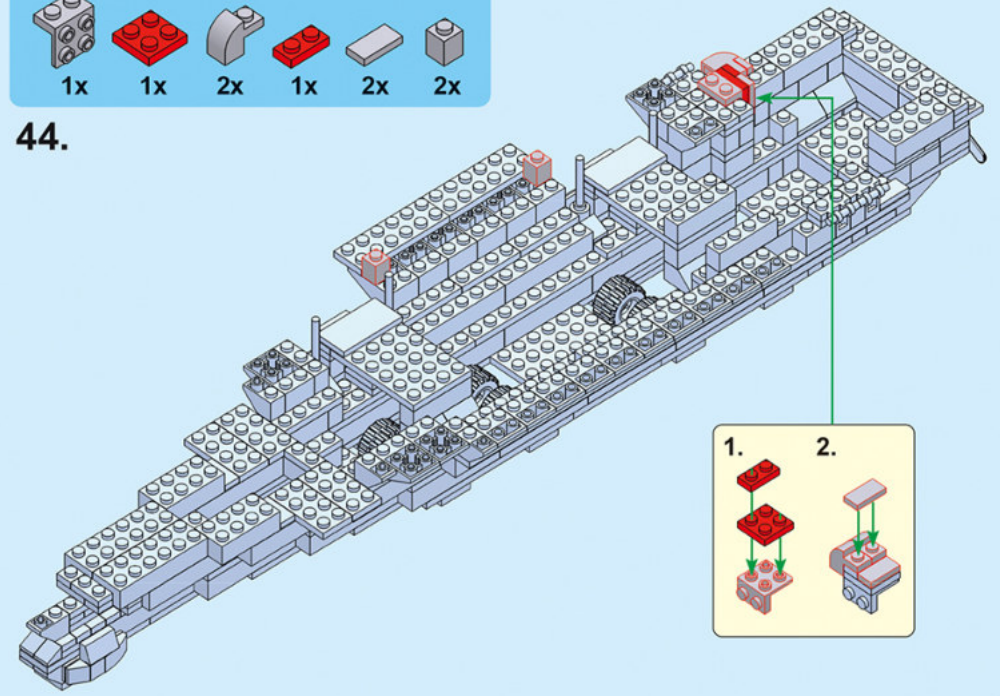

45.

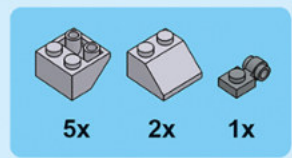
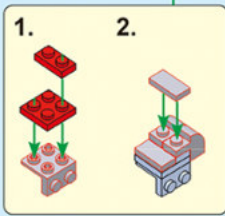
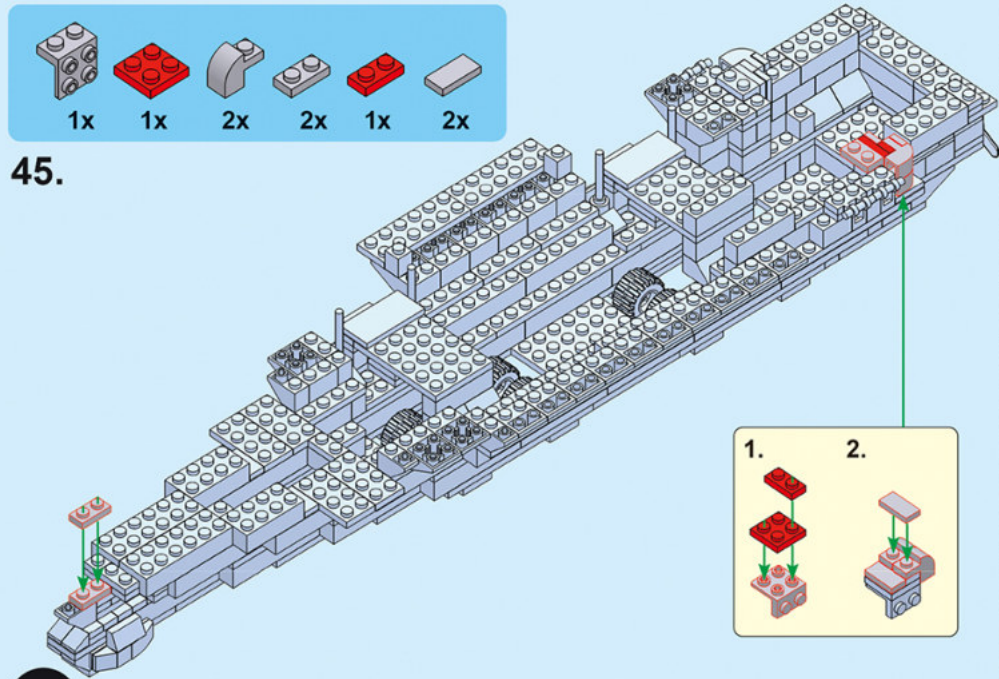

46.

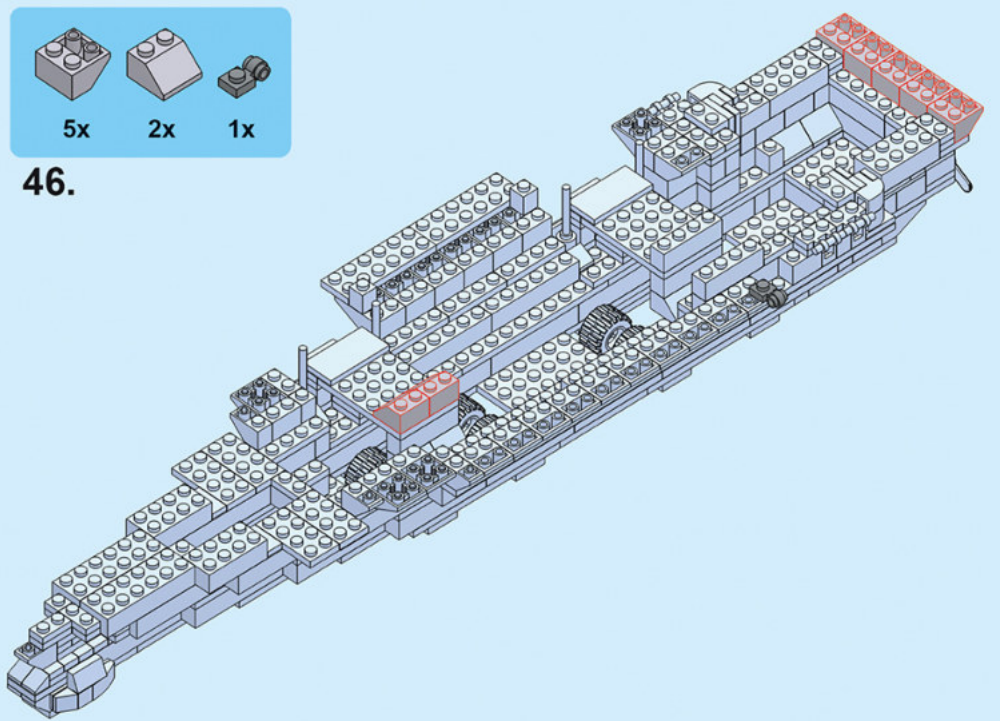

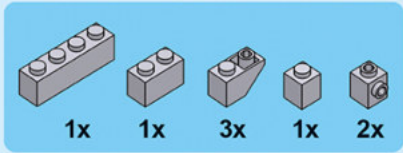

47.

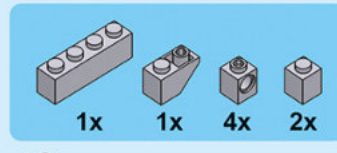
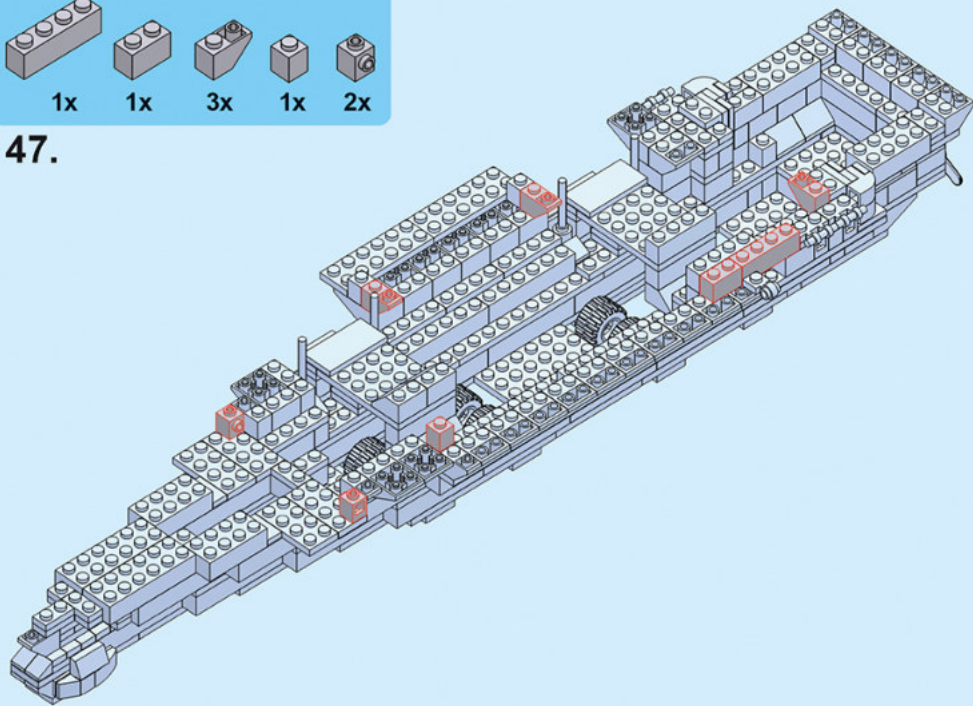

48.

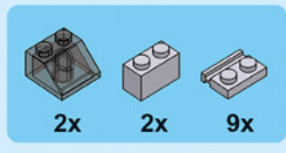
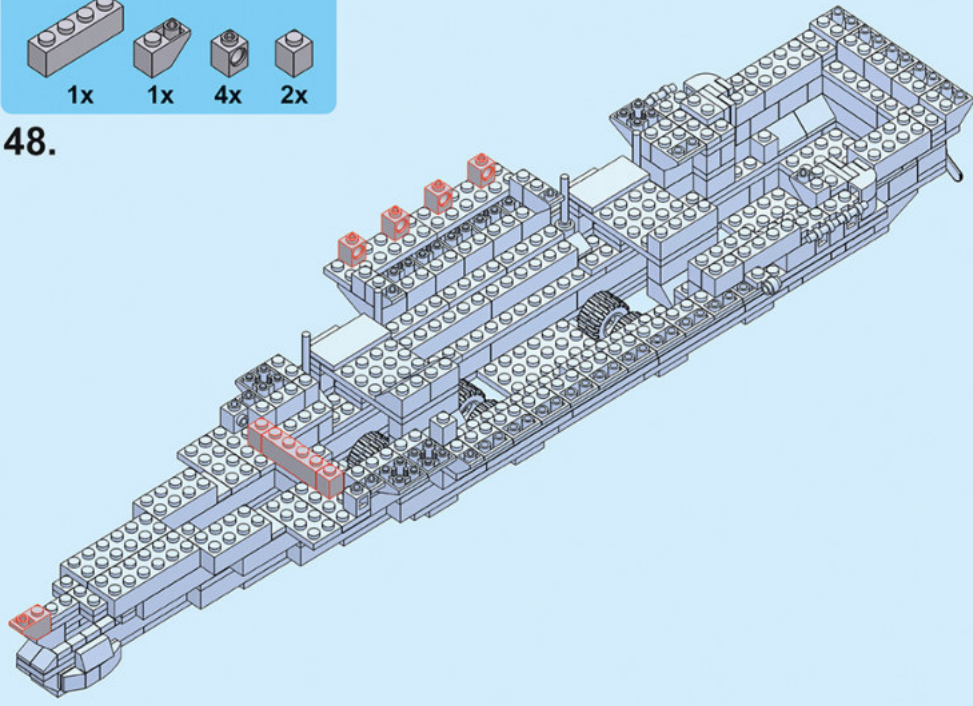

49.

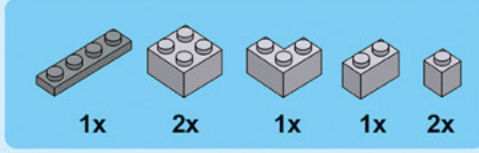
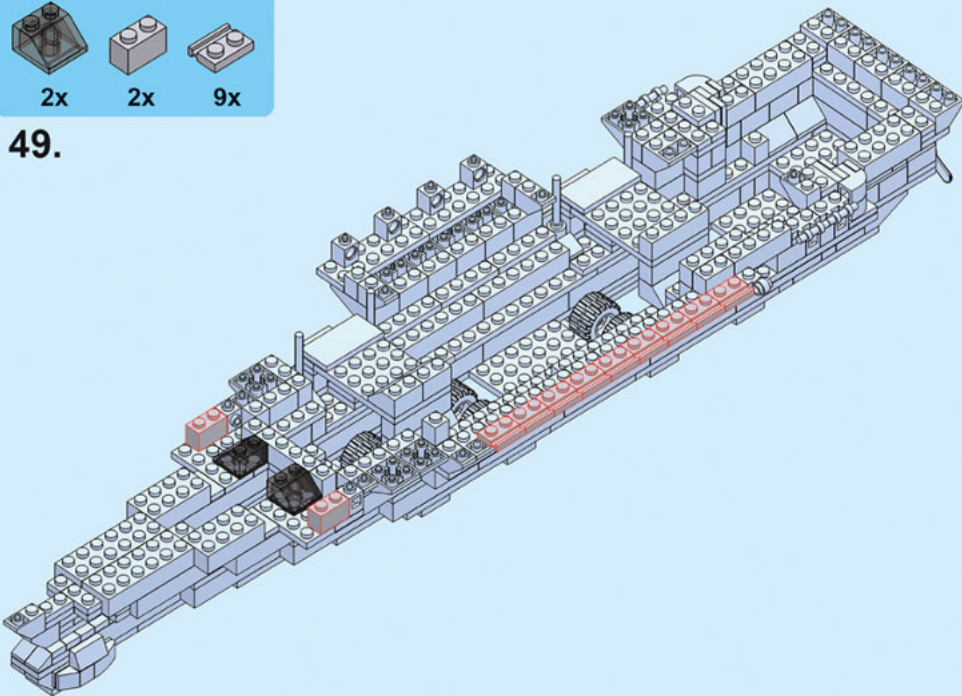

50.

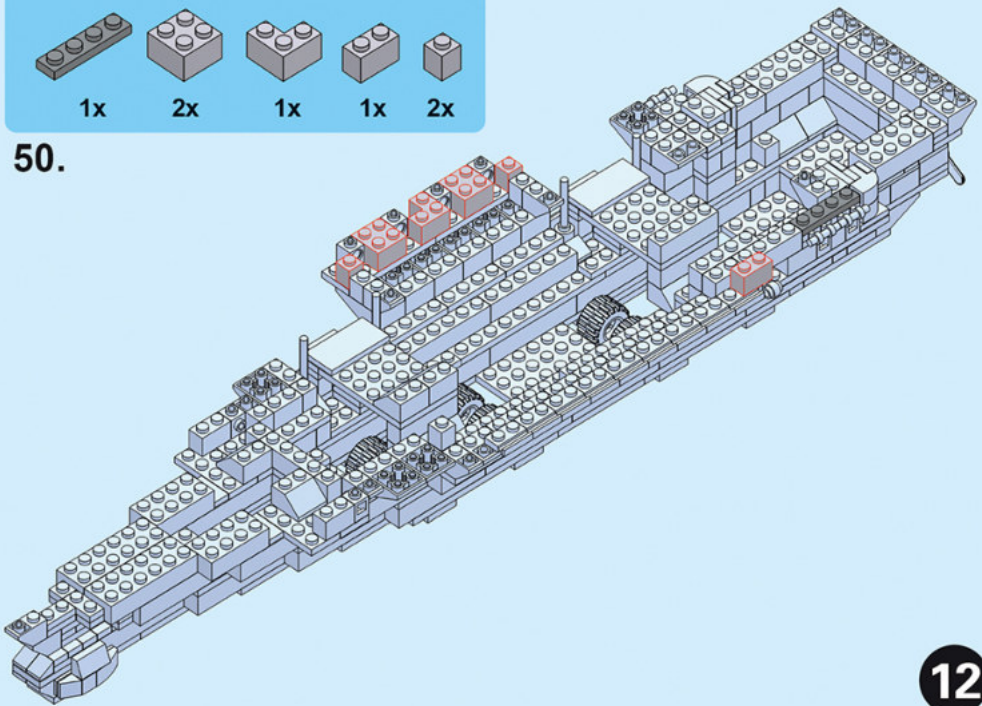

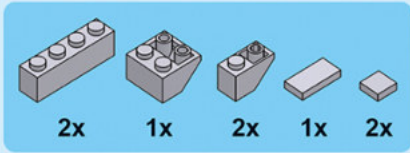

51.

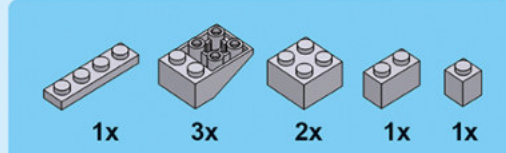
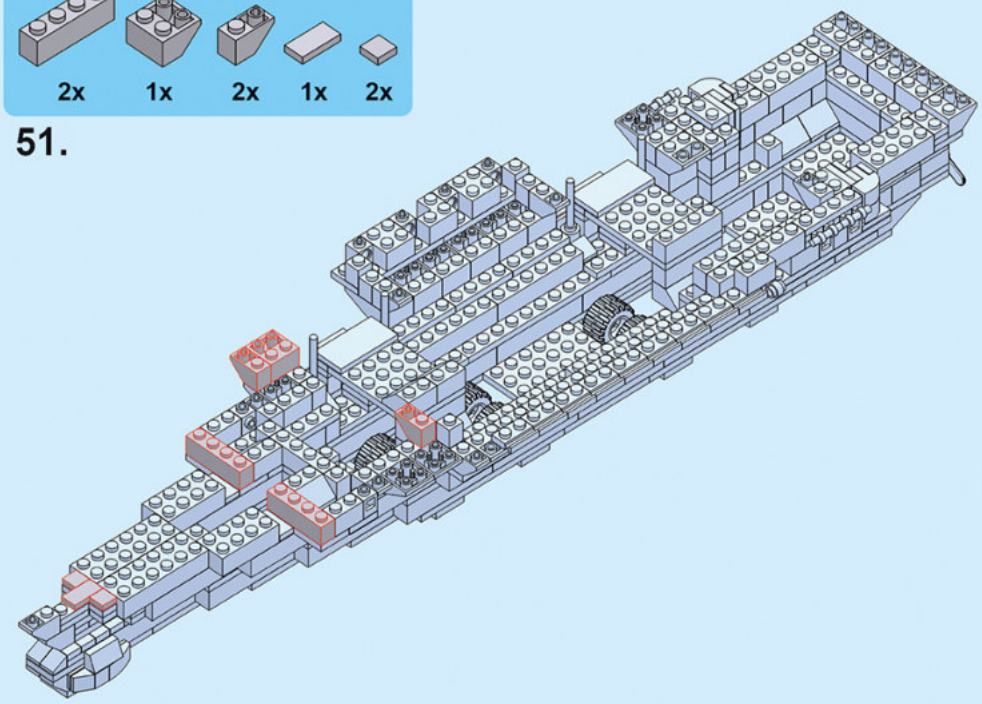

52.

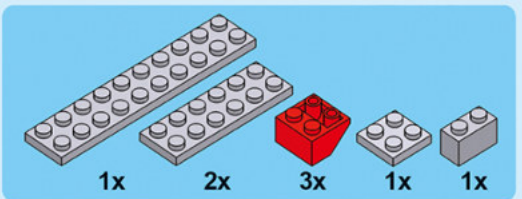
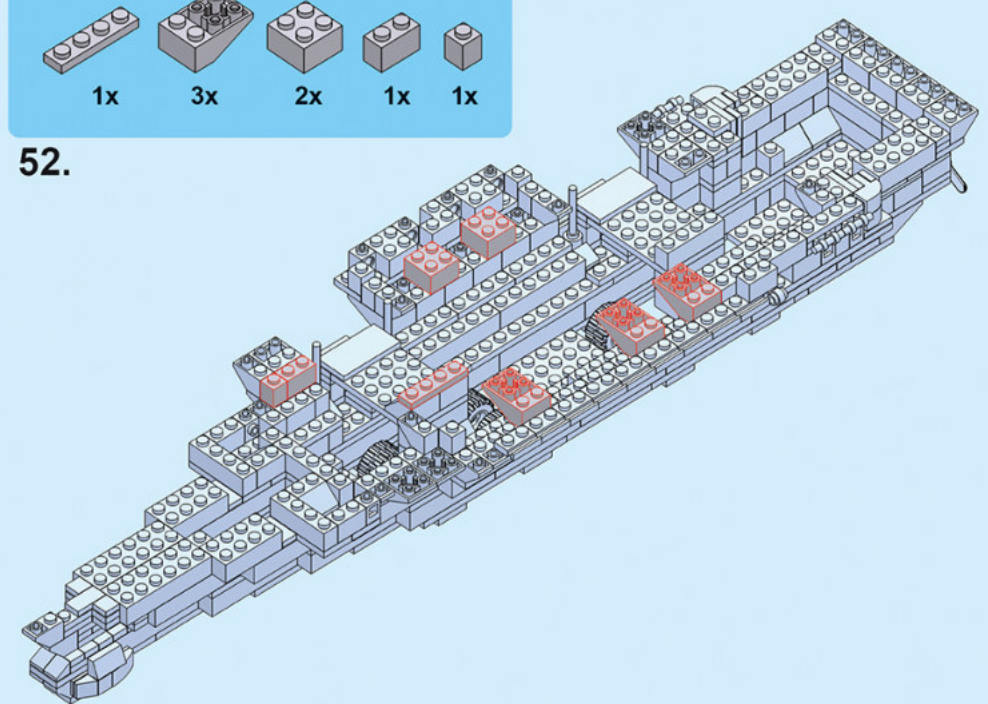

53.

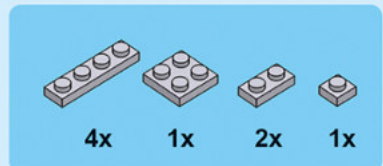
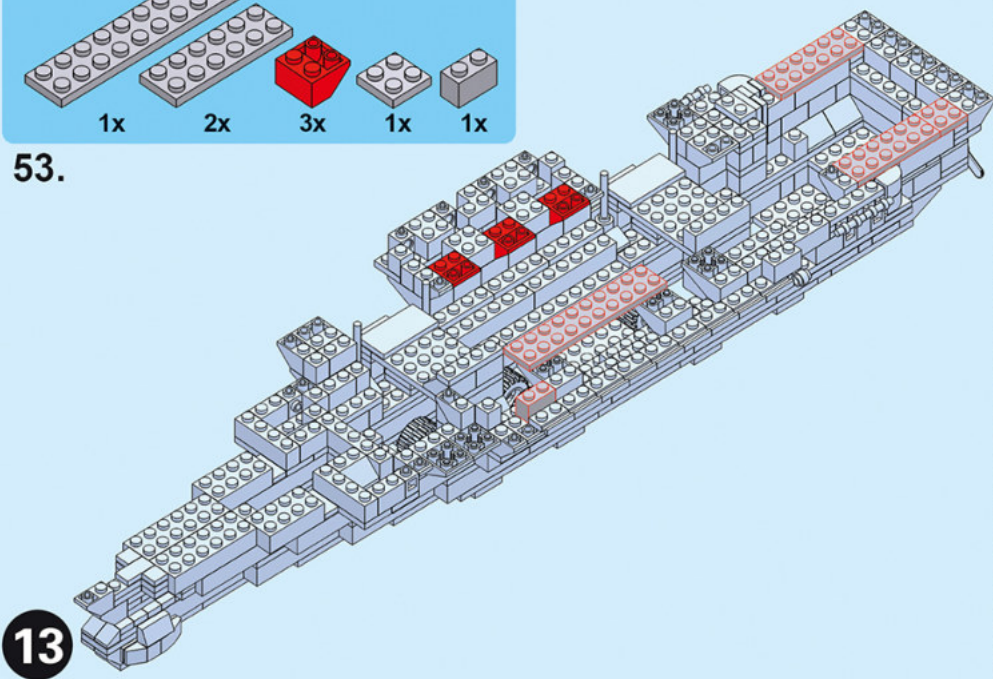

54.

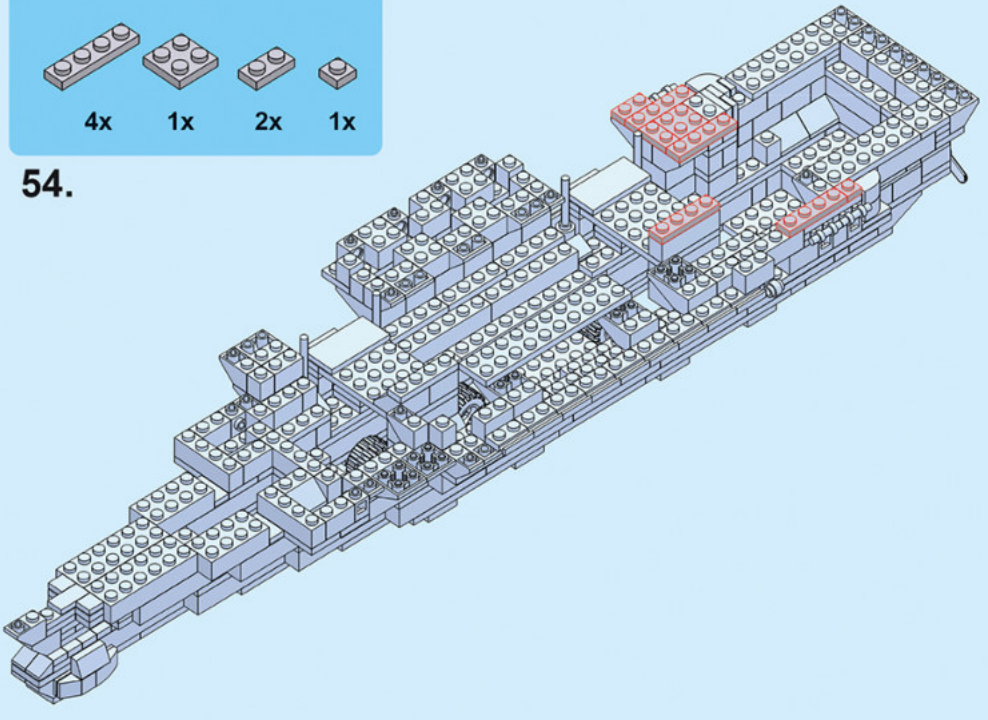

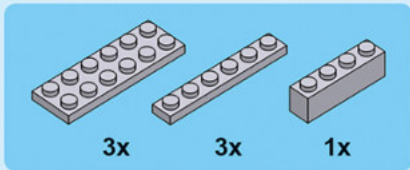

55.

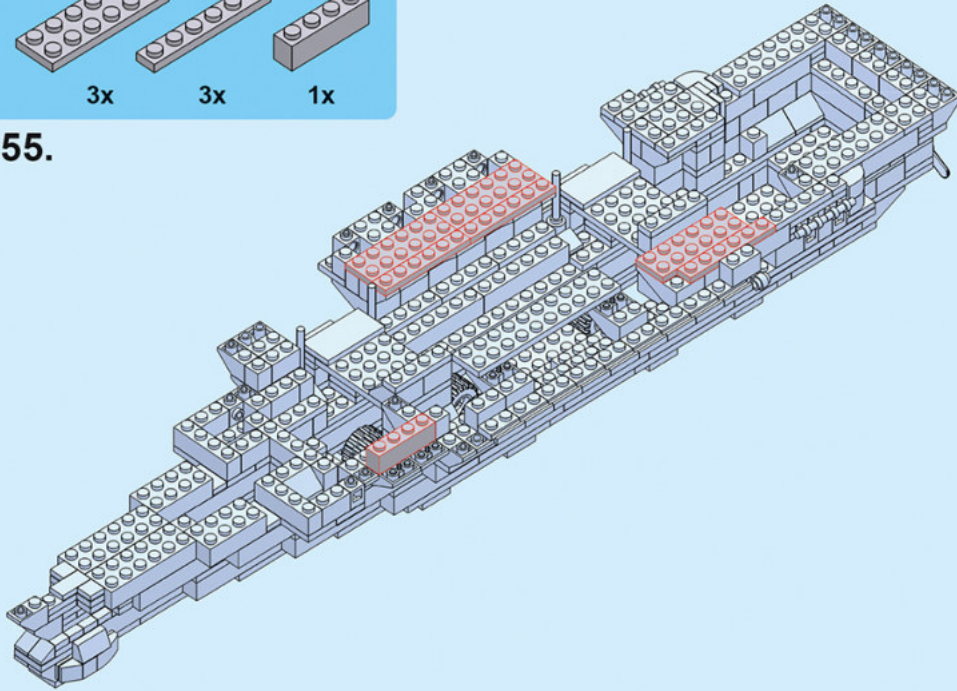

3

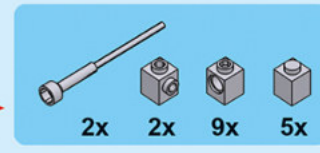

56.

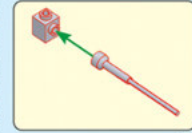

x2

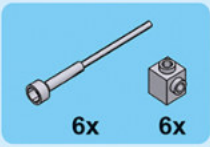
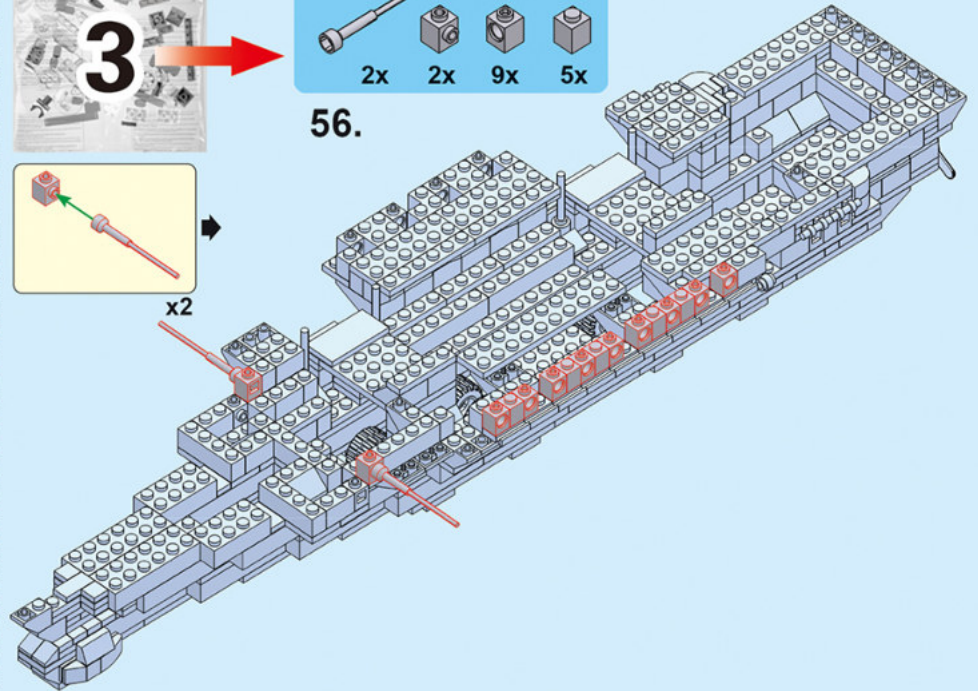

57.

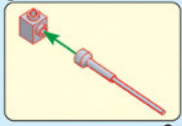

x6

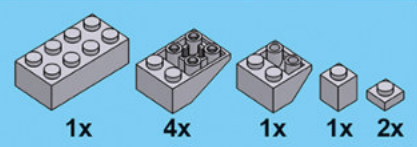
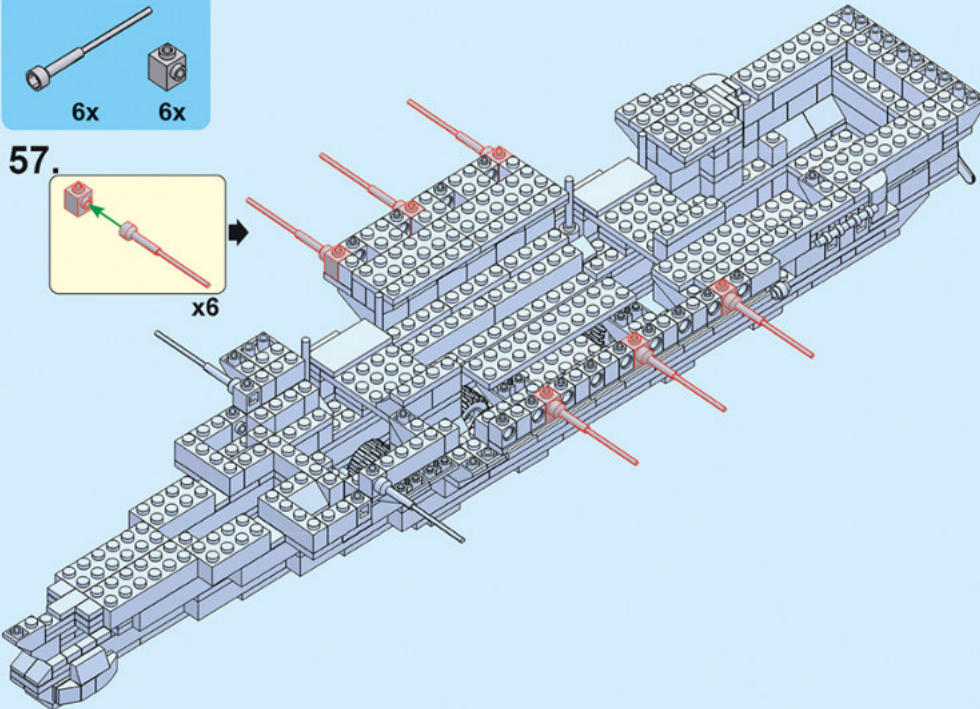

58.

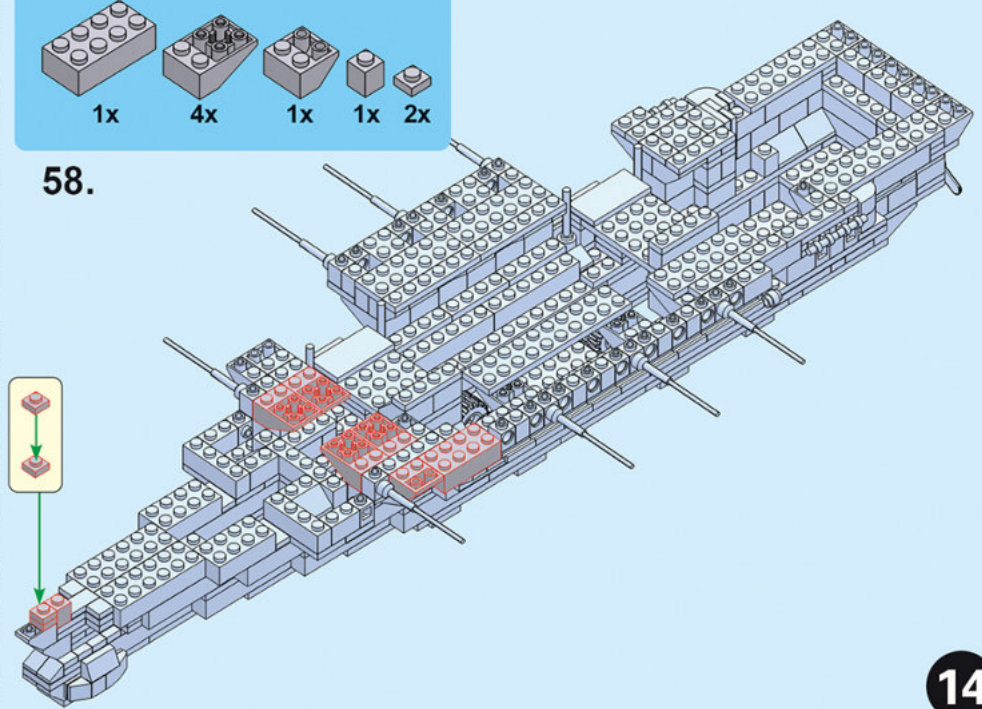
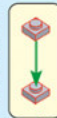

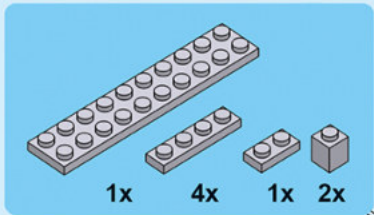

59.

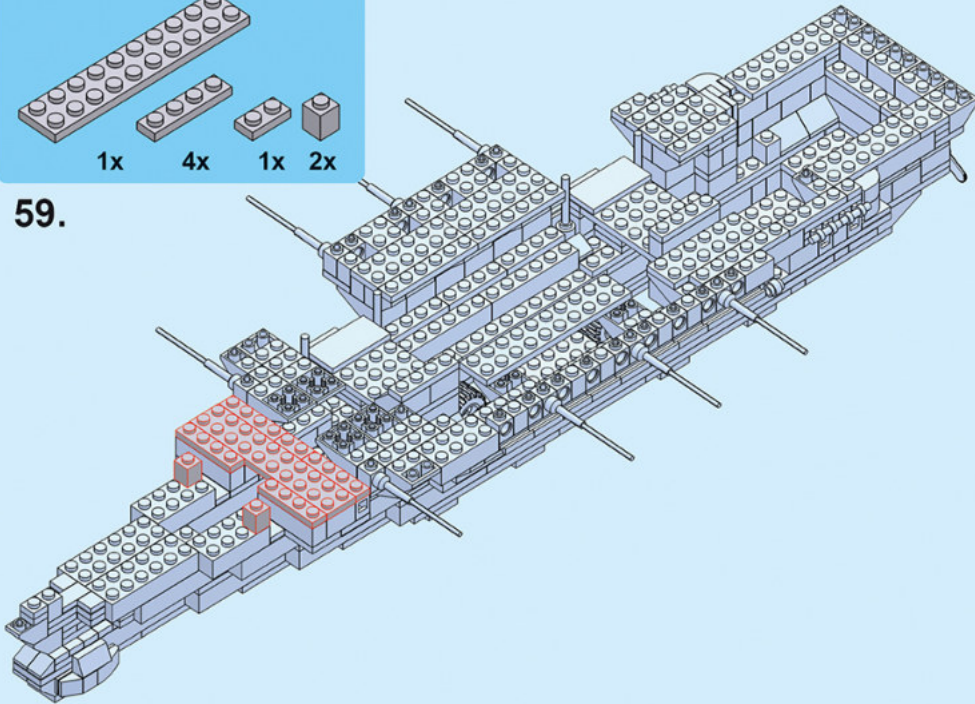

60.

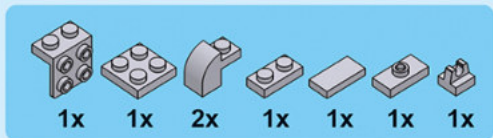
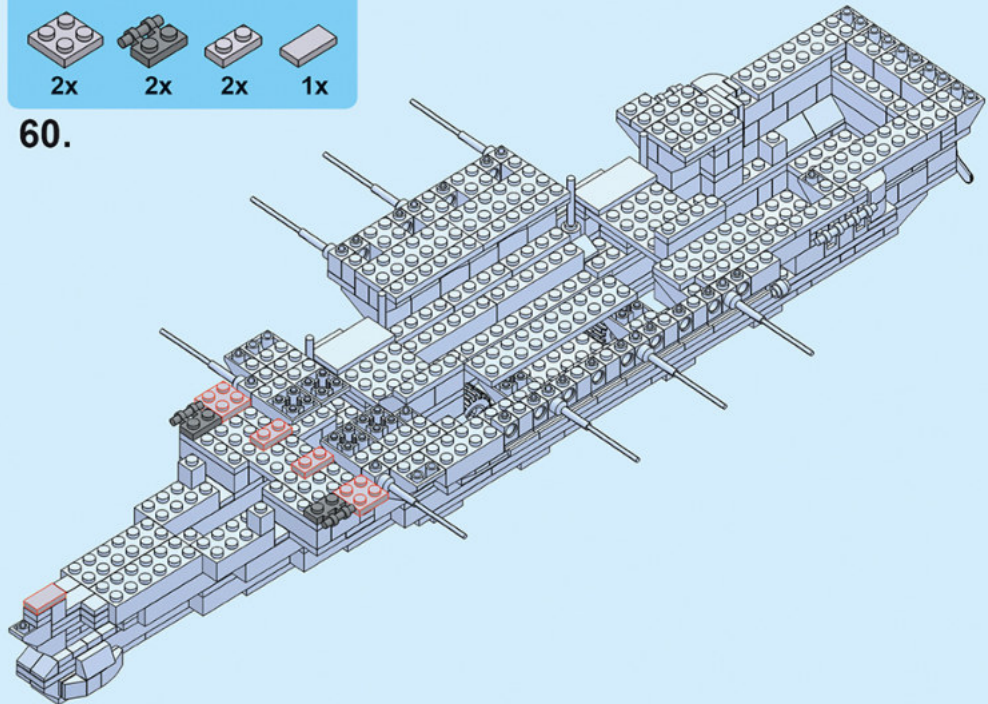

61.

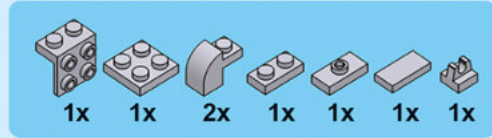
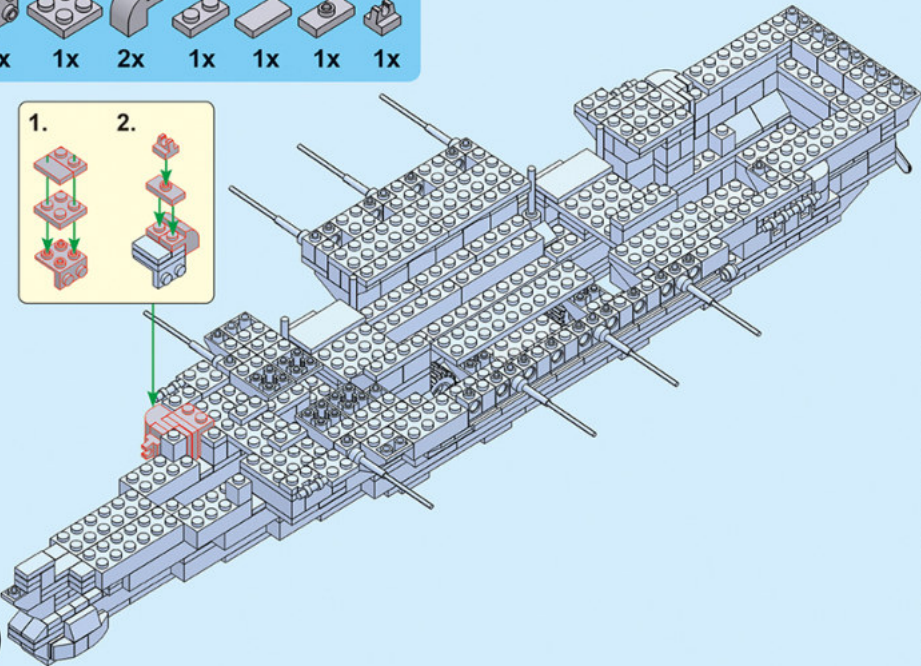
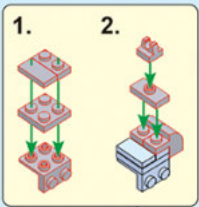

62.

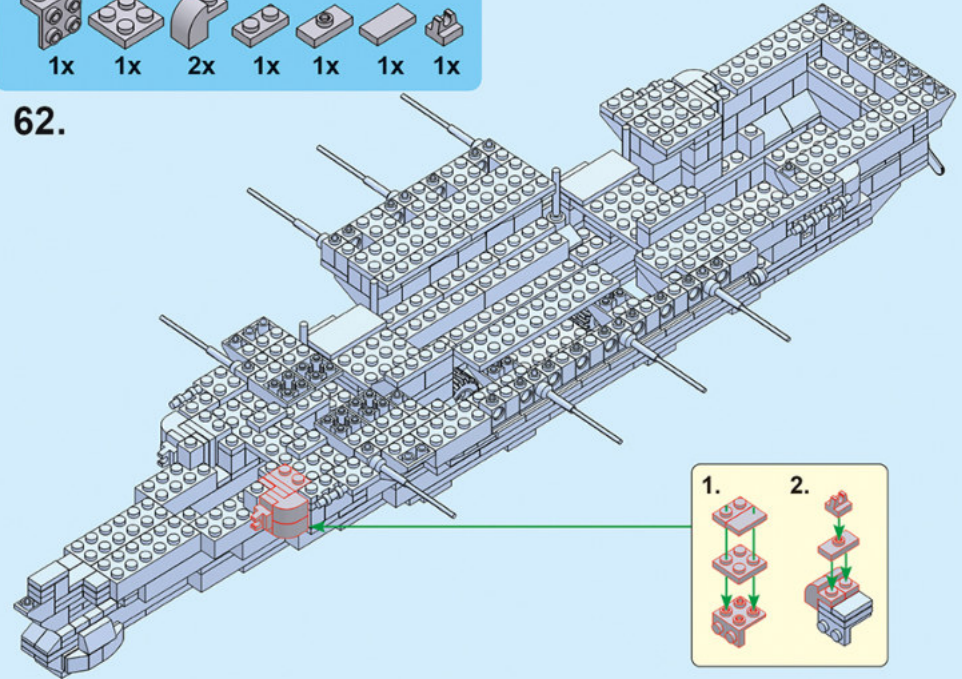
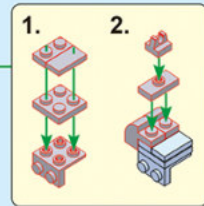

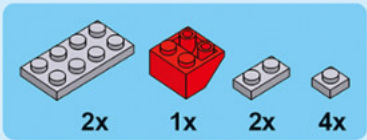

63.

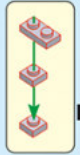
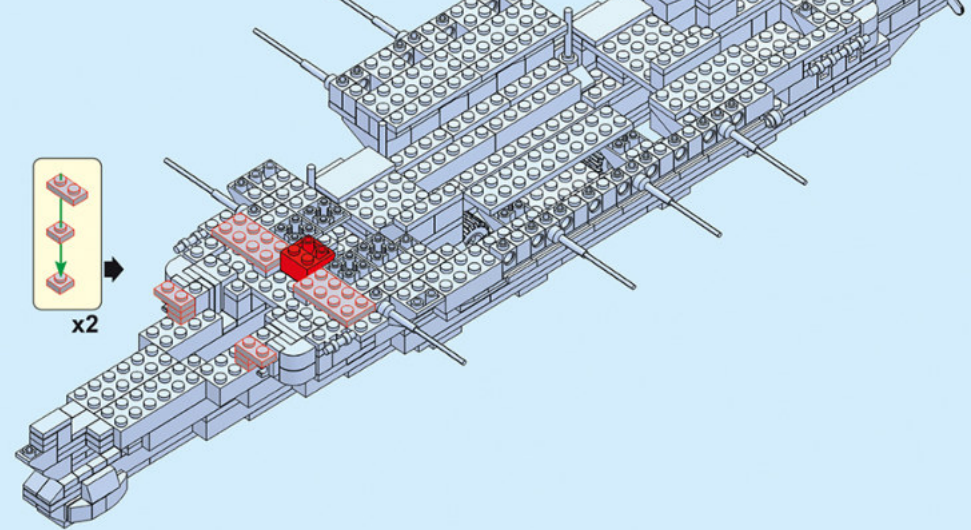

x2

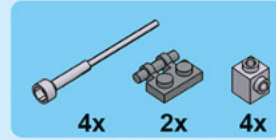

64.

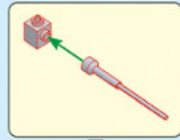
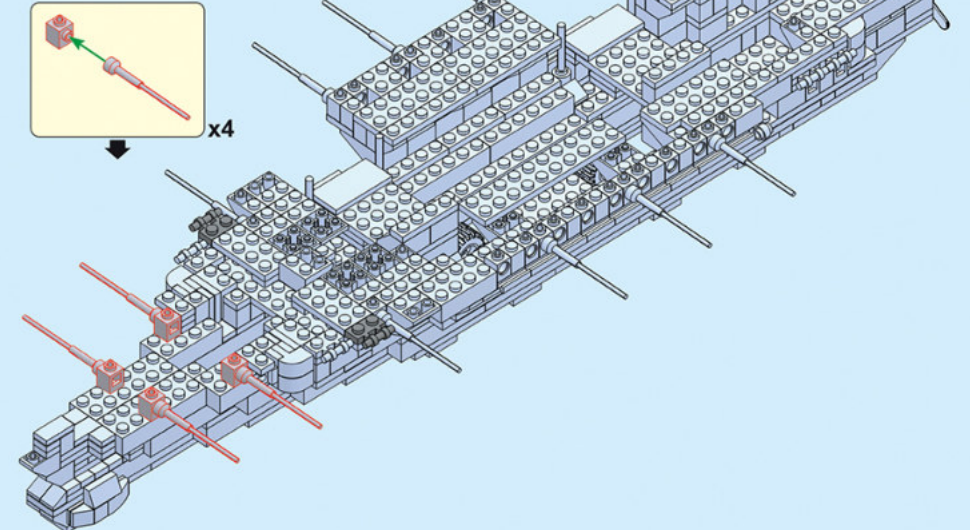

x4

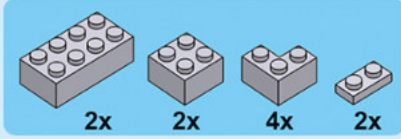

65.

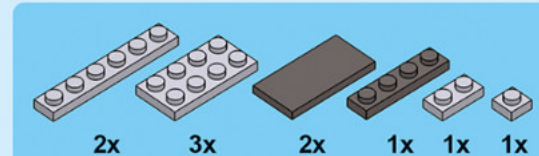
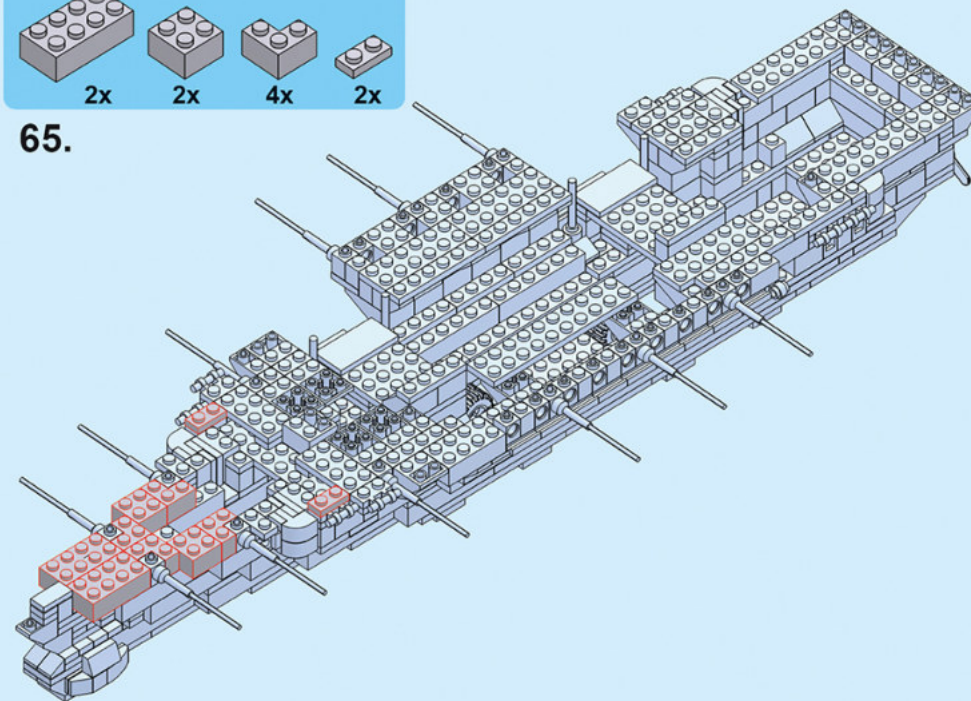

66.

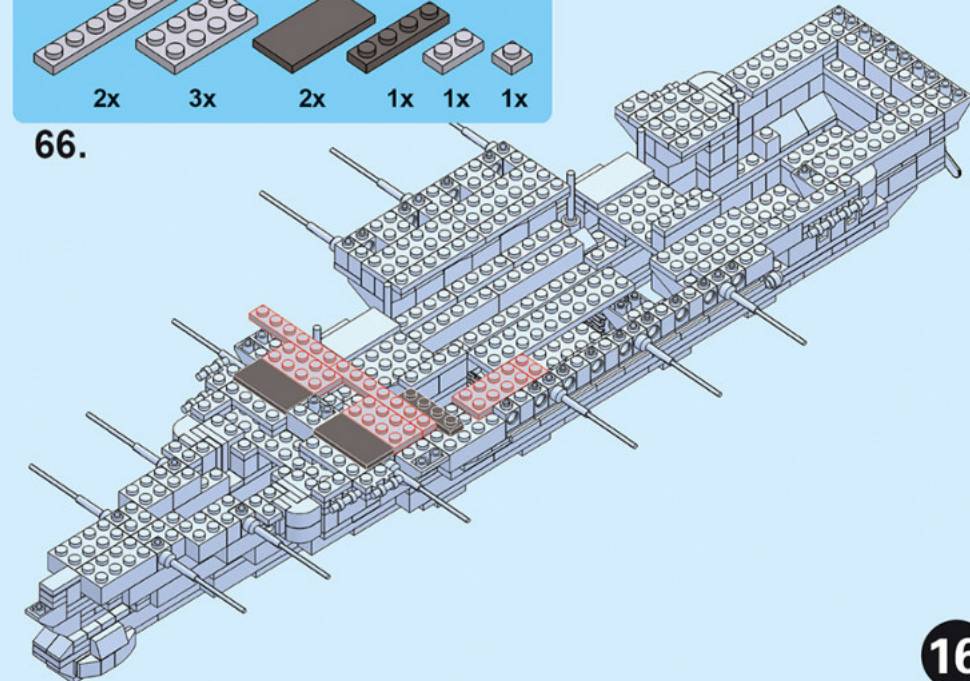

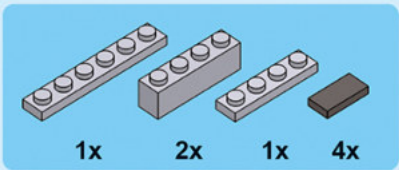

67.

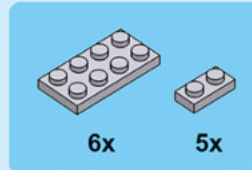
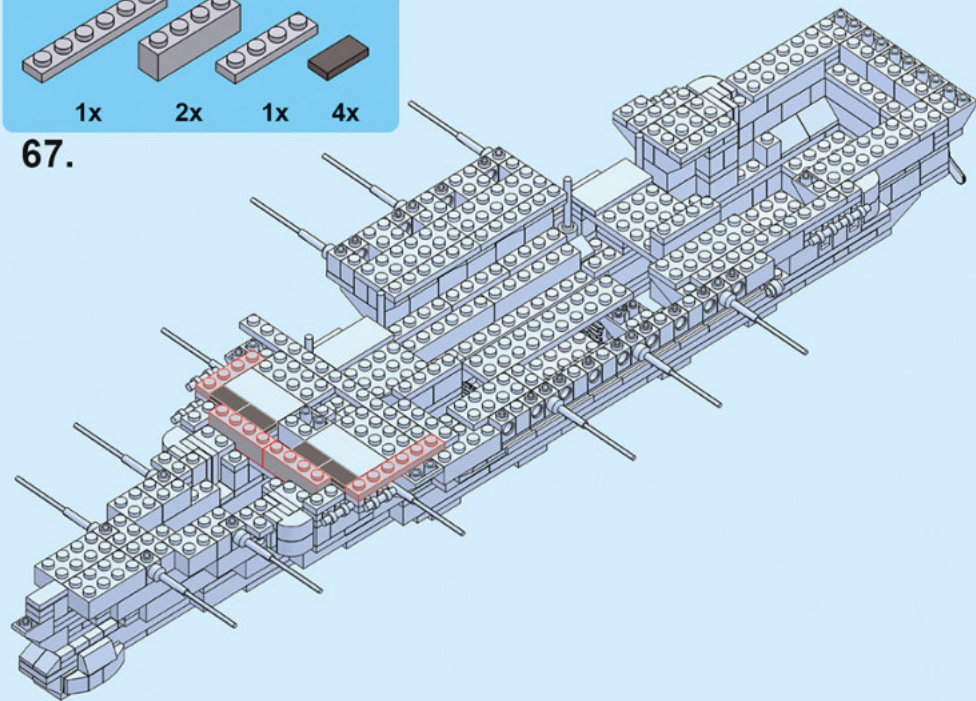

68.

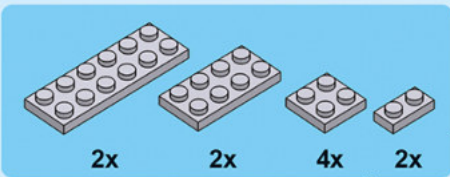
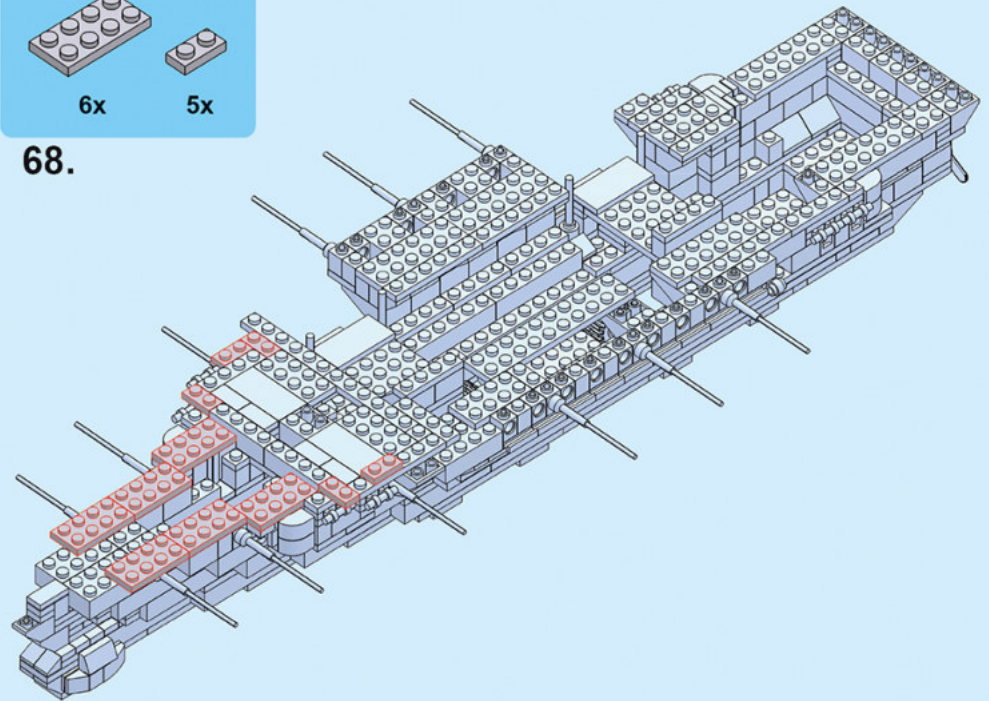

69.

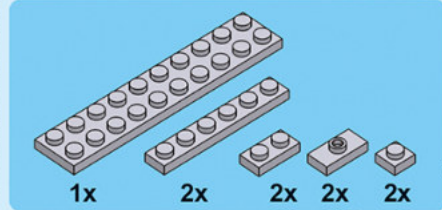
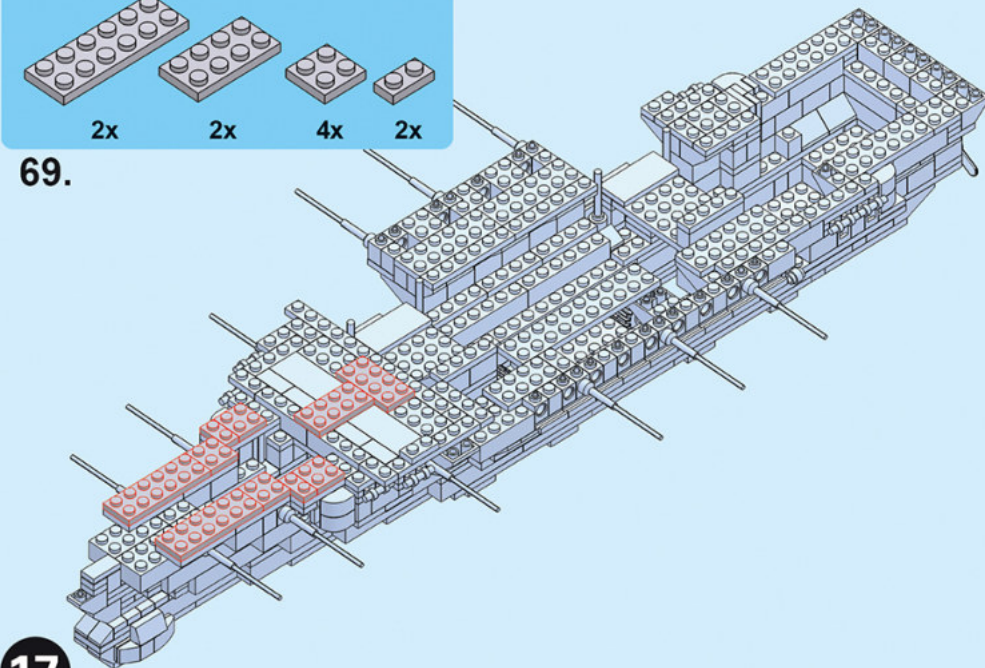

70.

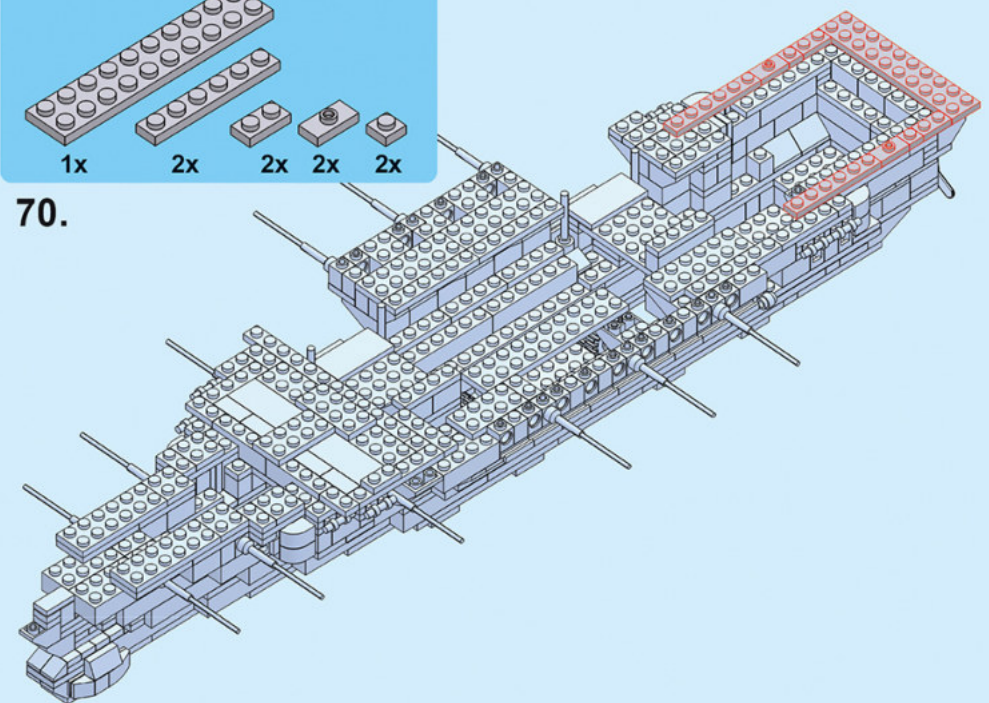

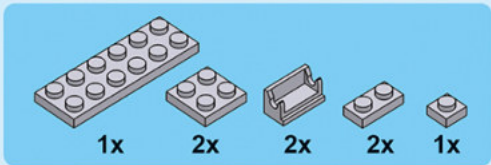

71.

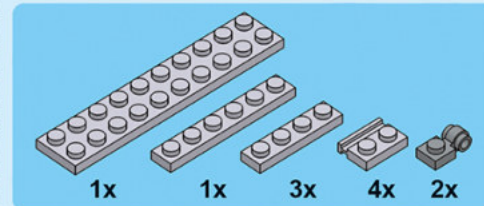
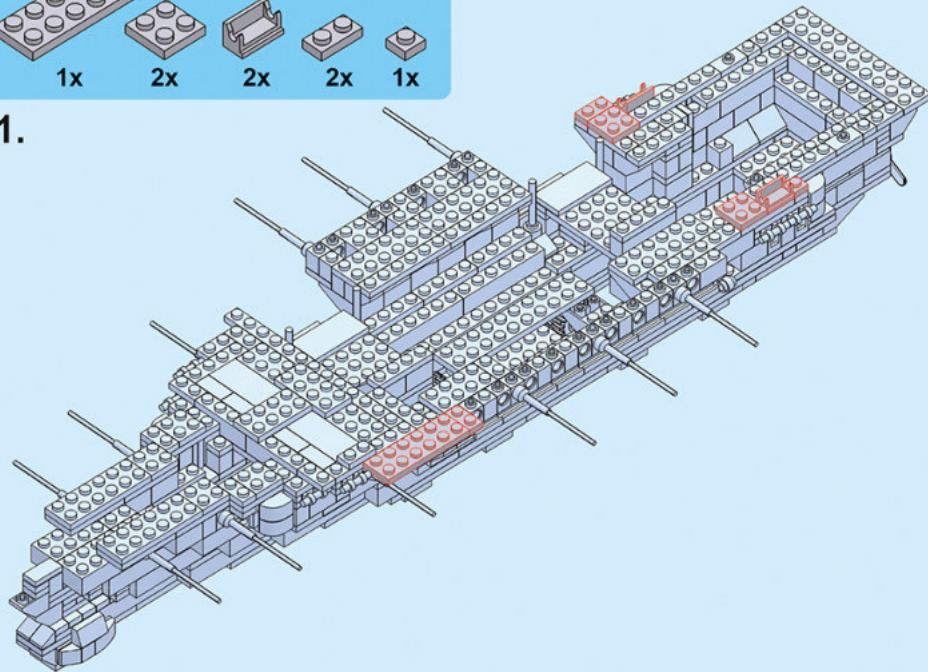

72.

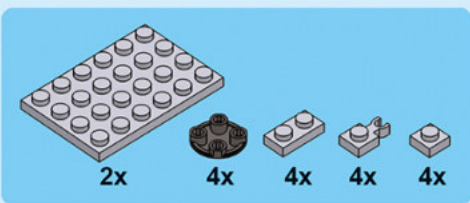
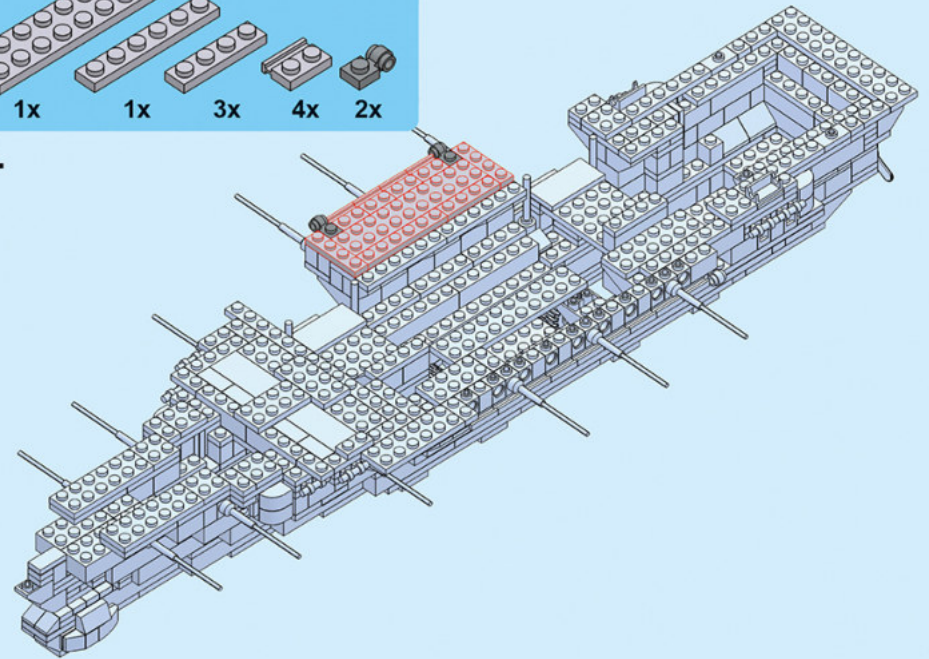

73.

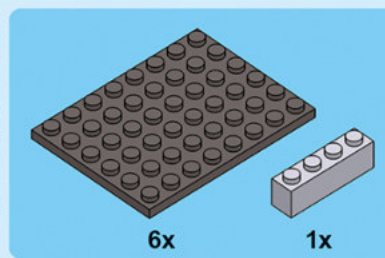
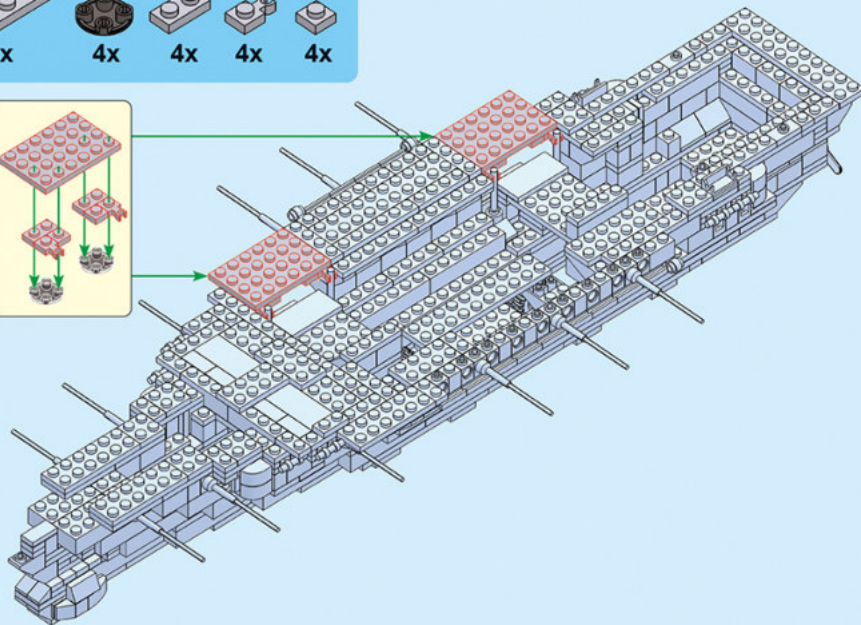
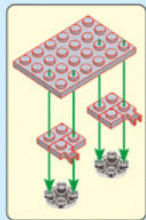

74.

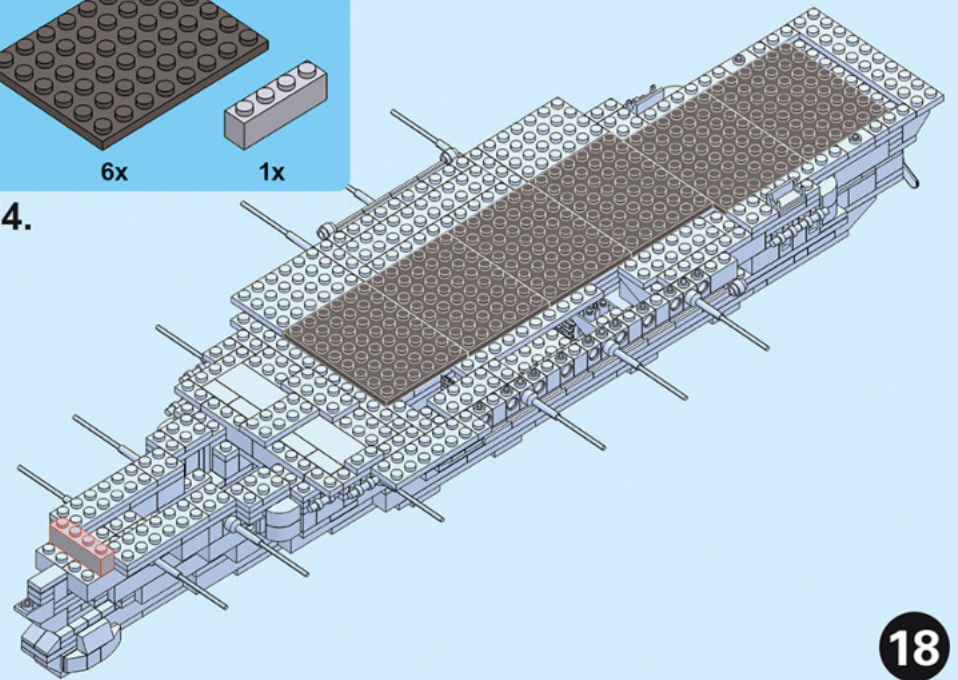

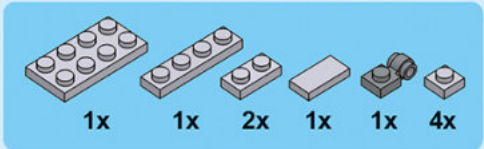

75.

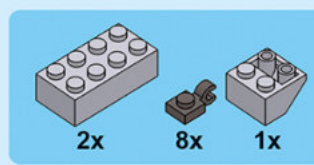
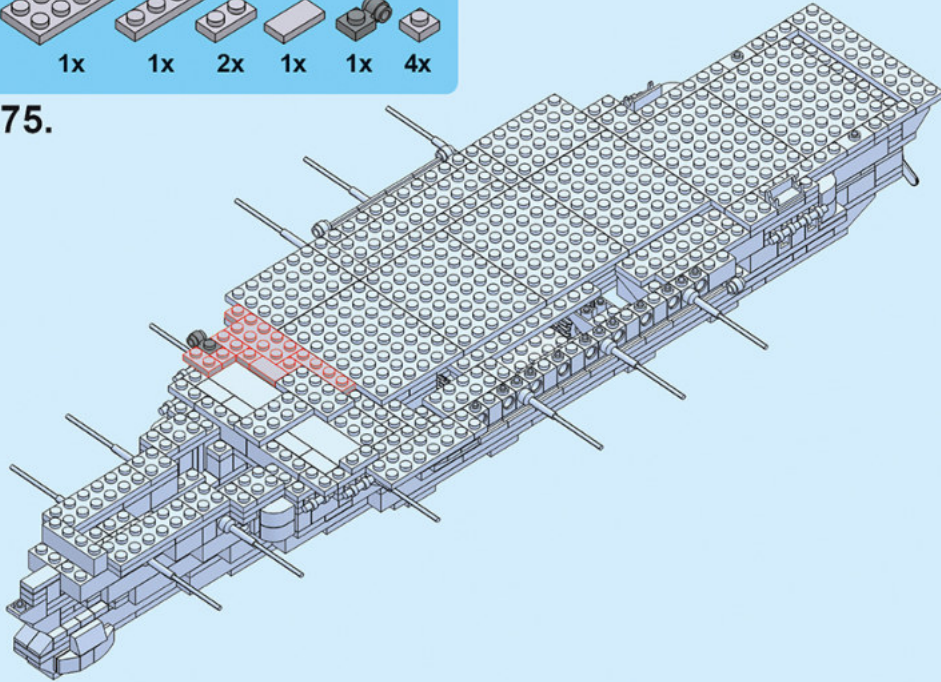

76.

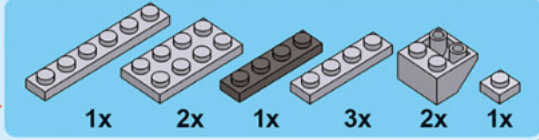
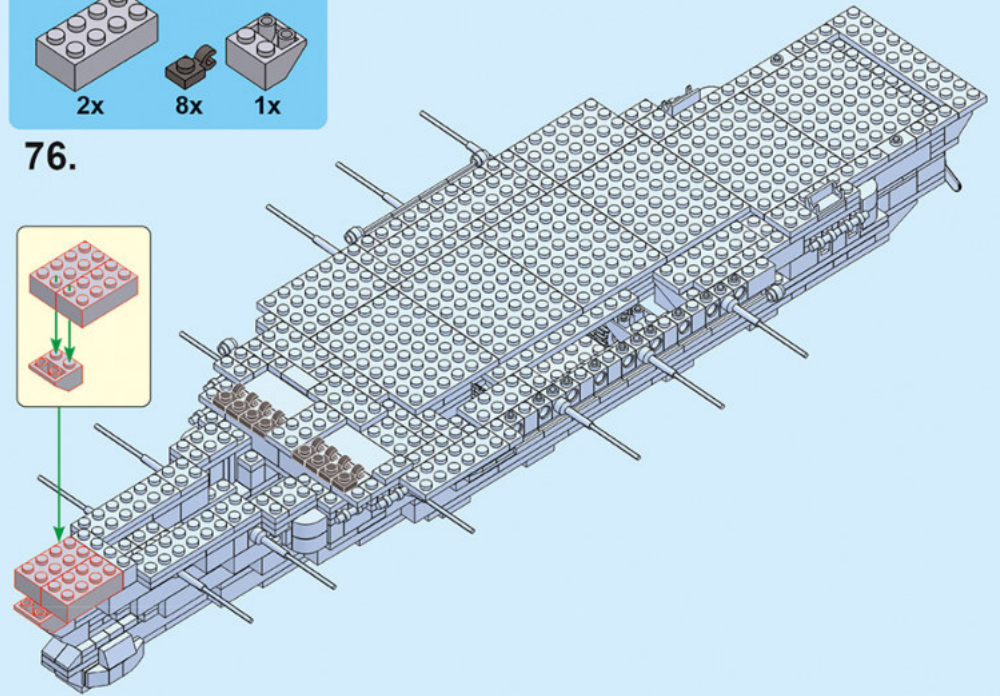
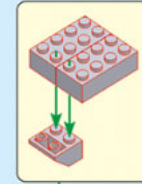

77.

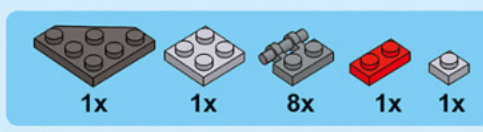
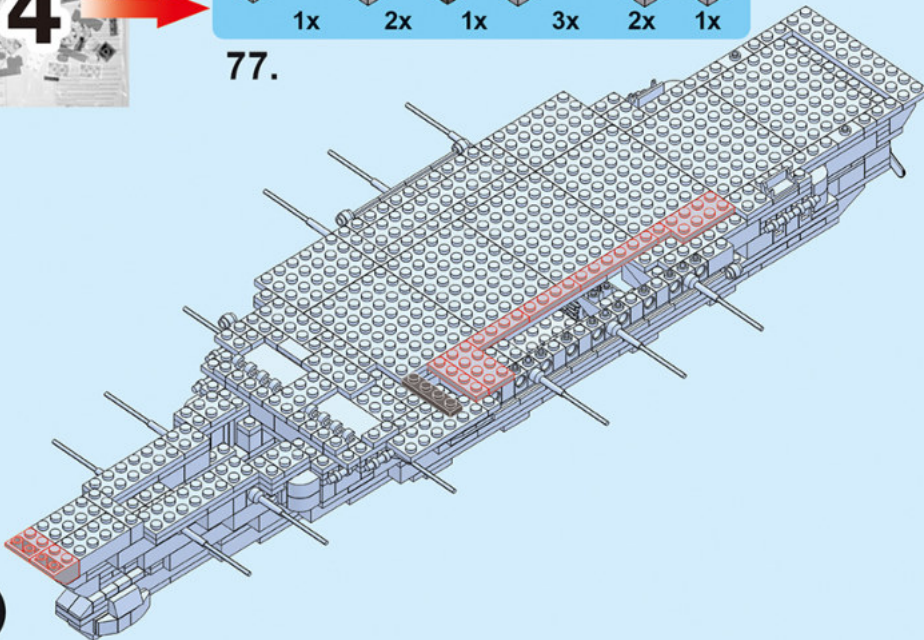

78.

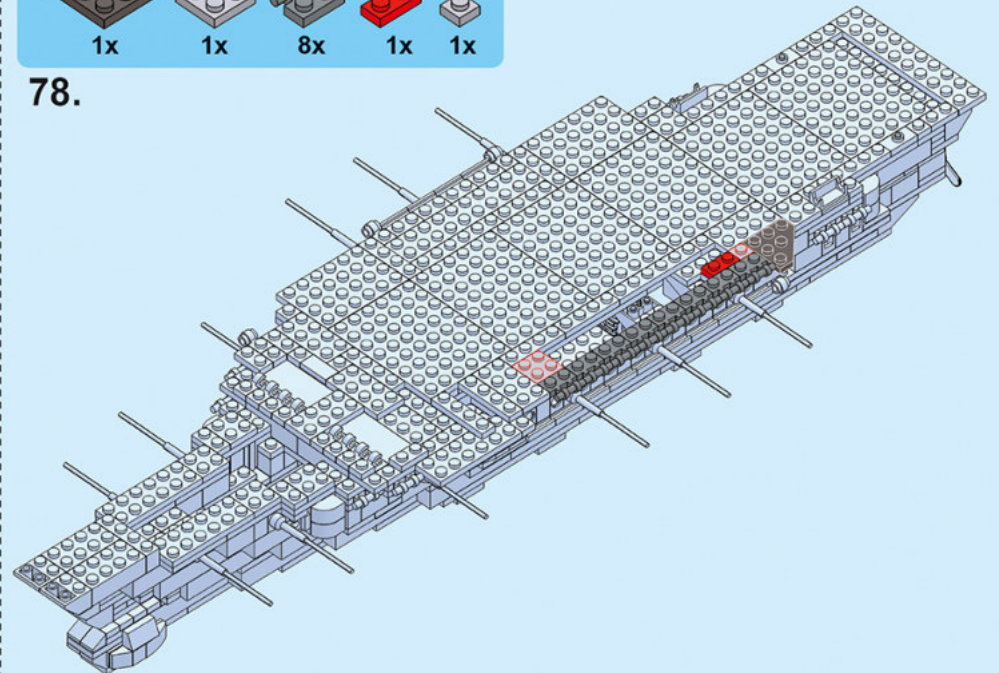

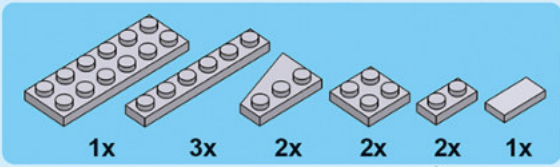

79.

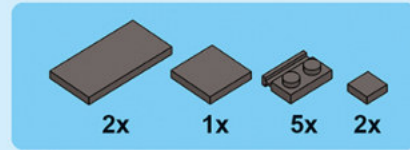
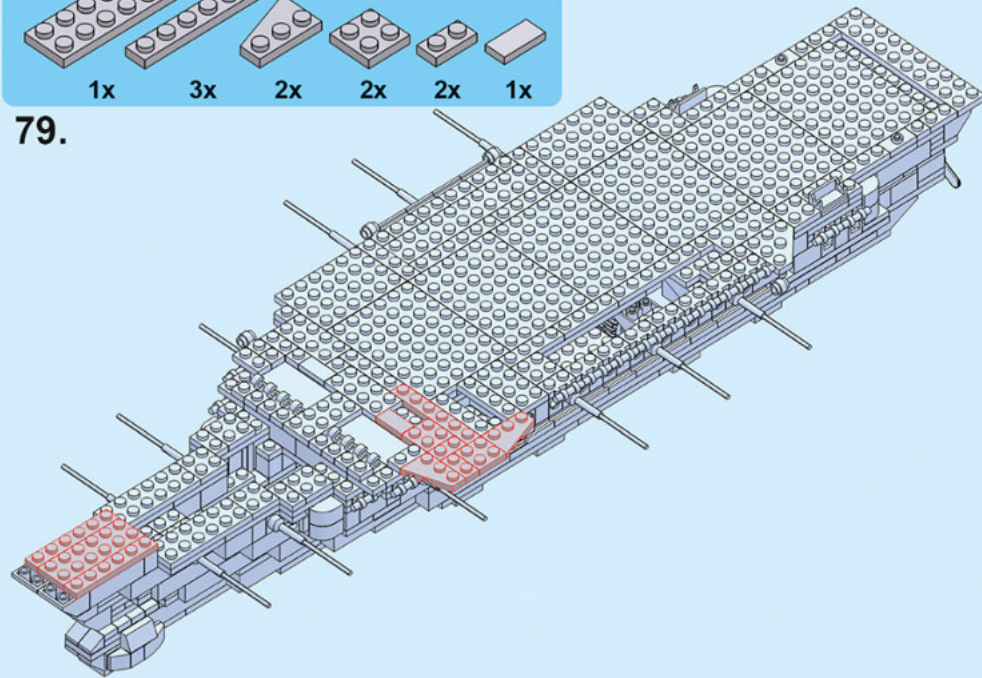

80.

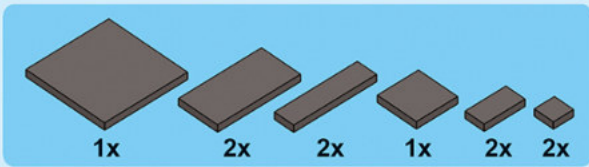
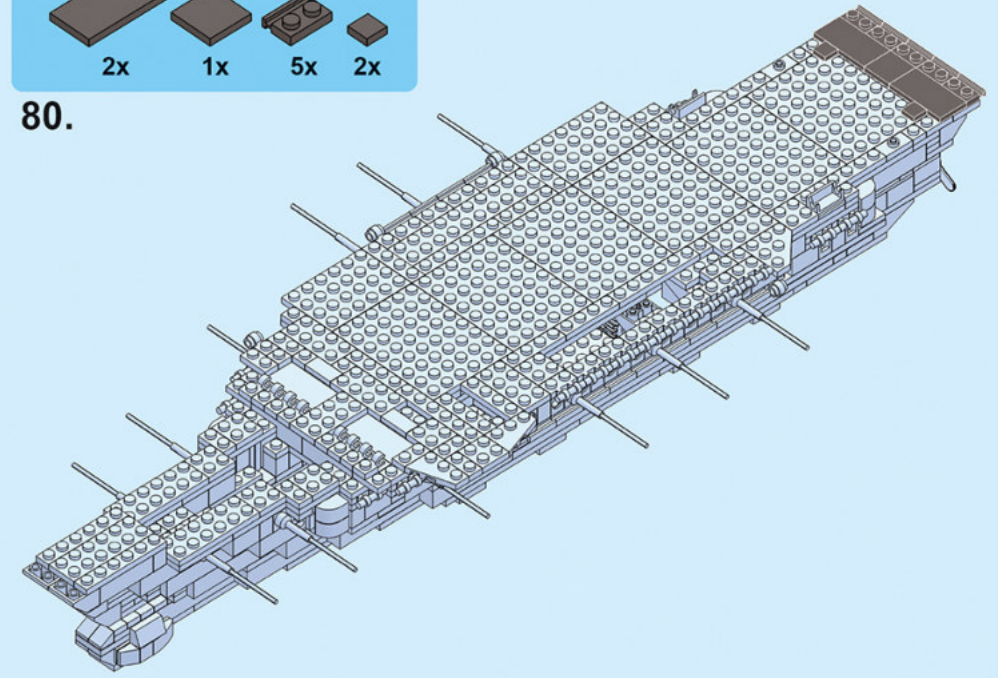

81.

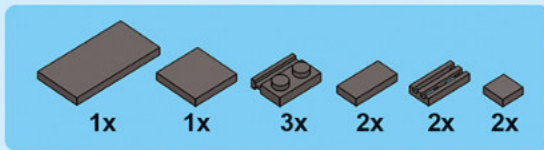
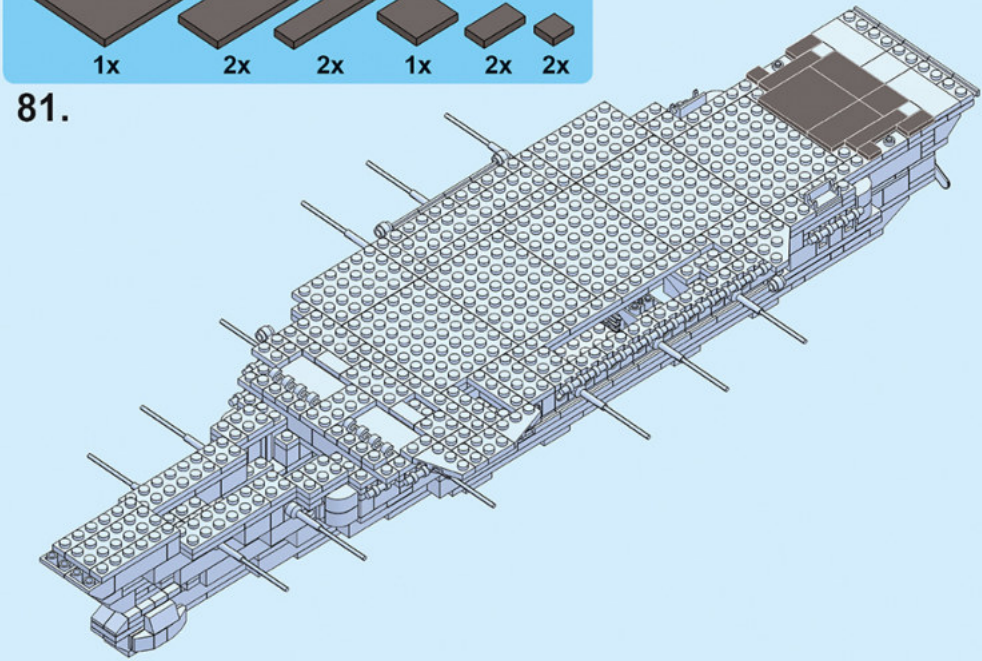

82.

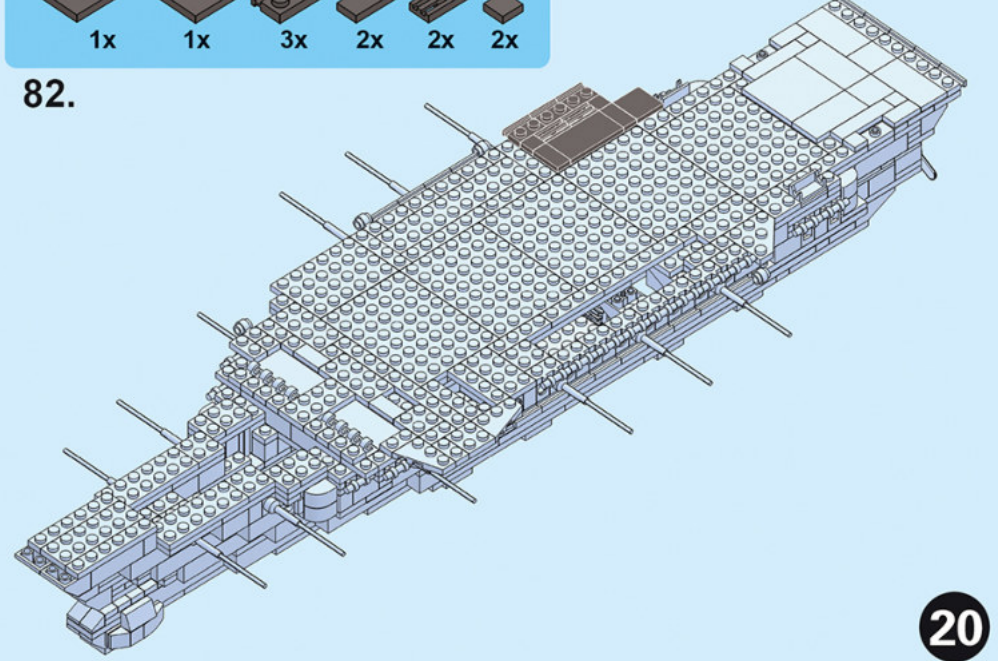

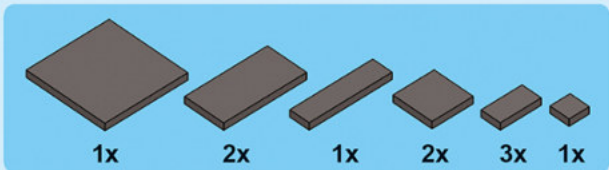

83.

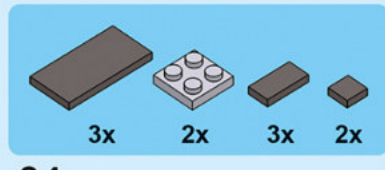
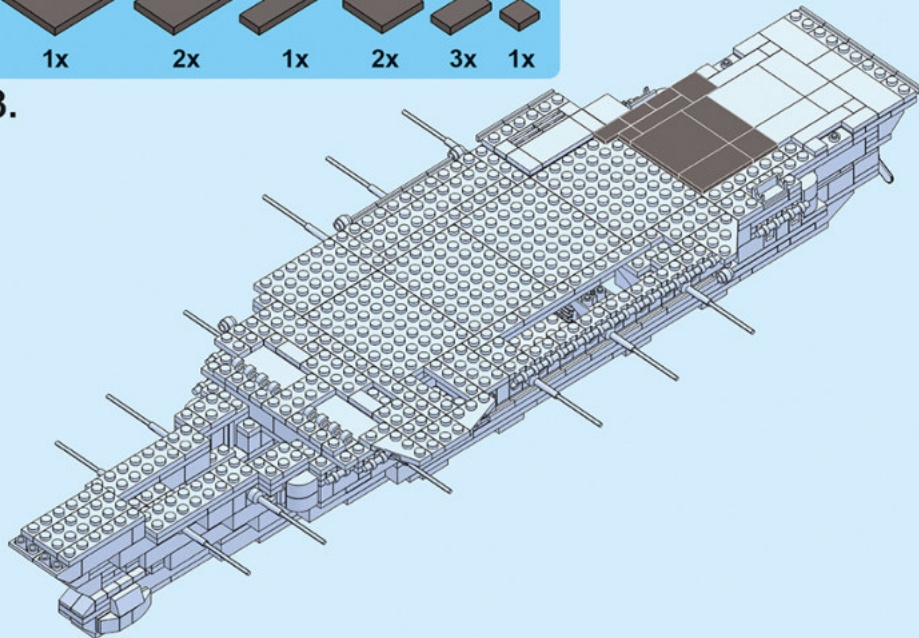

84.

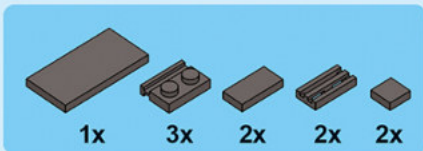
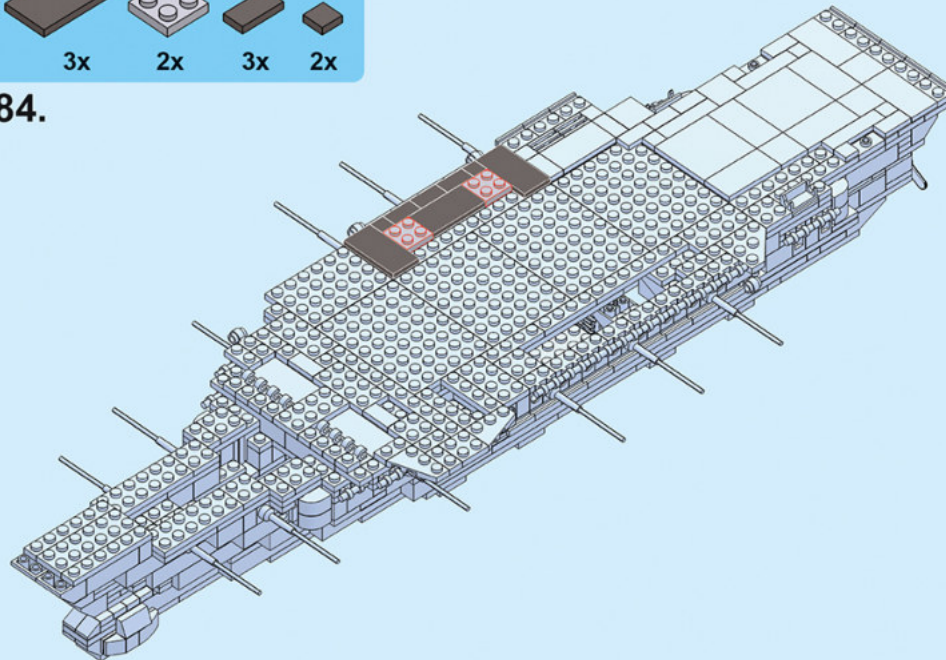

85.

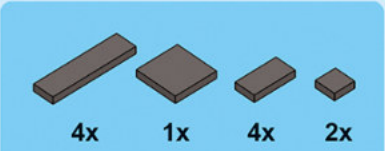
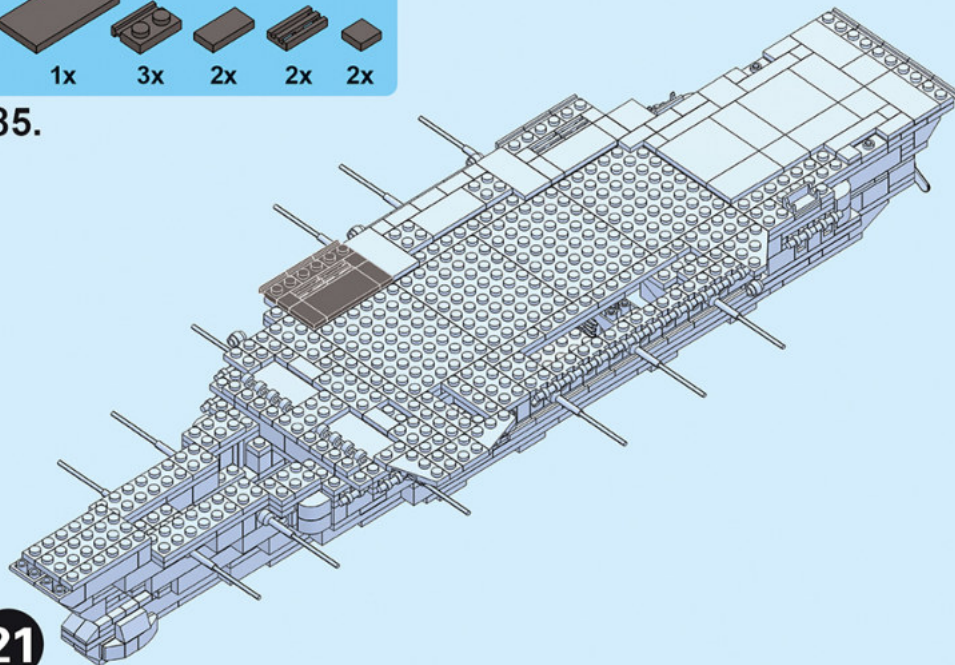

86.

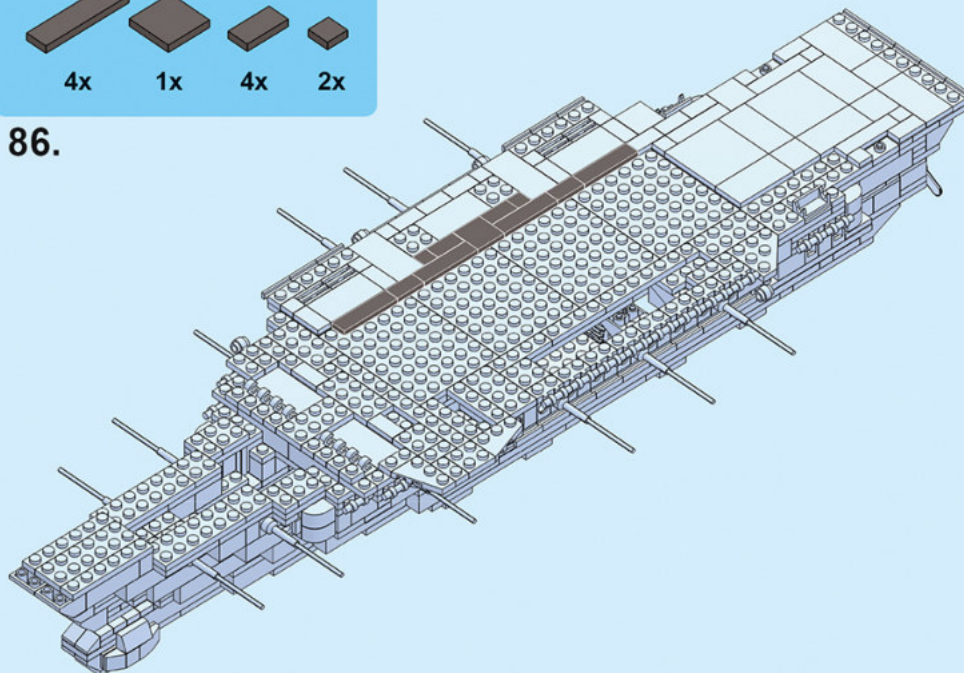

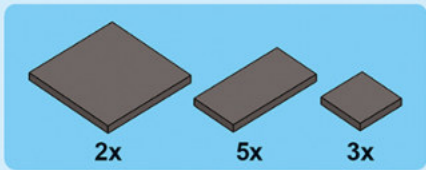

87.

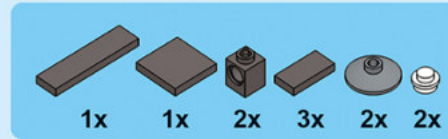
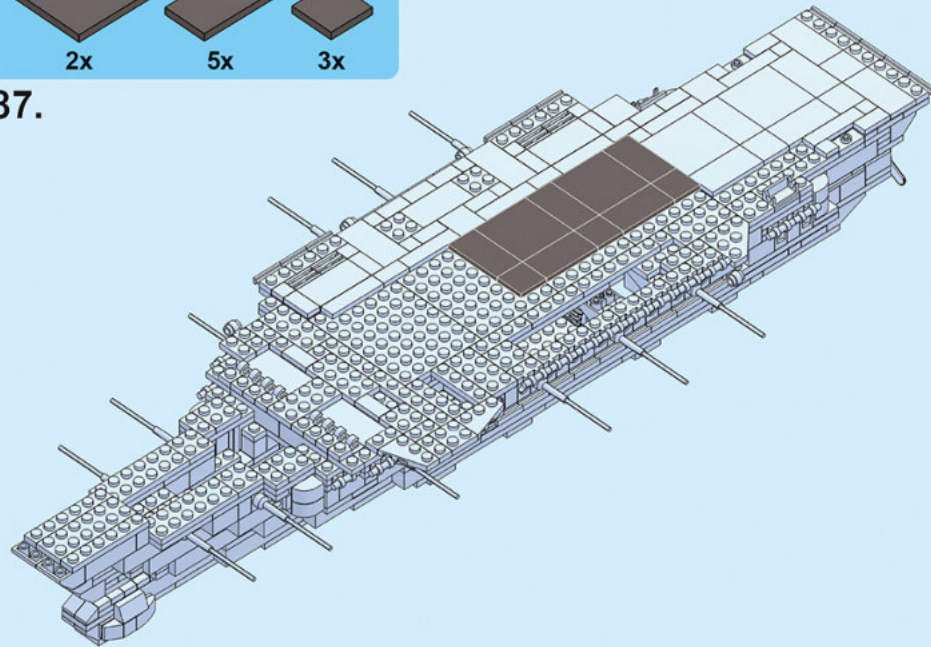

88.

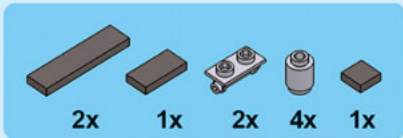
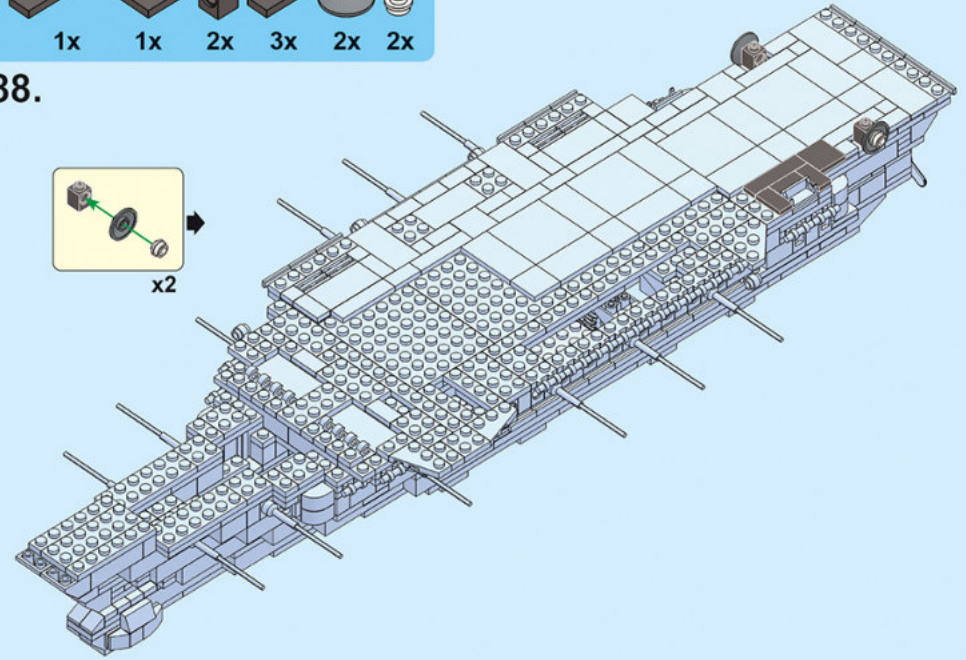
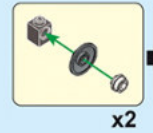

89.

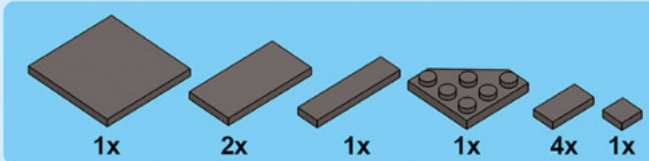
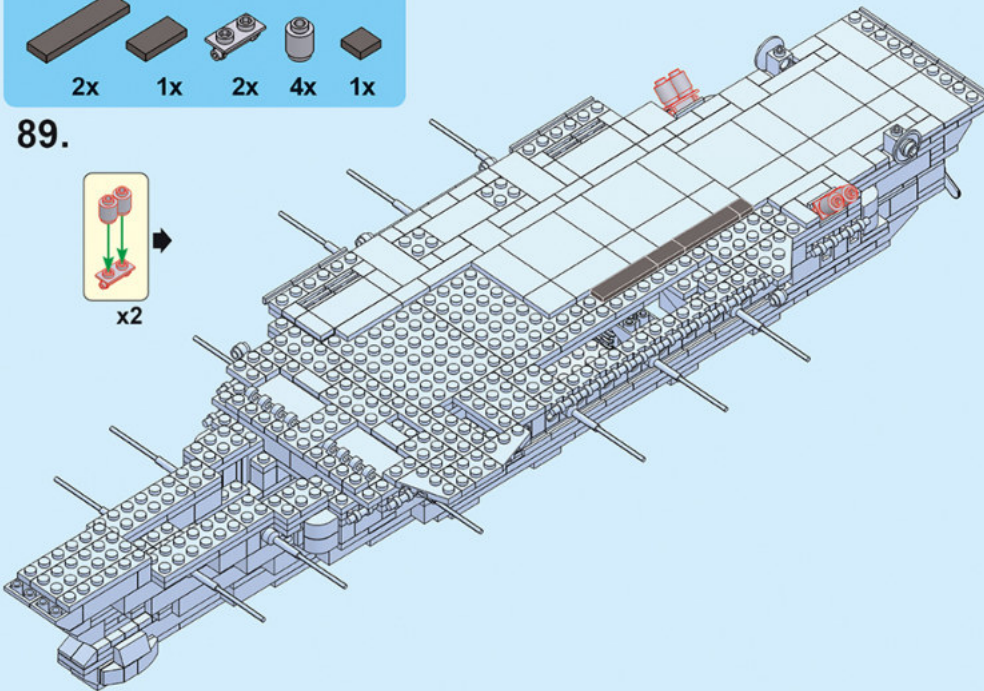
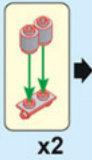

90.

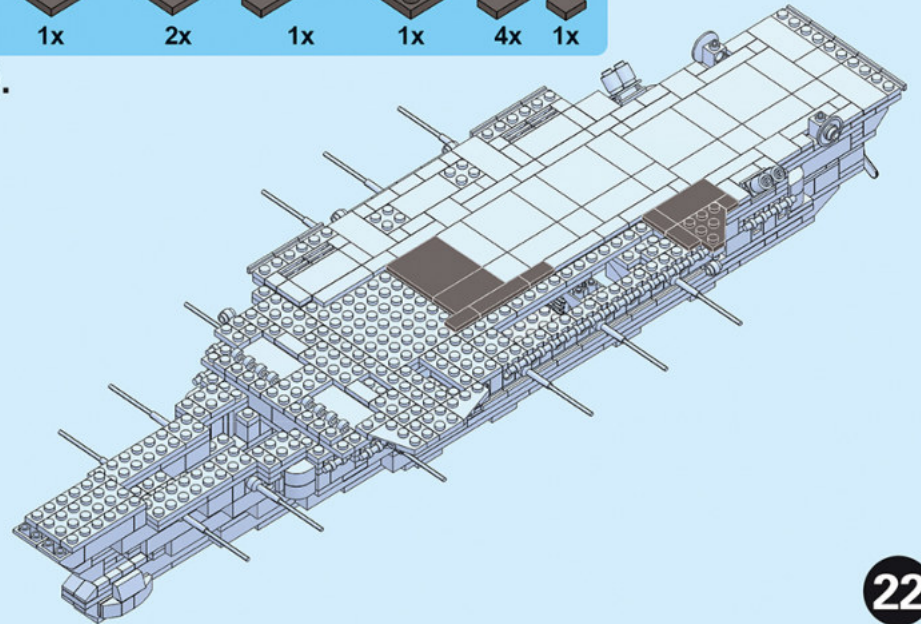

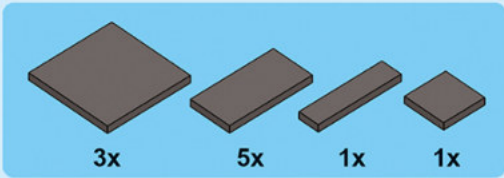

91.

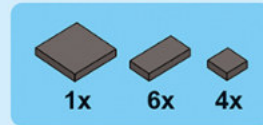
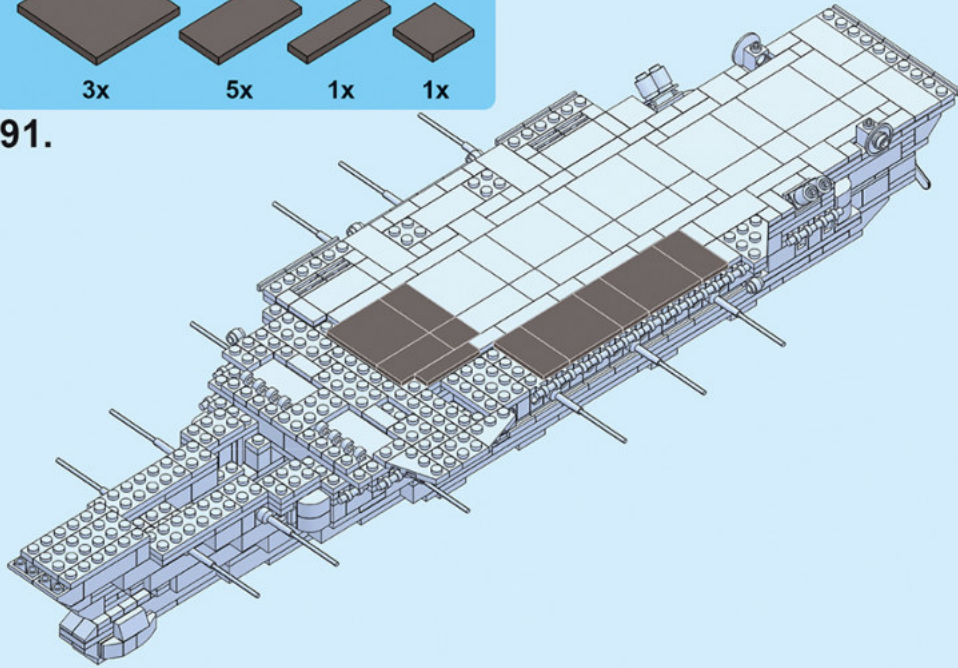

92.

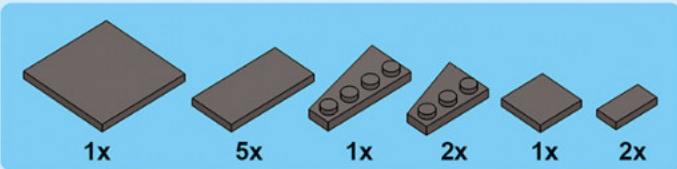
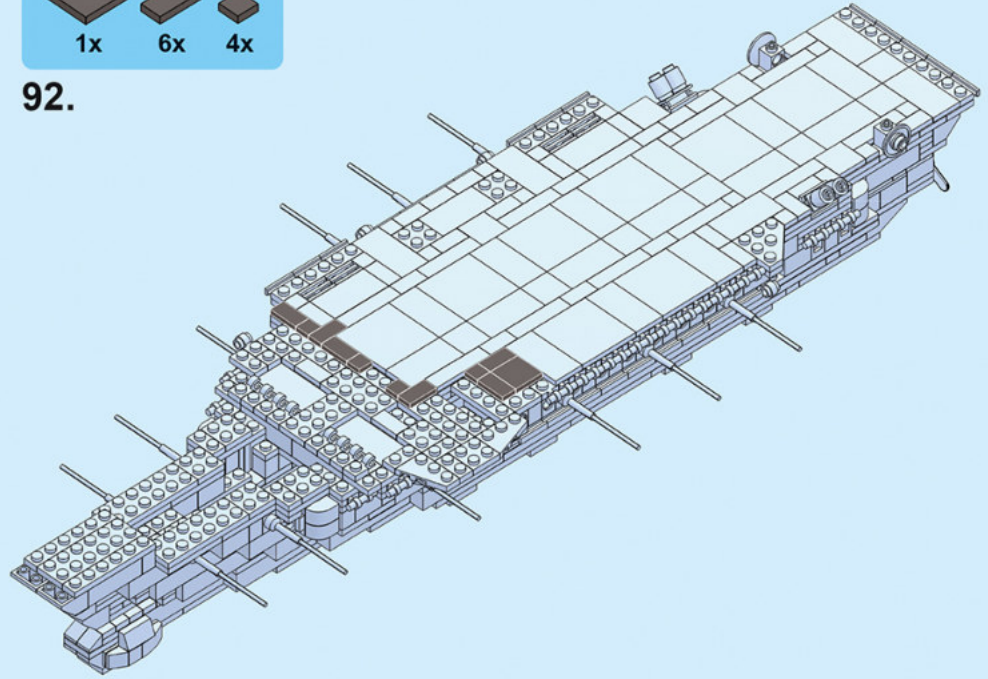

93.

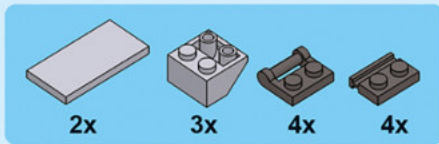
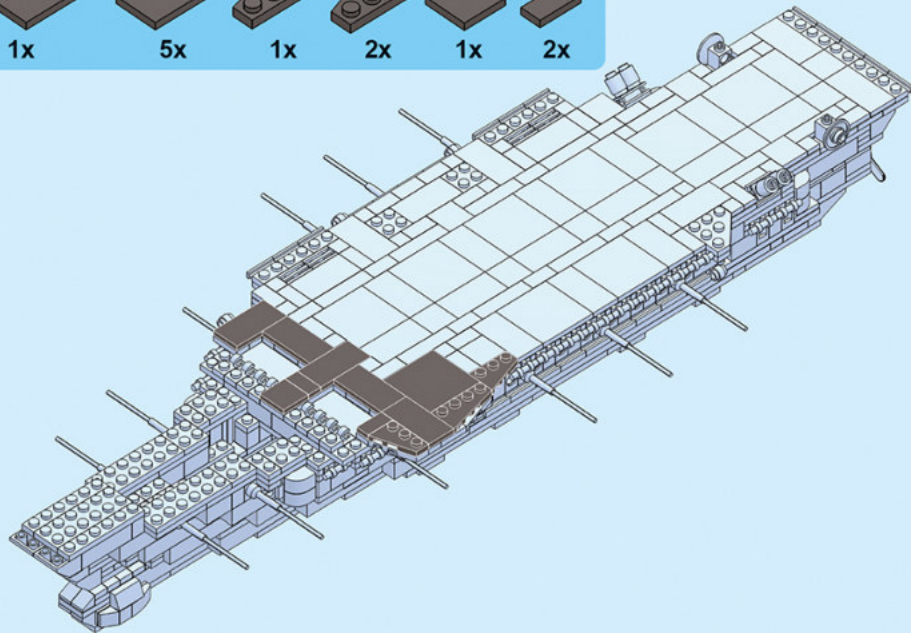

94.

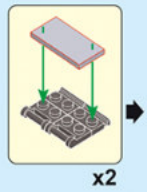
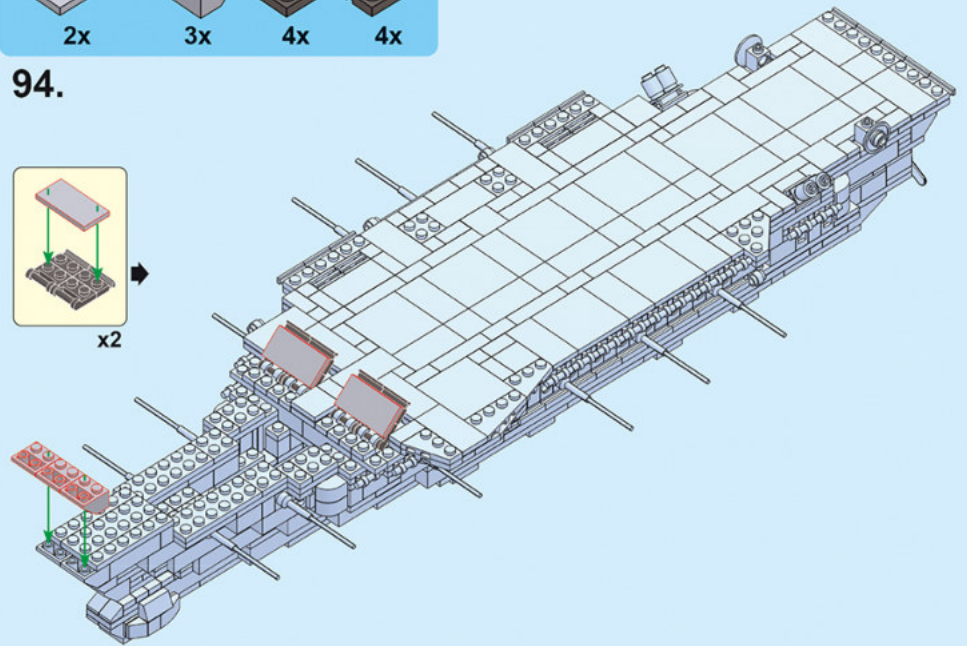

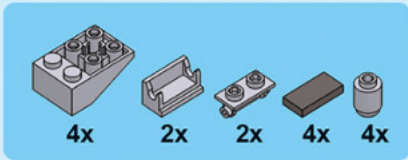

95.

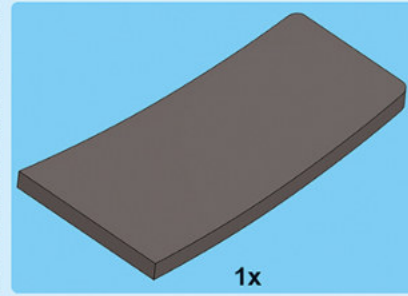
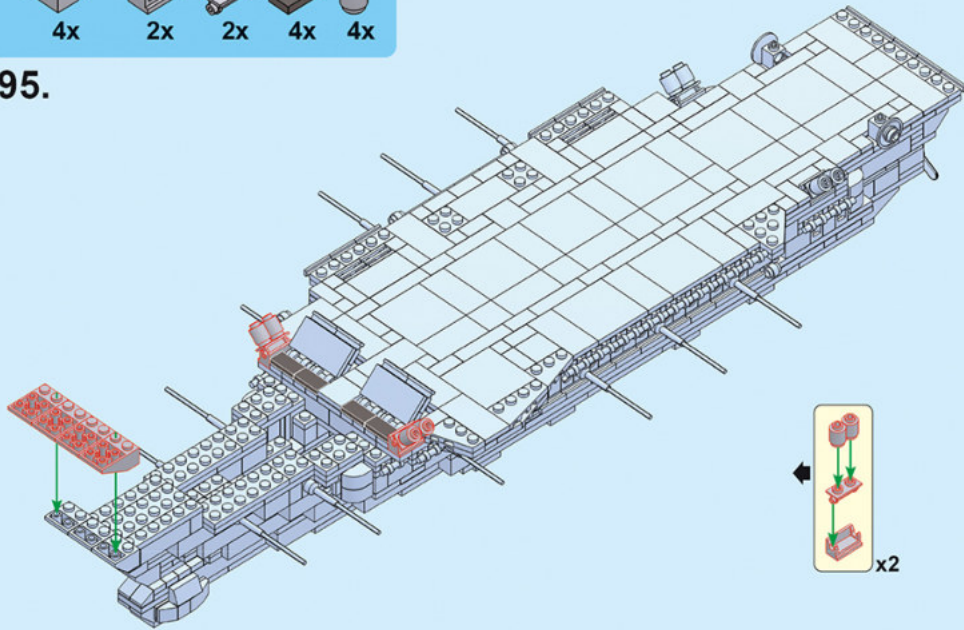

96.

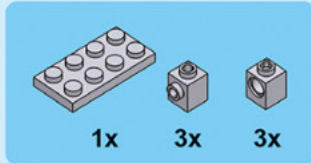
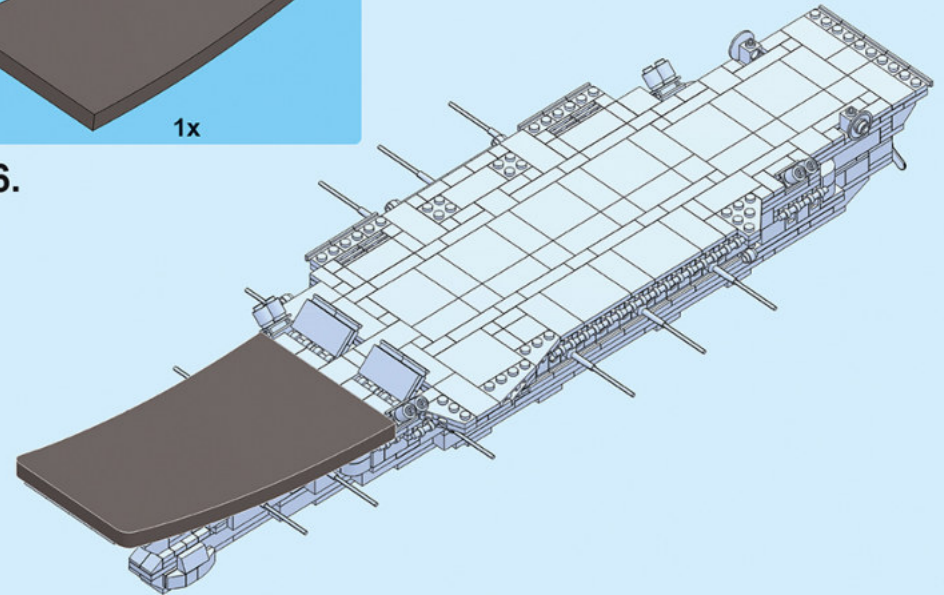

97.

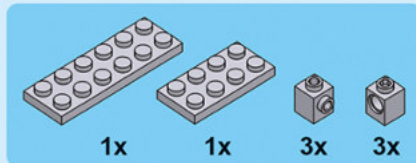
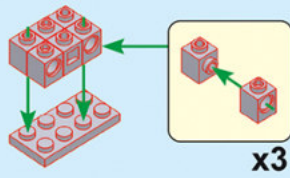

98.

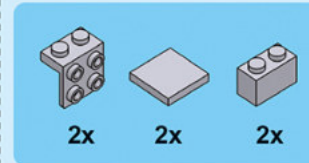
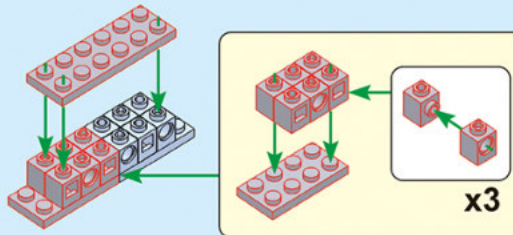

99.

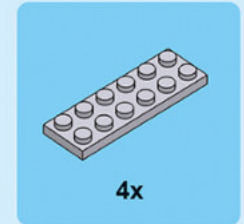
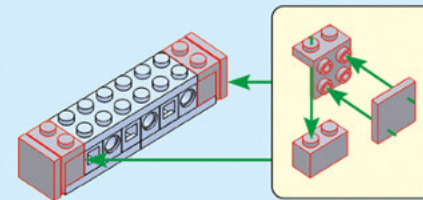

100.

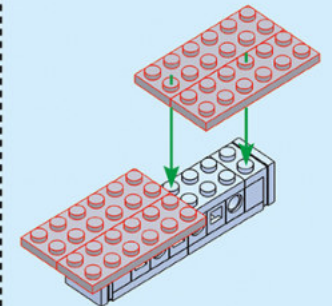

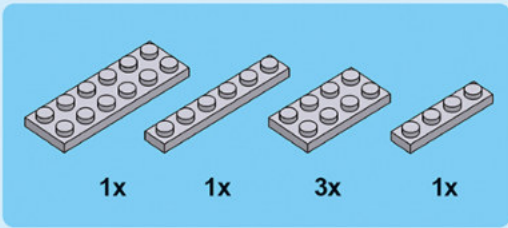

101.

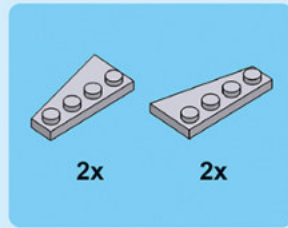
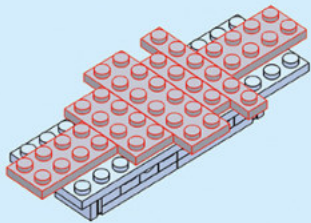

102.

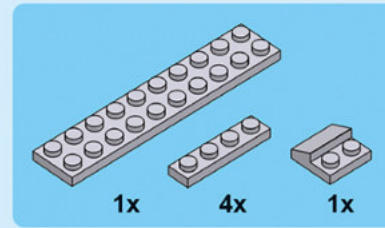
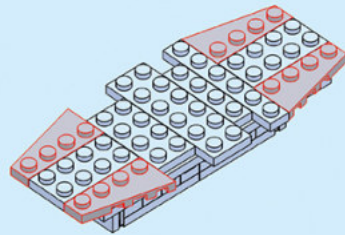

103.

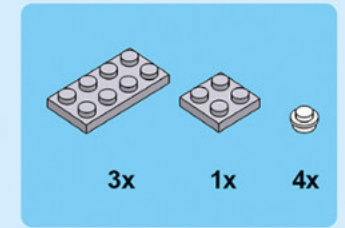
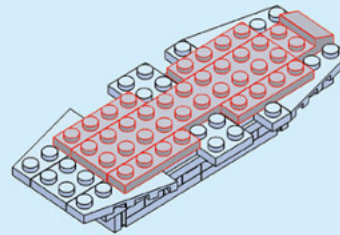

104.

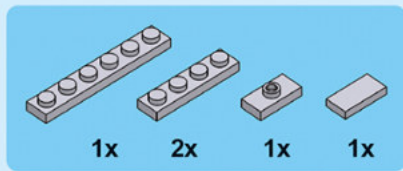
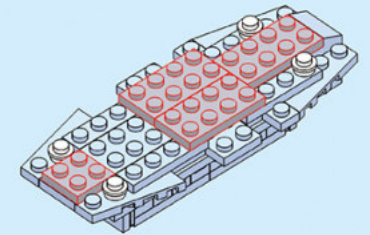

105.

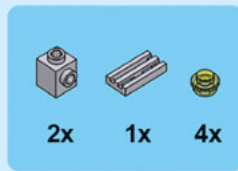
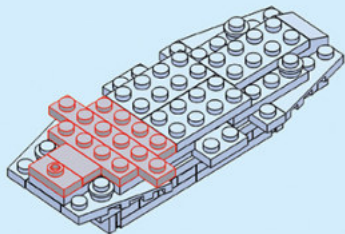

106.

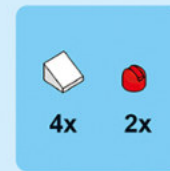
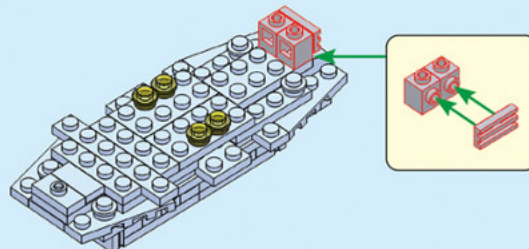

107.

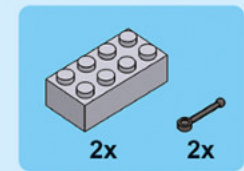
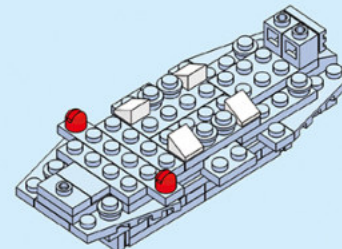

108.

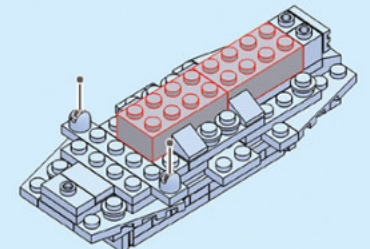

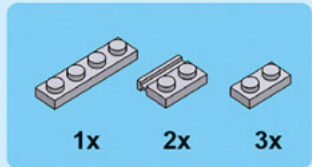

109.

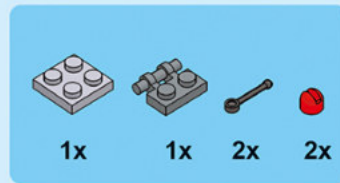
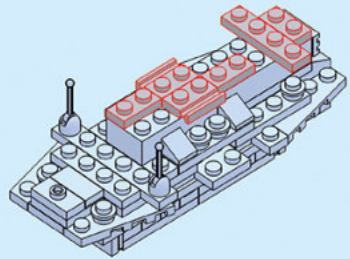

110.

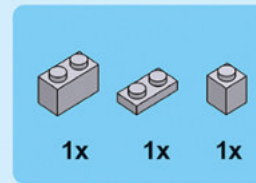
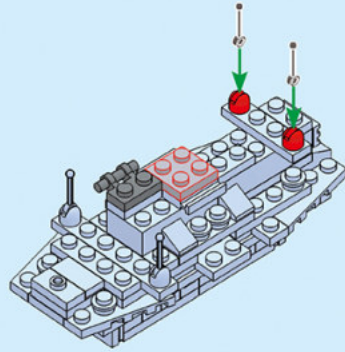

111.

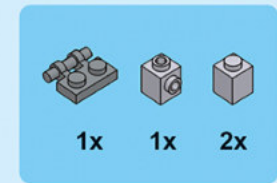
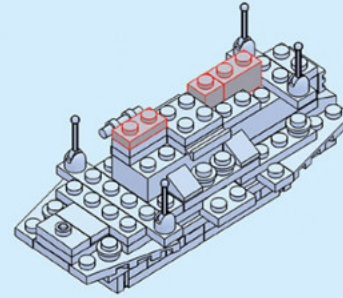

112.

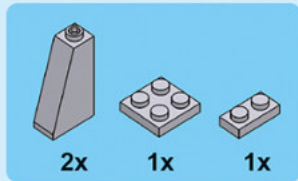
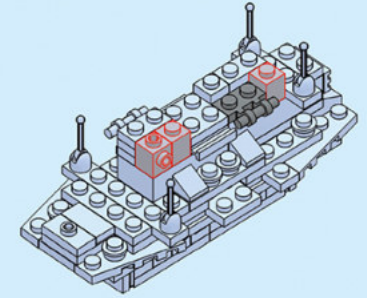

113.

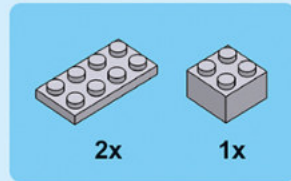
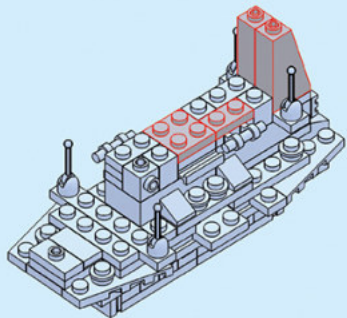

114.

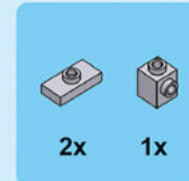
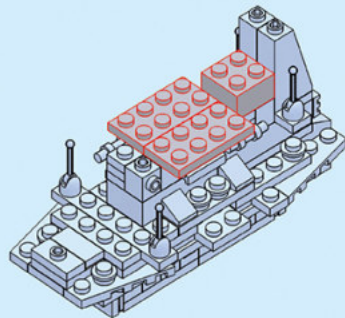

115.

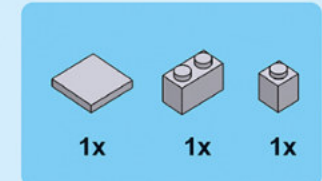
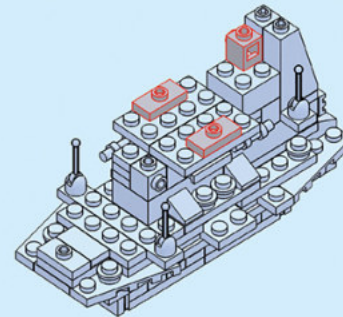

116.

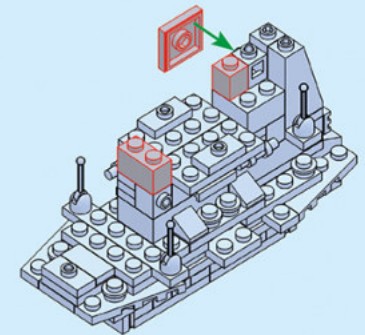

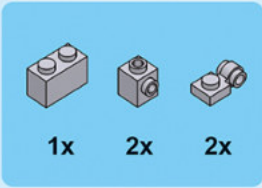

117.

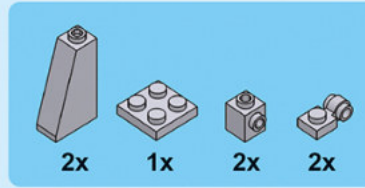
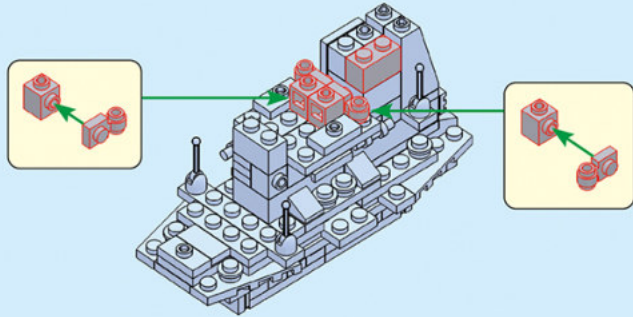

118.

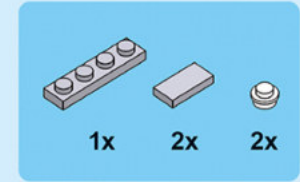
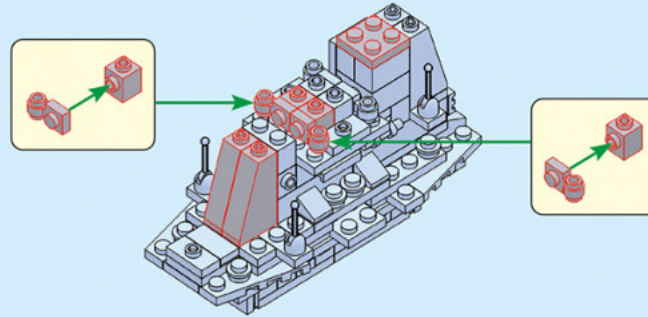

119.

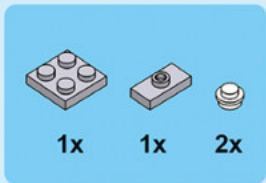
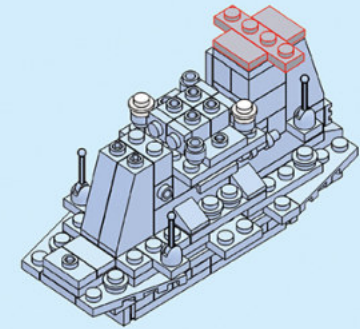

120.

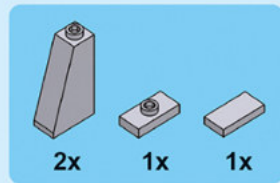
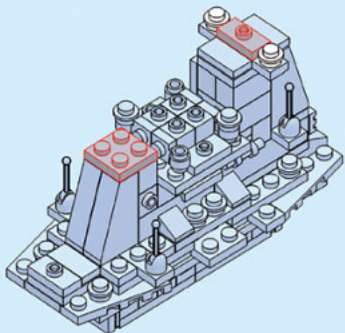

121.

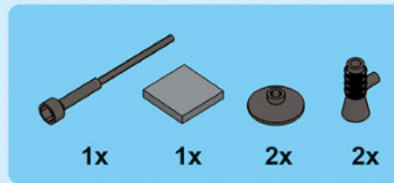
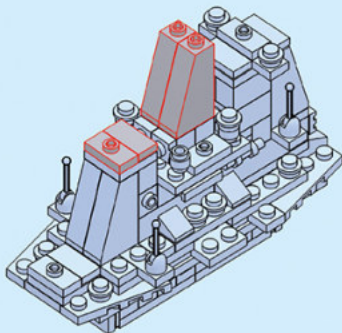

122.

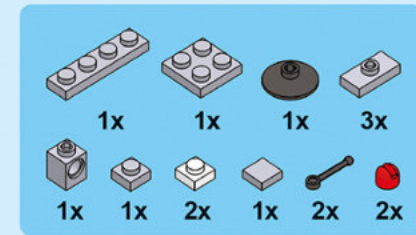
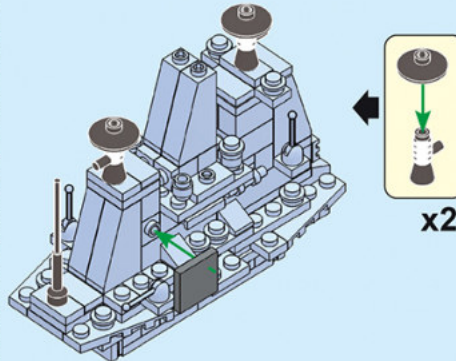

123.

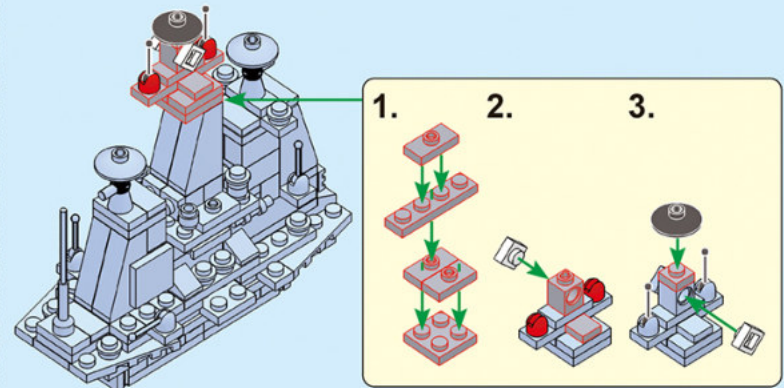

124.

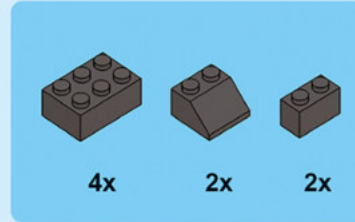
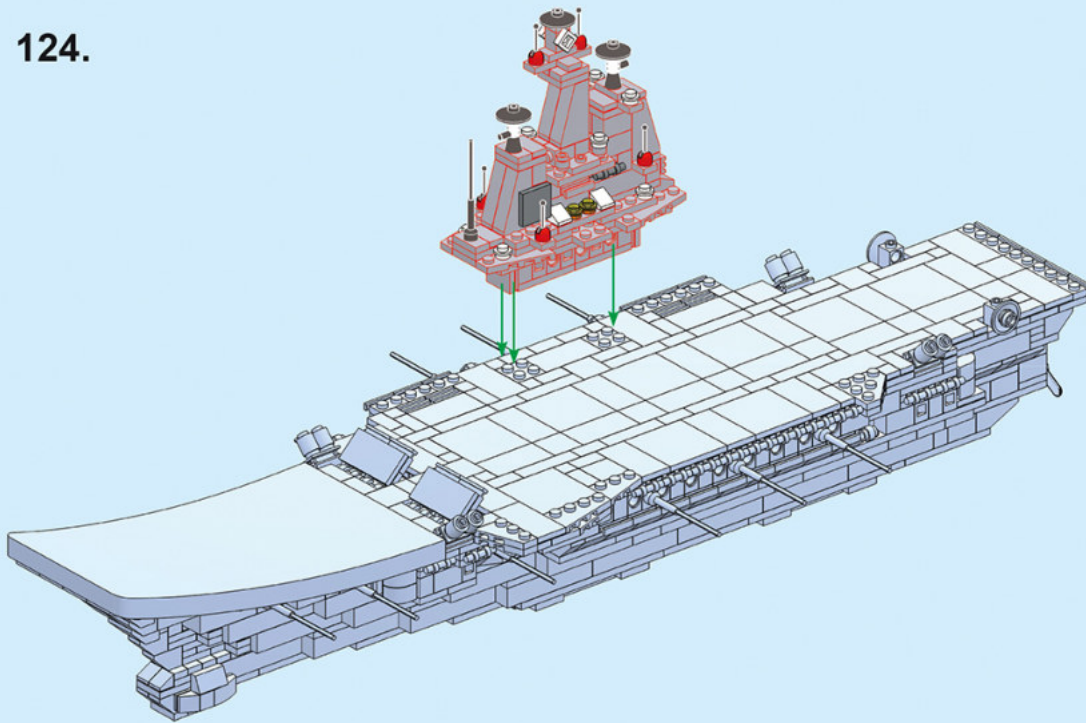

125.

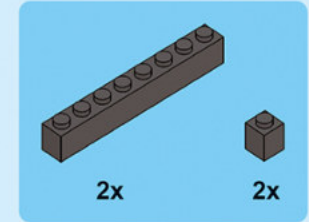
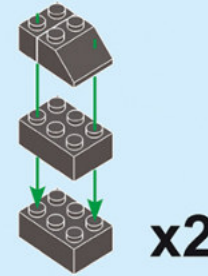

126.

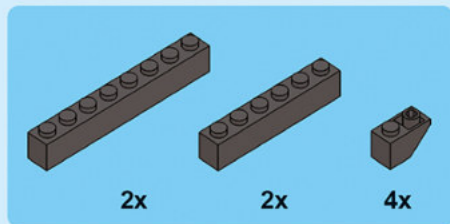
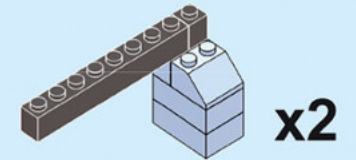

127.

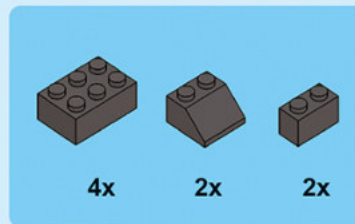
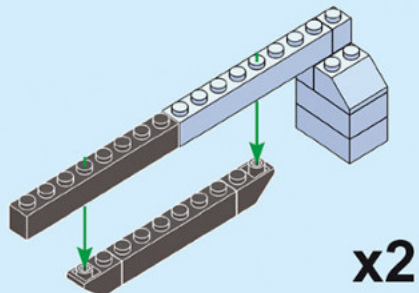

128.

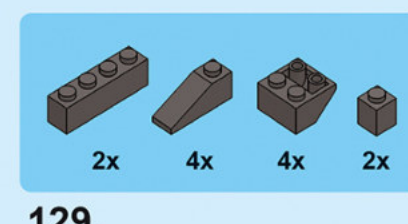
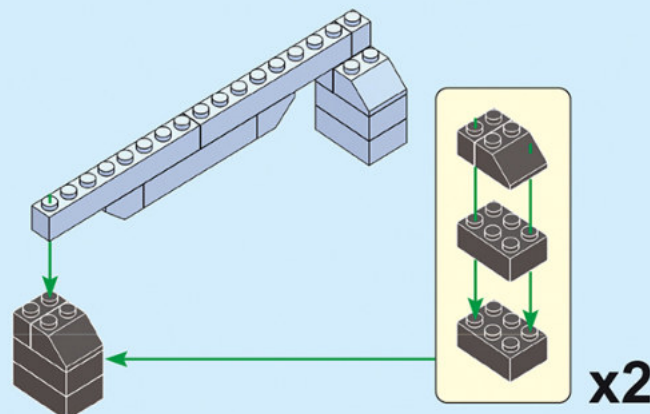

129.

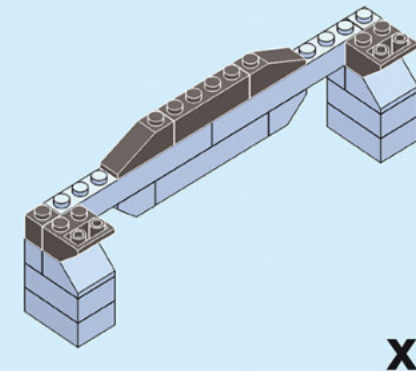

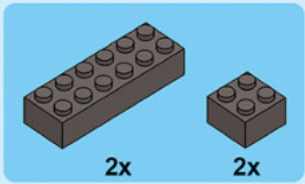

130.

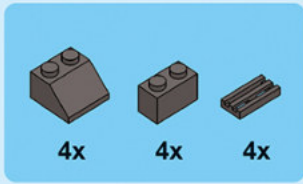
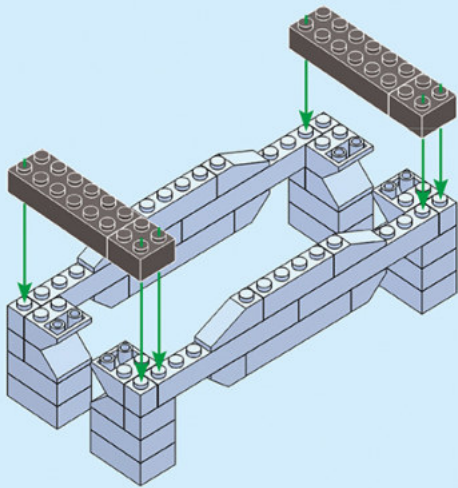

131.

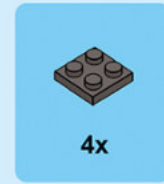
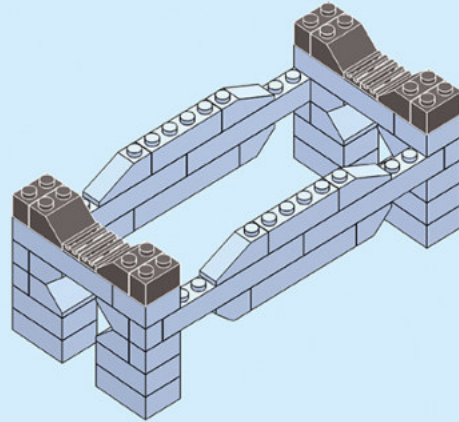

132.

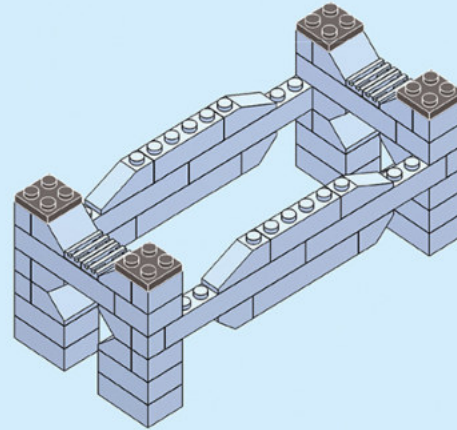

134.

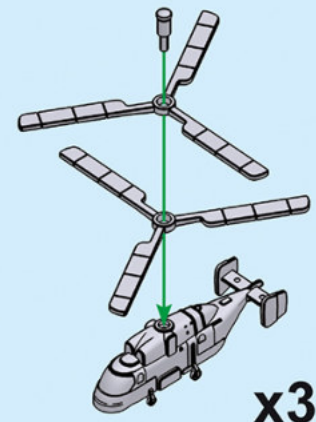
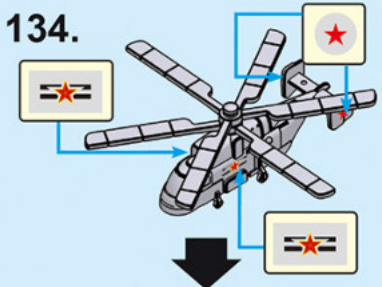

133.

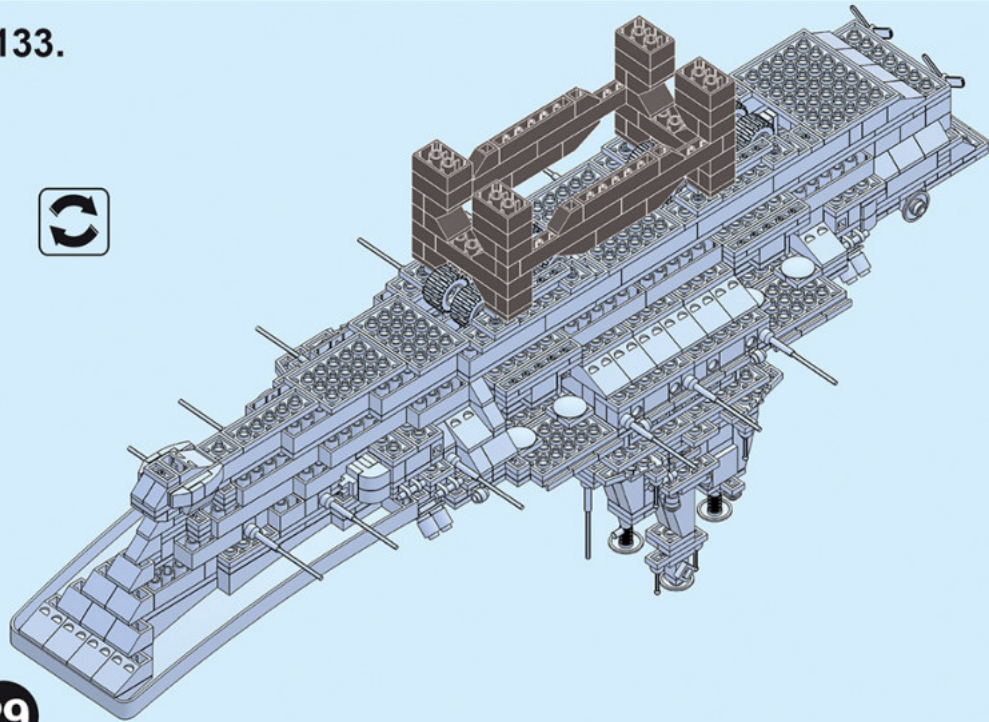

135.

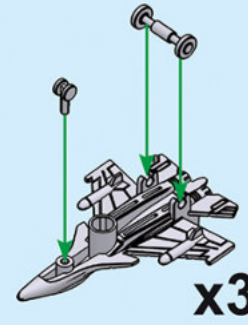
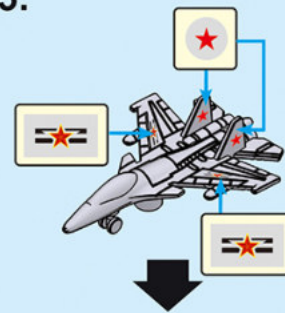

136.

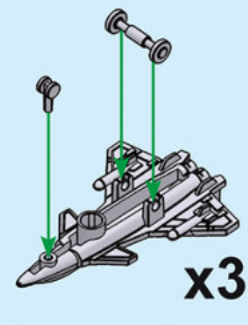
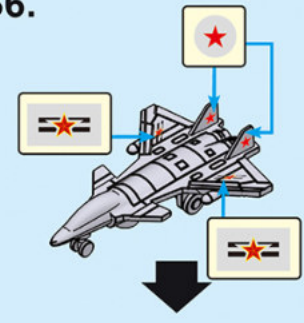



AIRCRAFT CARRIER

AGE: 6+



1:558



COMMAND CENTER



AIRFIELD DECK



READY TO TAKE OFF



LANDING DECK



AIRCRAFT TAKE-OFF