

2.

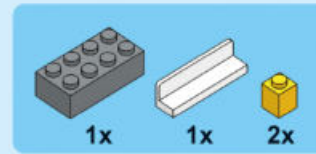

3.

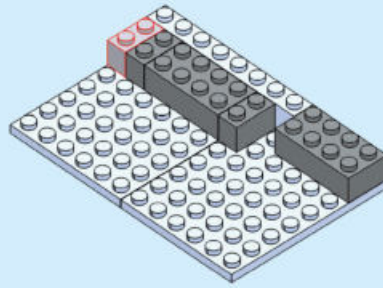
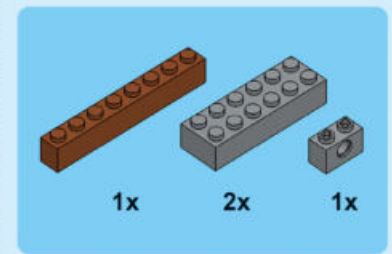
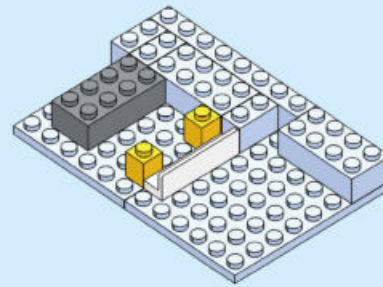

4.

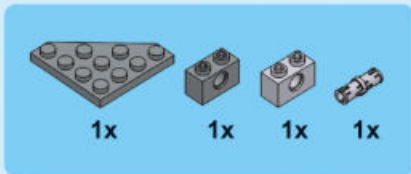
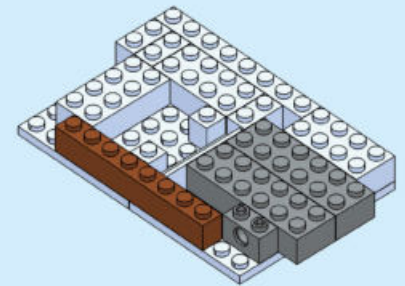

5.

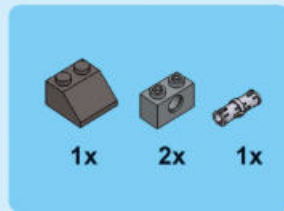
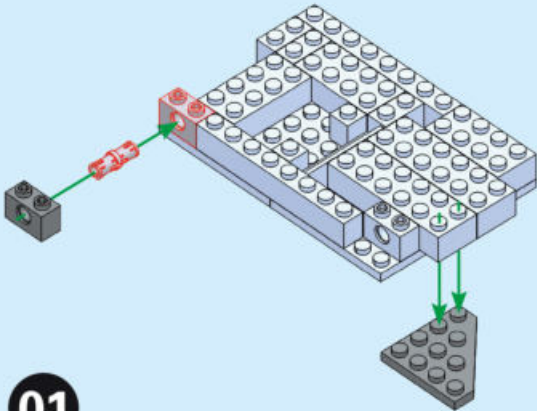

6.

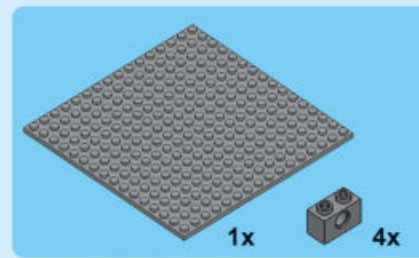
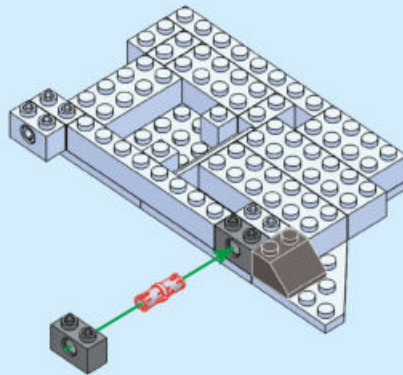

7.

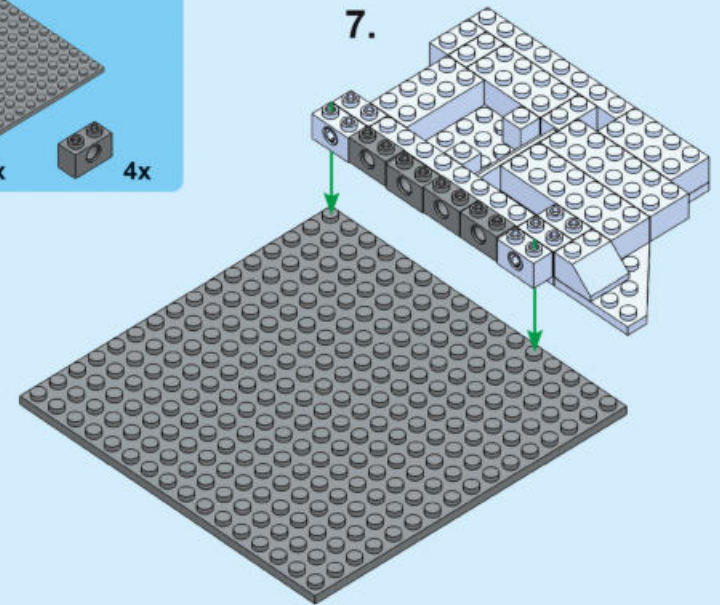



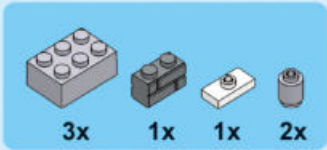

8.

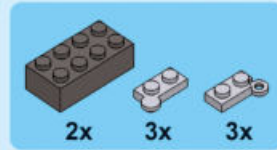
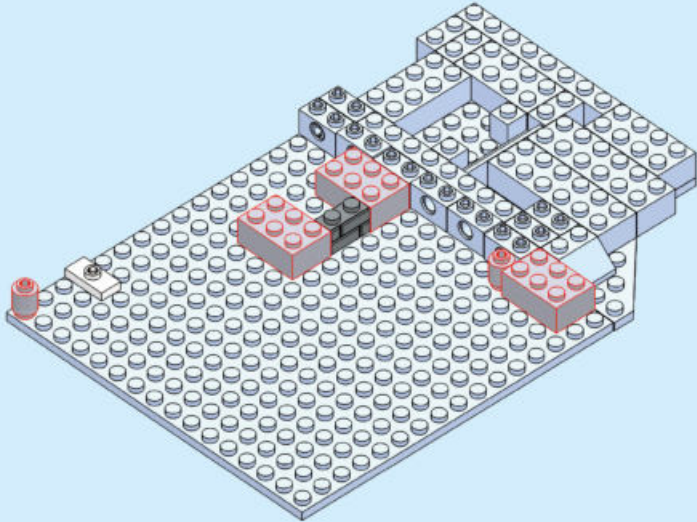

9.

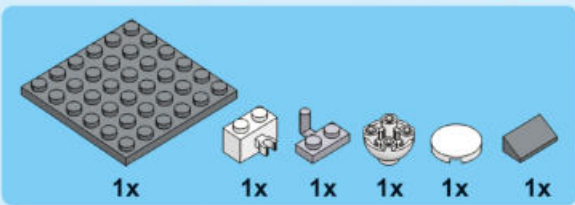
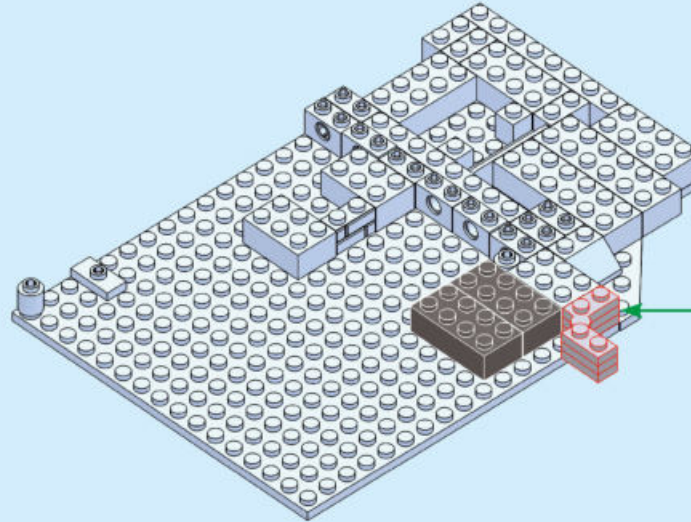

10.

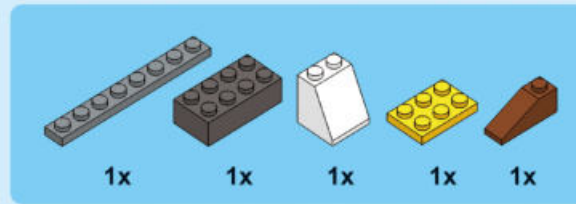
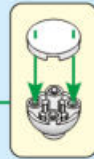
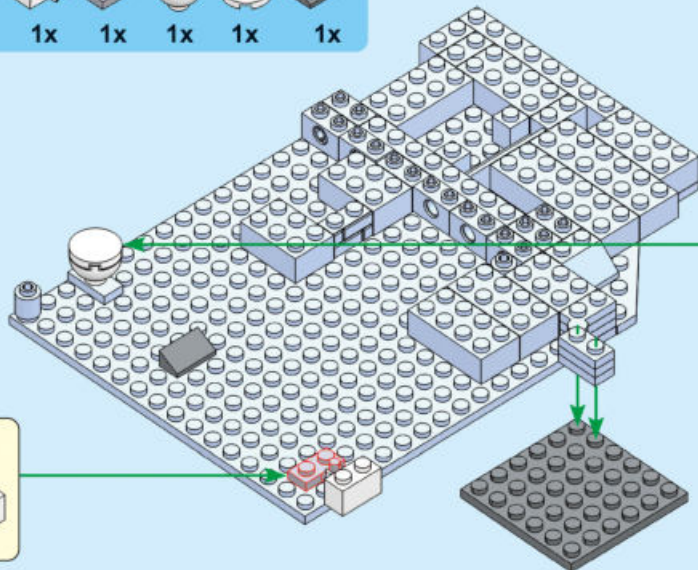

11.

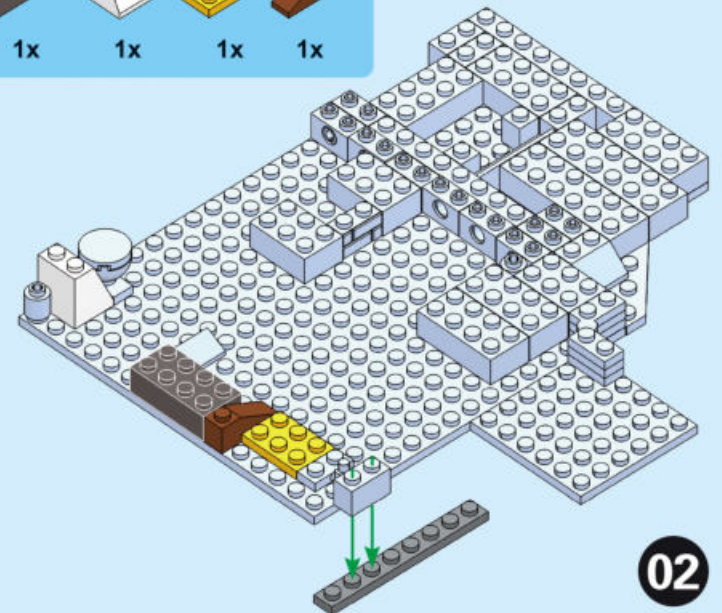



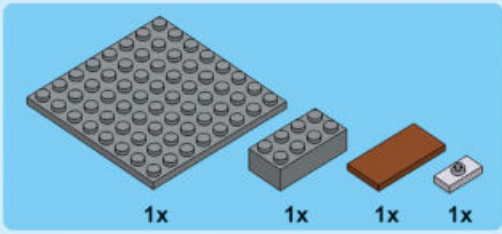

12.

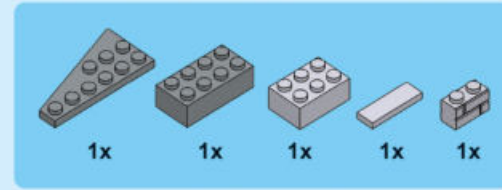
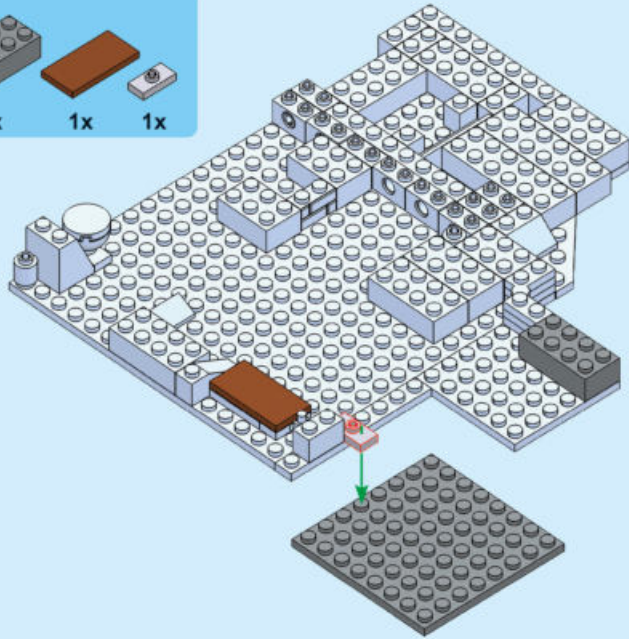

13.

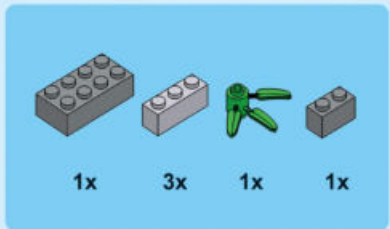
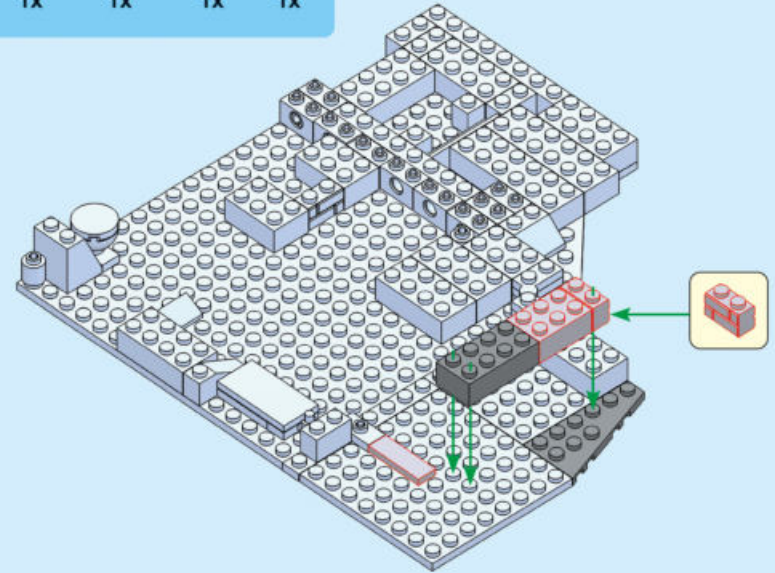

14.

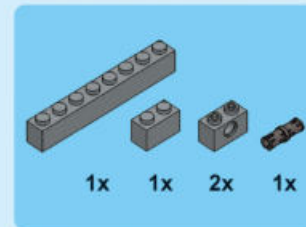
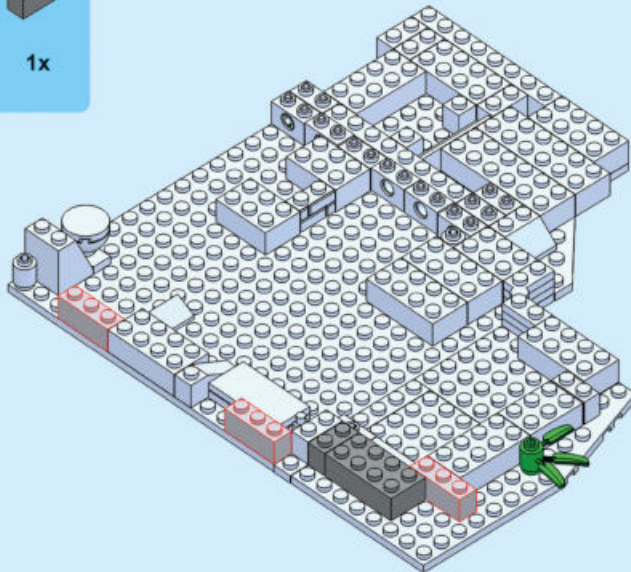

15.

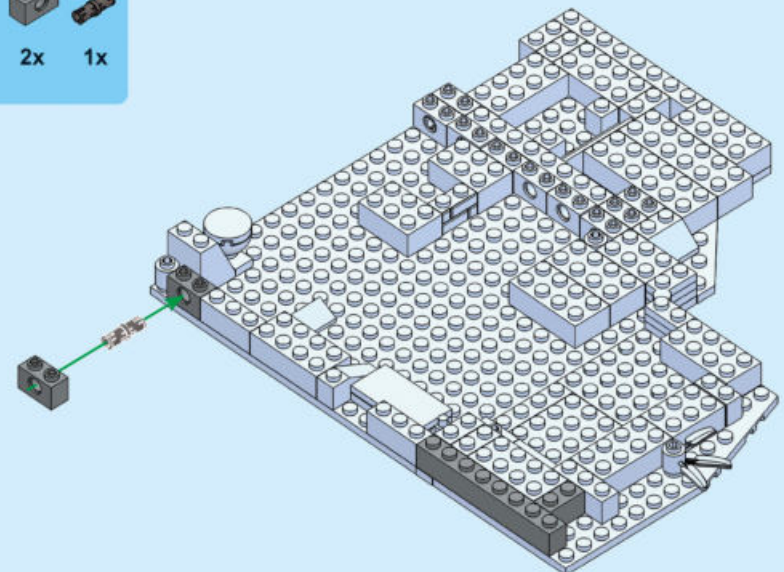



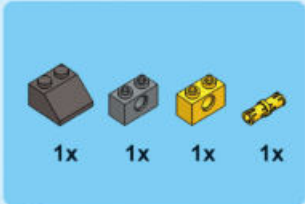

16.

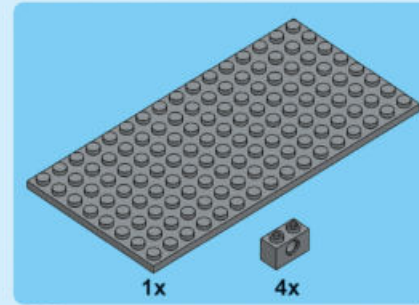
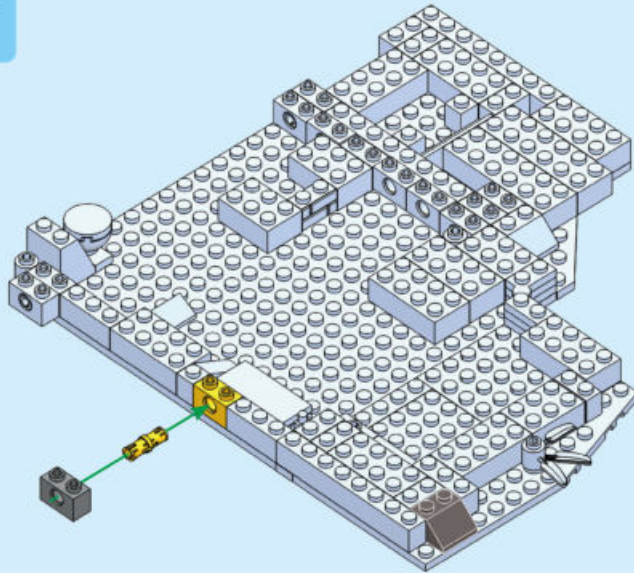

17.

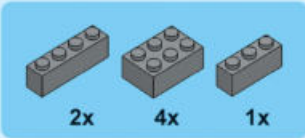
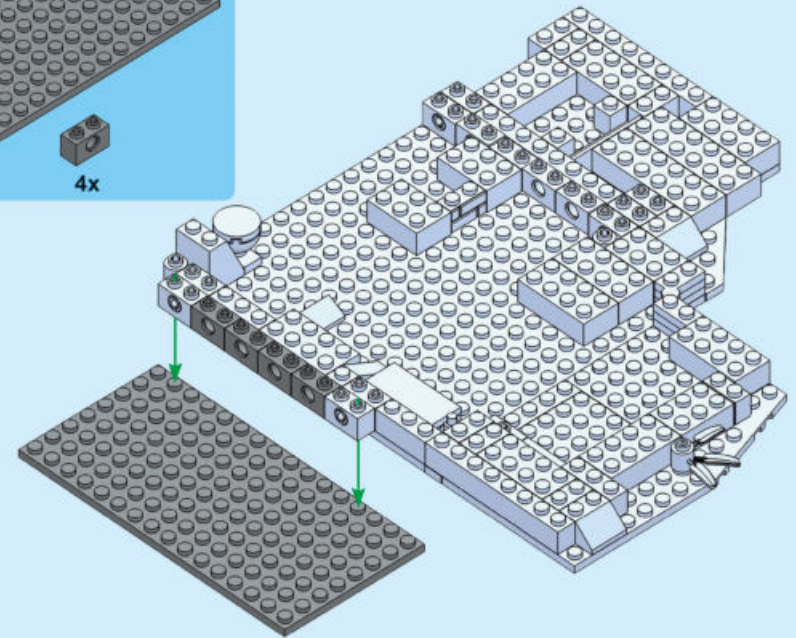

18.

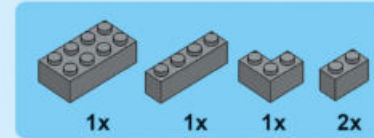
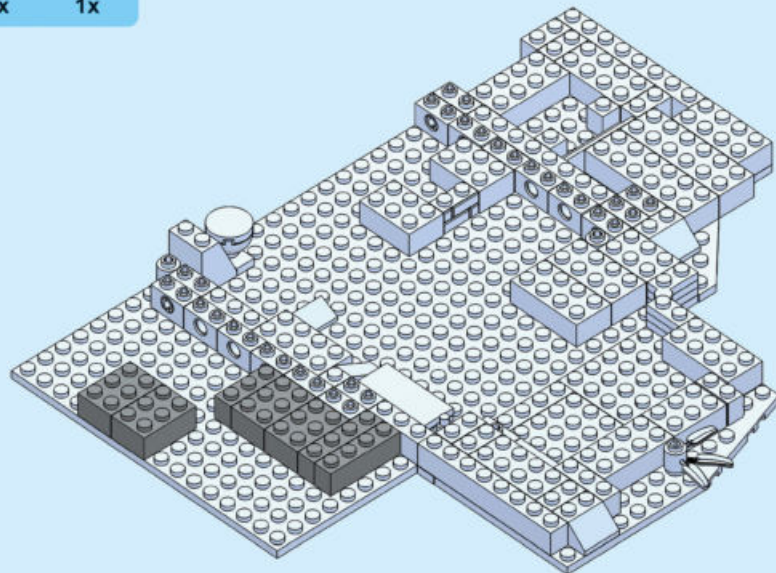

19.

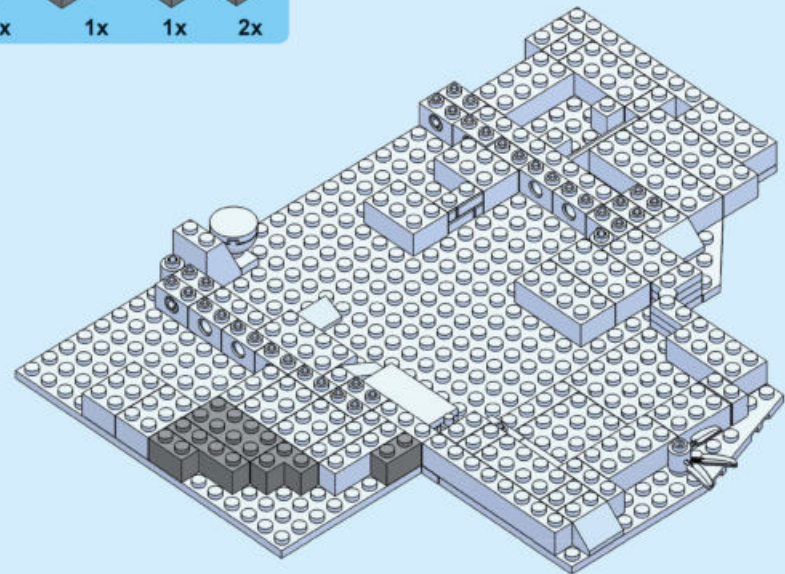



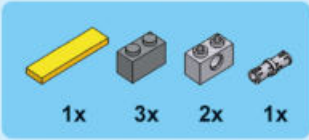

20.

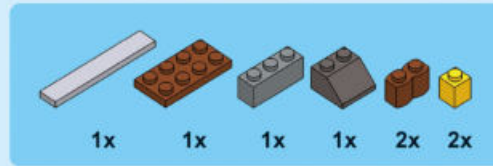
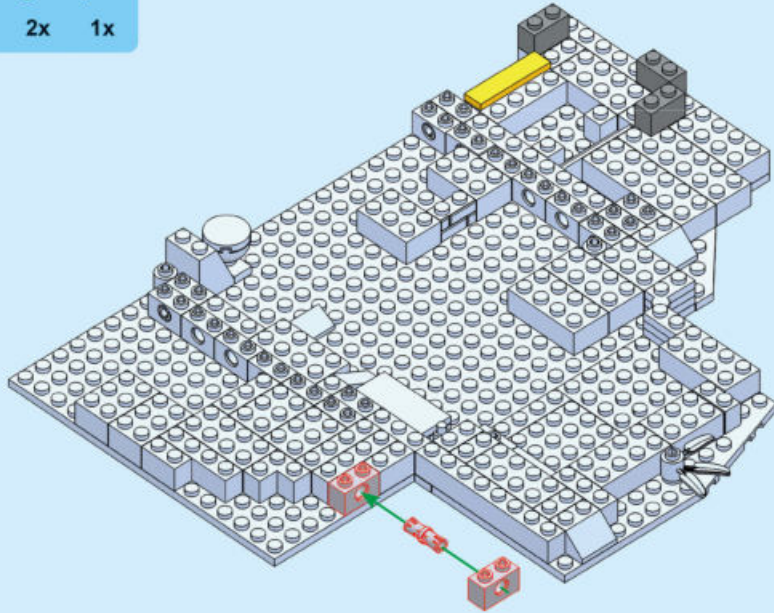

21.

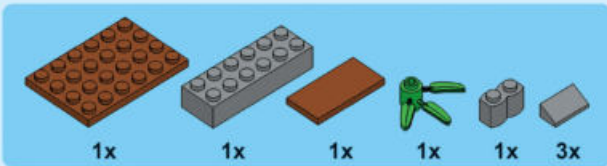
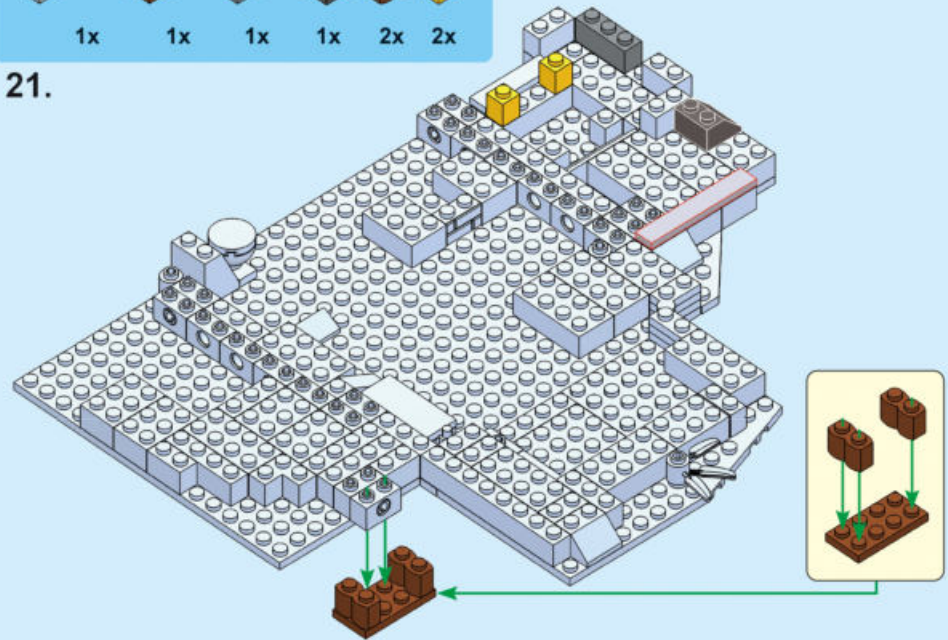

22.

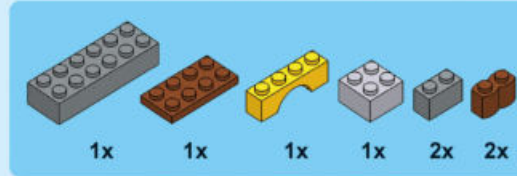
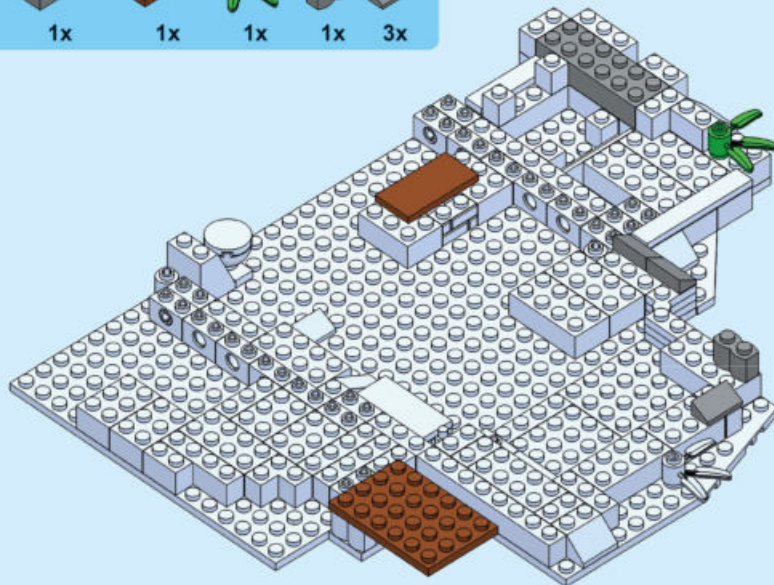

23.

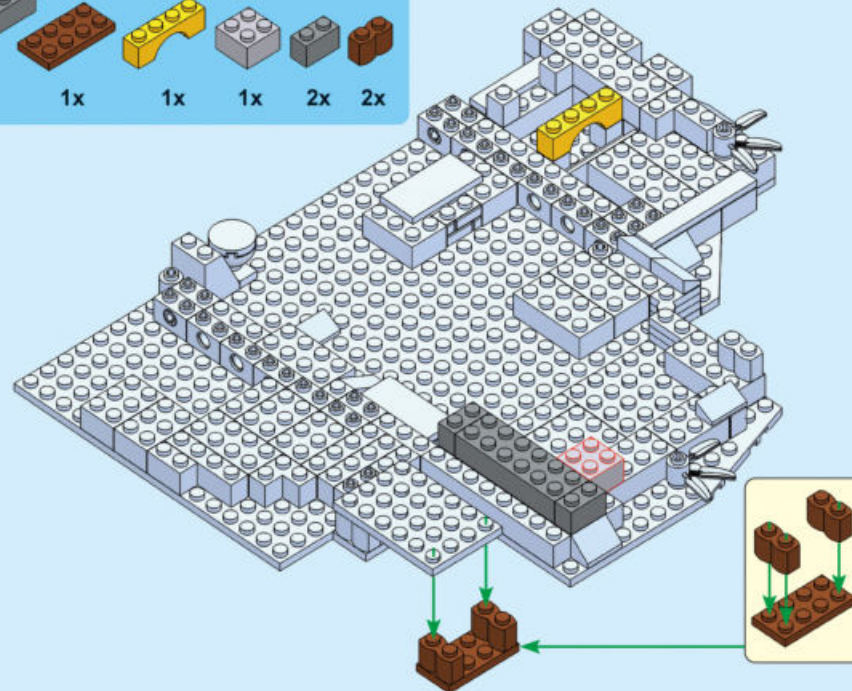



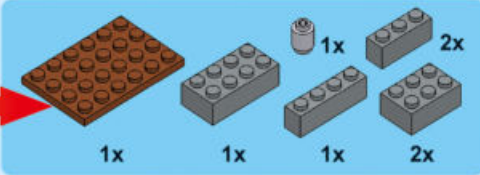

24.

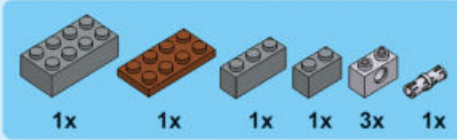
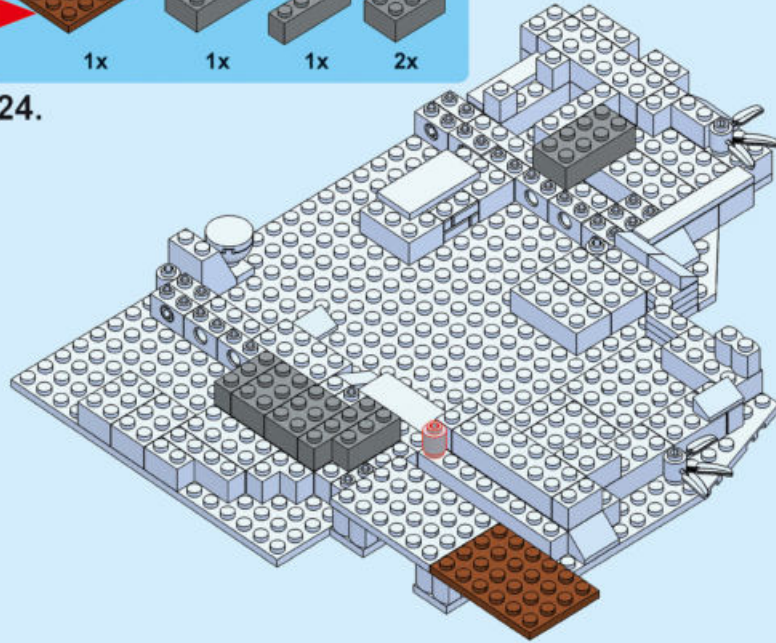

25.

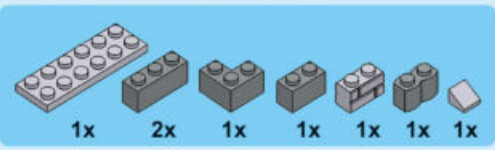
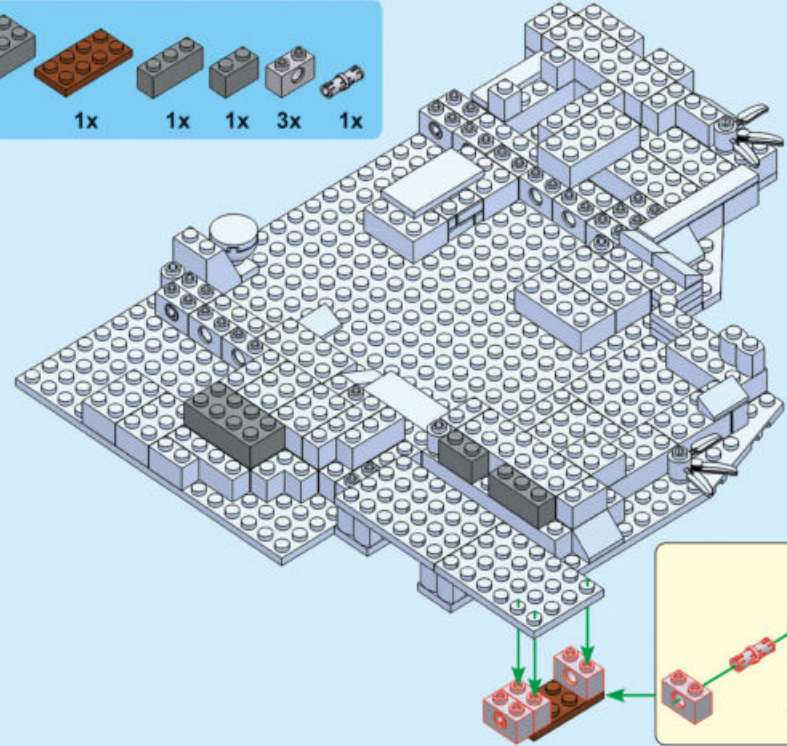

26.

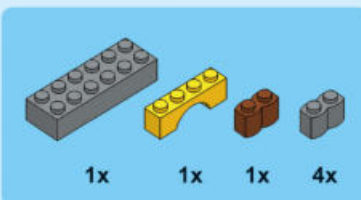
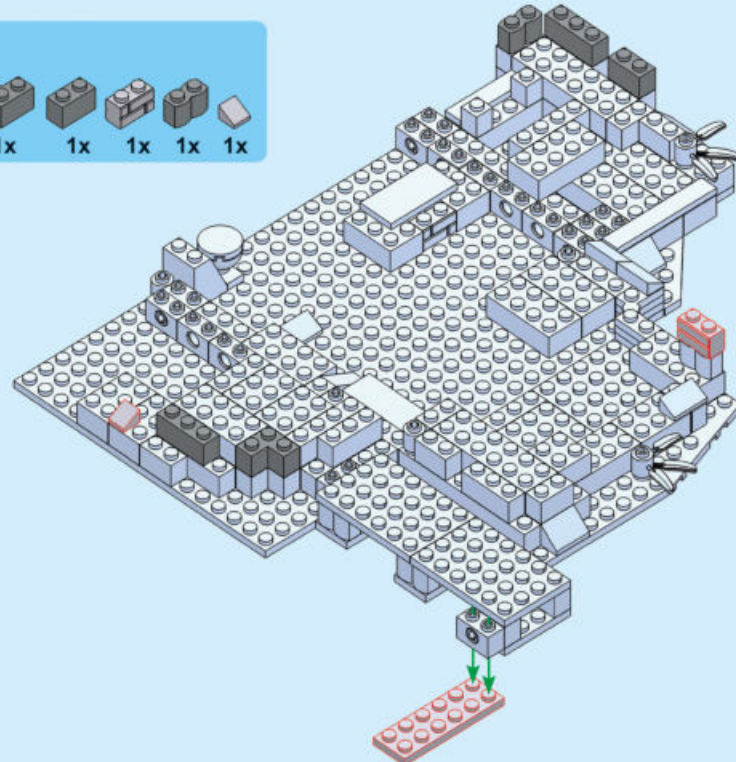

27.

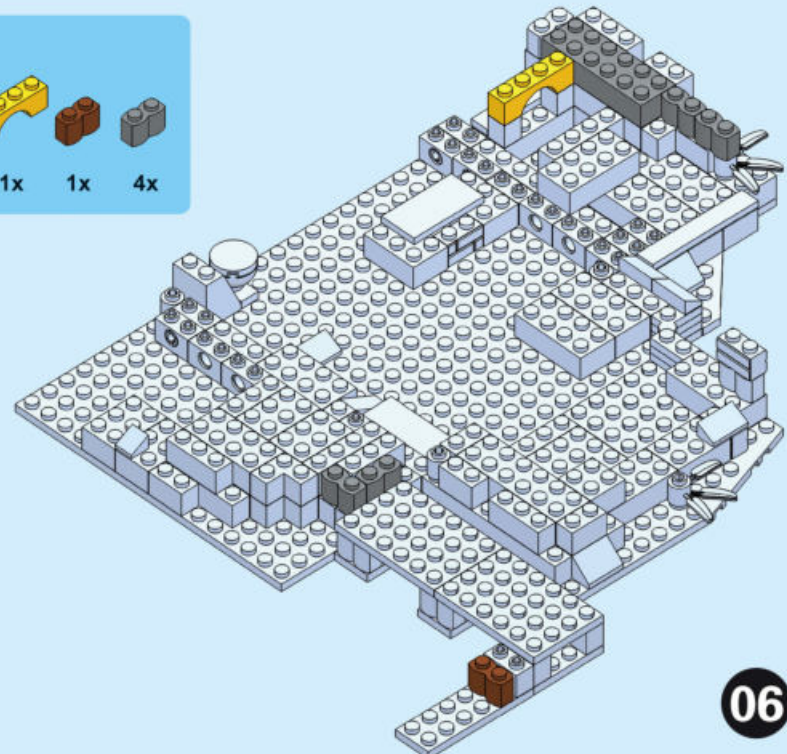



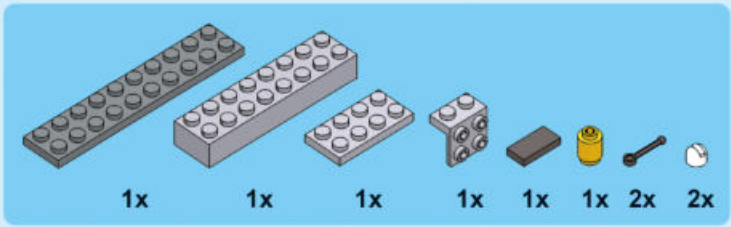

28.

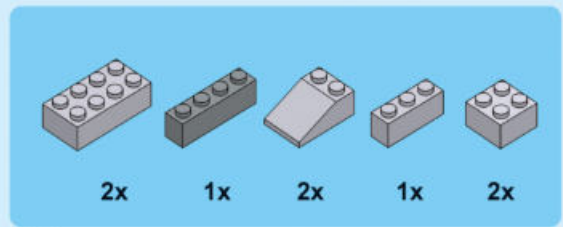
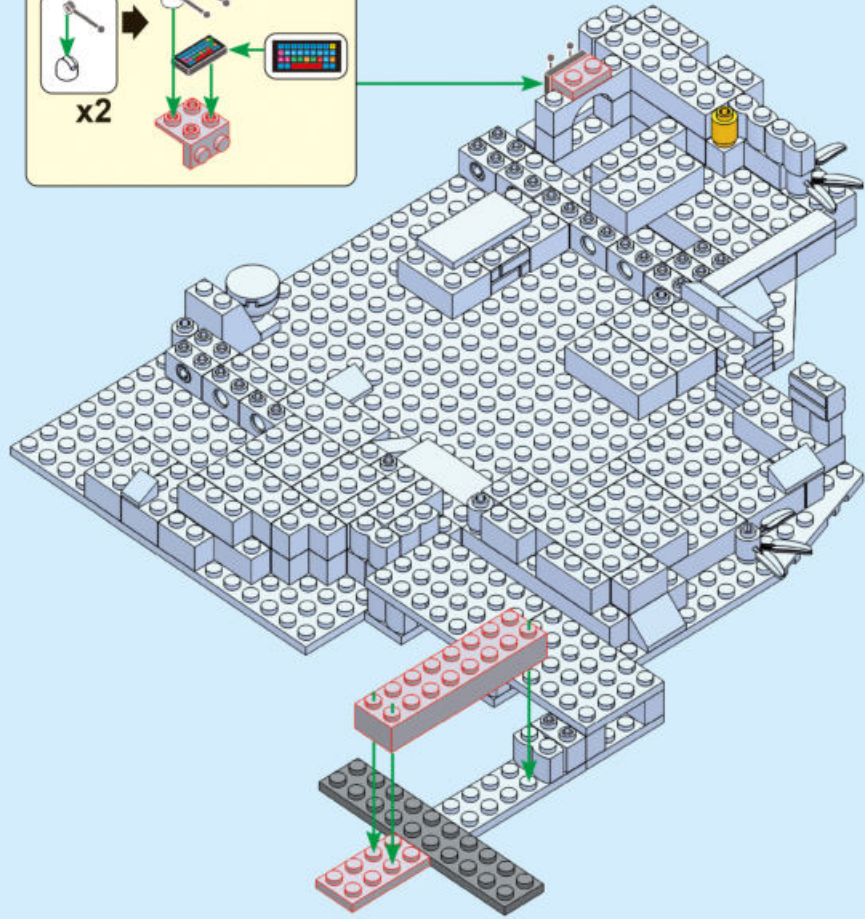
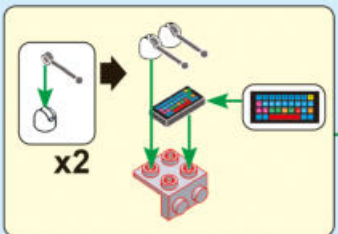

29.

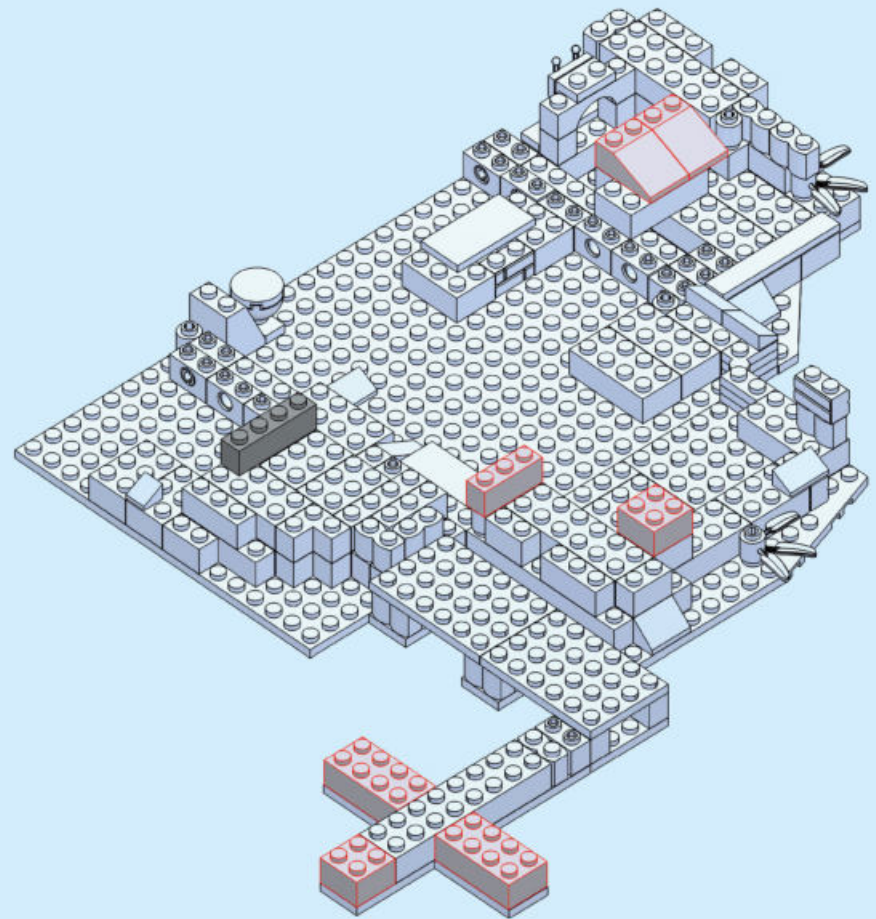



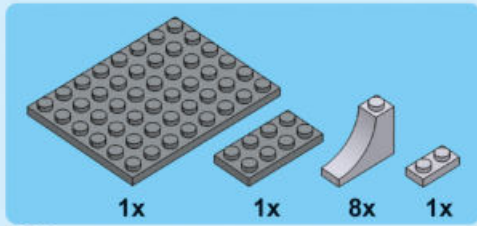

30.

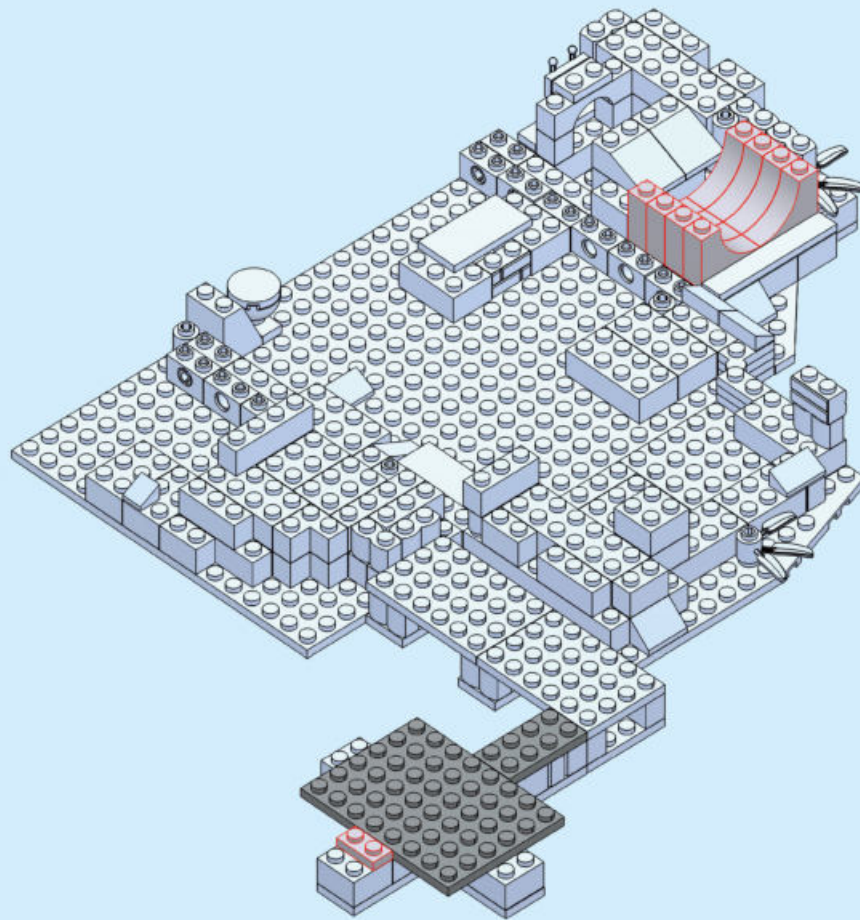

31.

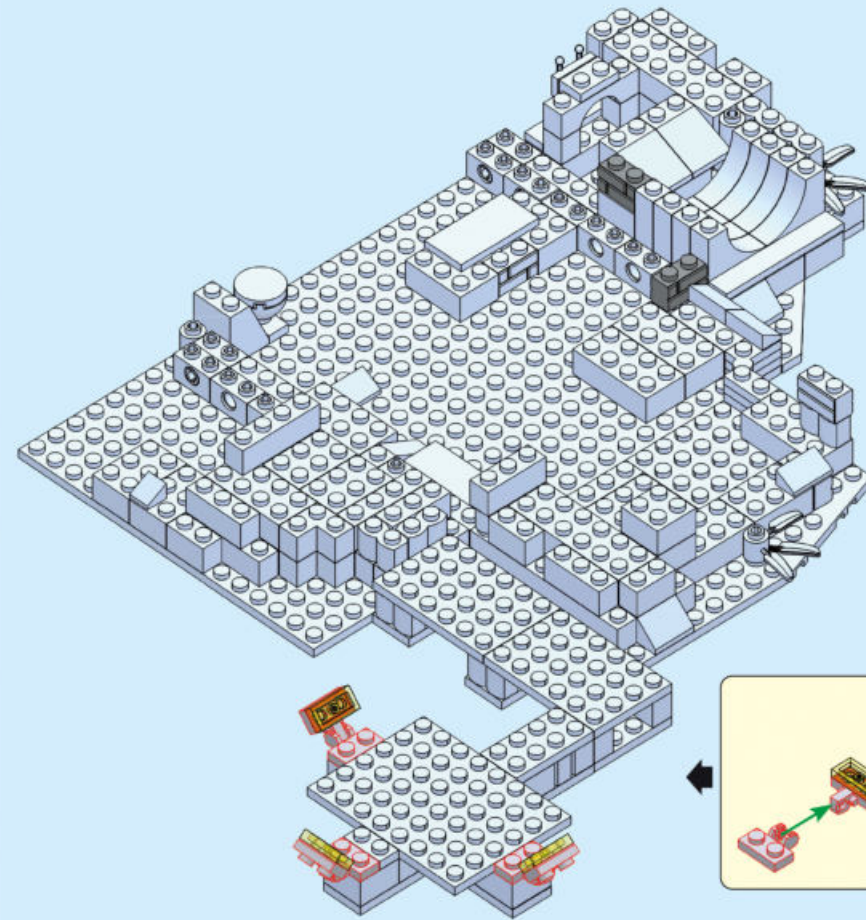



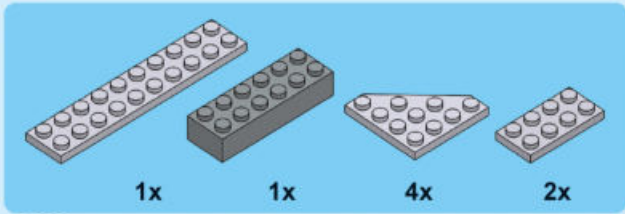

32.

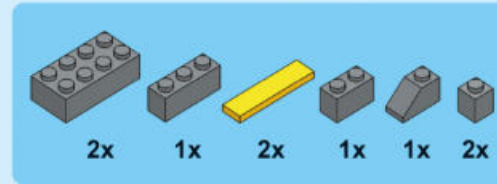
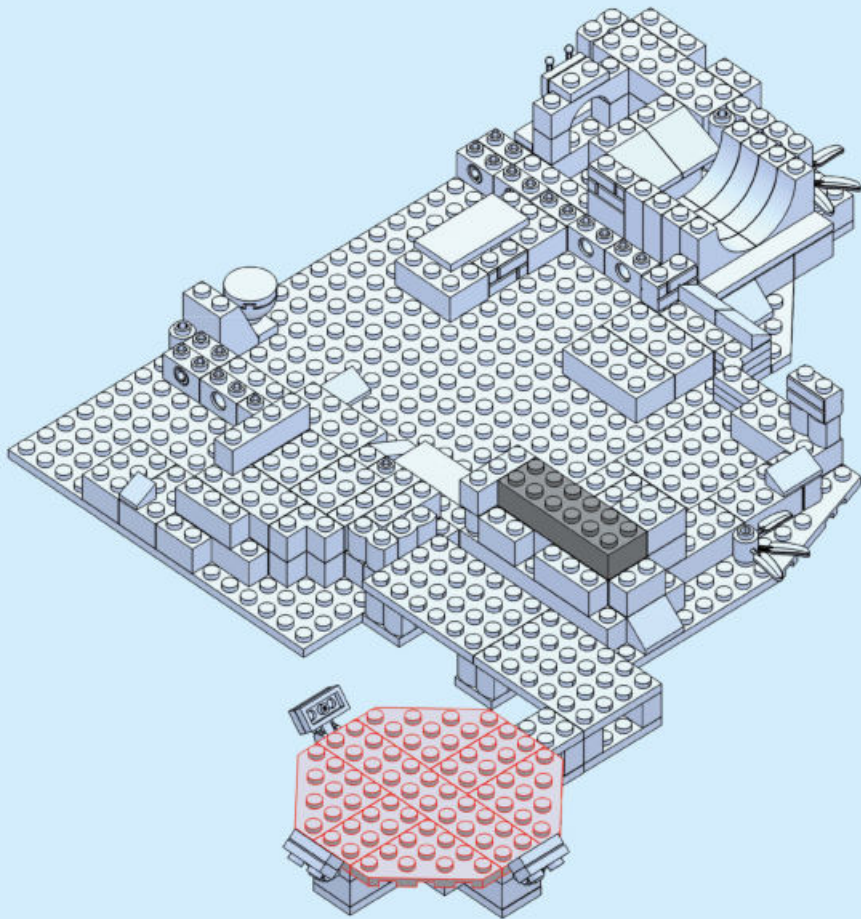

33.

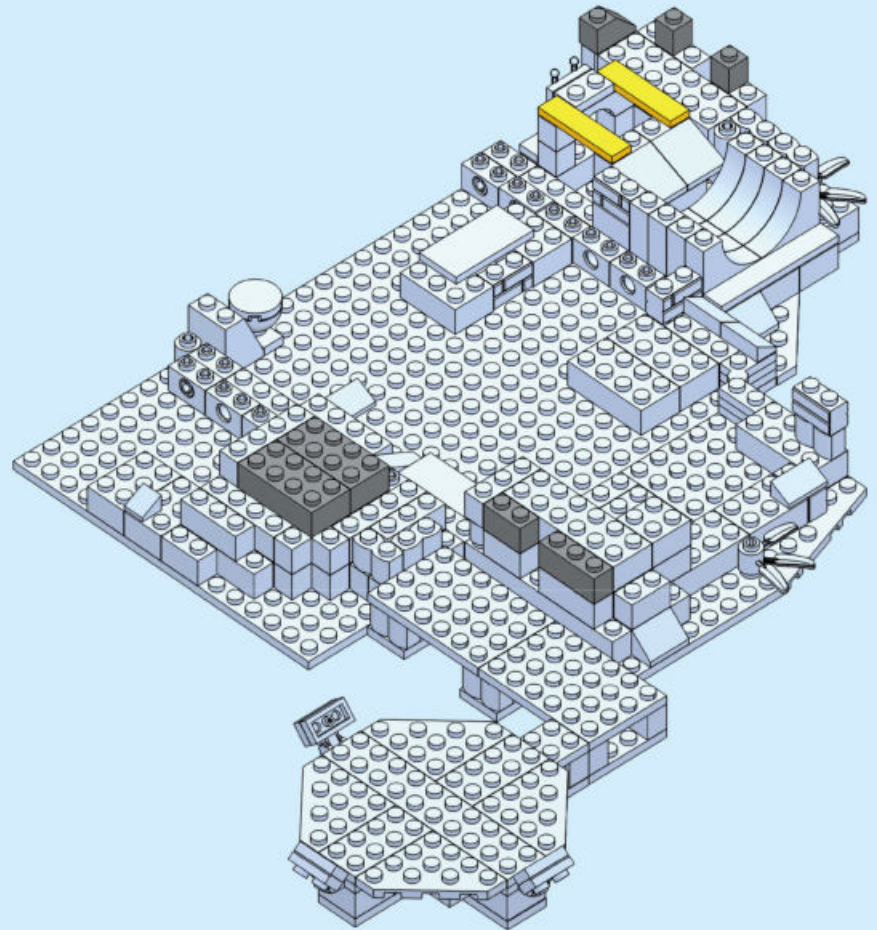



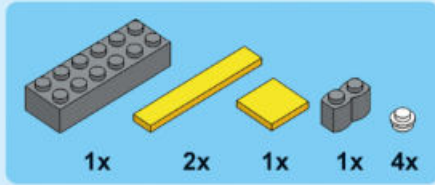

34.

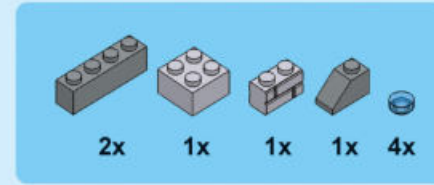
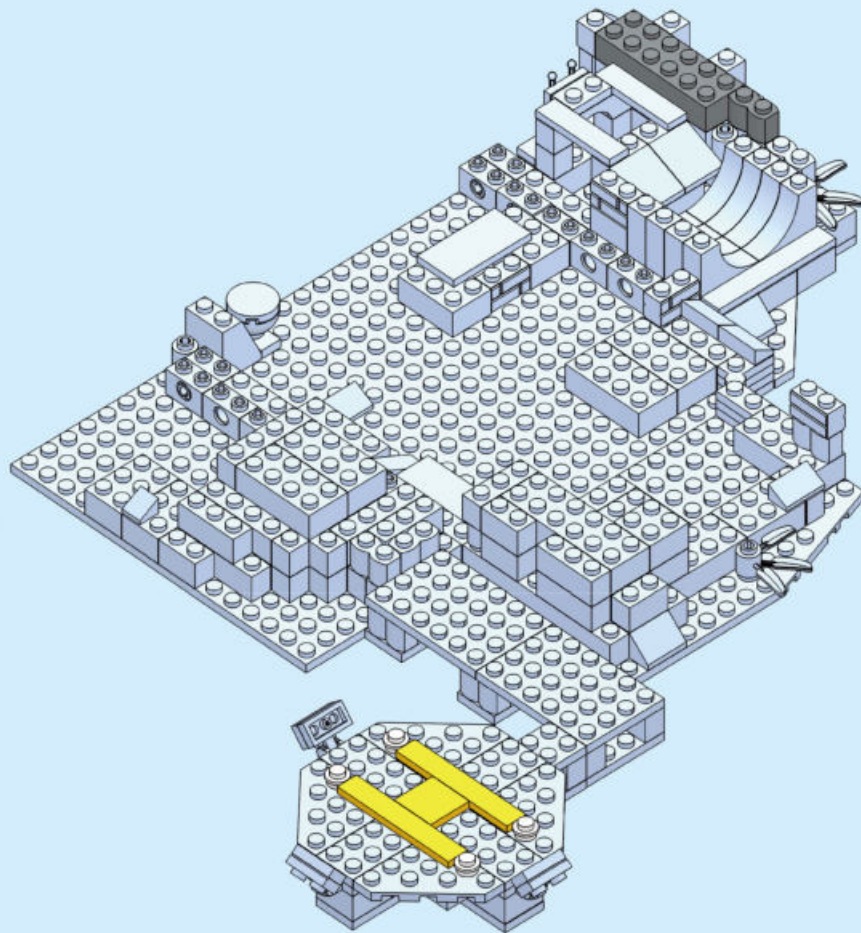

35.





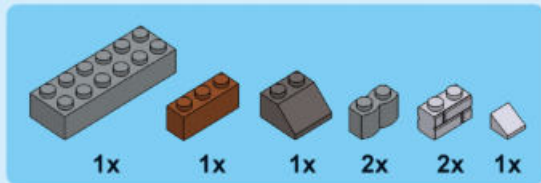

36.

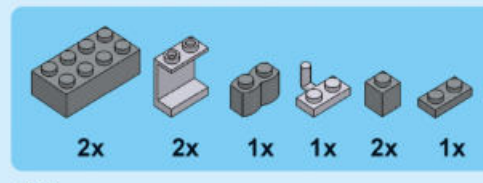

37.

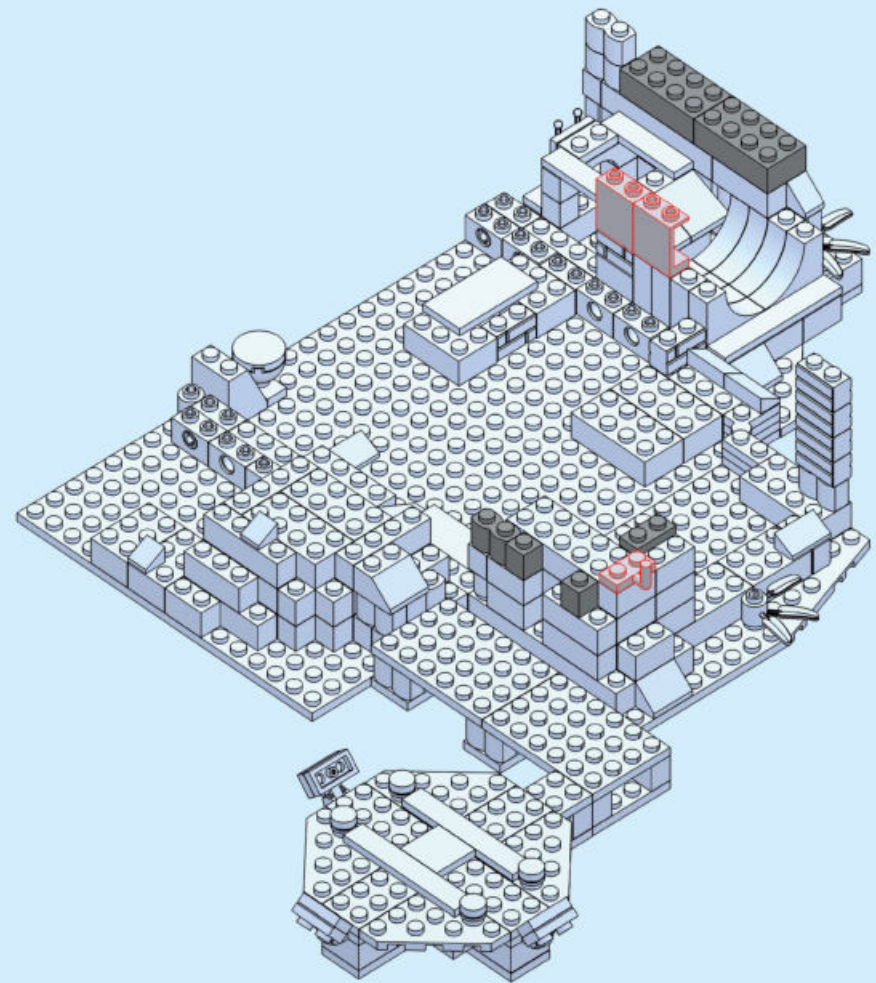



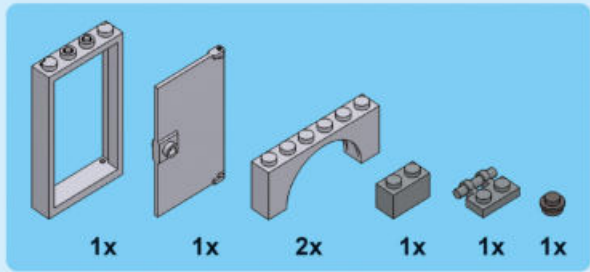

38.

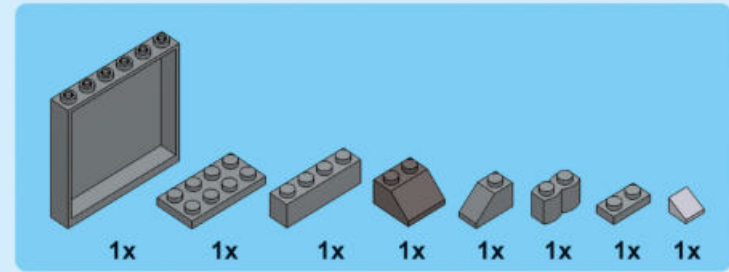
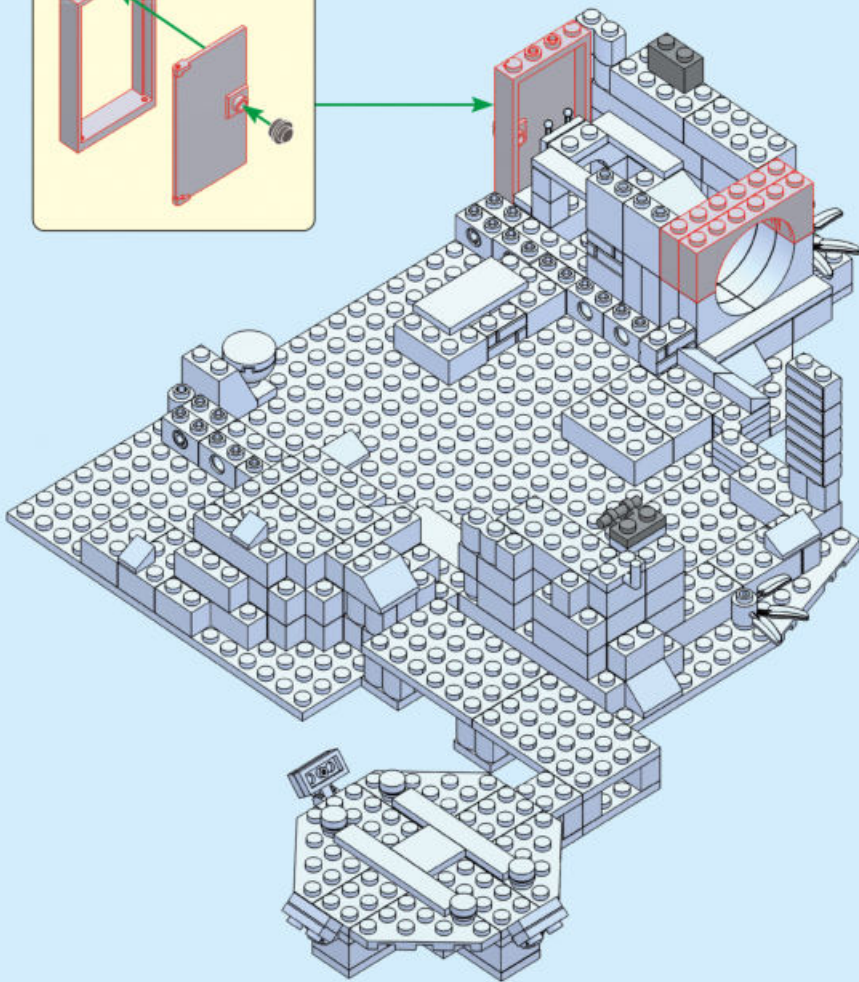
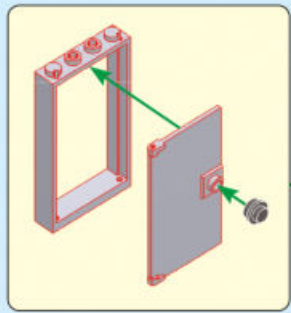

39.

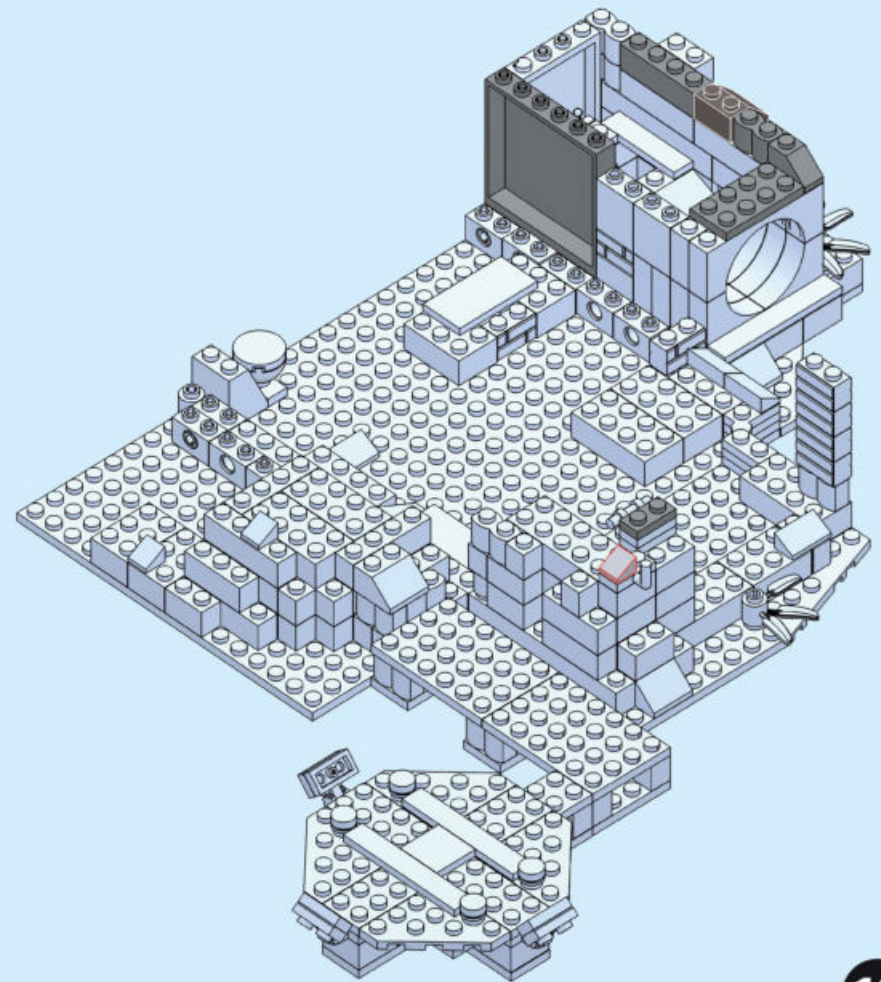



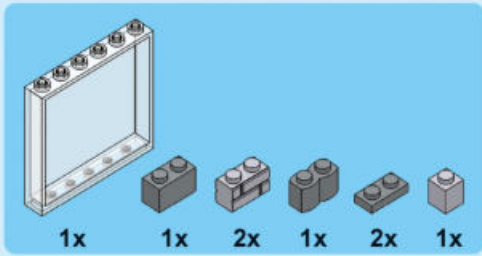

40.

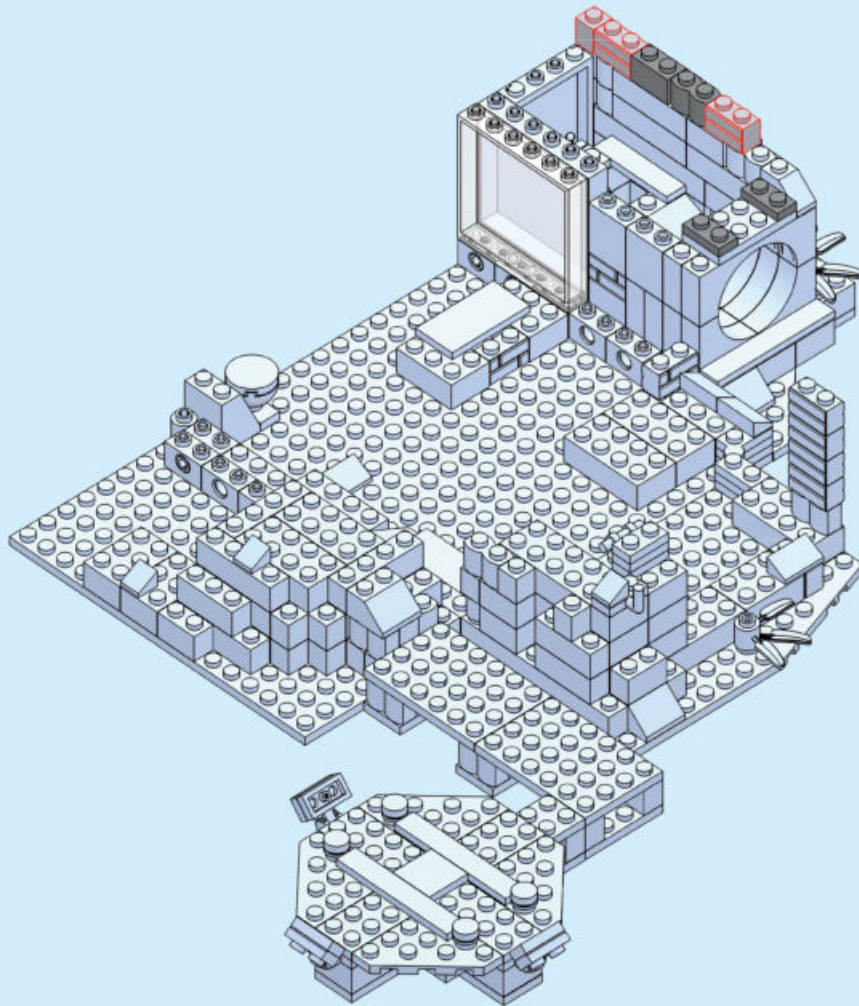

41.

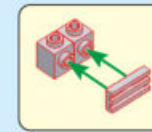

x2

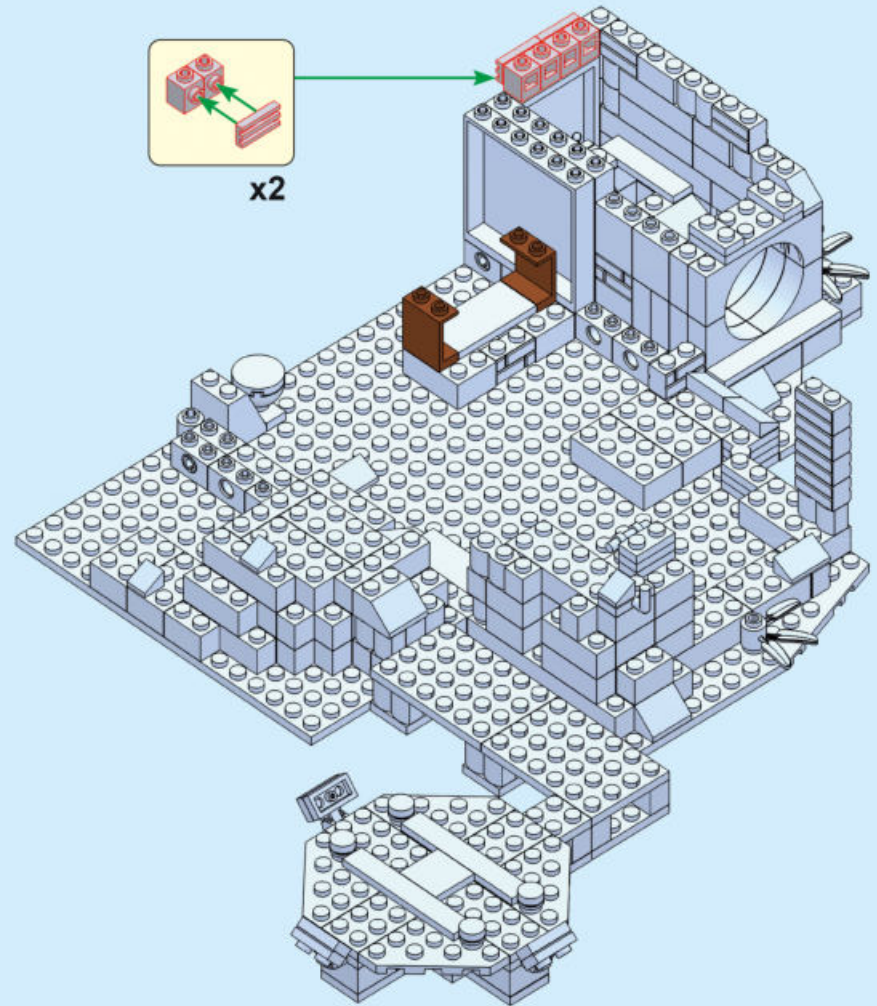



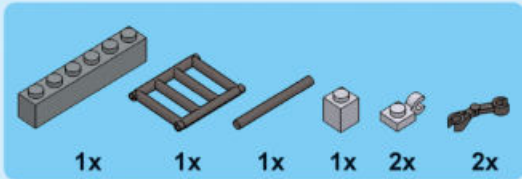

42.

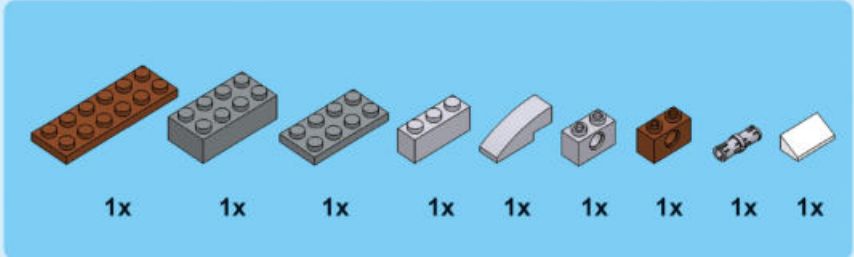
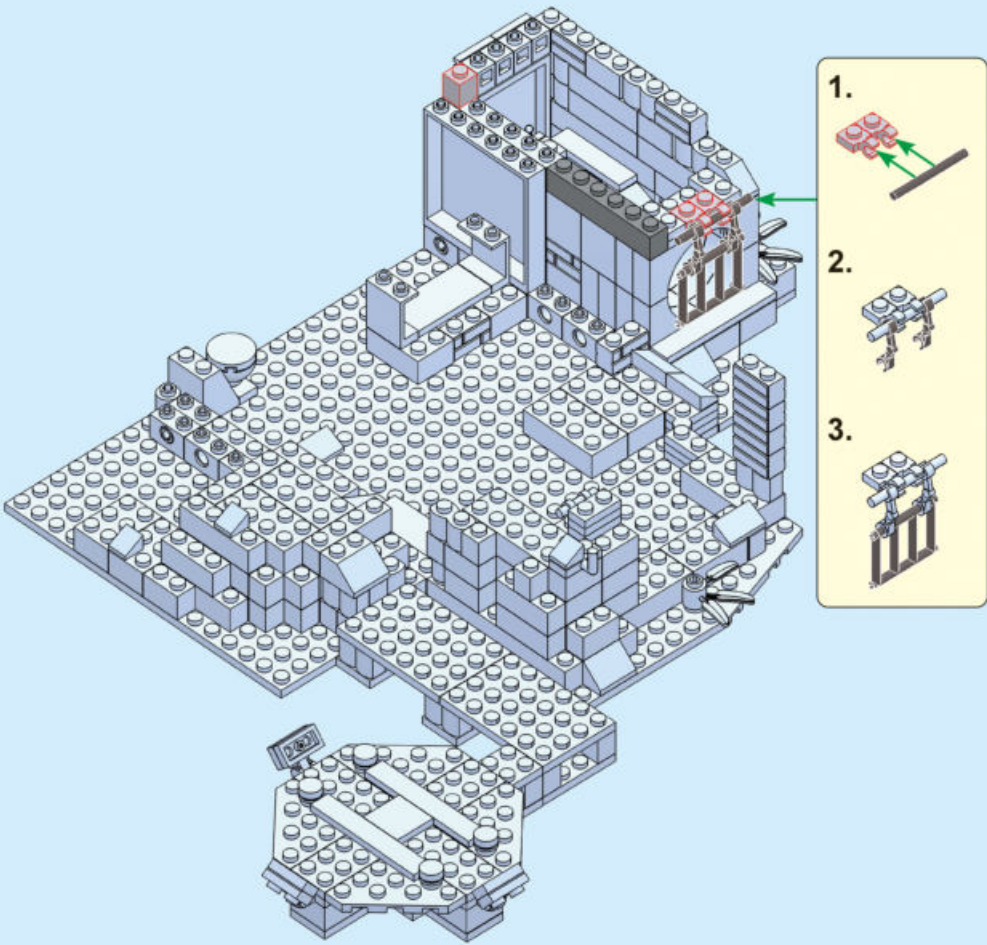

43.

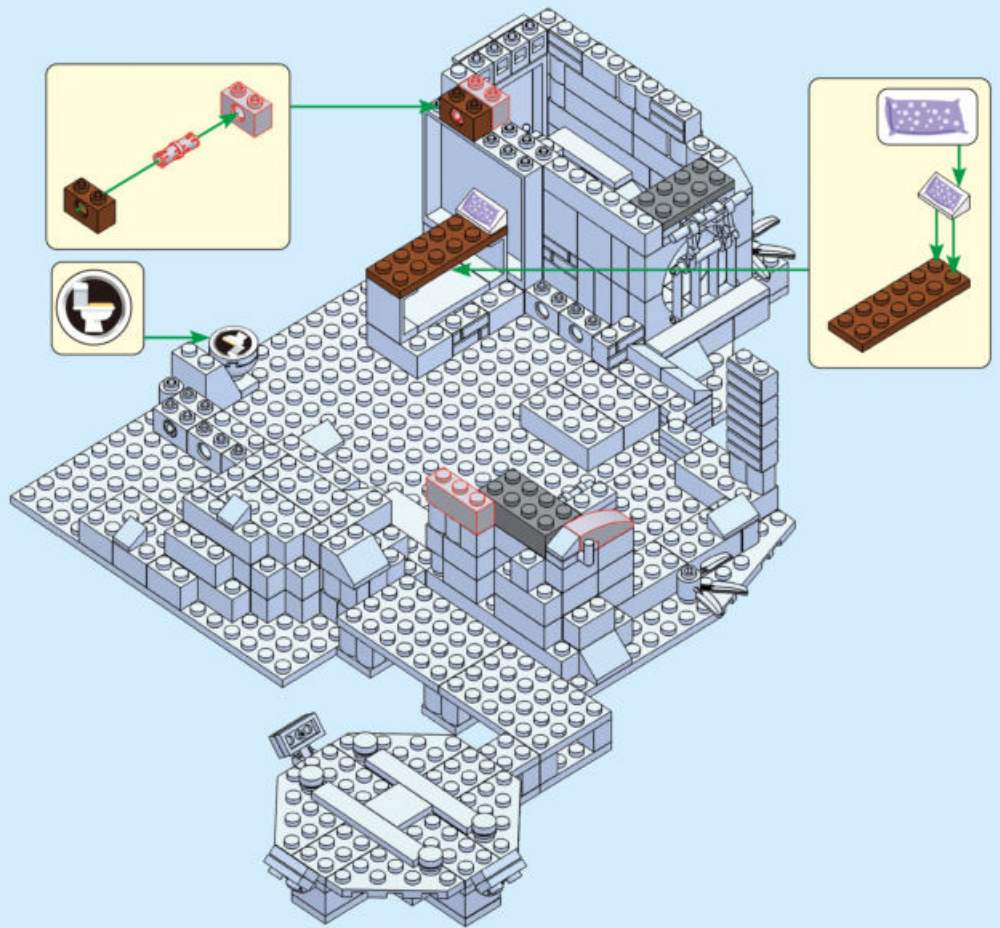



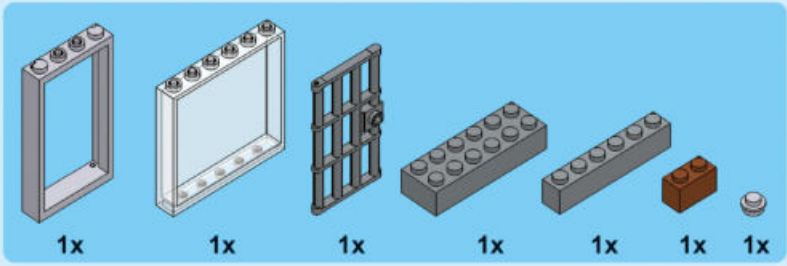

44.

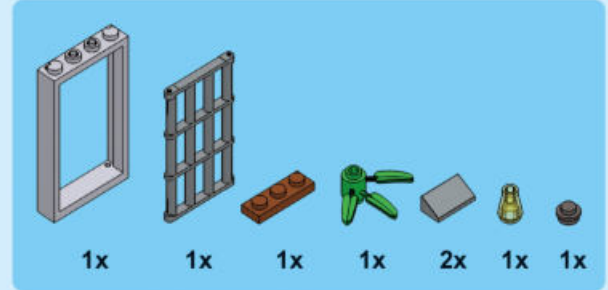
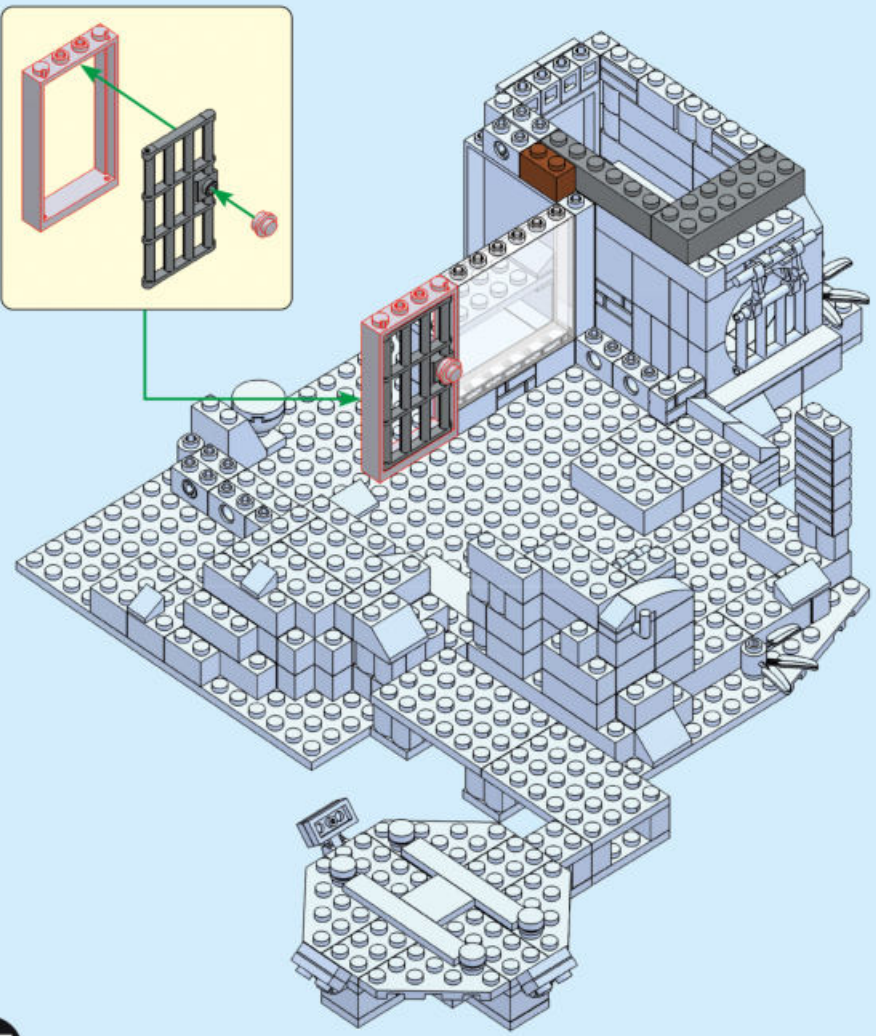

45.

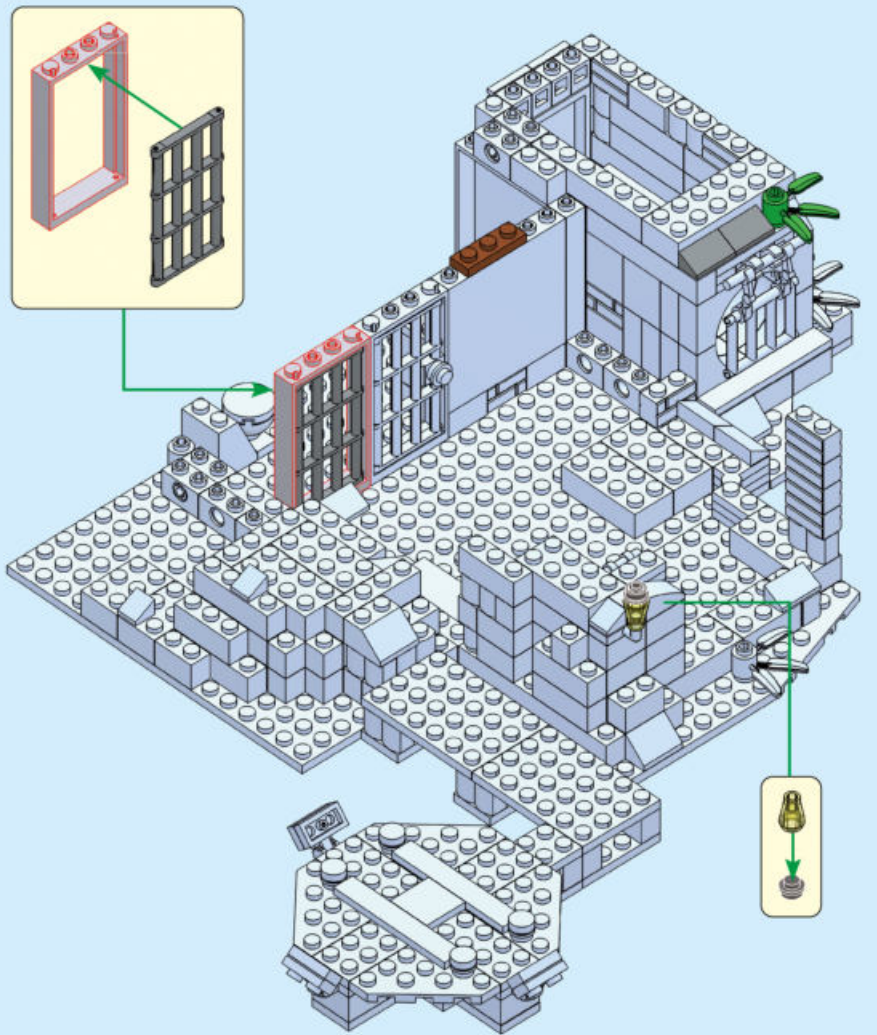



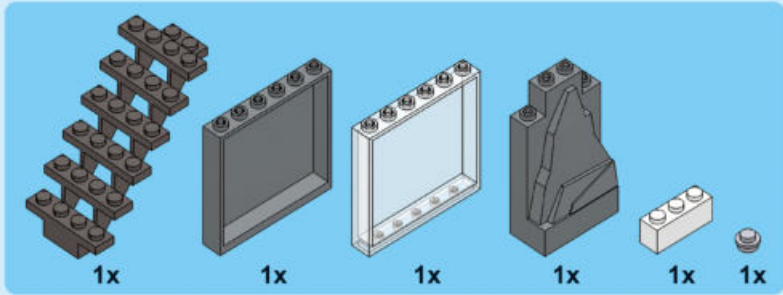

46.

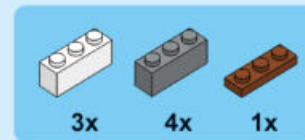
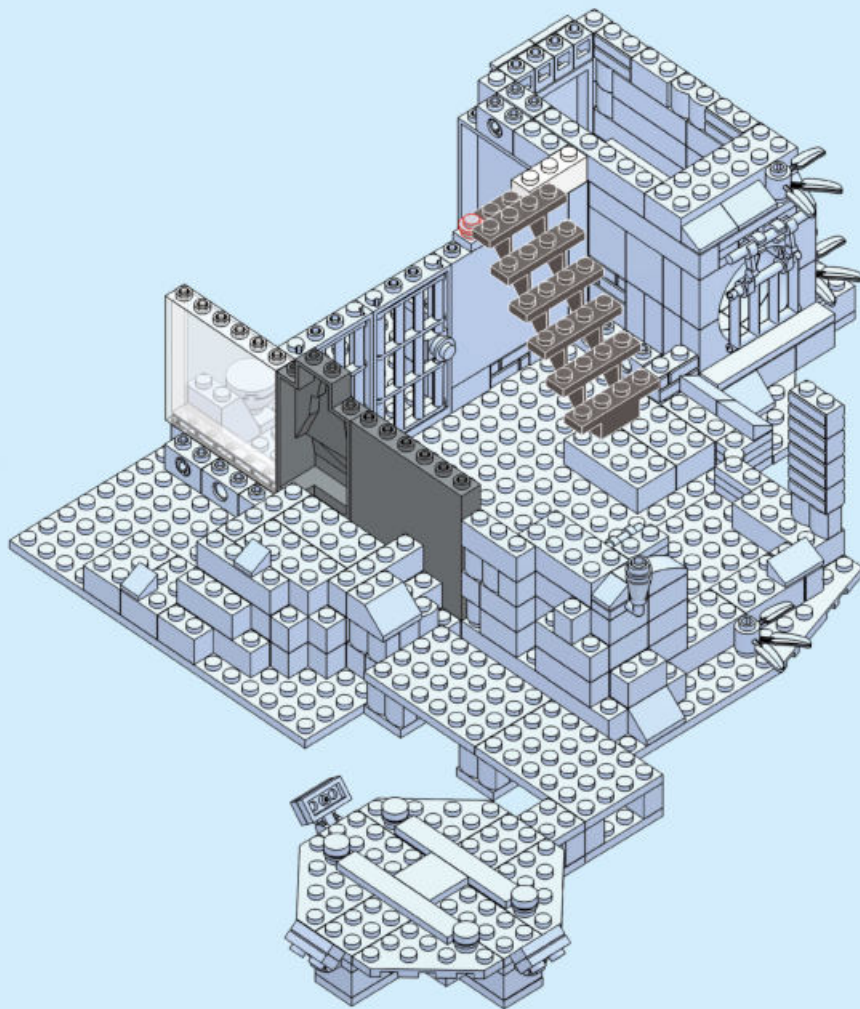

47.

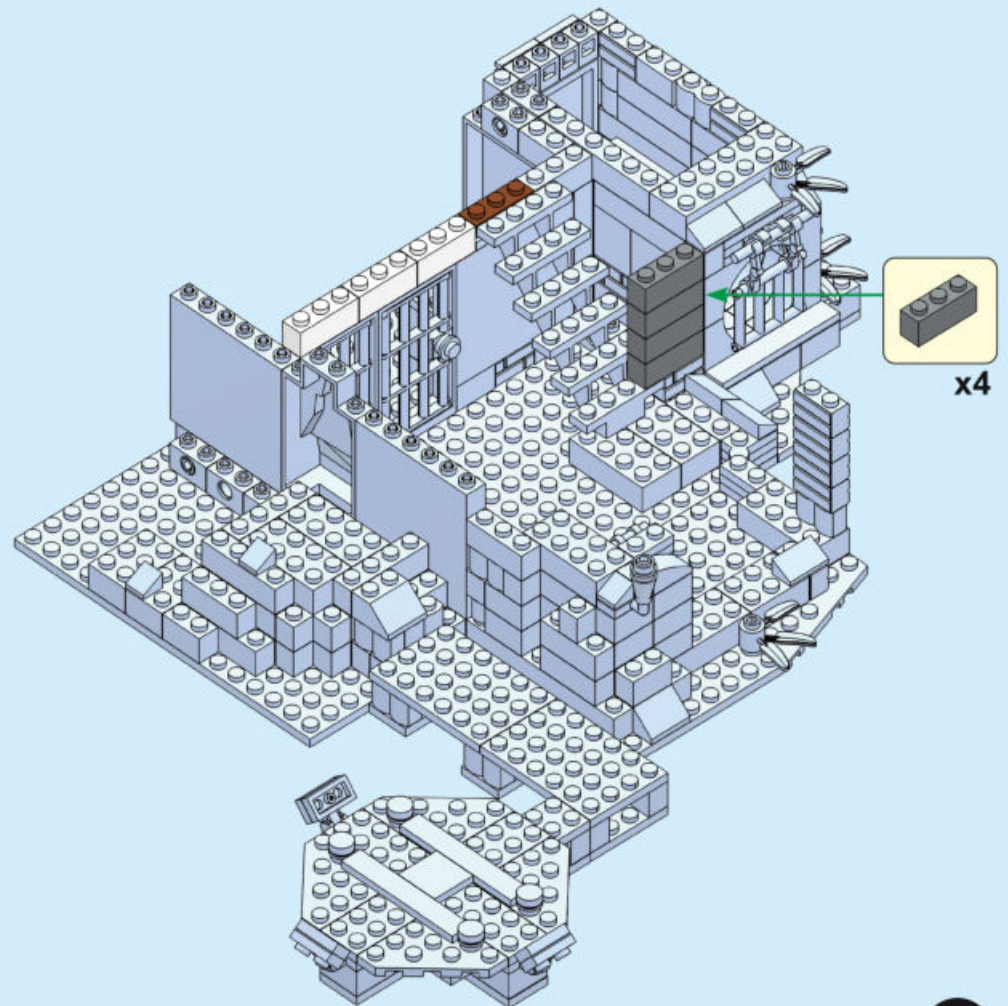



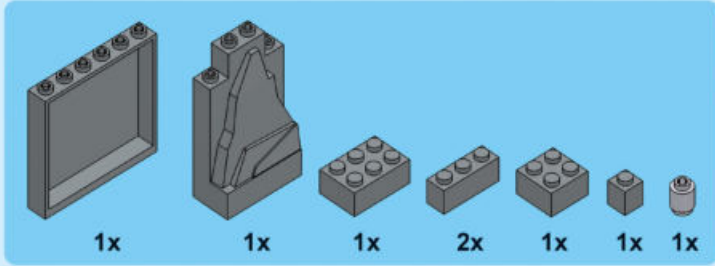

48.

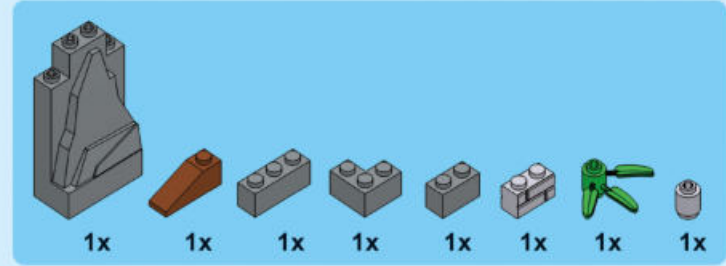

49.

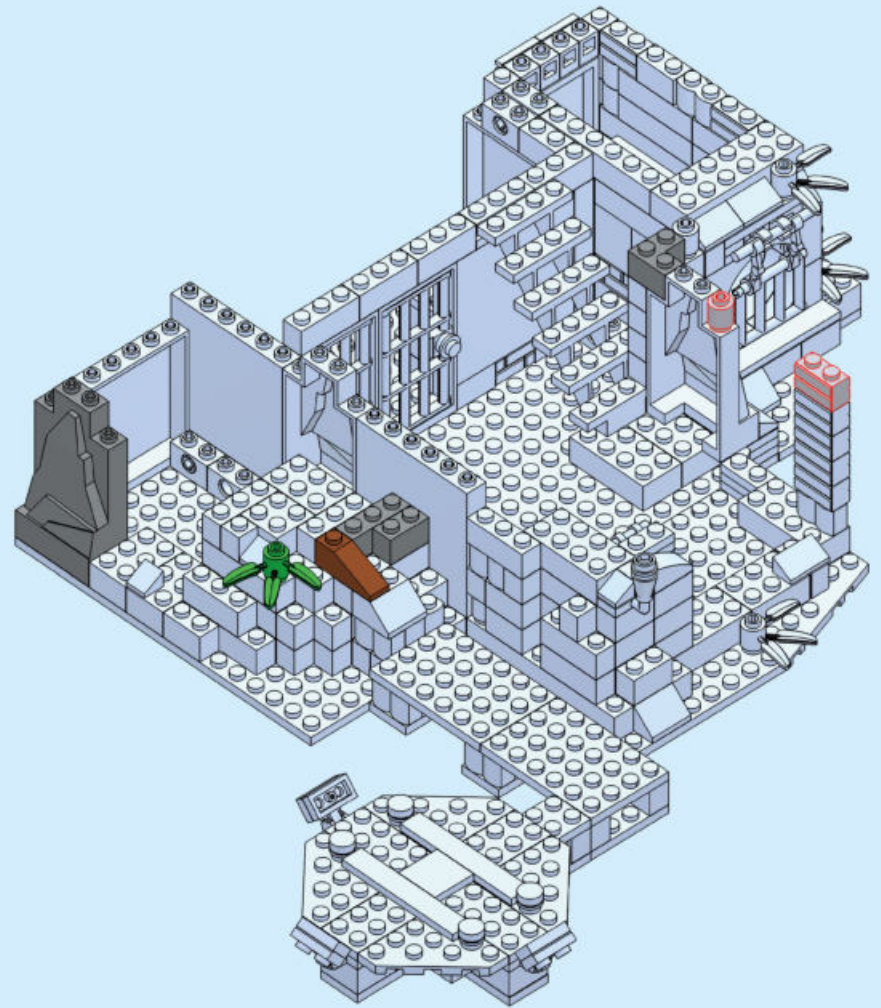



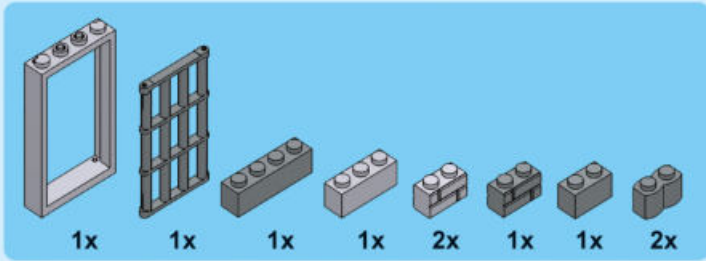

50.

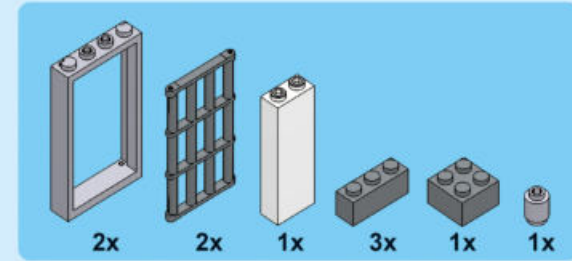
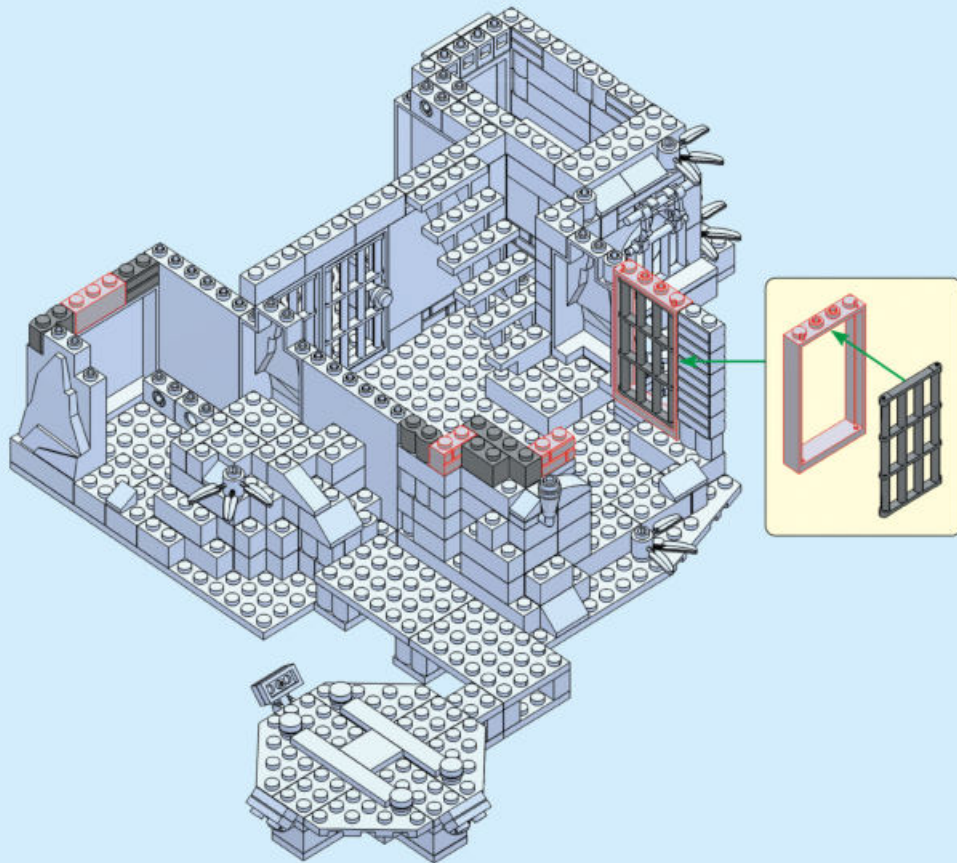

51.

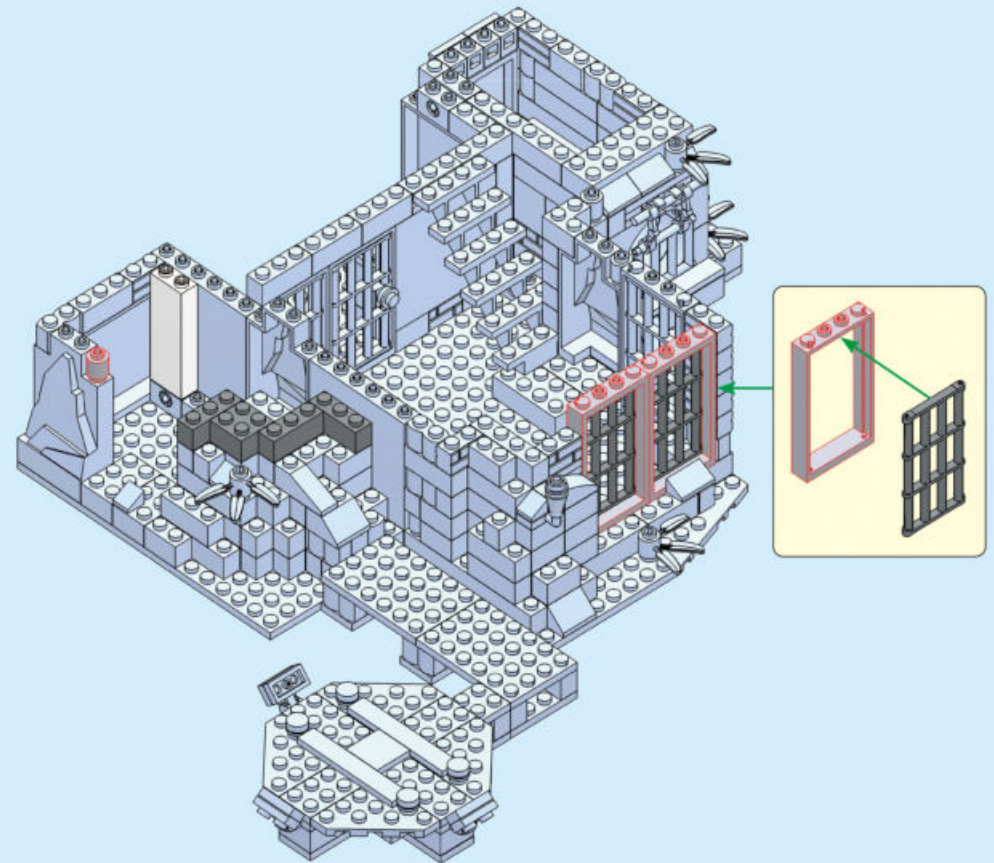



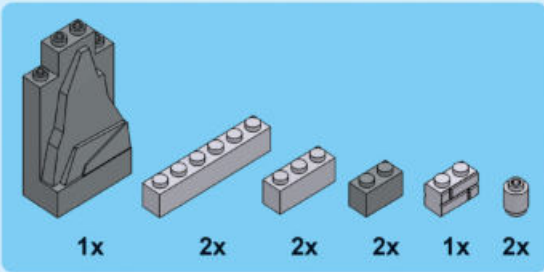

52.

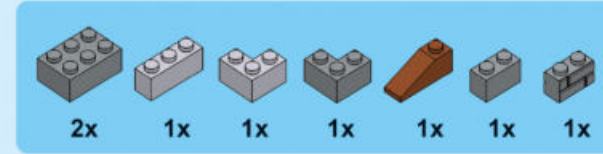
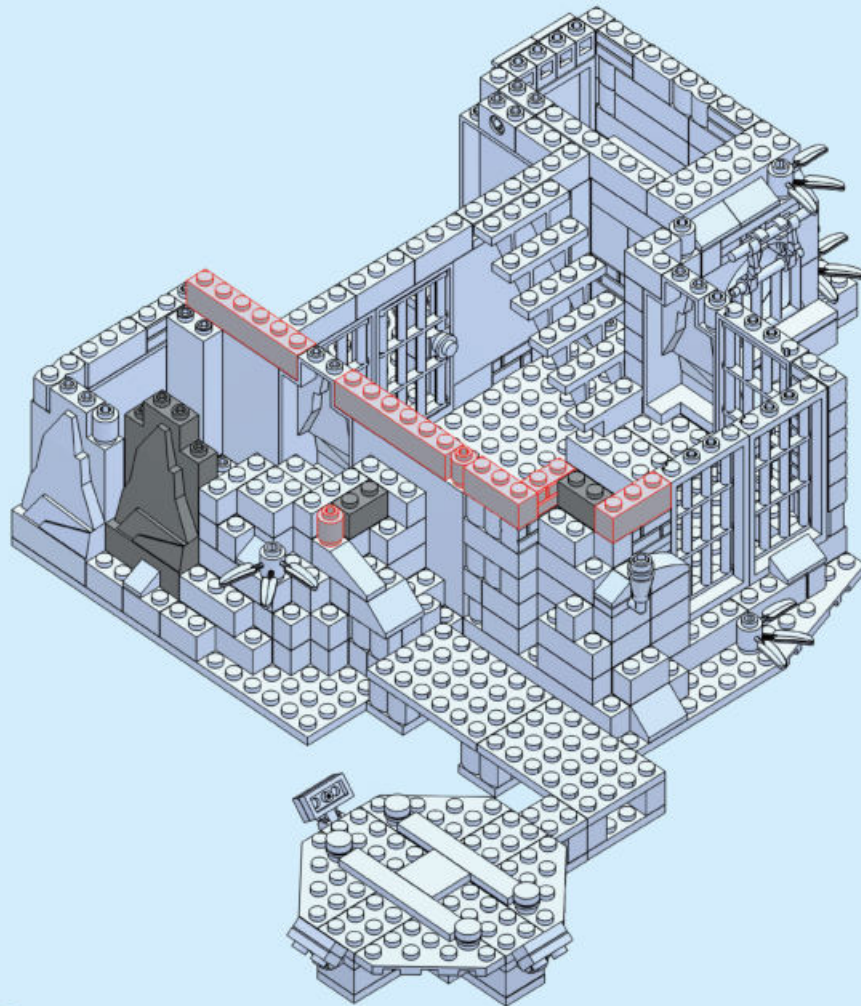

53.

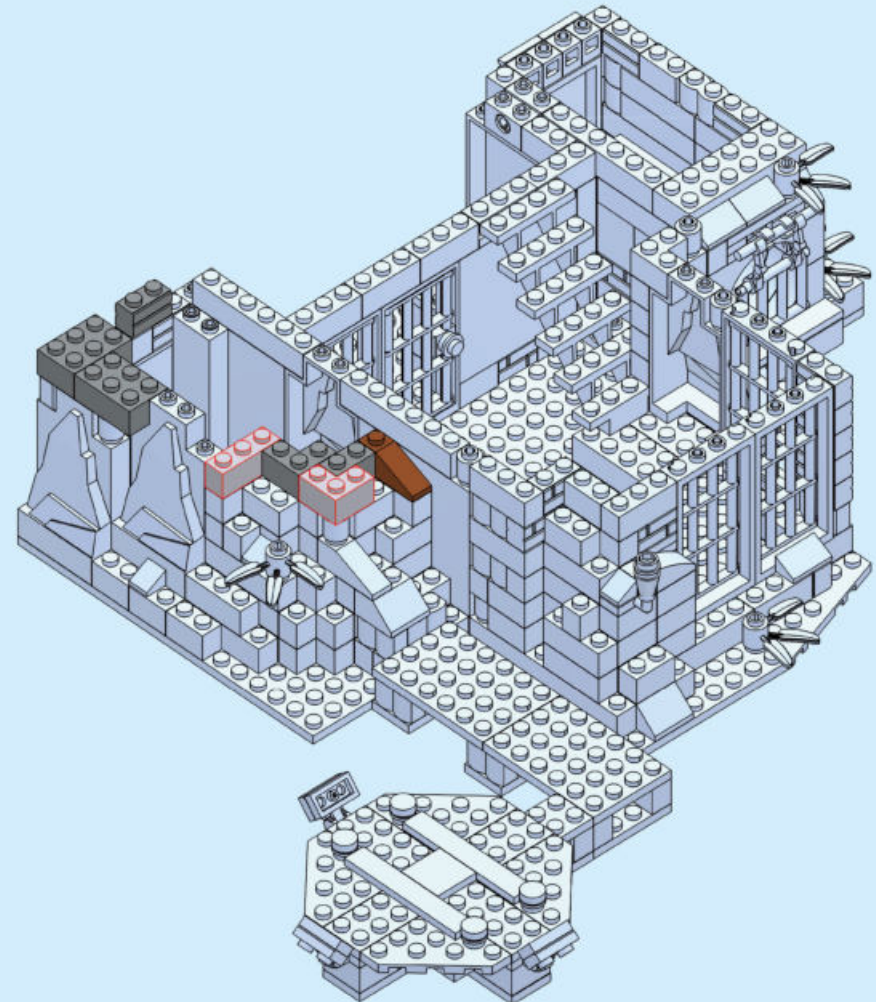



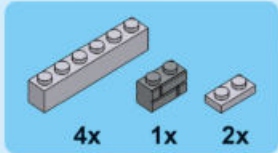

54.

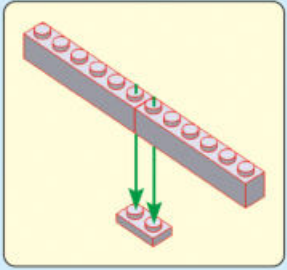

x2

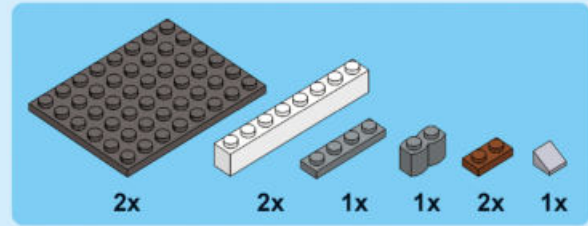
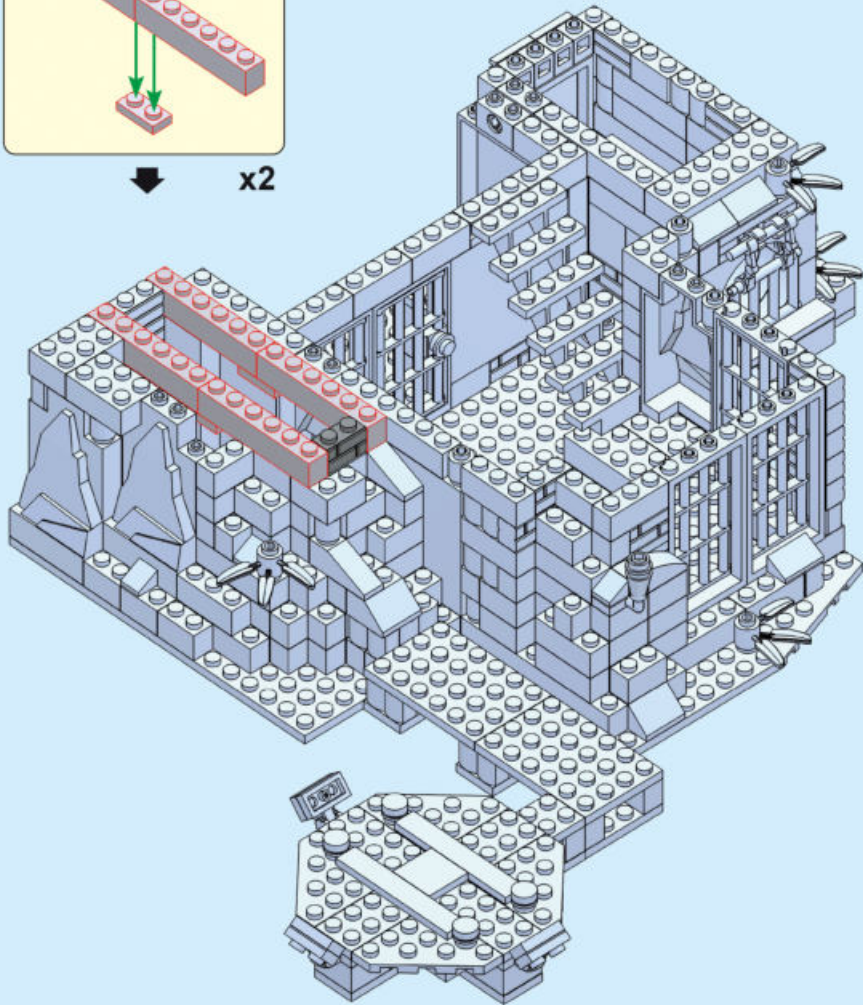

55.

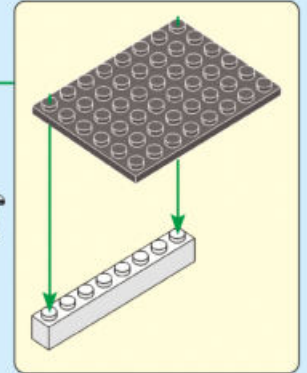

x2

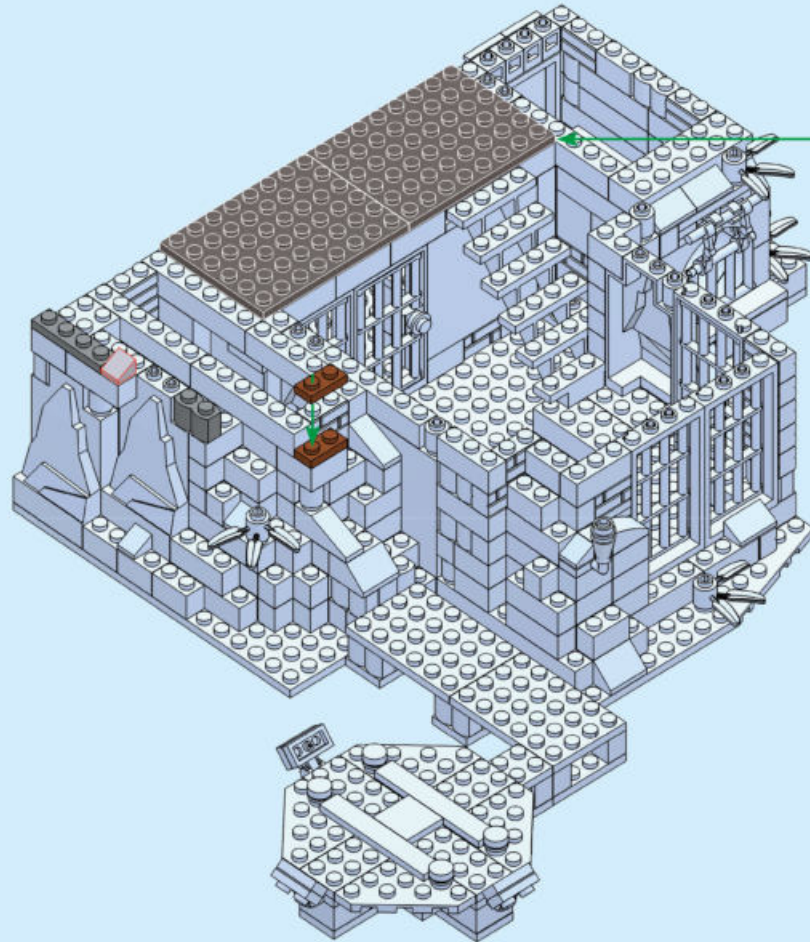





4

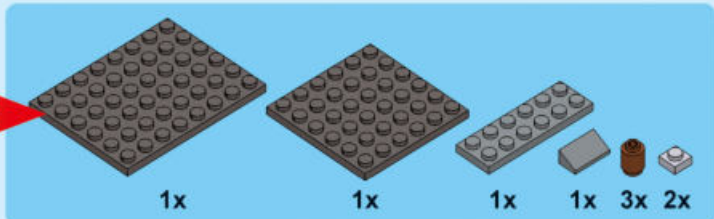

56.

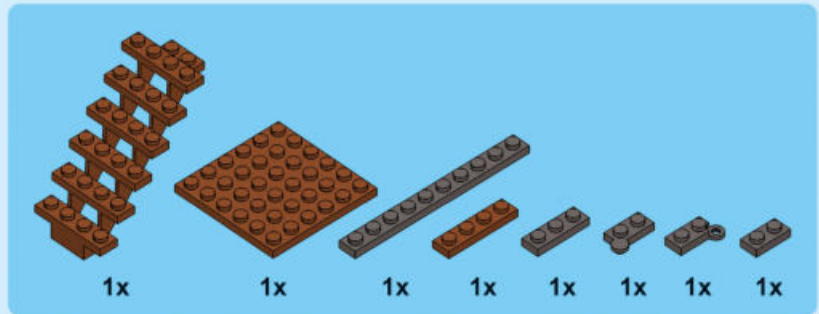

57.

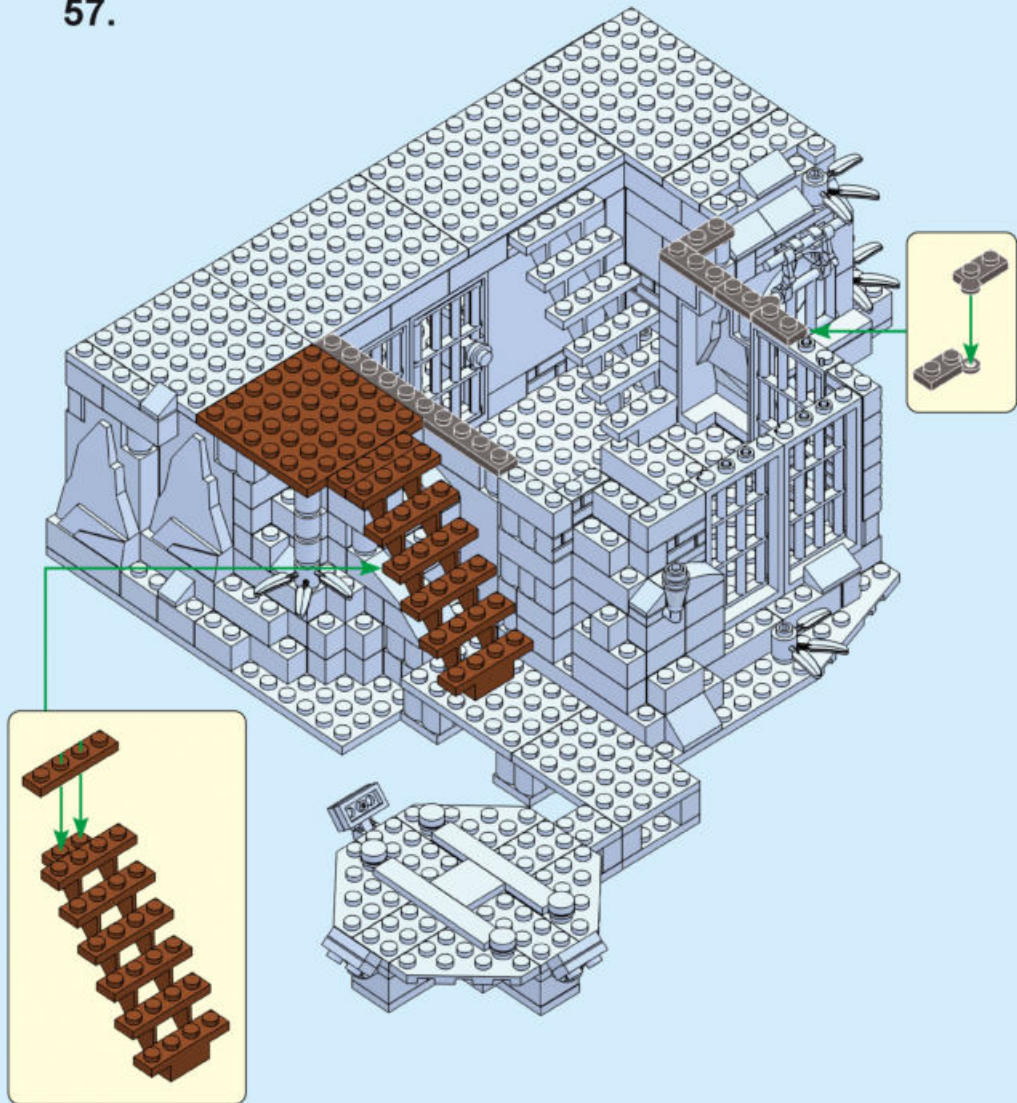



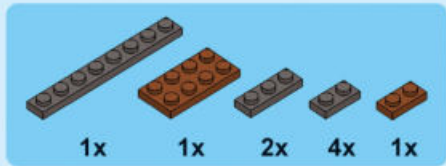

58.

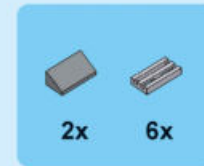
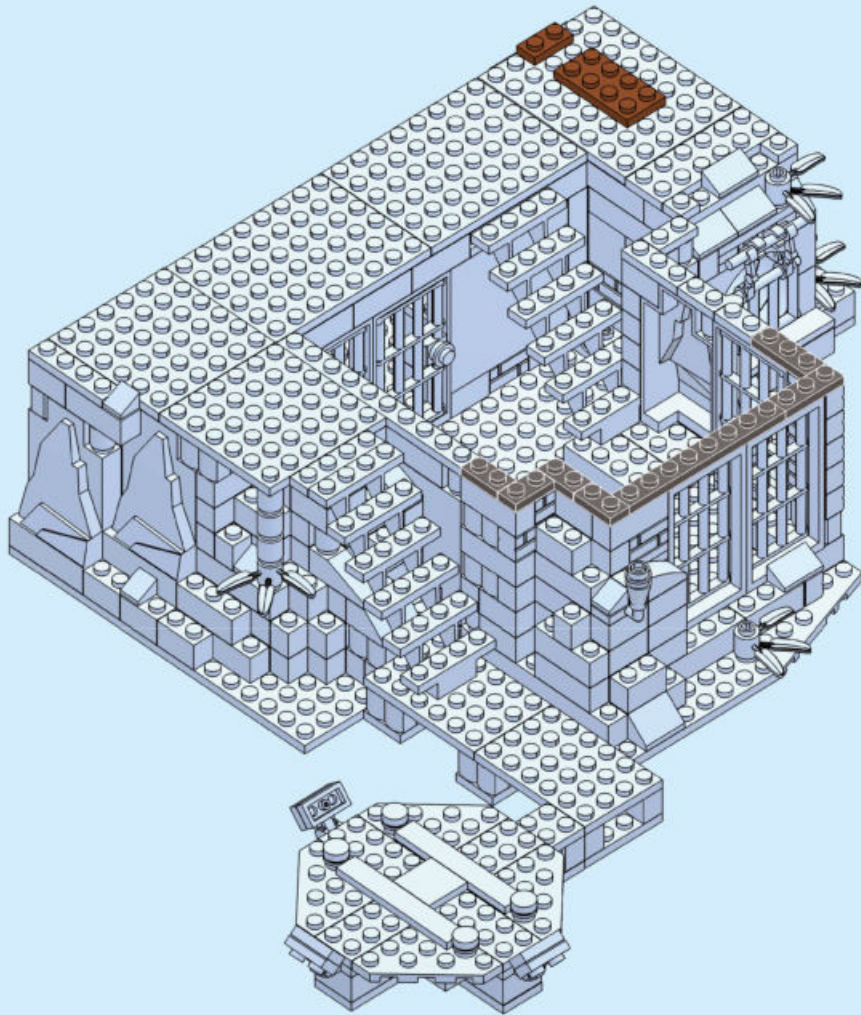

59.

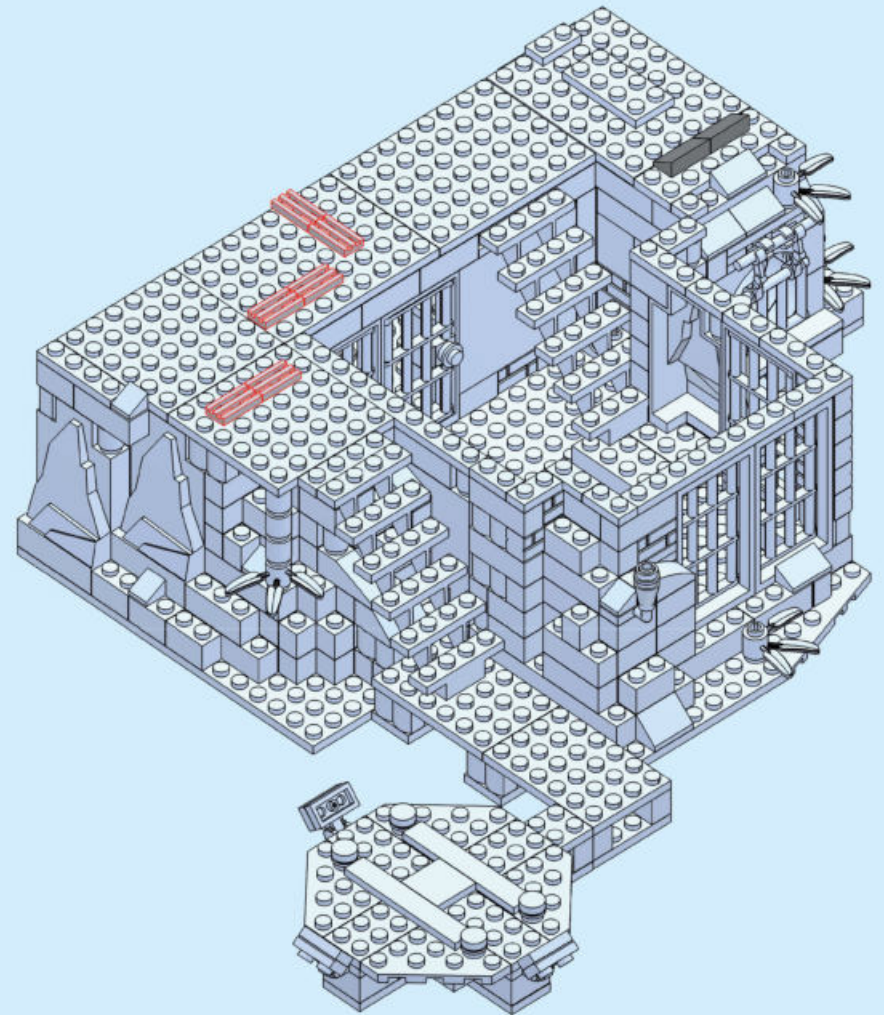



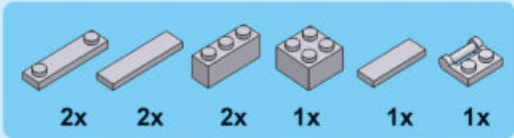

60.

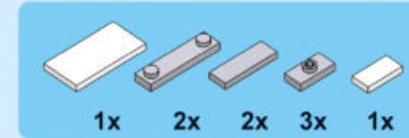
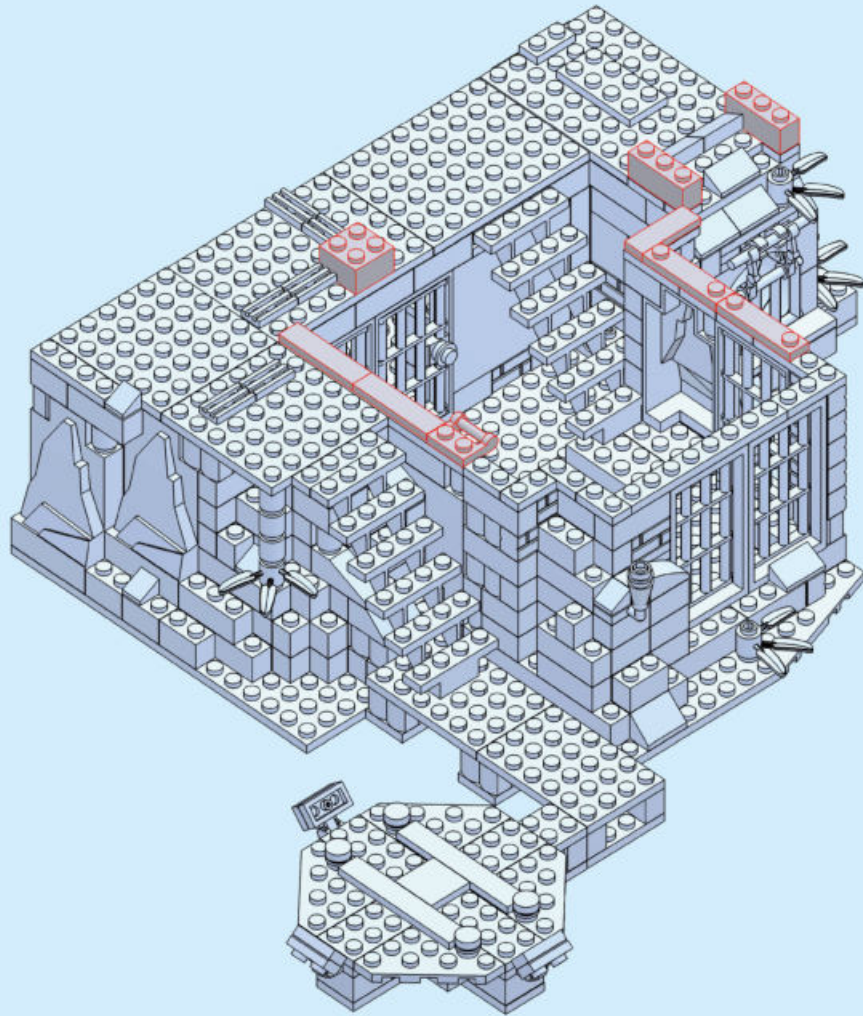

61.

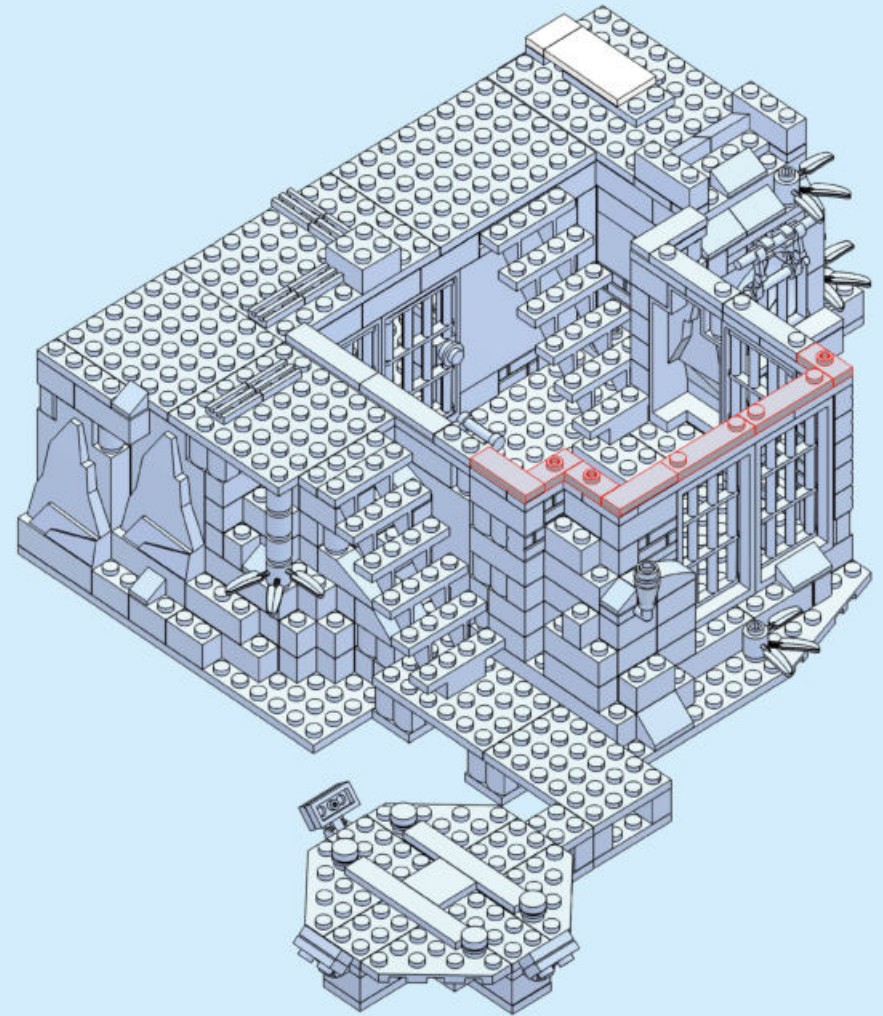



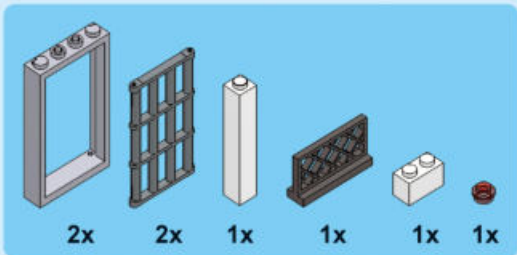

62.

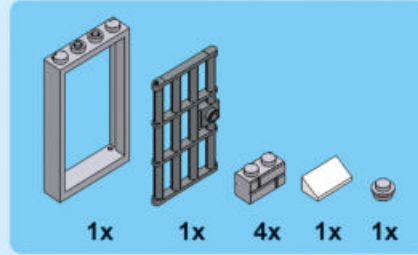
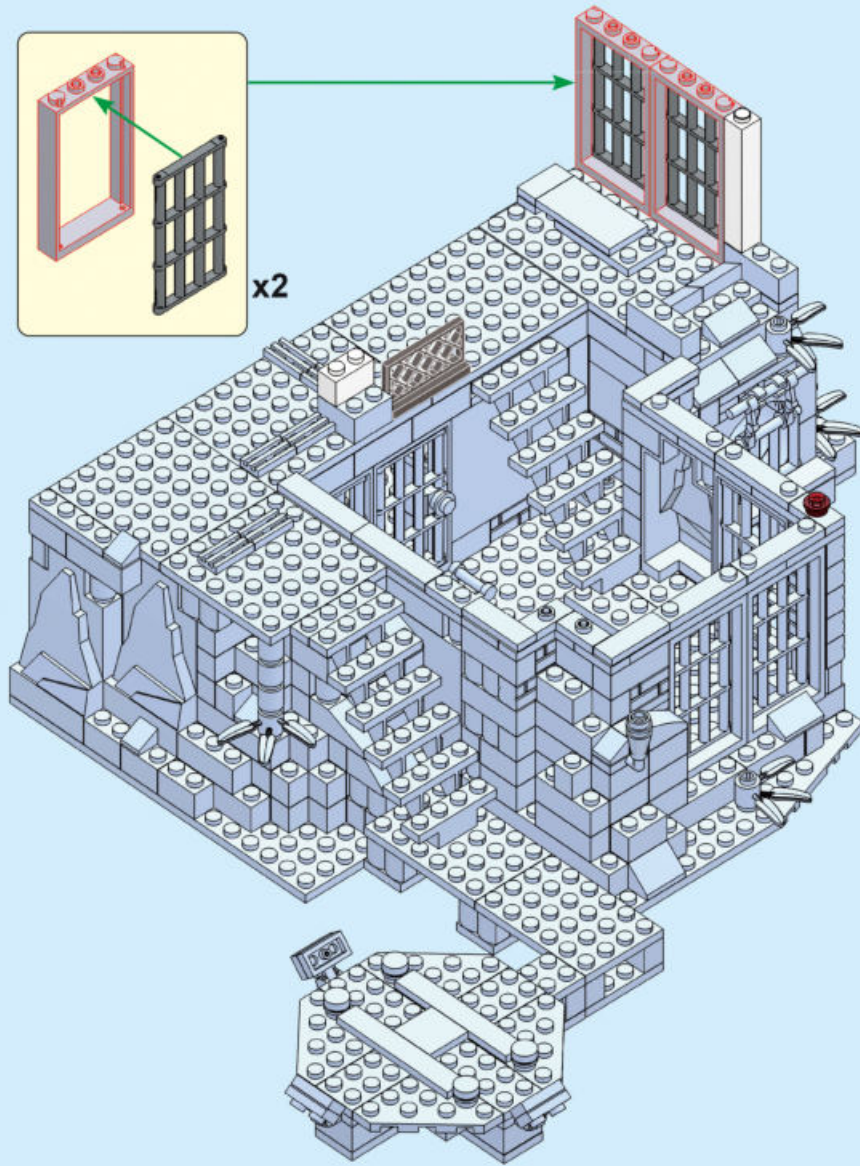
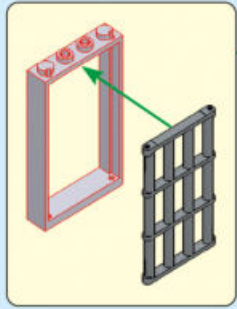

63.

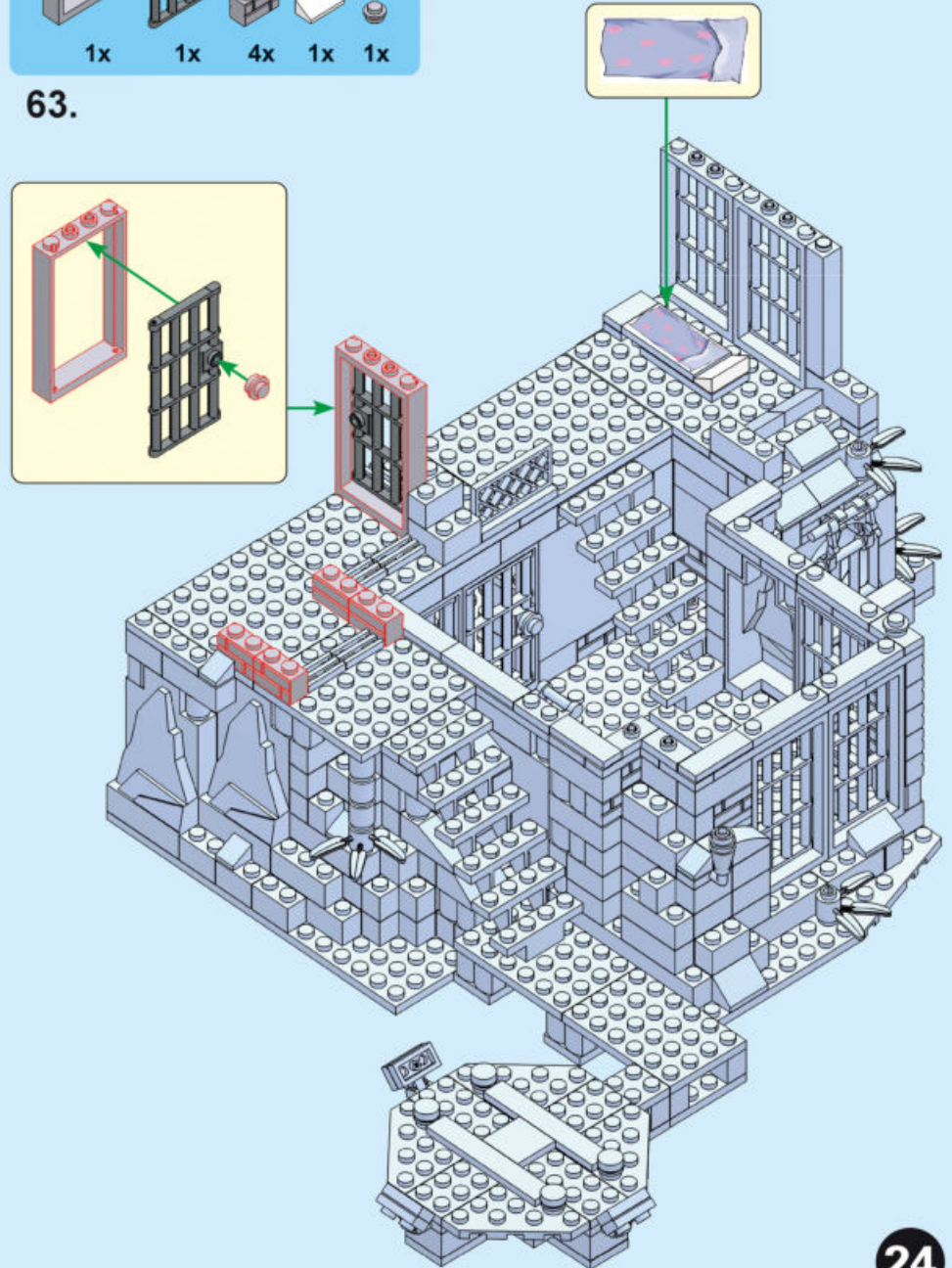
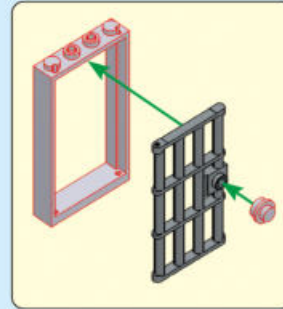



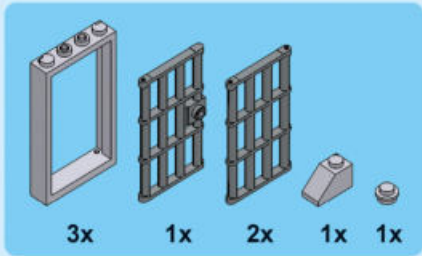

64.

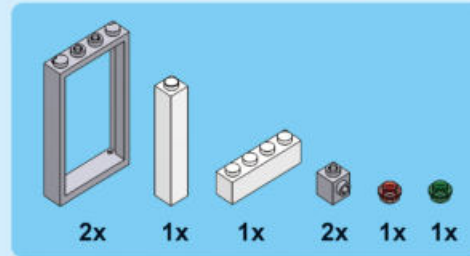
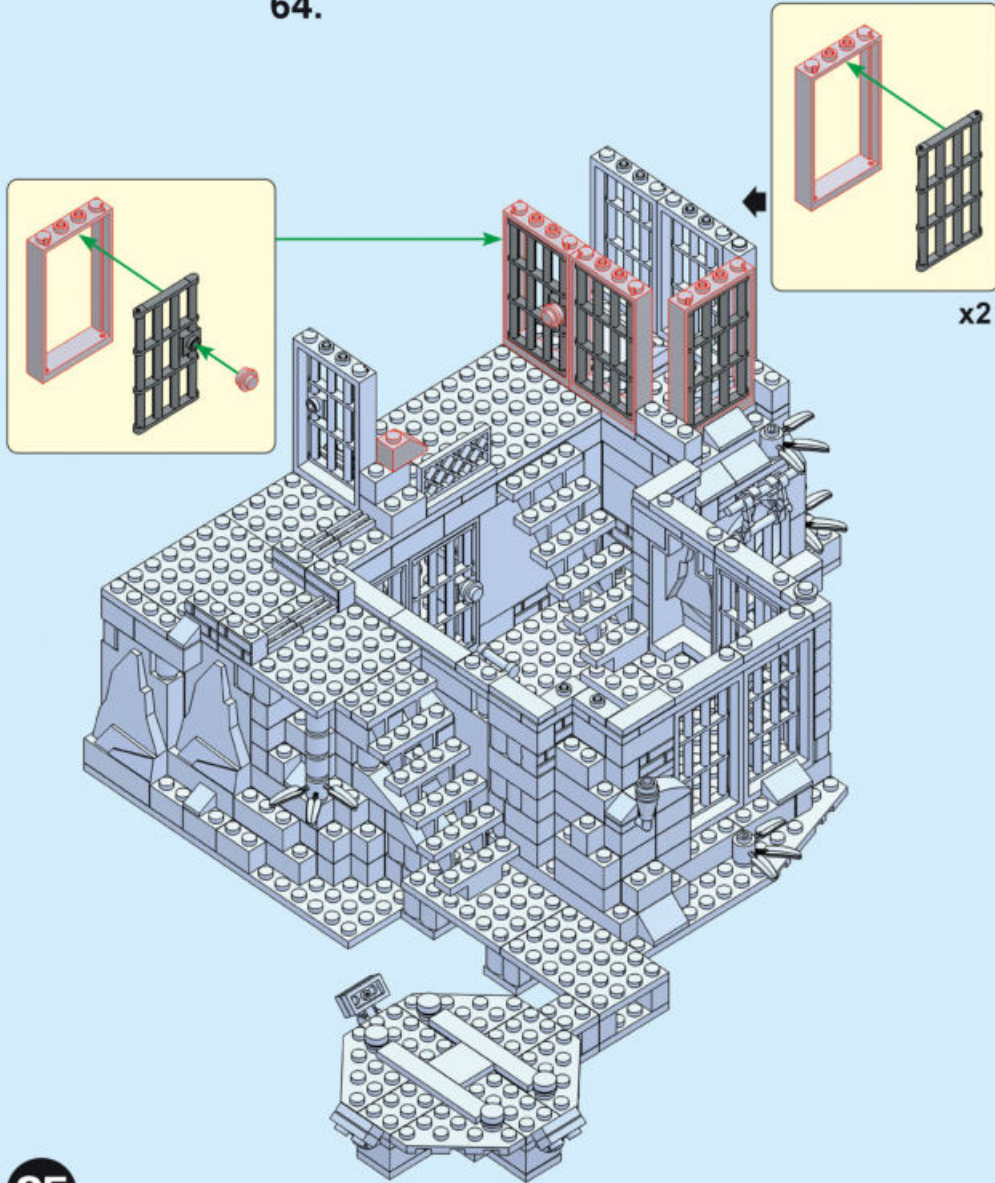

65.

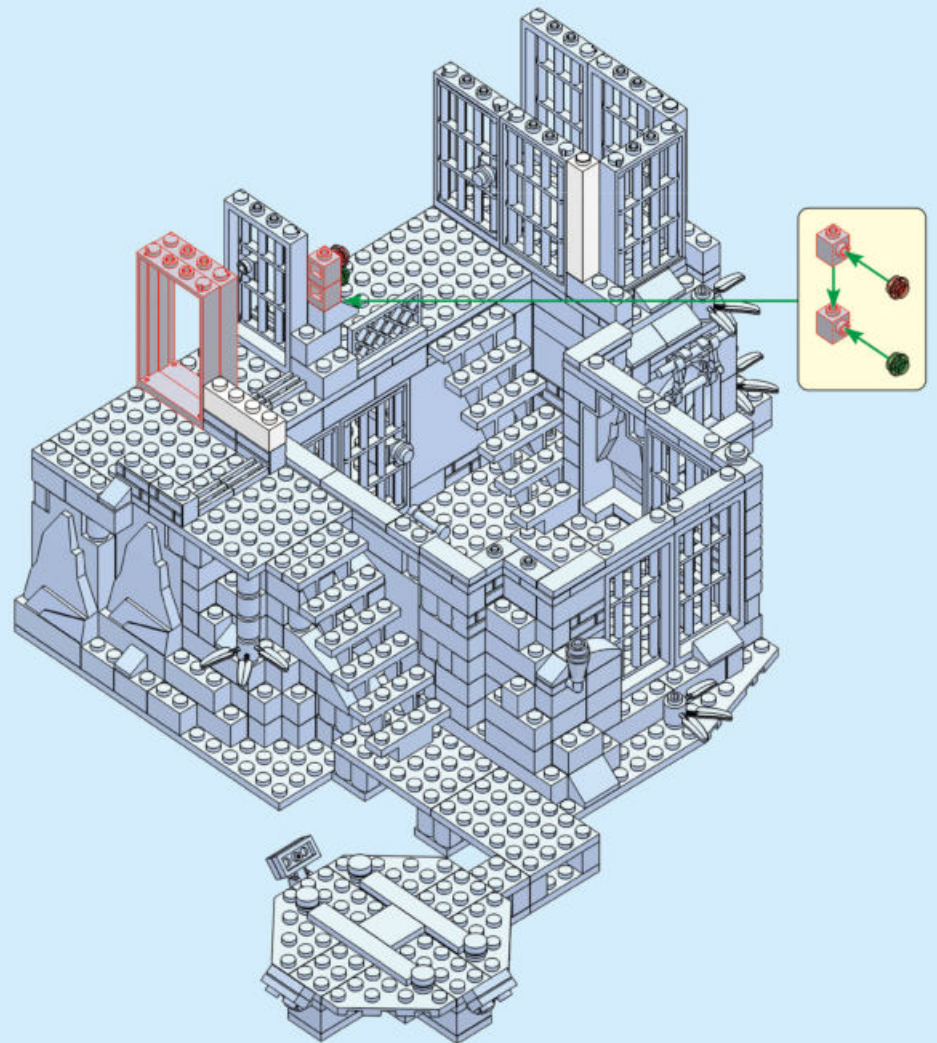



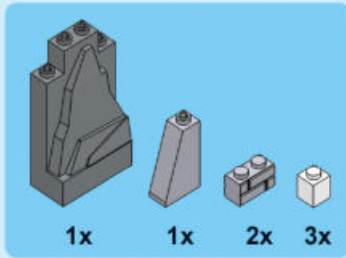

66.

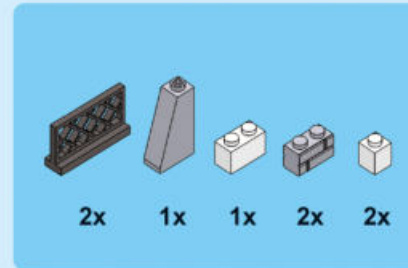
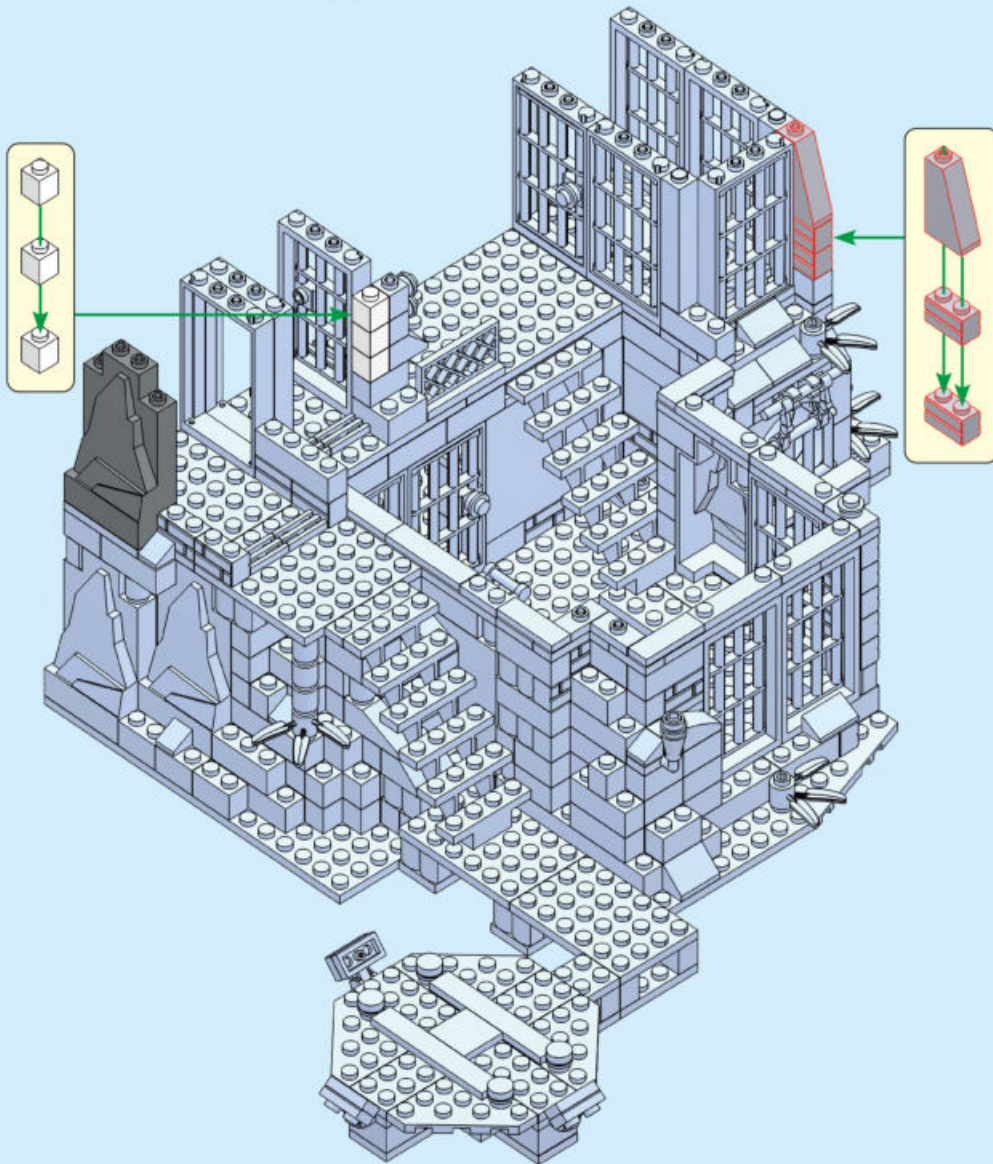

67.

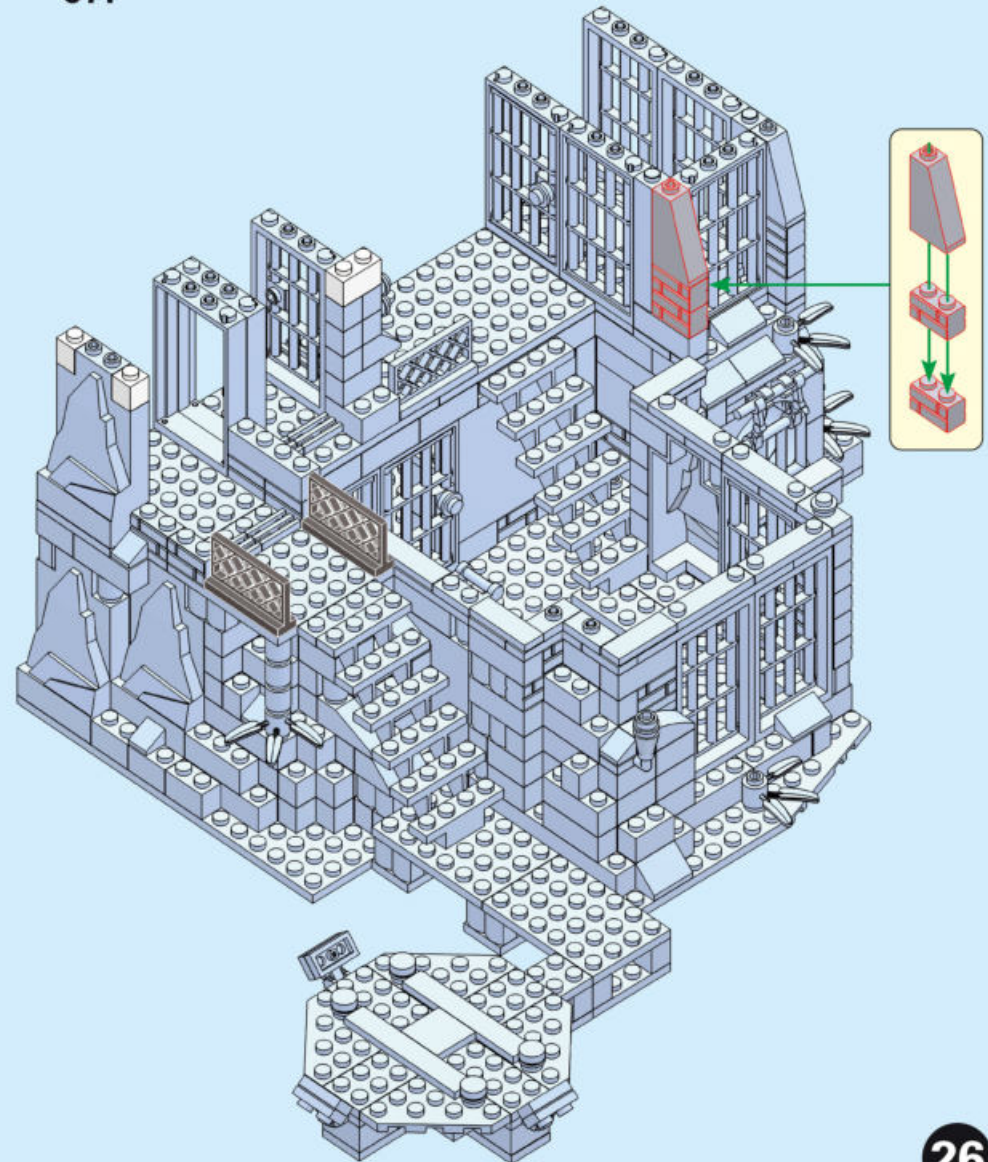



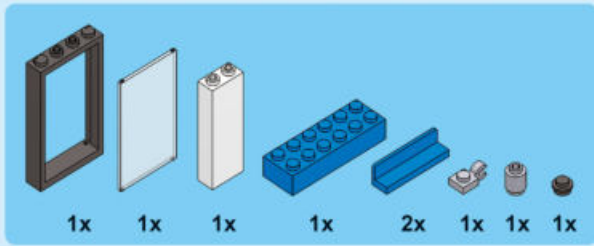

68.

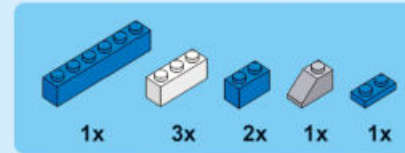
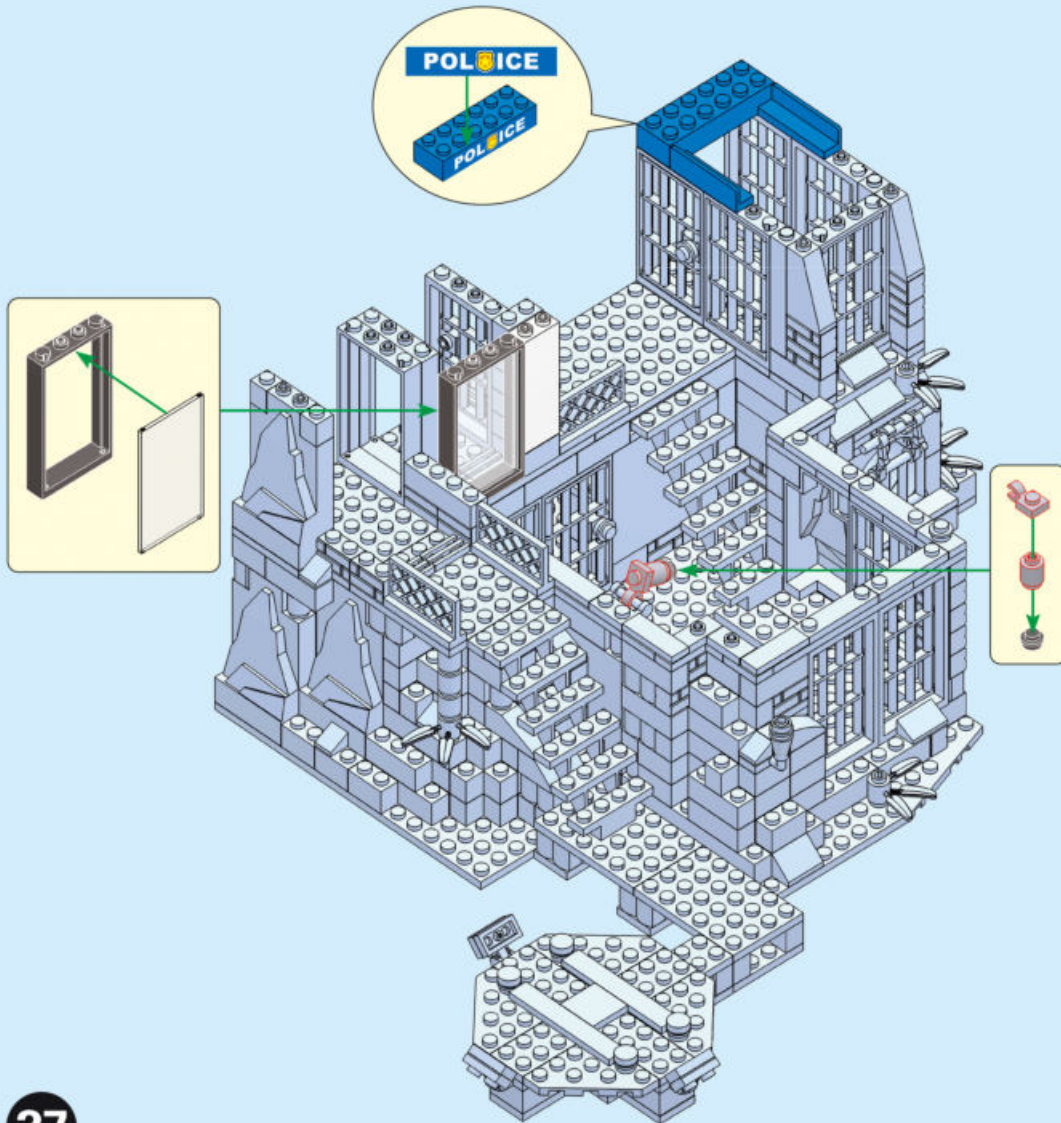

69.

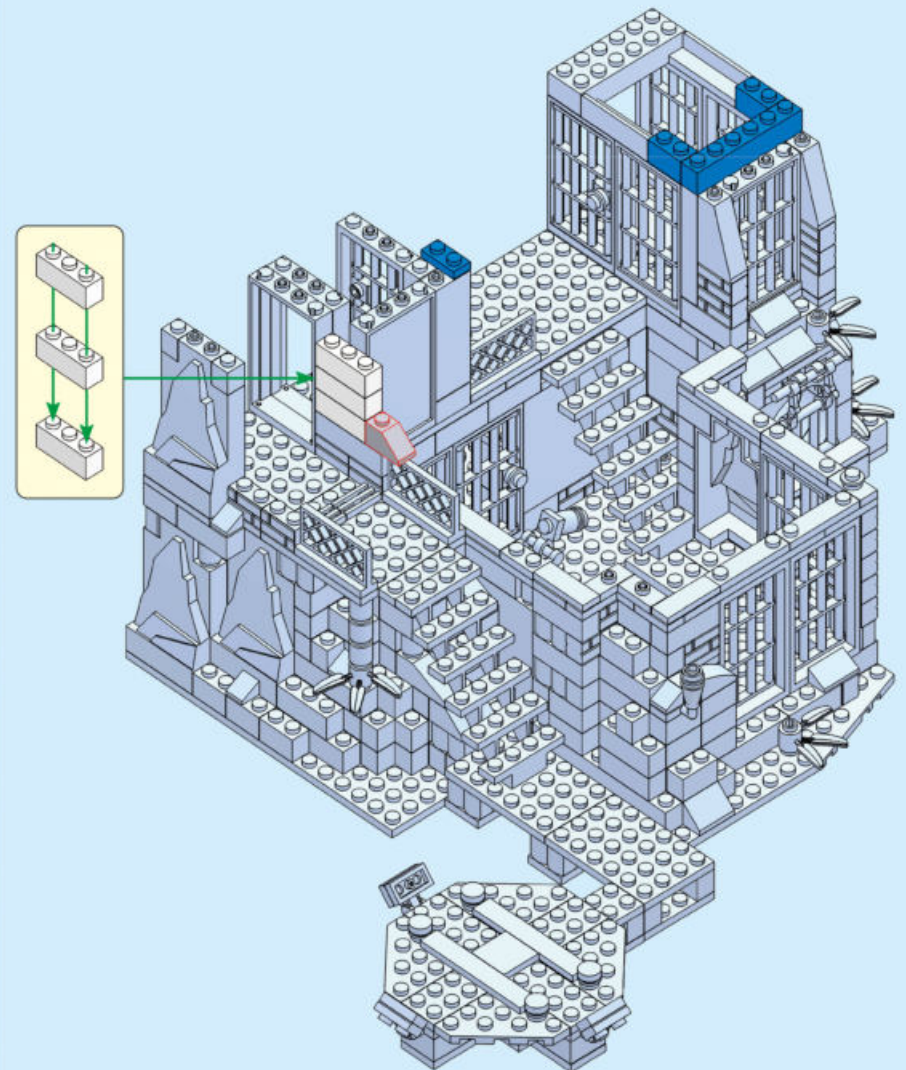



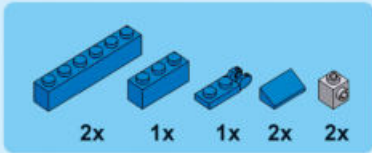

70.

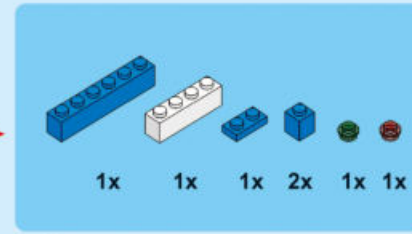
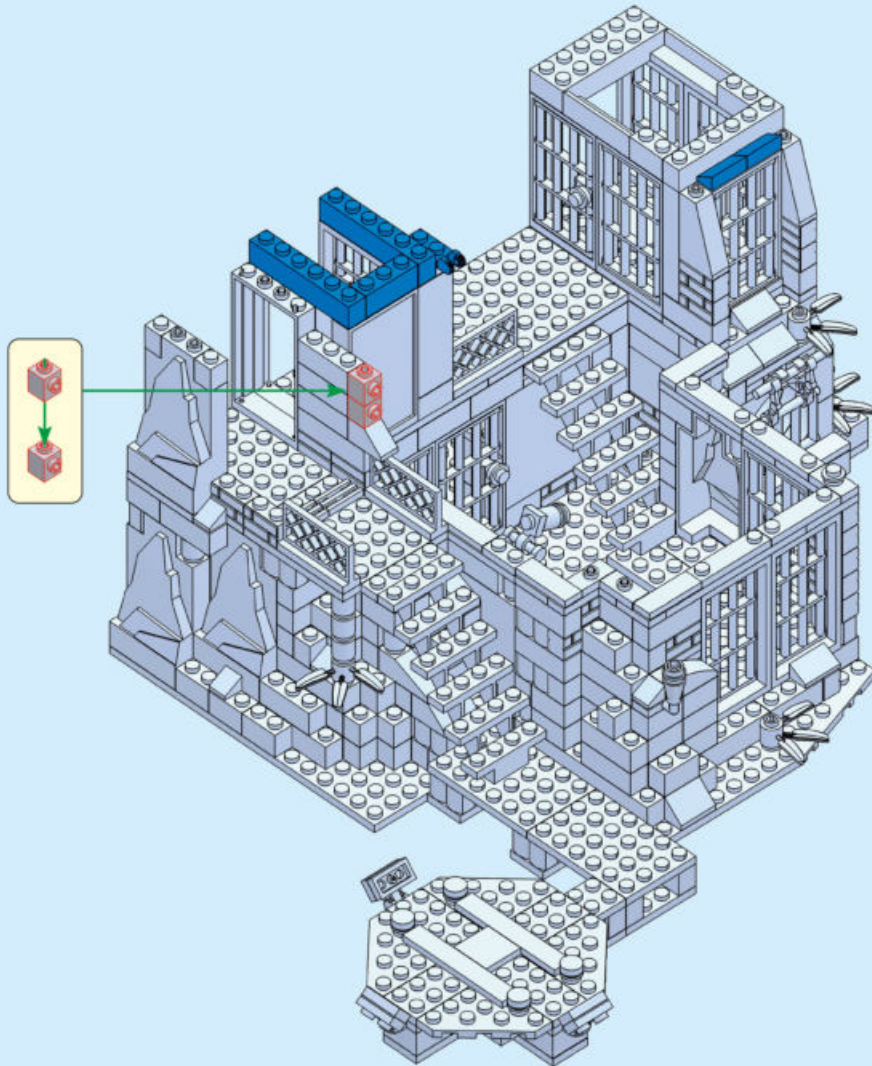

71.

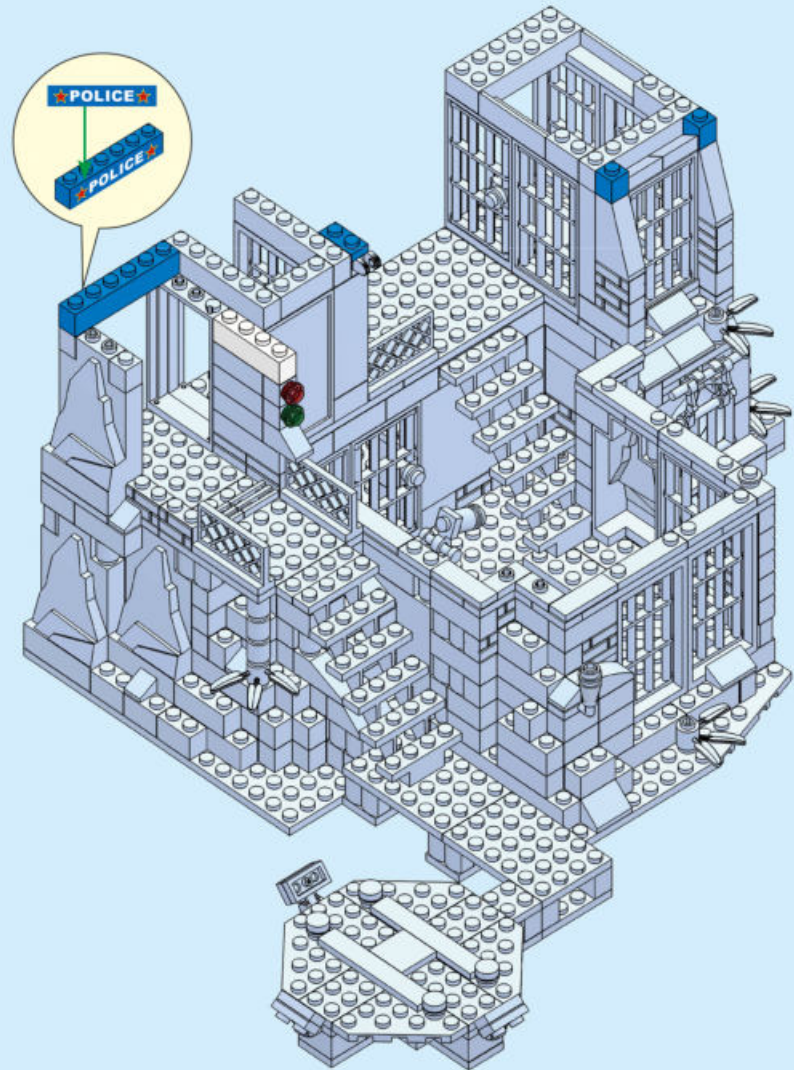



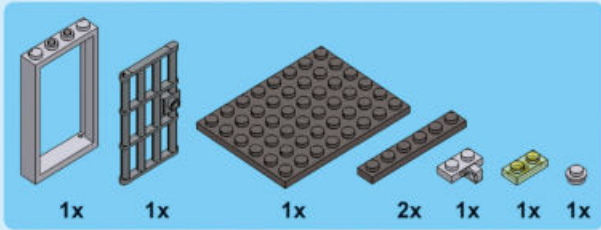

72.

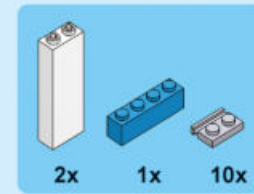
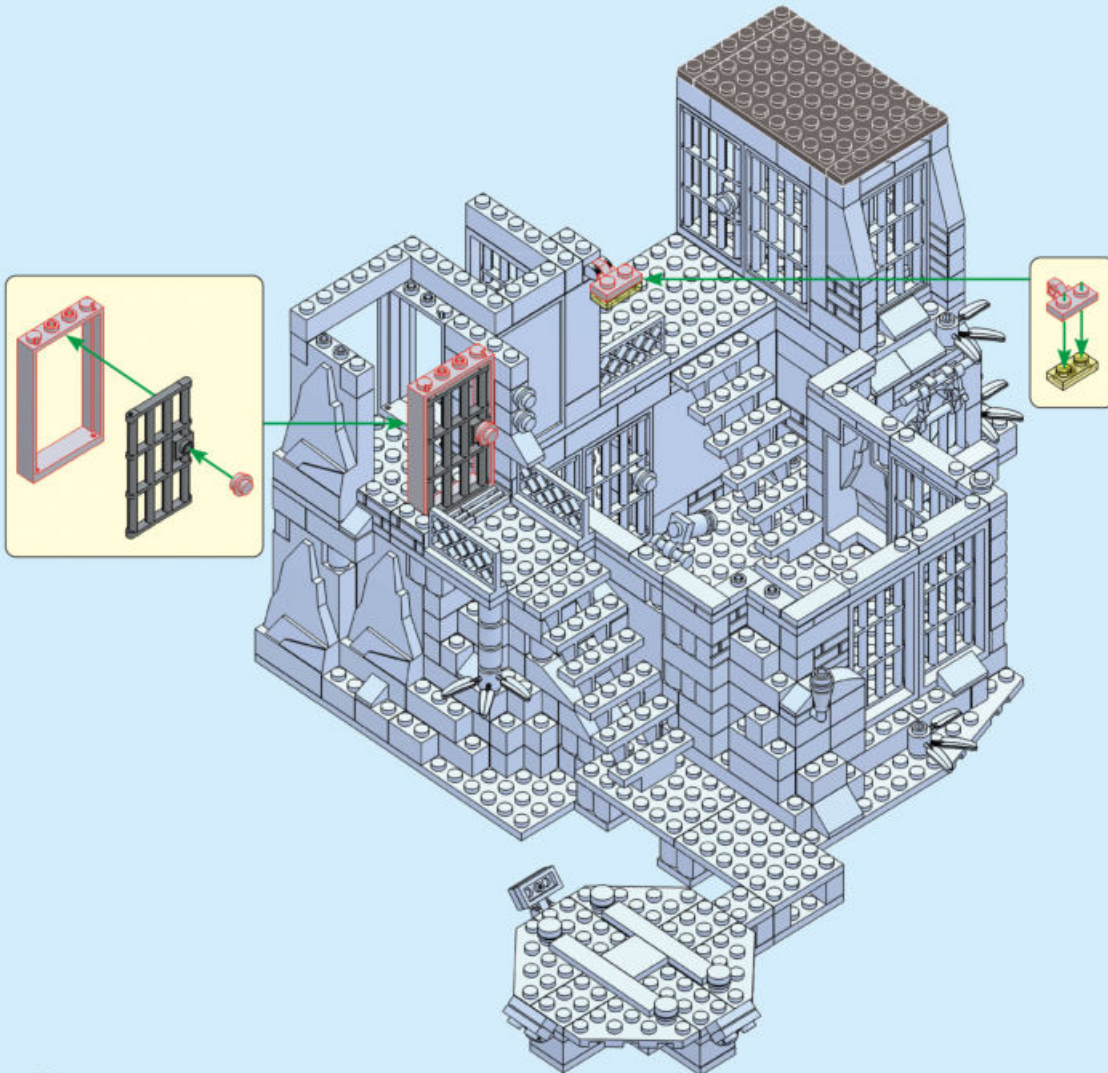

73.

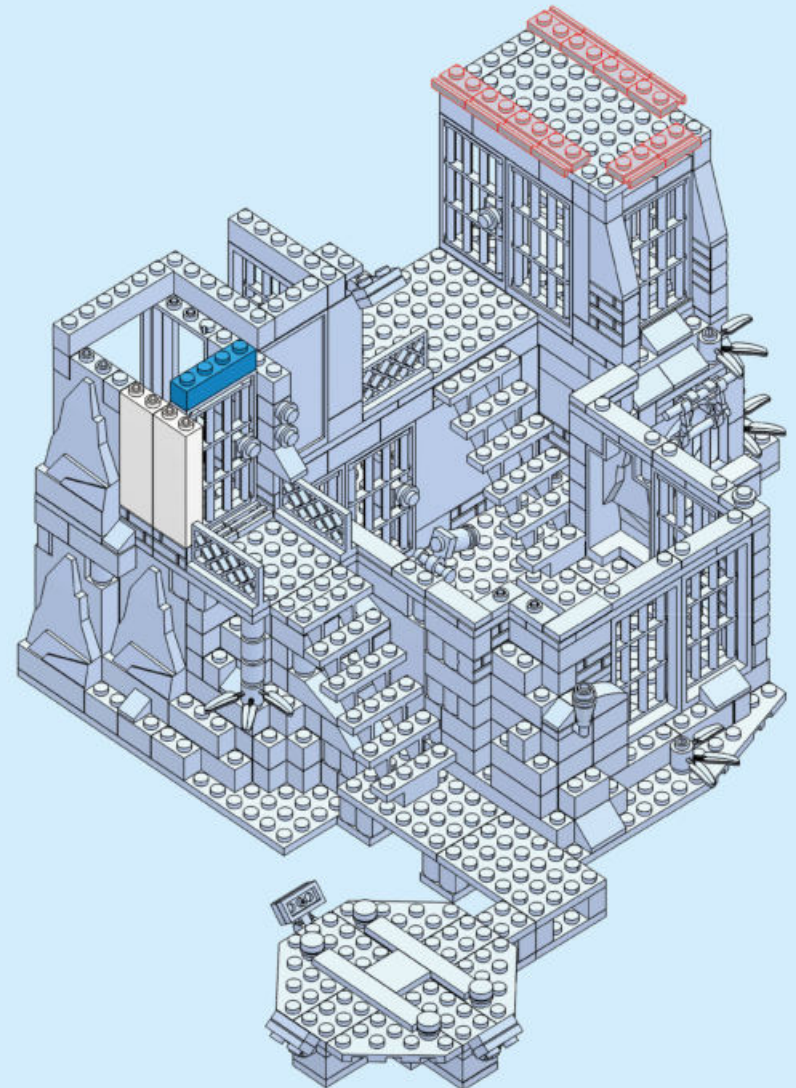



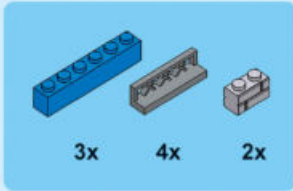

74.

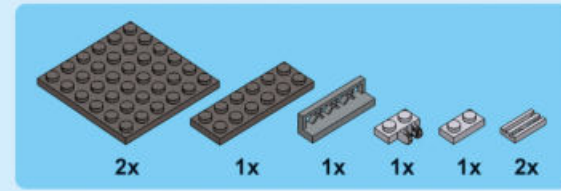
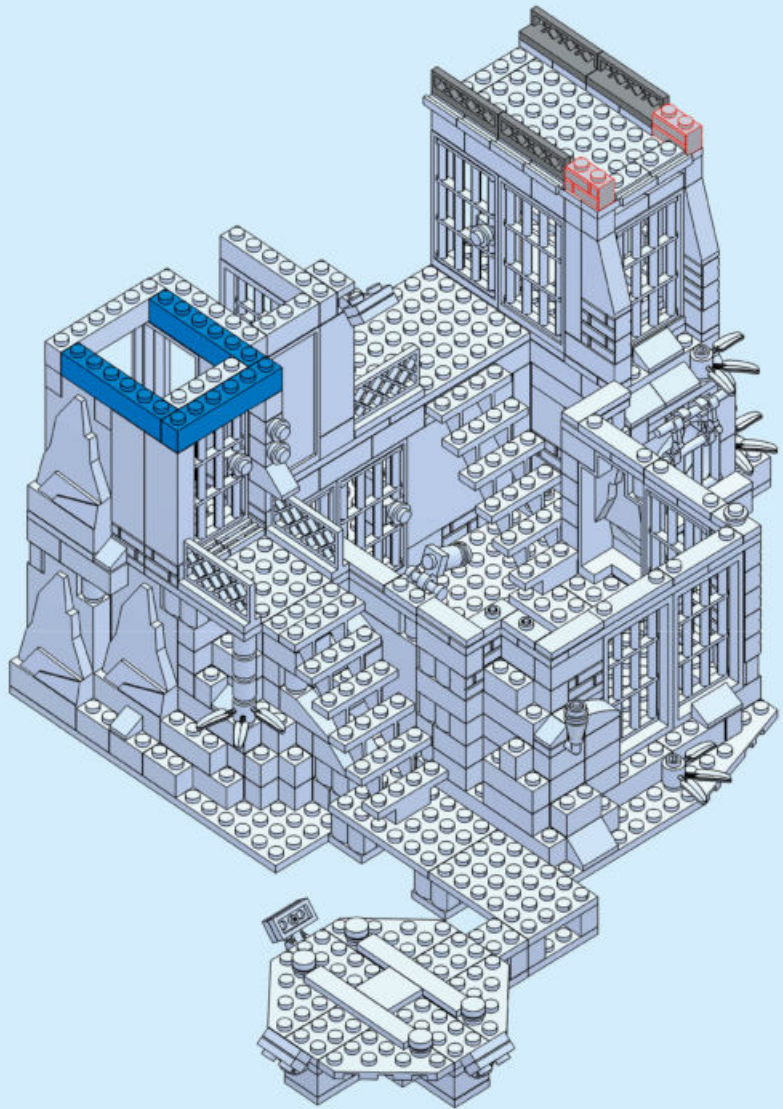

75.

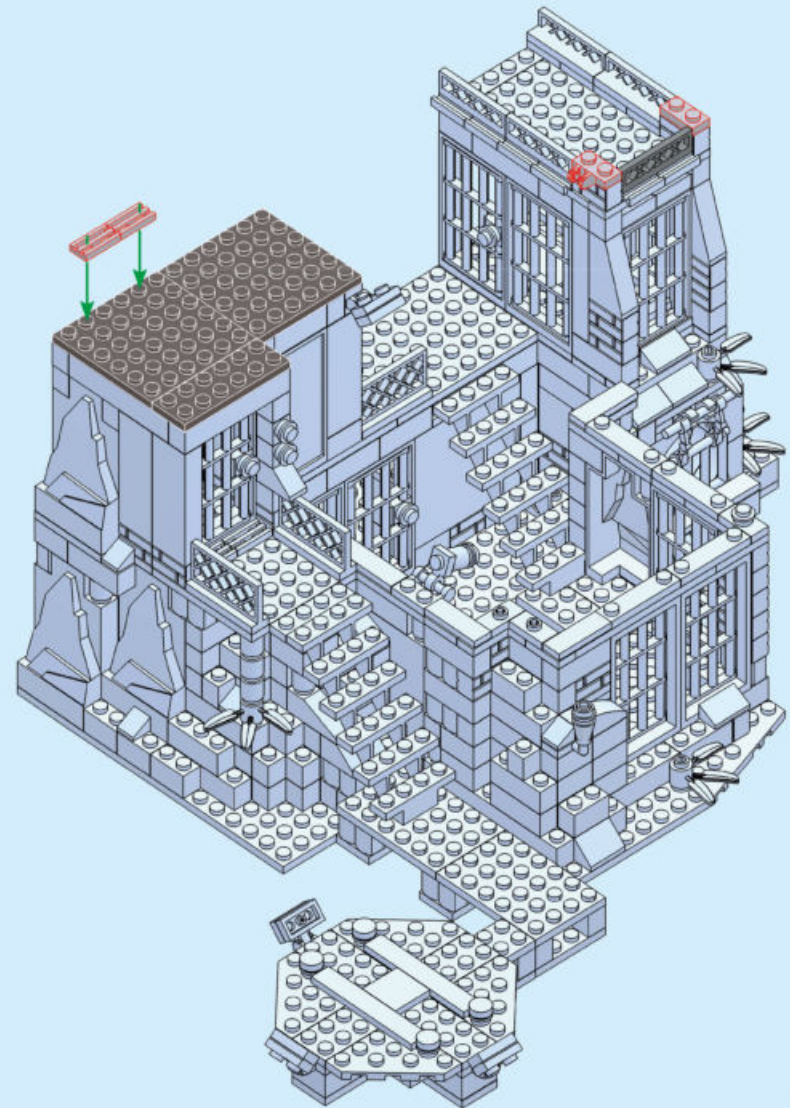



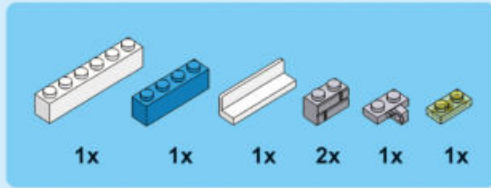

76.

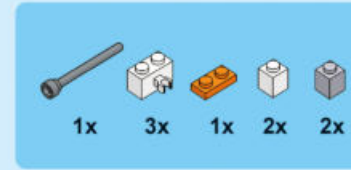
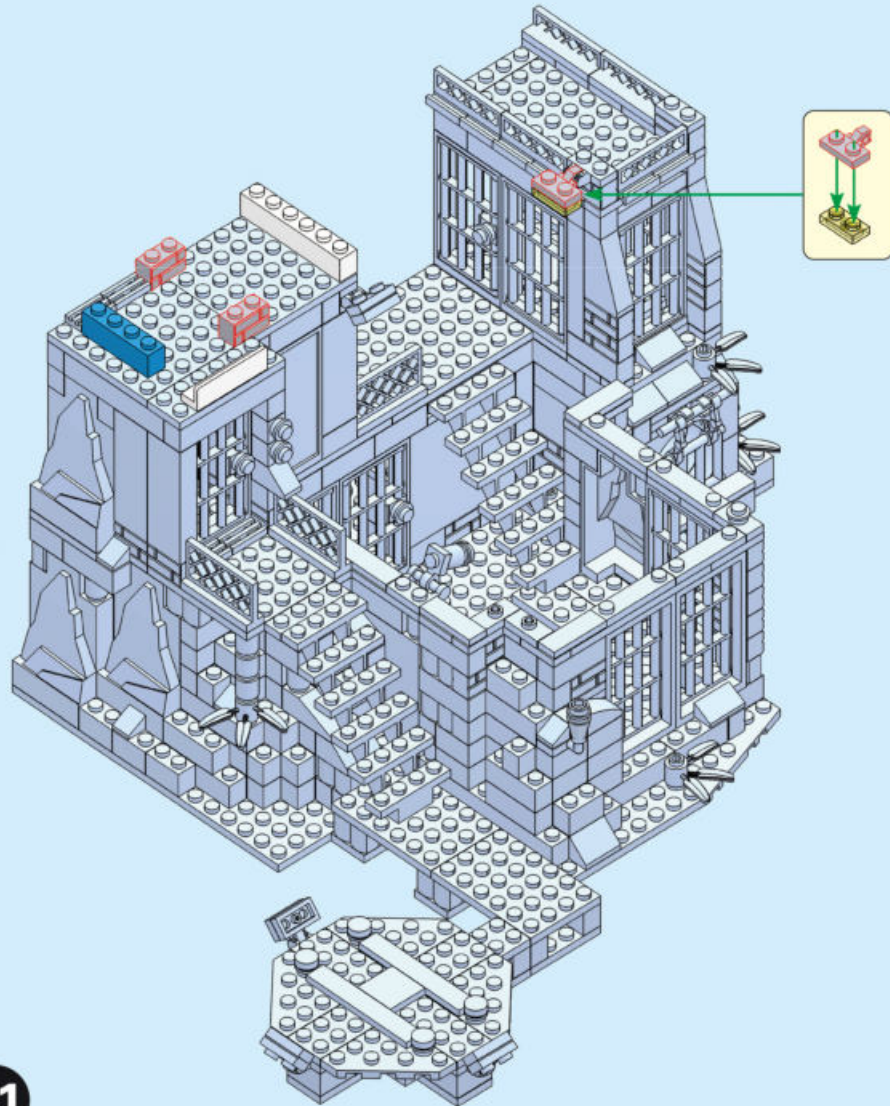

77.

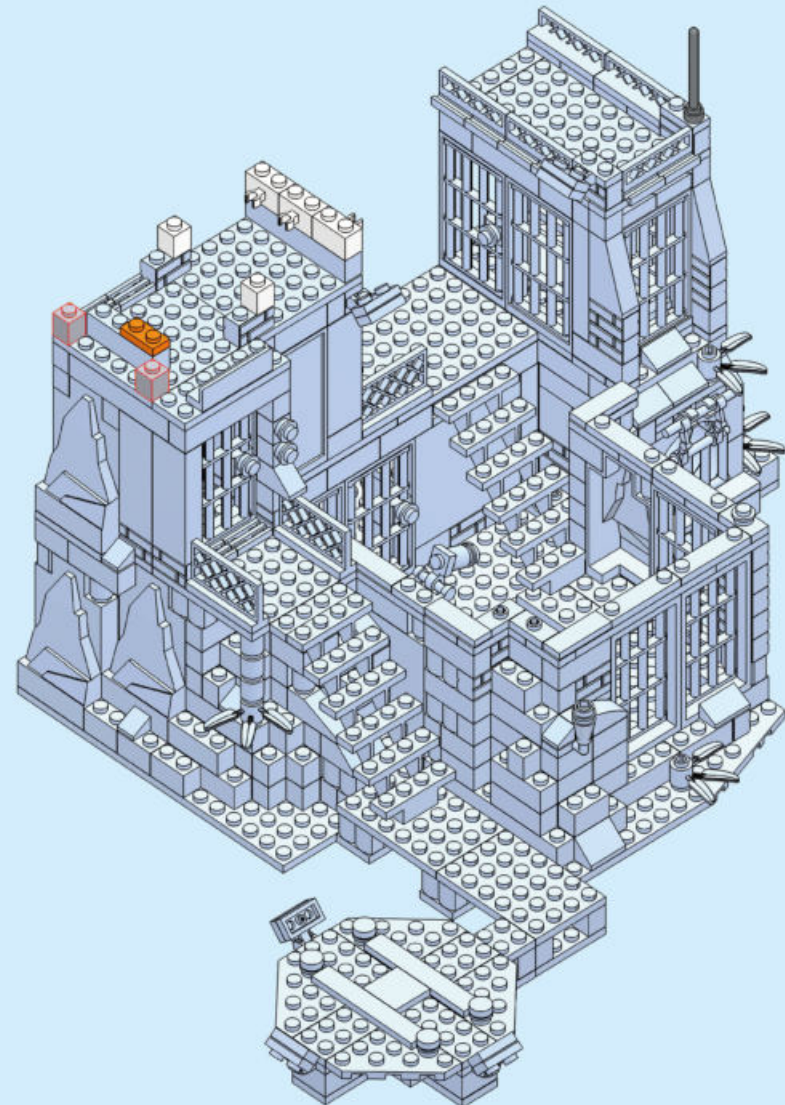



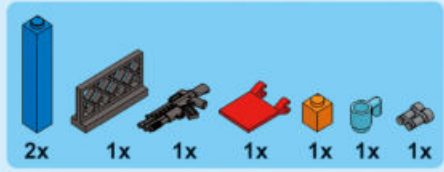

78.

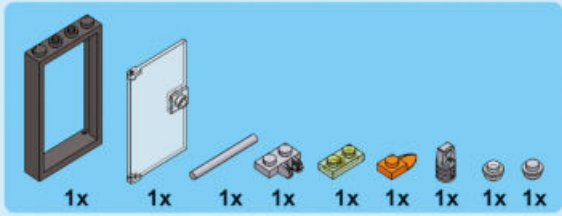
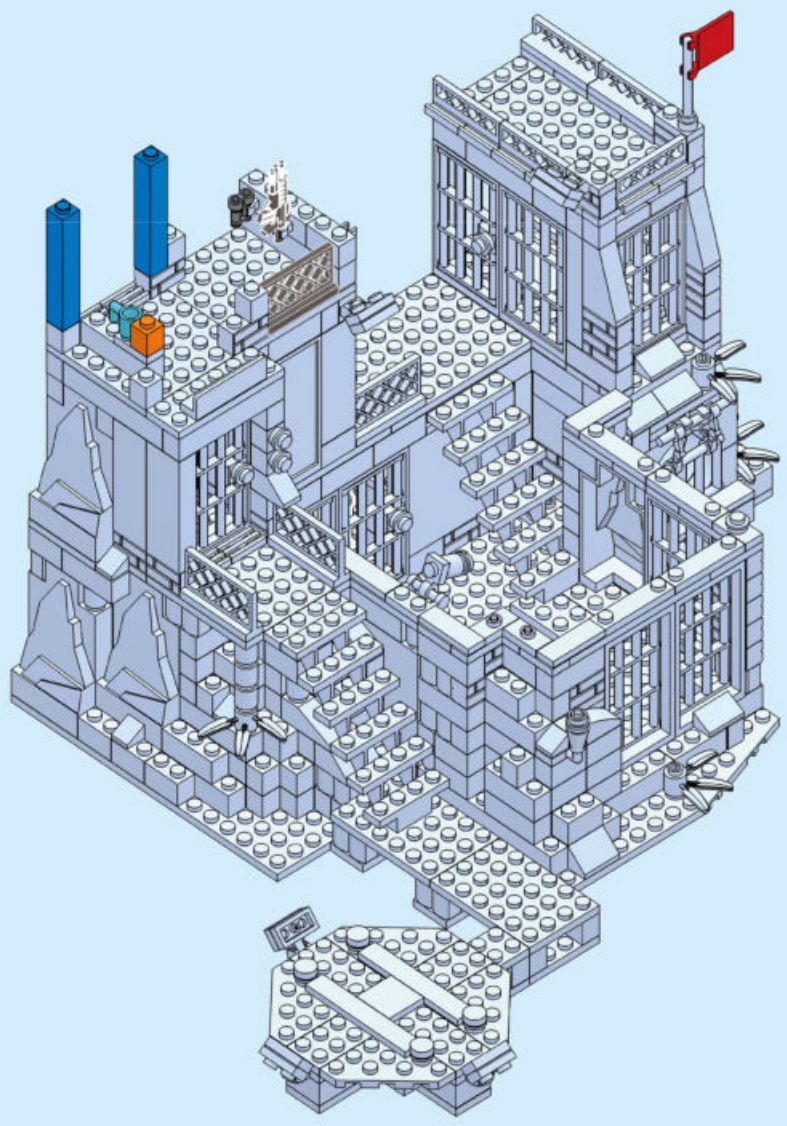

79.

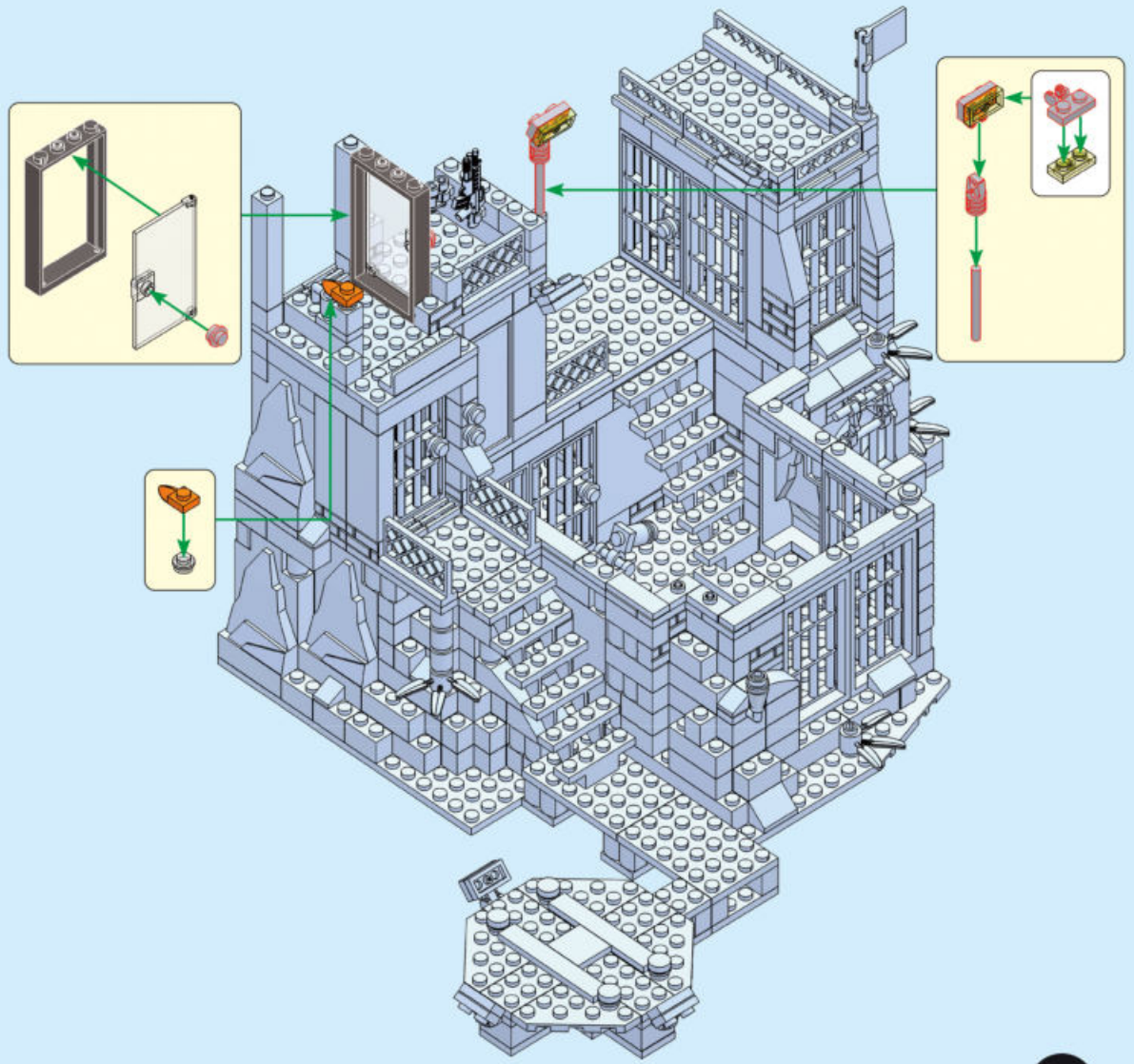



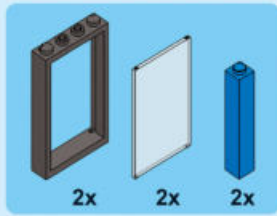

80.

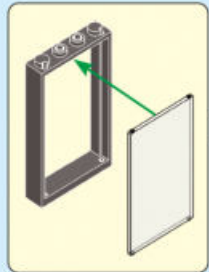

x2

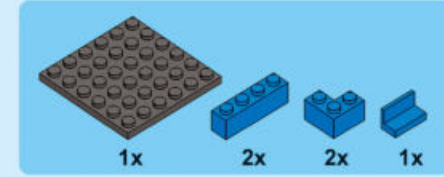
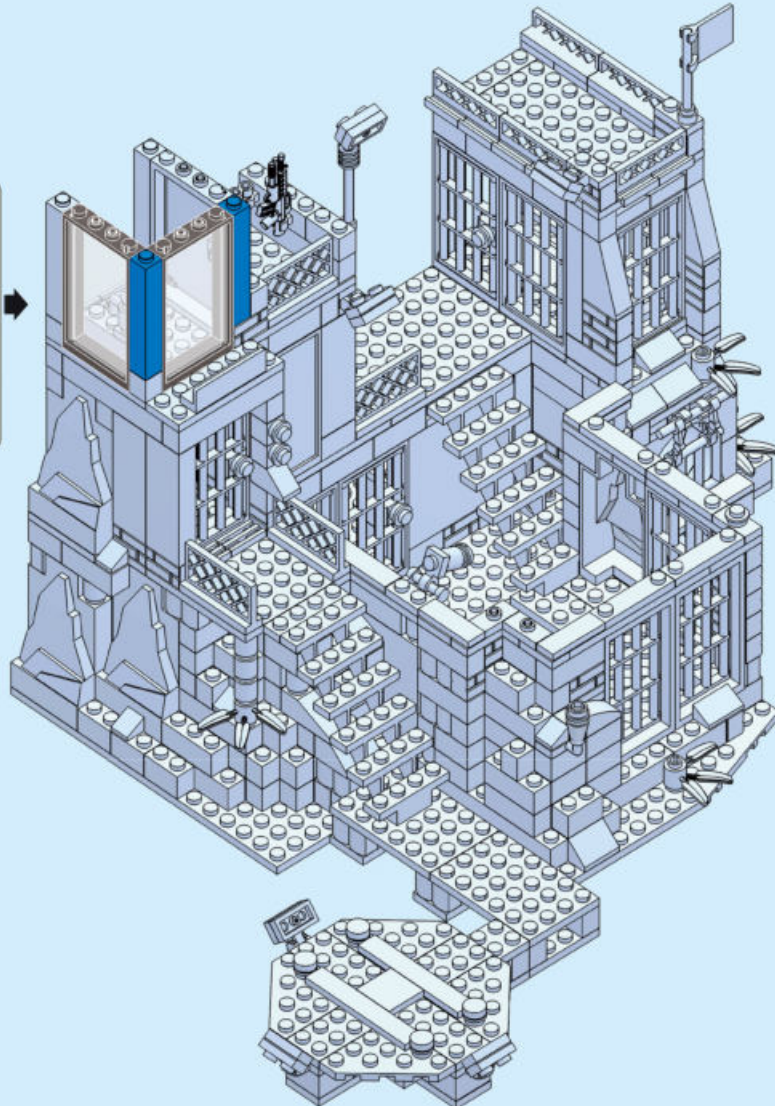

81.

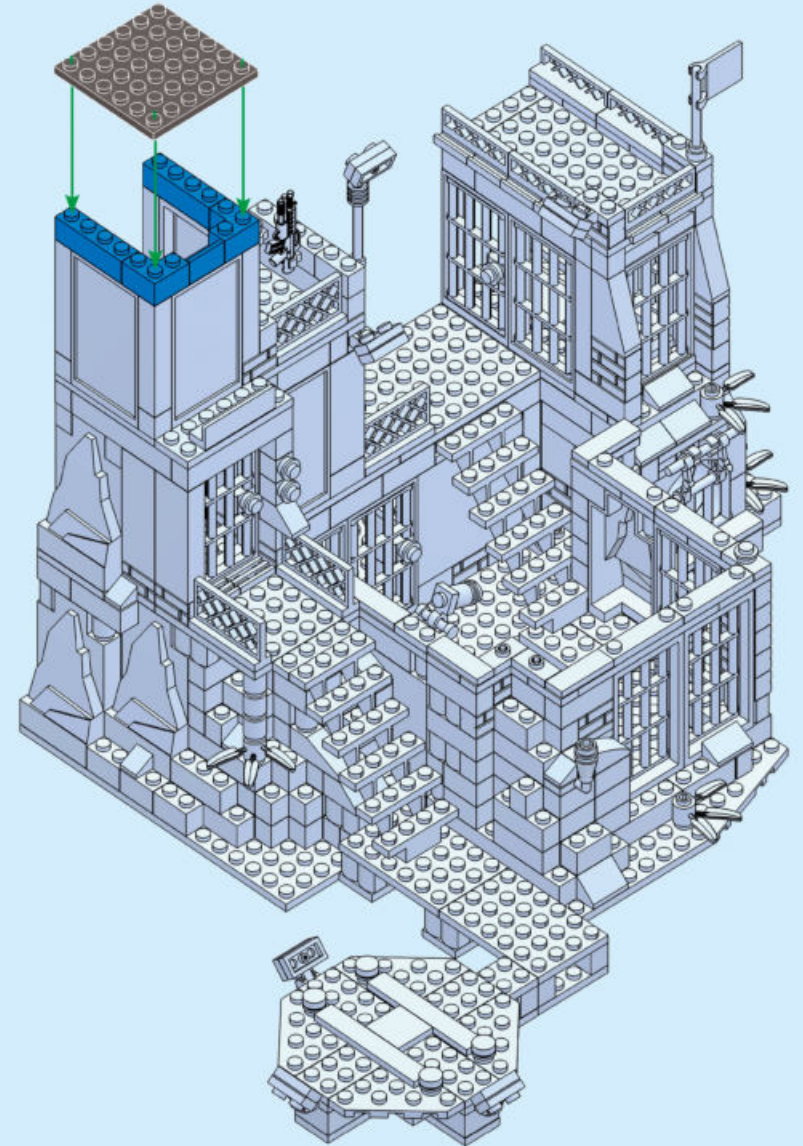



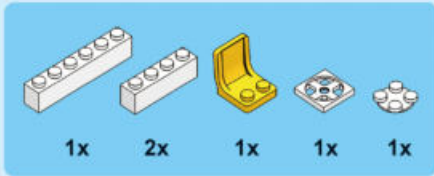

82.

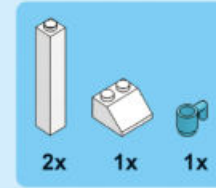
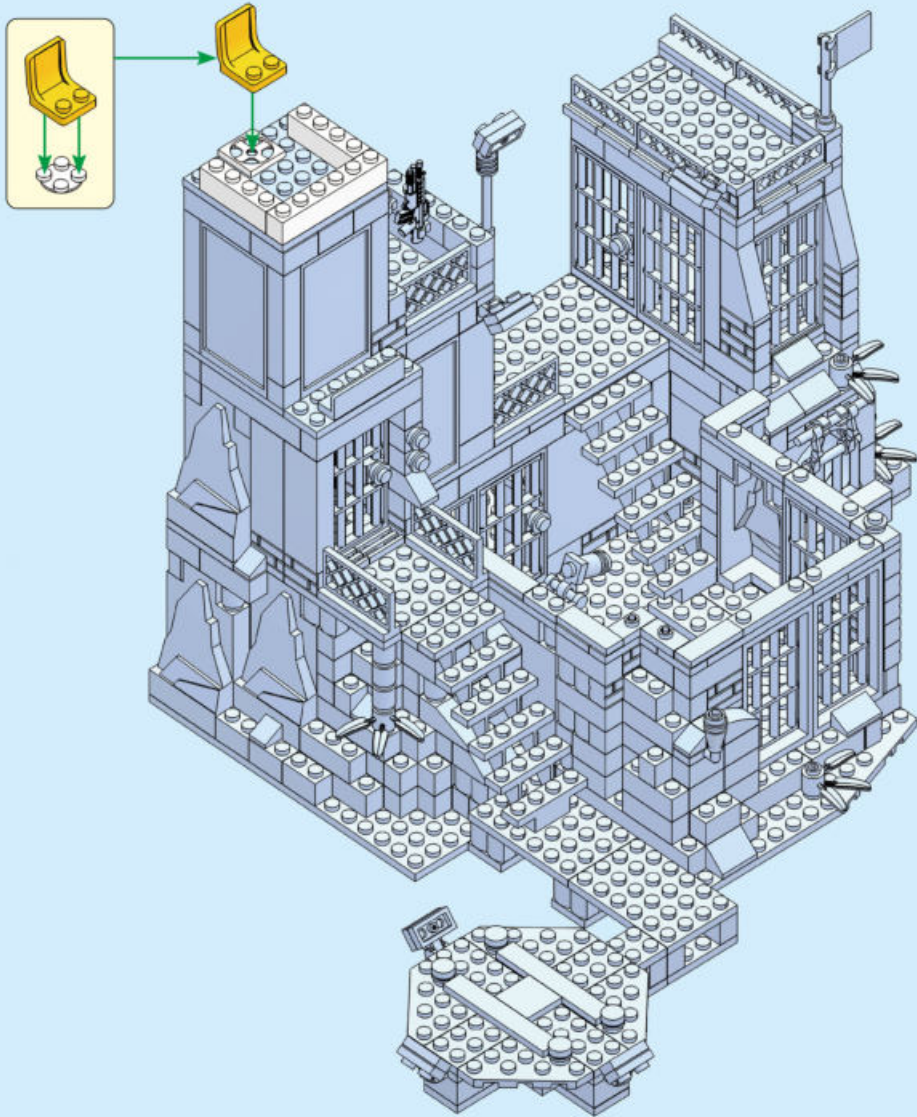

83.

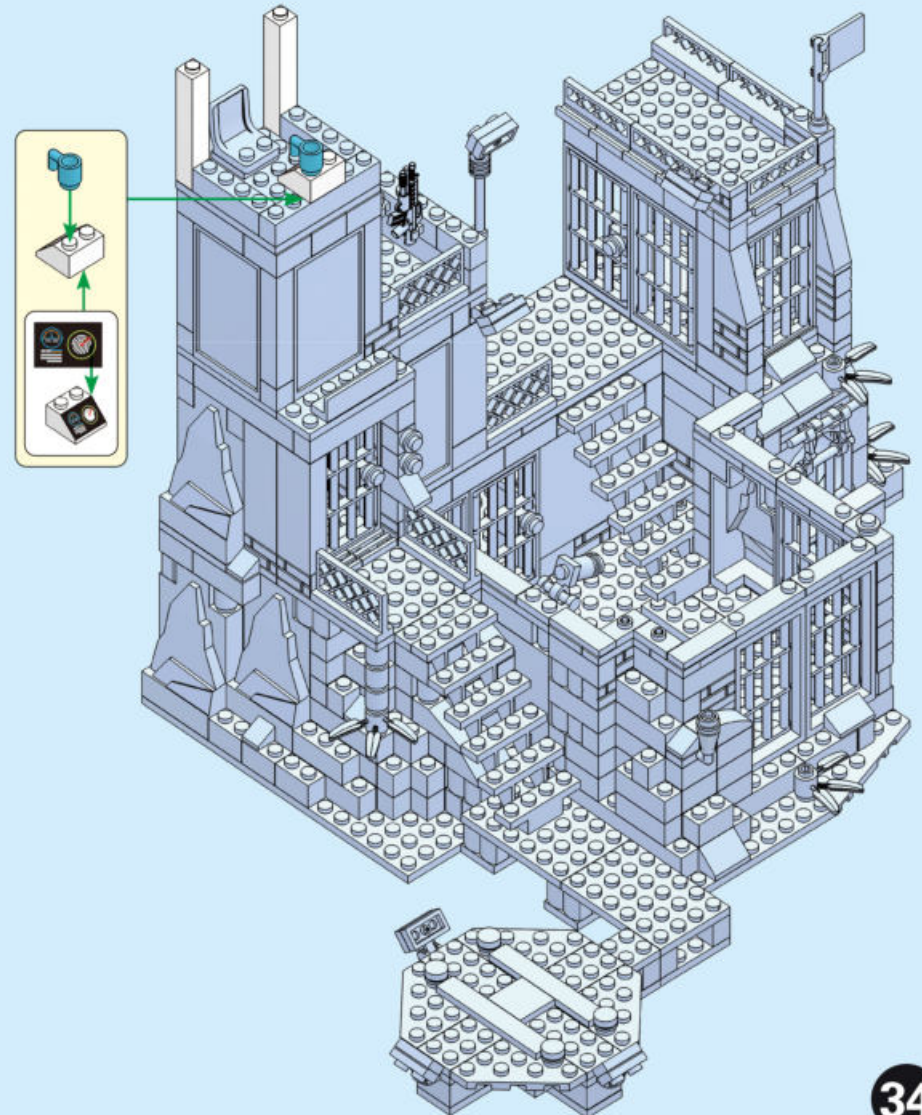



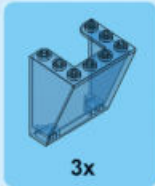

84.

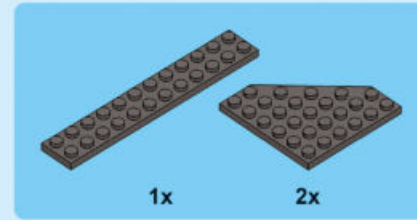
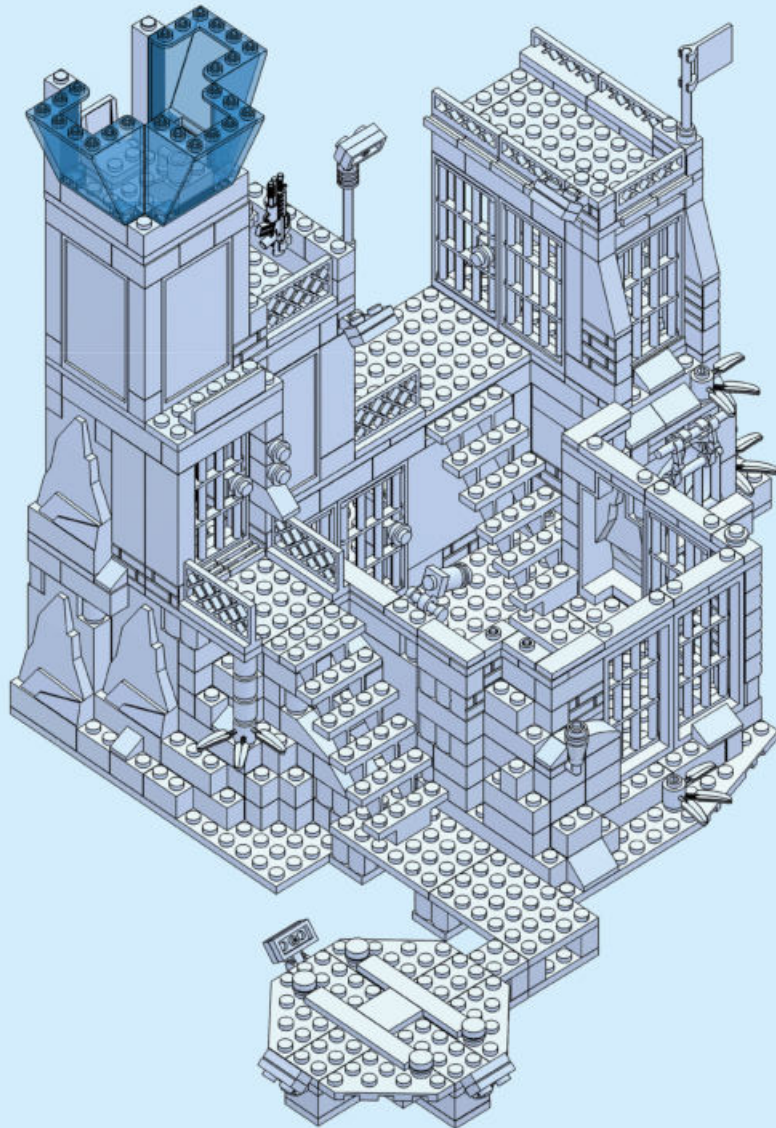

85.

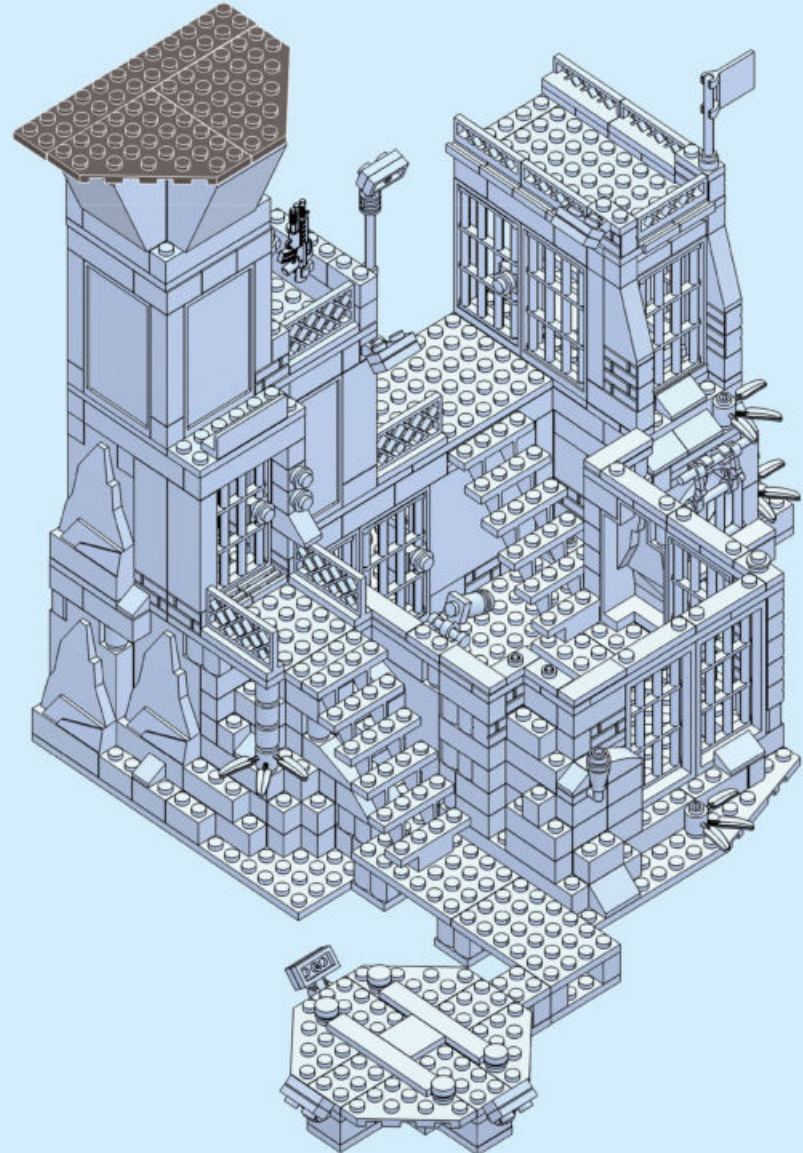



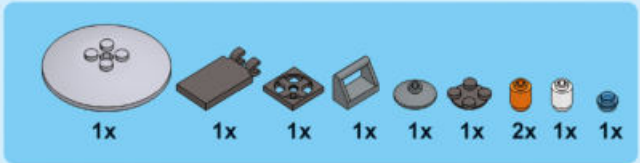

86.

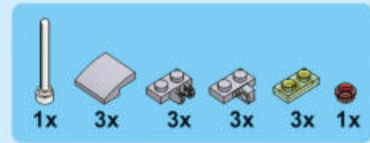
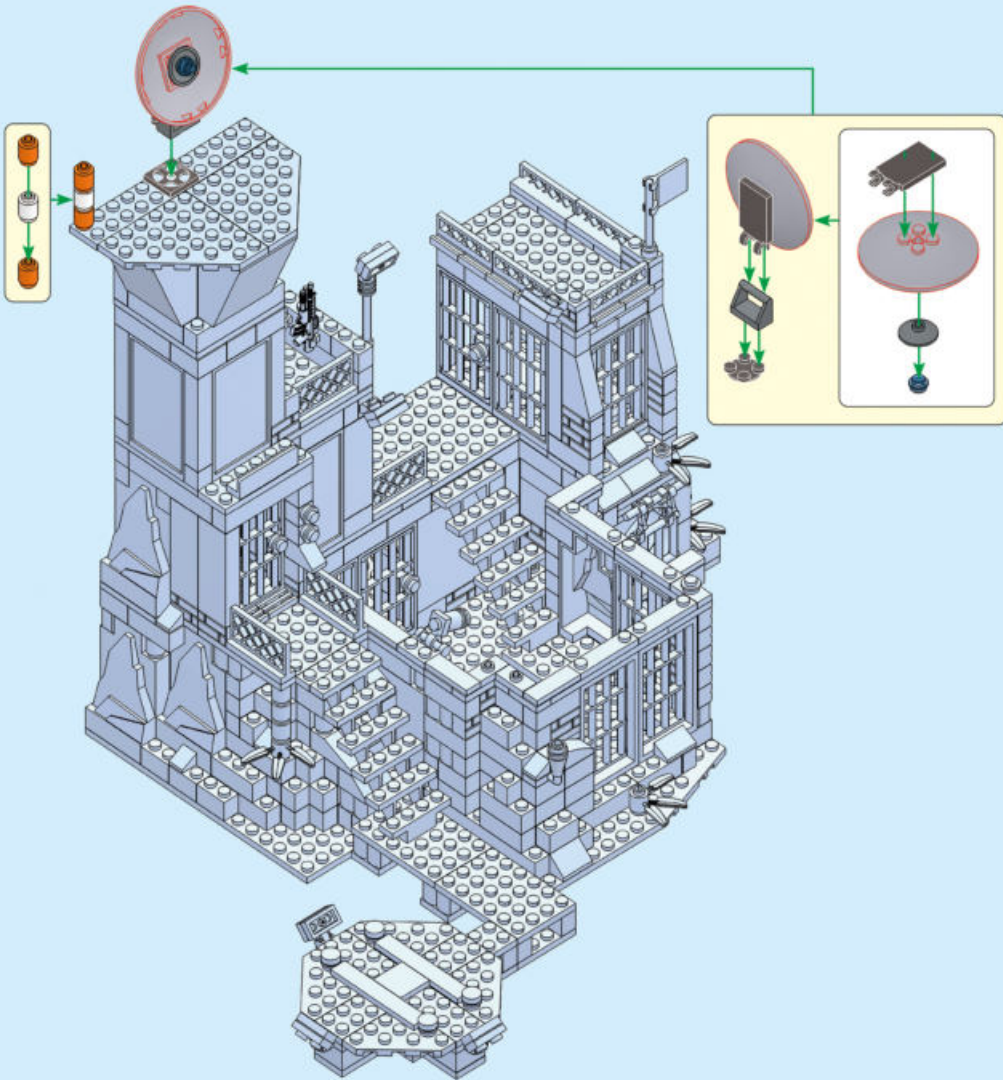

87.

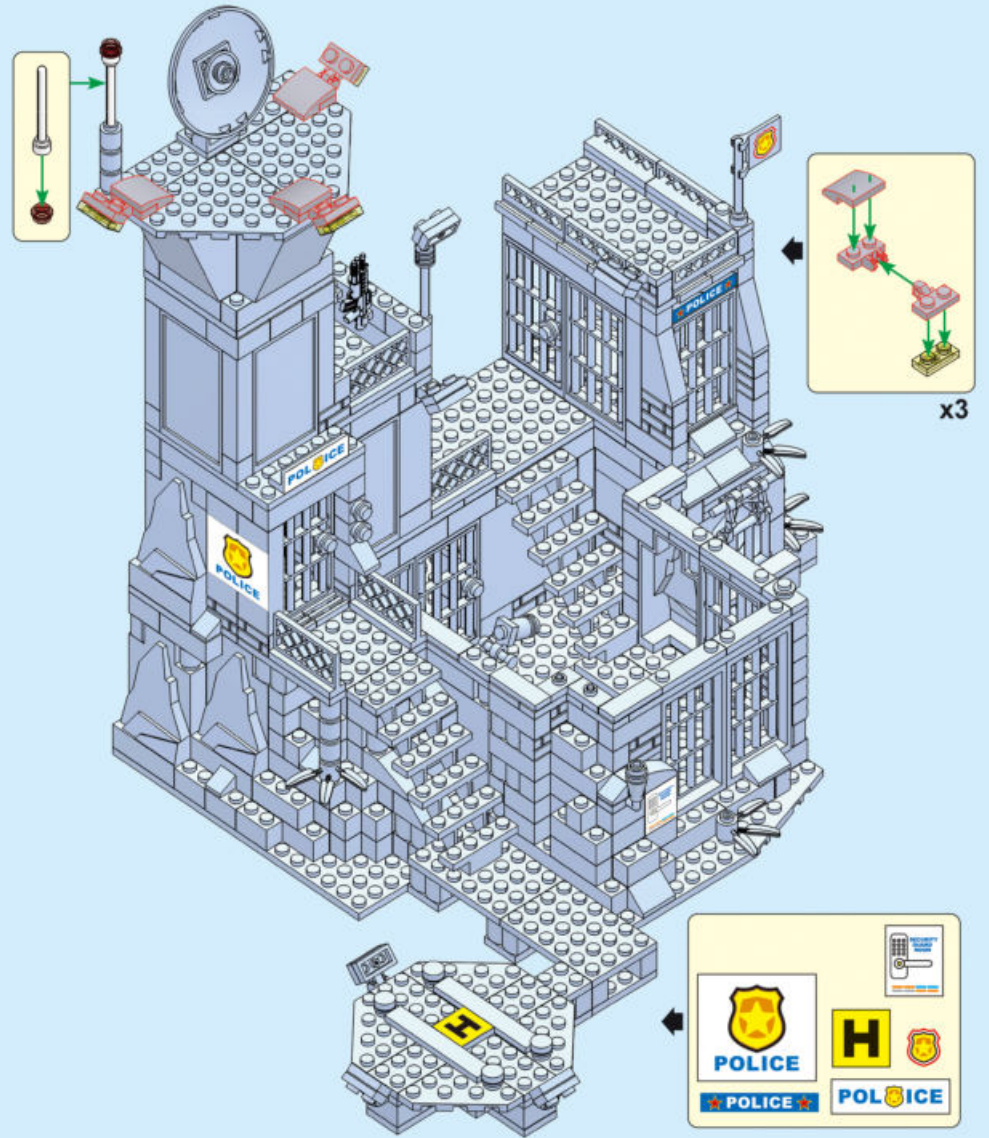



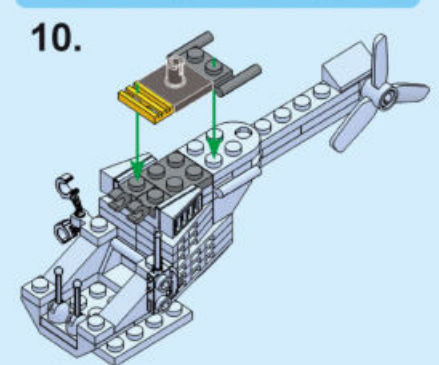
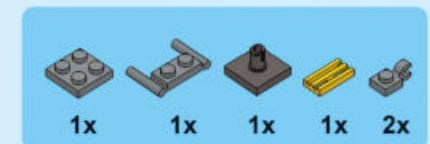
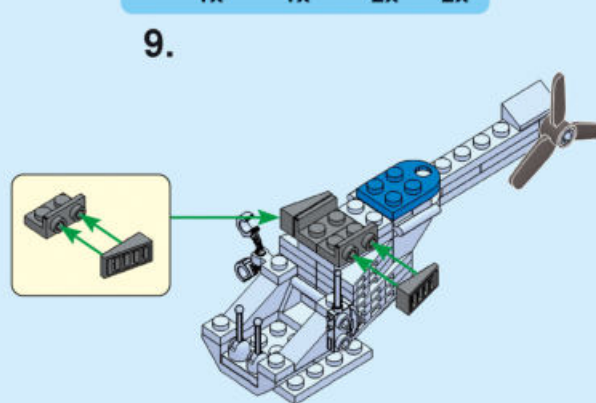
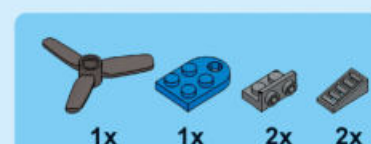
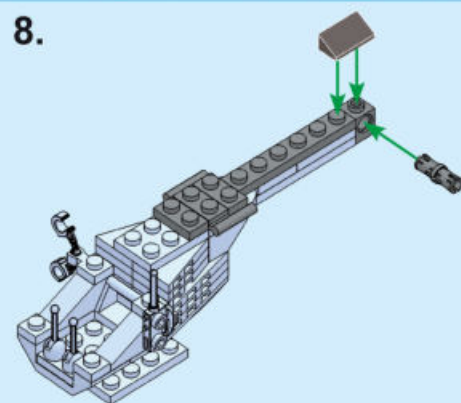
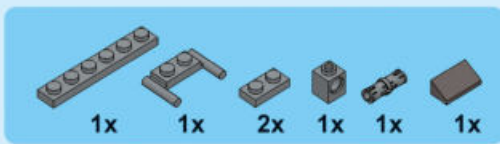
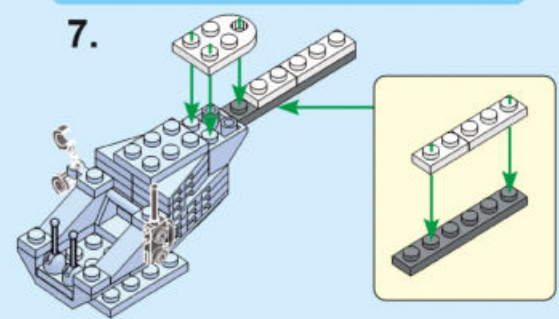
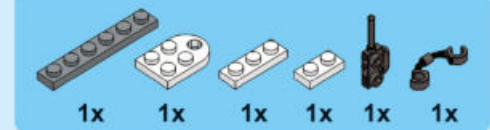
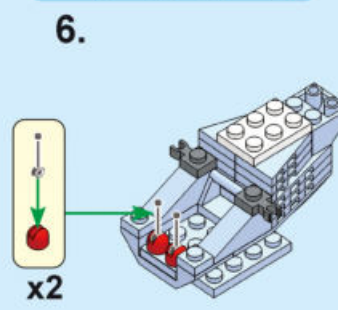
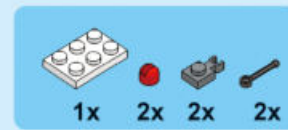
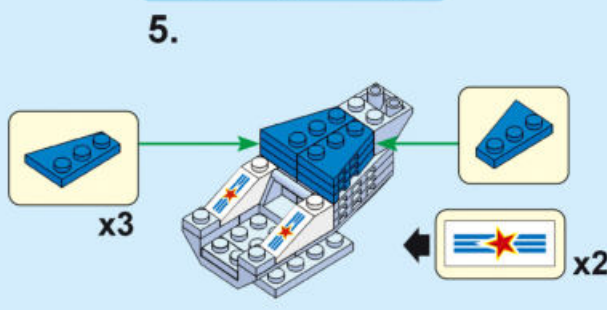
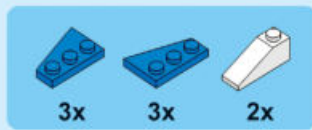
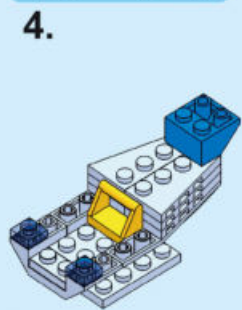
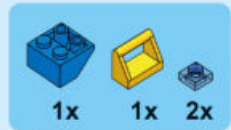
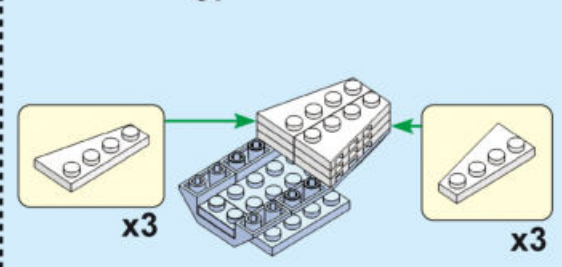
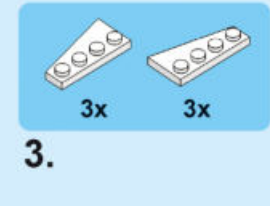
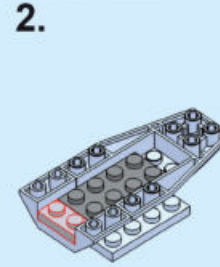
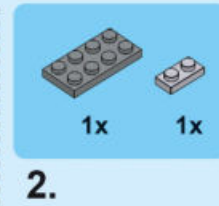
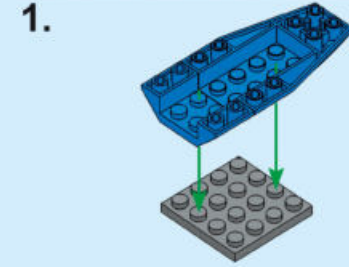
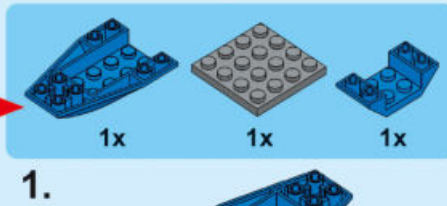



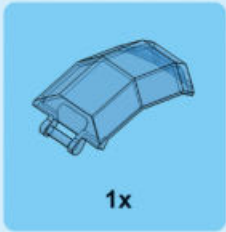

11.

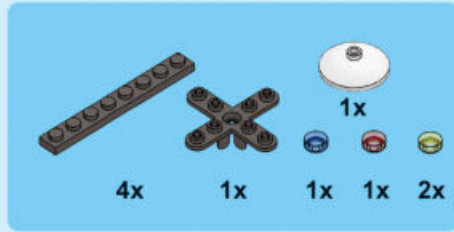
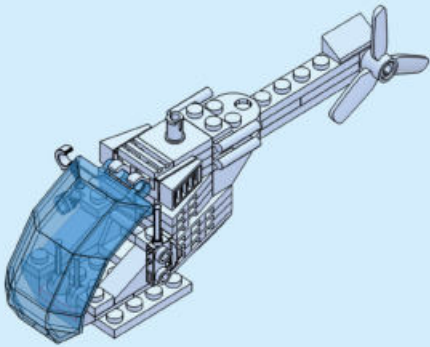

12.

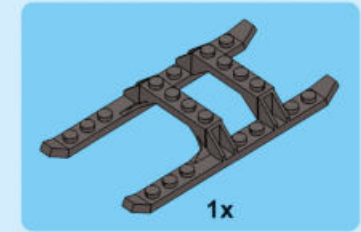
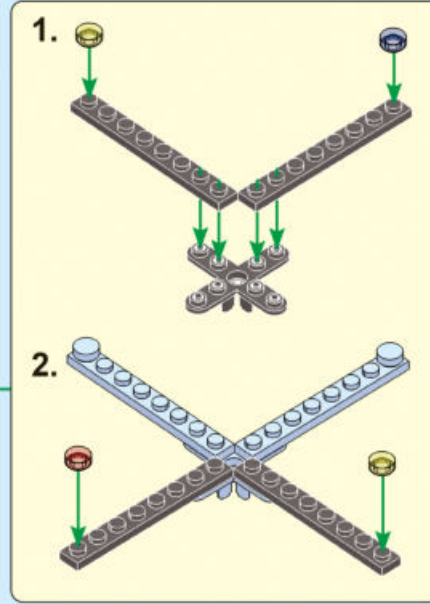
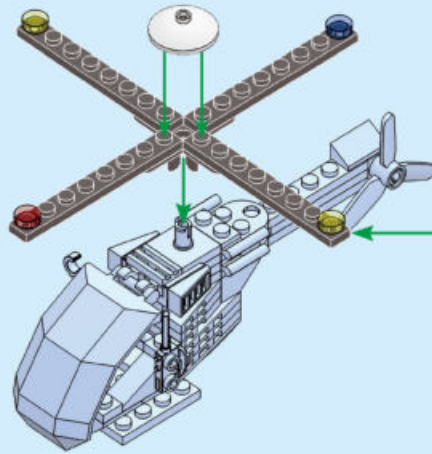

13.

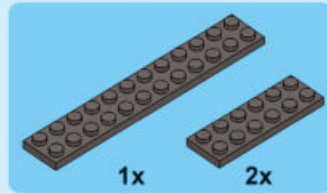
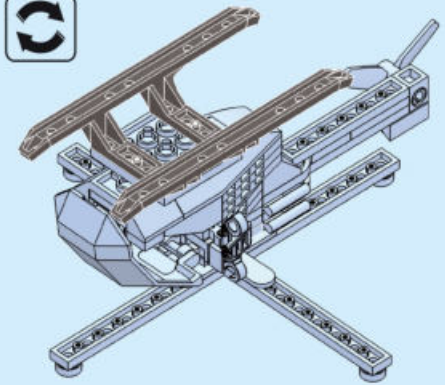

1.



2.

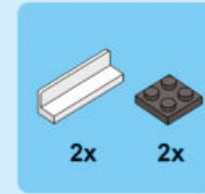

3.

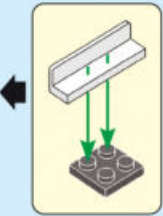
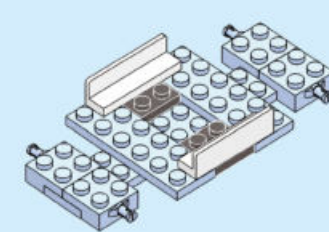
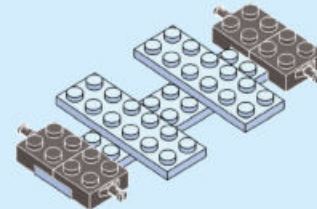
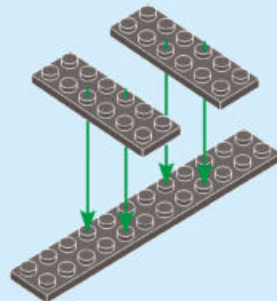
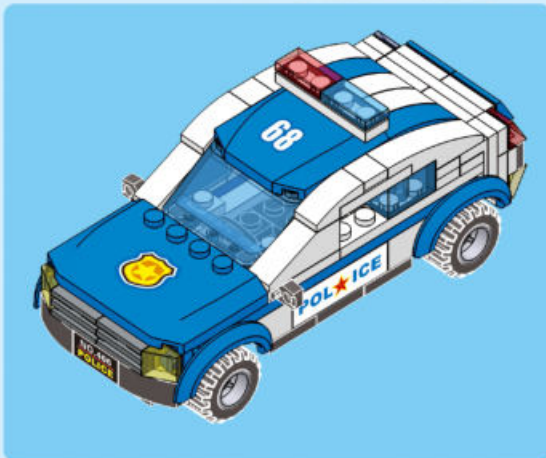

x2



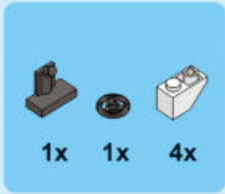

4.

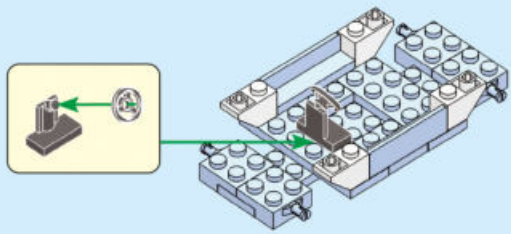

5.

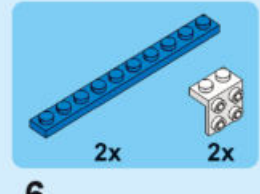
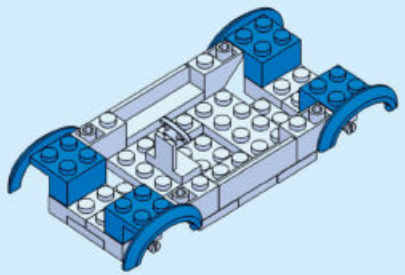

6.

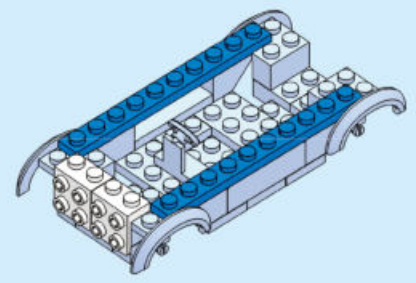

7.

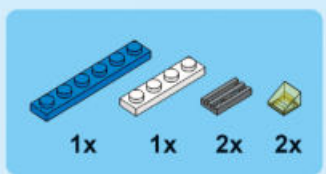
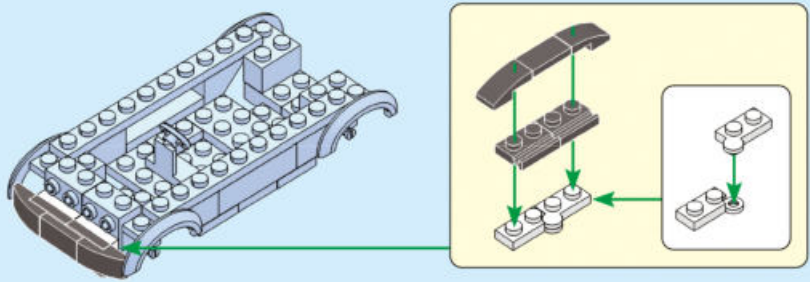

8.

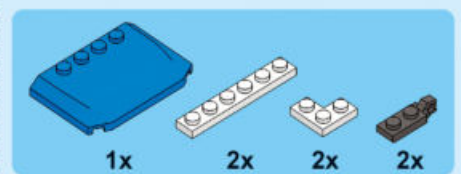
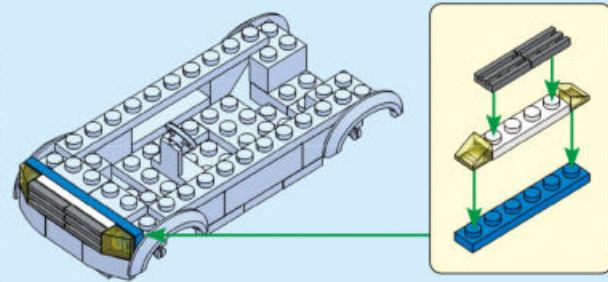

9.

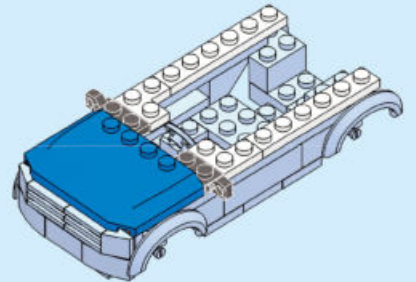



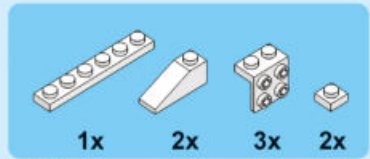

10.

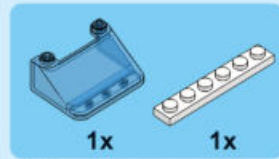
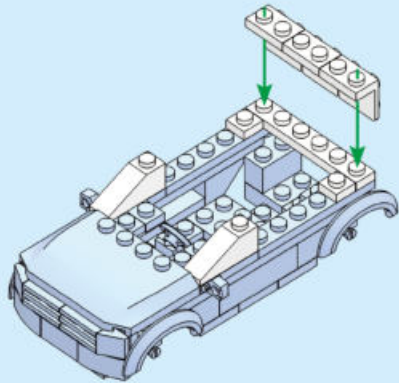

11.

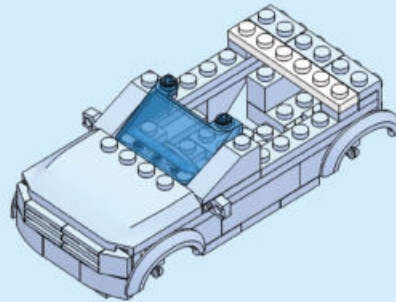

12.

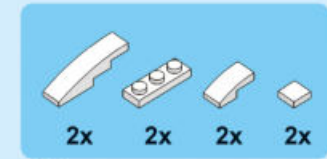
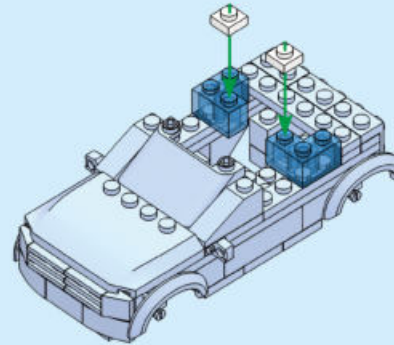

13.

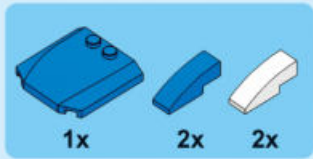
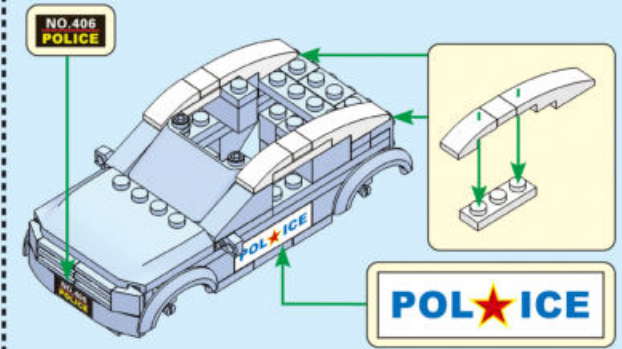

14.

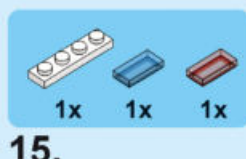
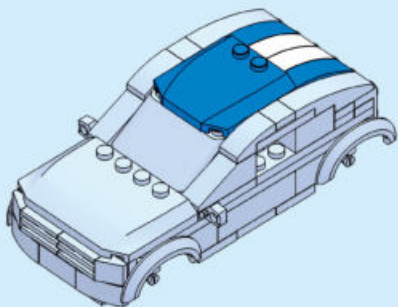

15.

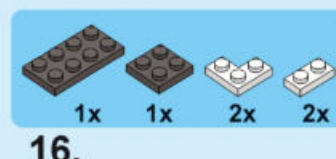
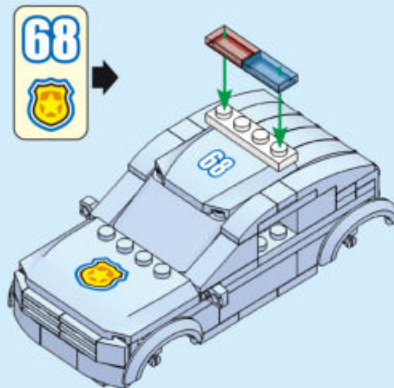

16.

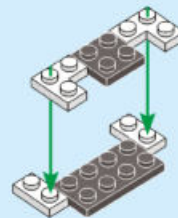

17.

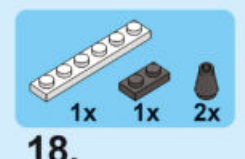
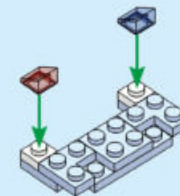

18.

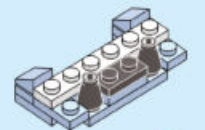





19.

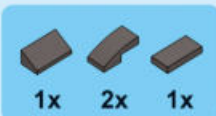
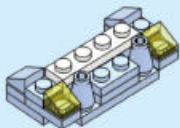

20.

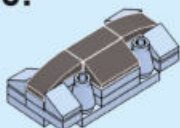

21.

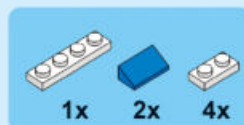
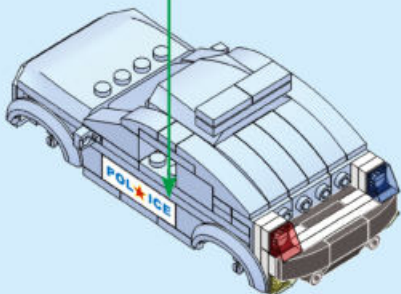

22.

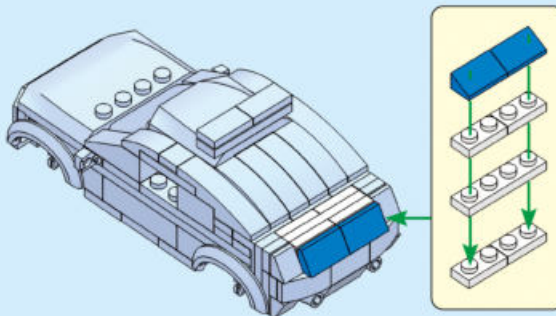

23.

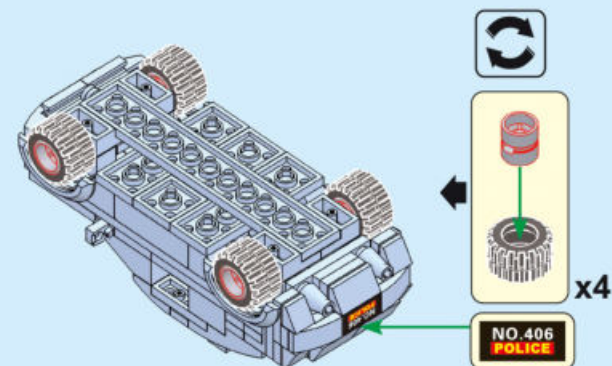

8

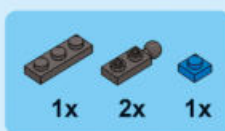

1.

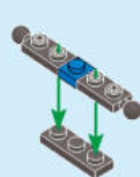

3.

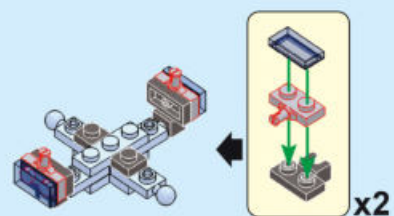

4.

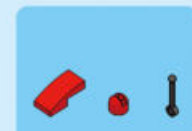
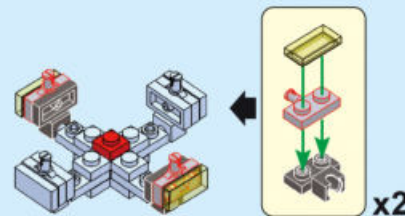

5.

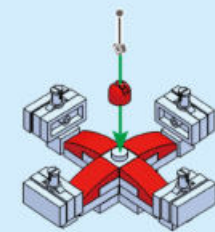





6.

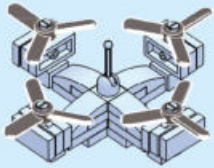

7.

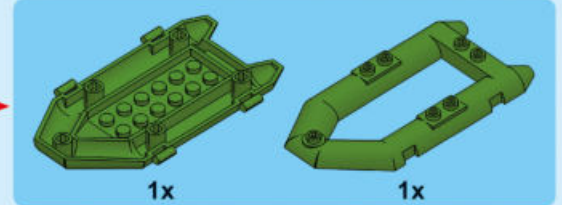
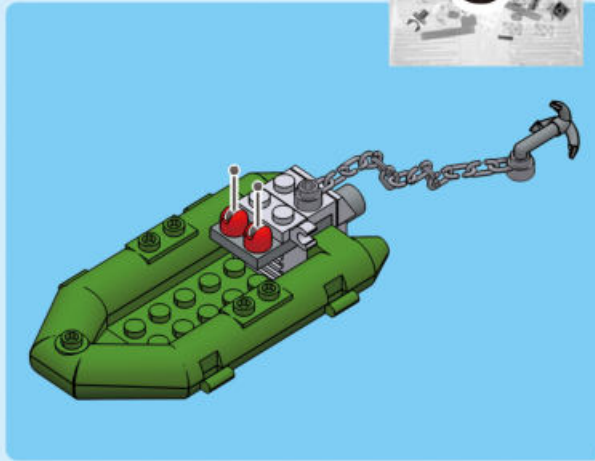
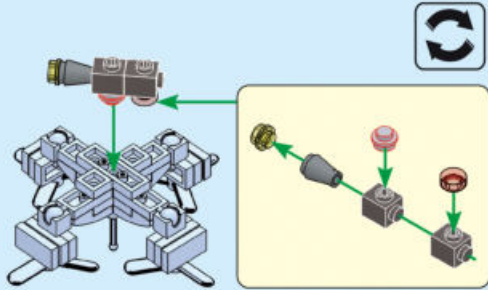

1.

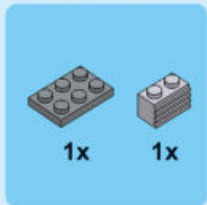
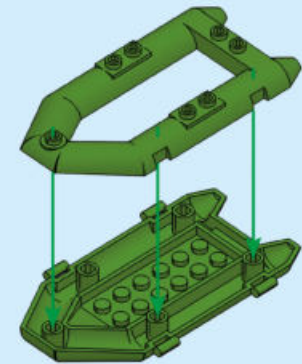

2.

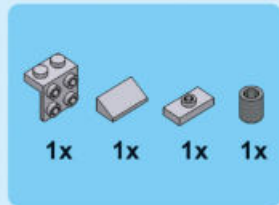
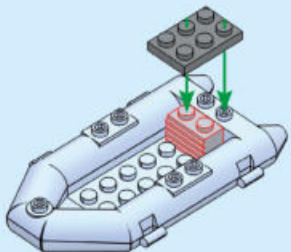

3.

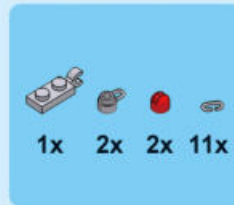
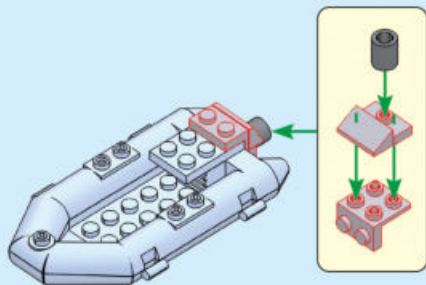

4.

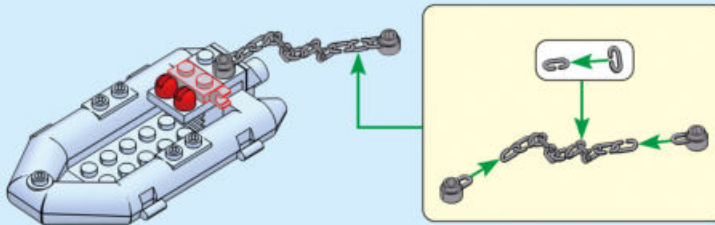

5.

