

1.

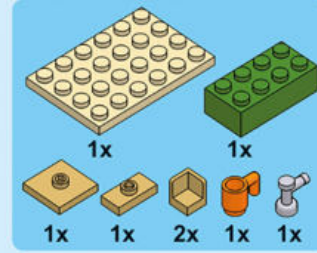

2.

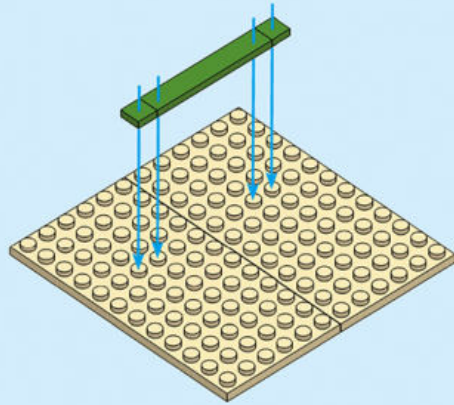
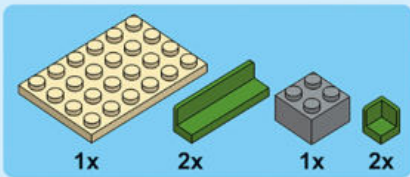
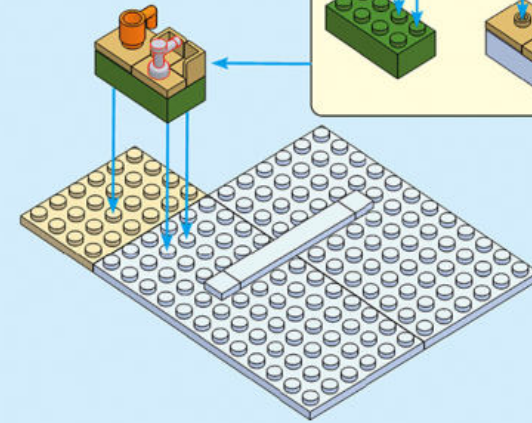
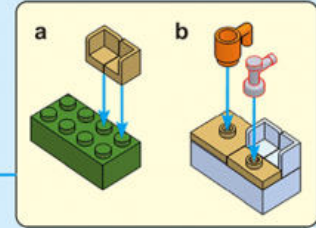

3.

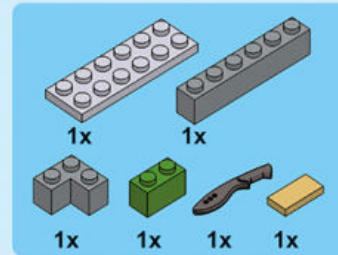
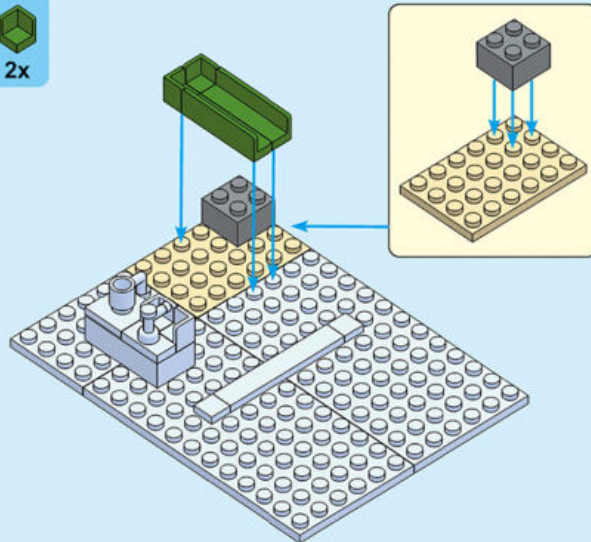

4.

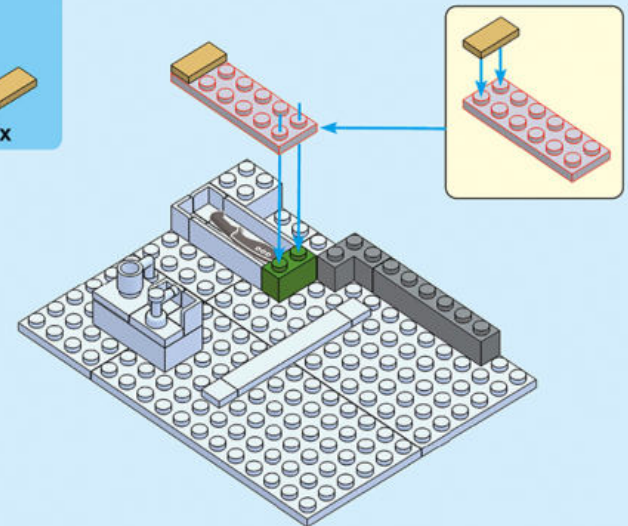

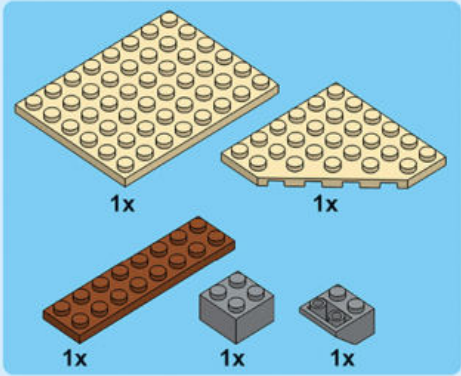

5.

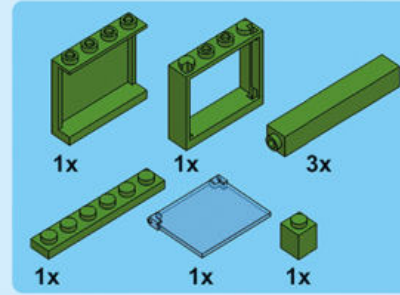
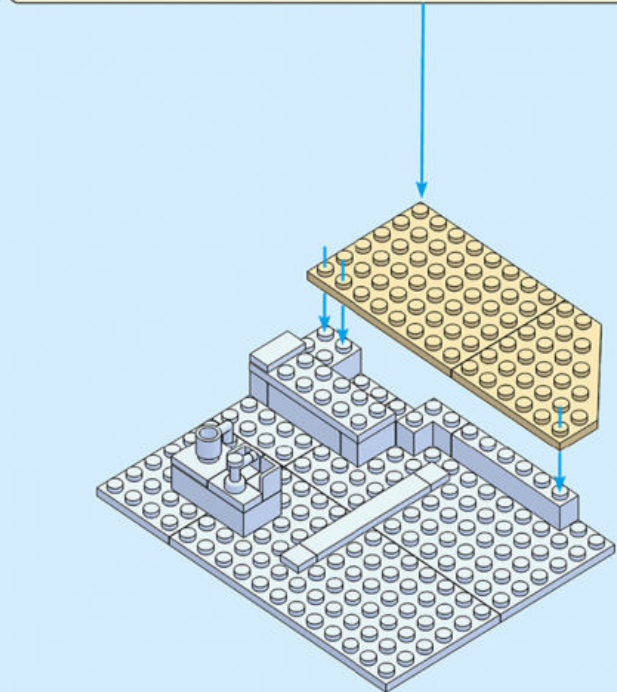
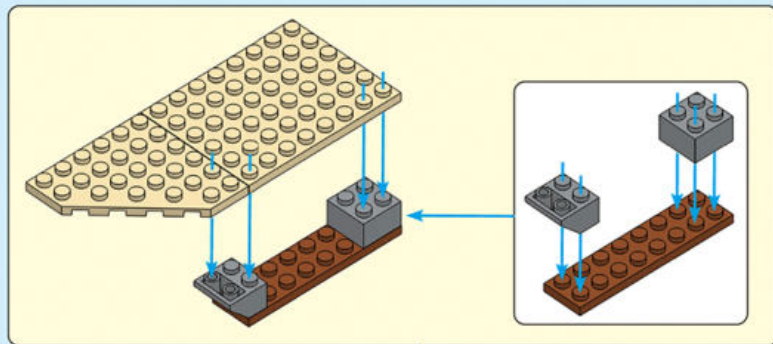

6.

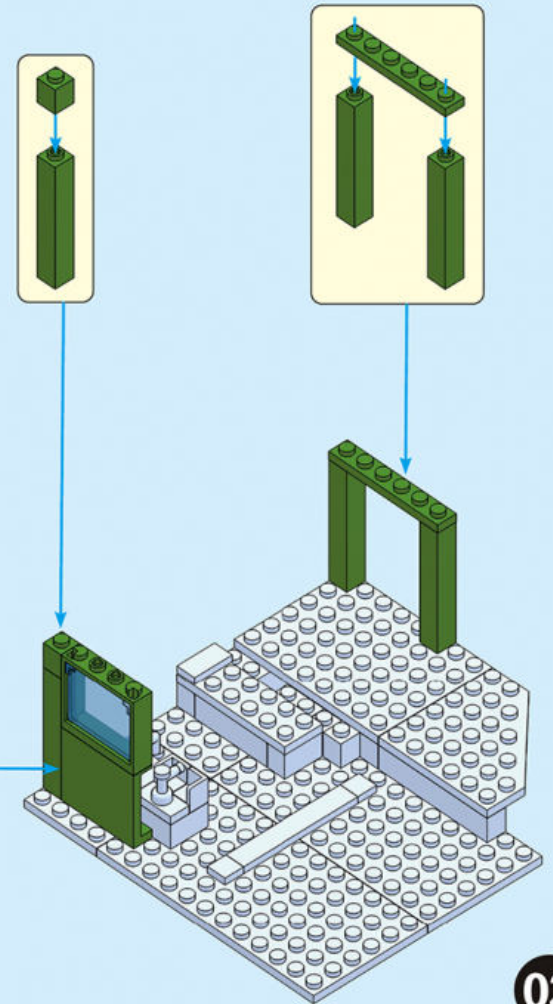



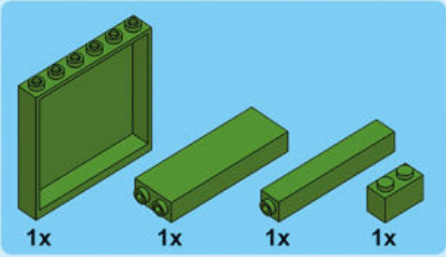

7.

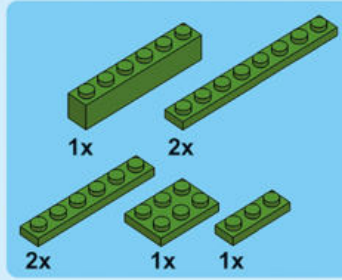
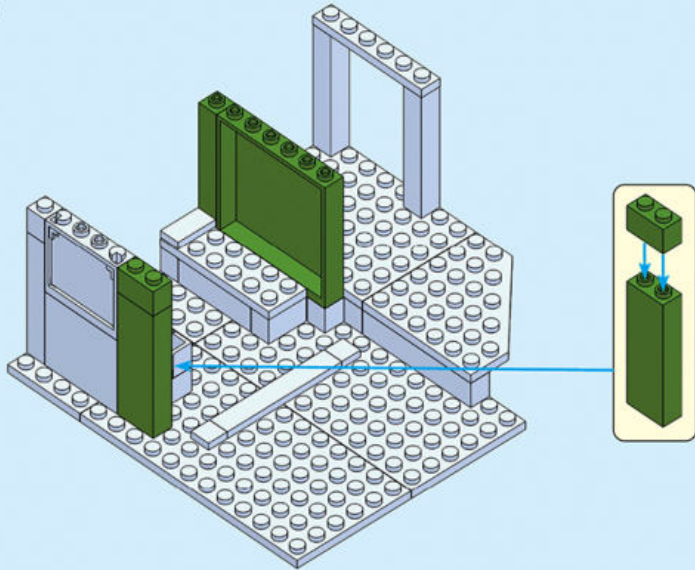

8.

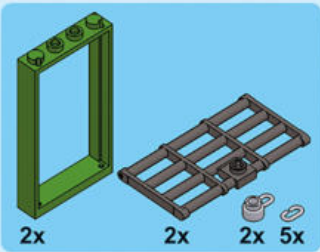
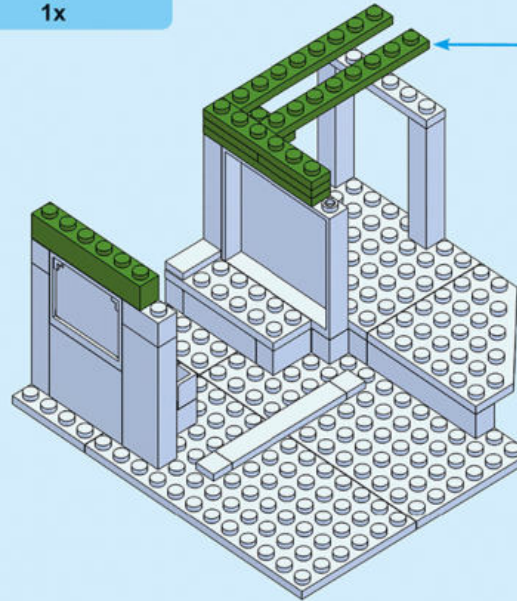

9.

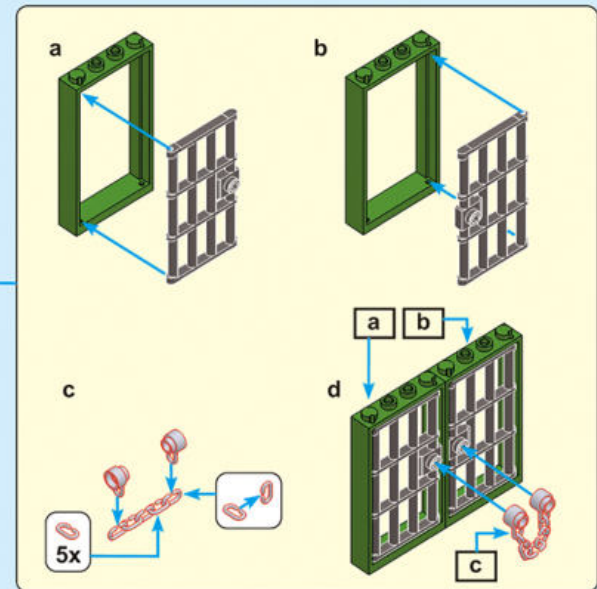
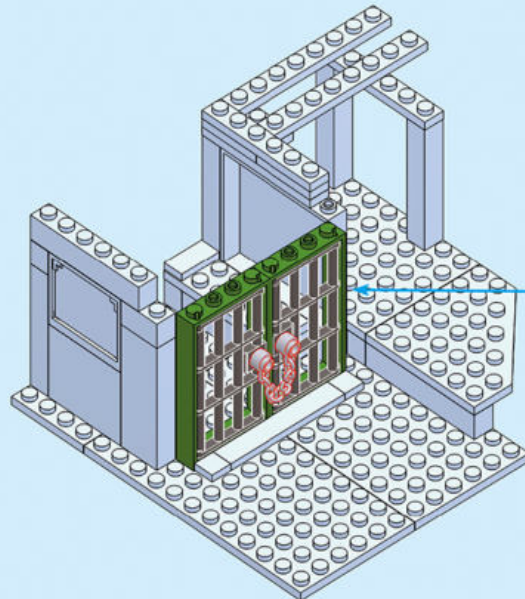

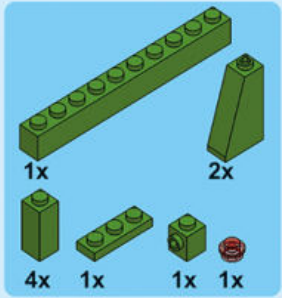

10.

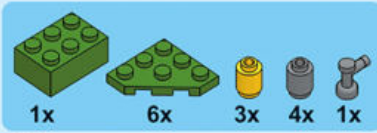
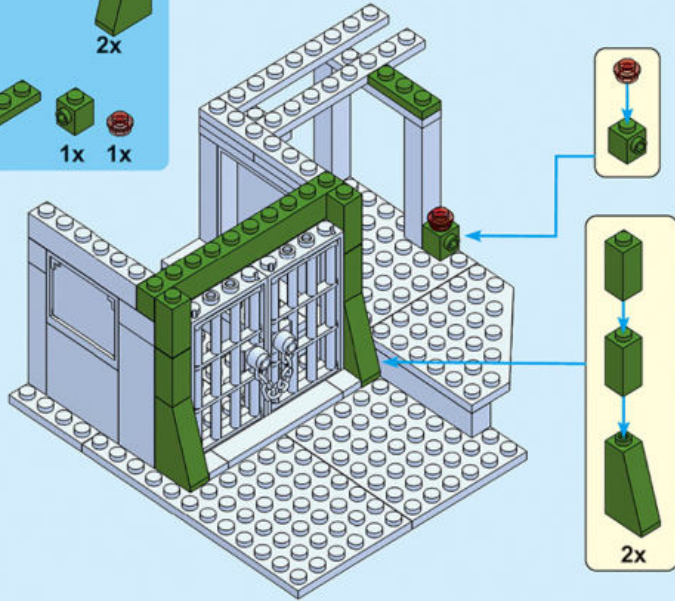

11.

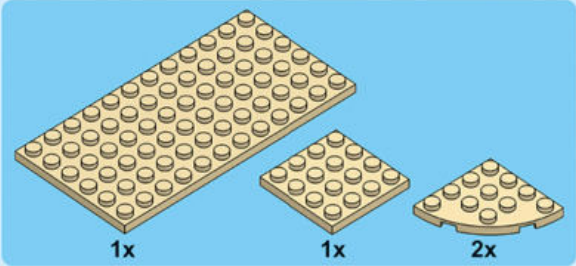
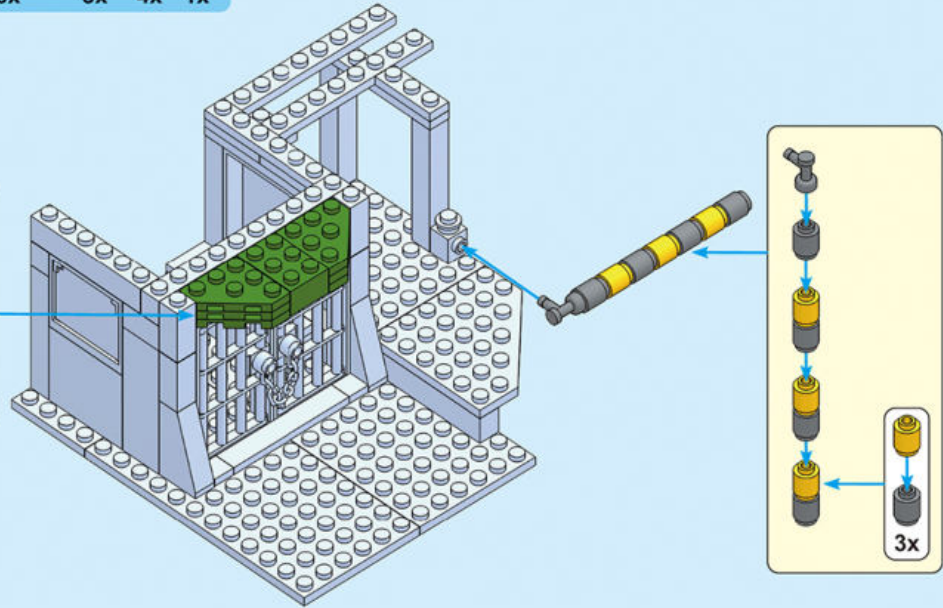
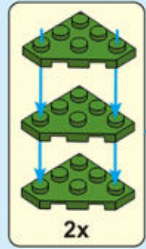

12.

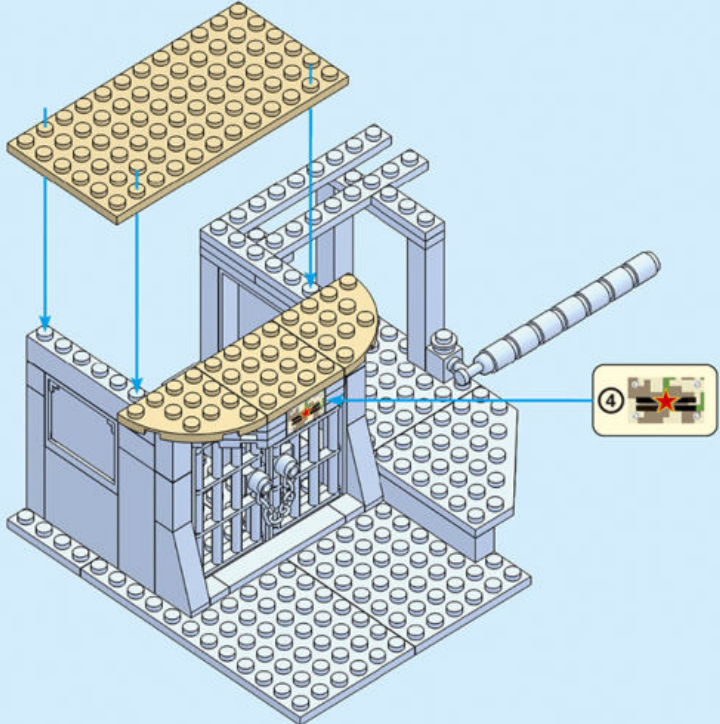



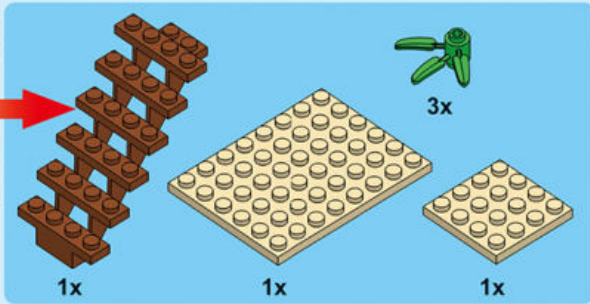

13.

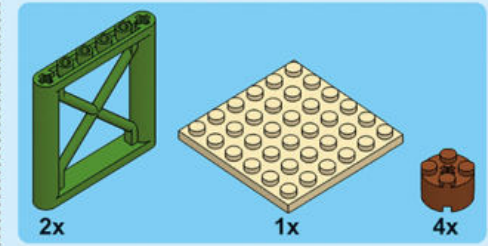
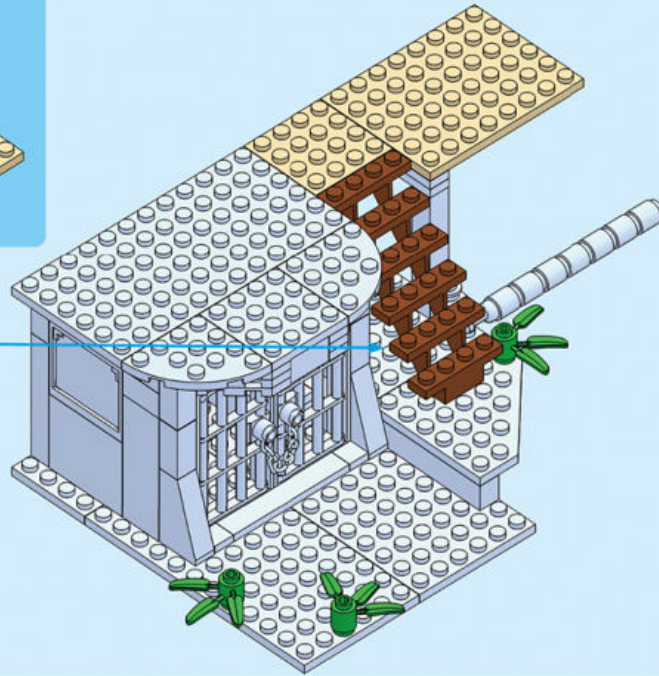
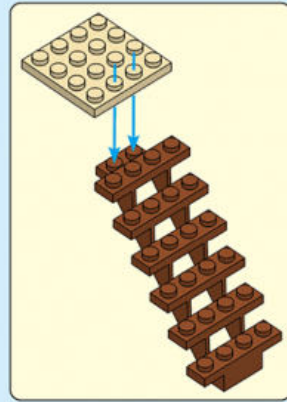

14.

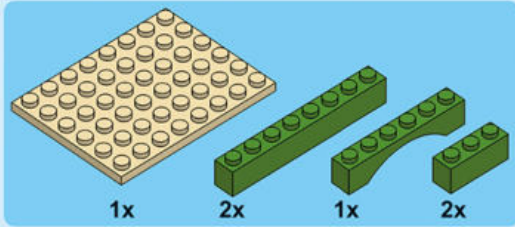
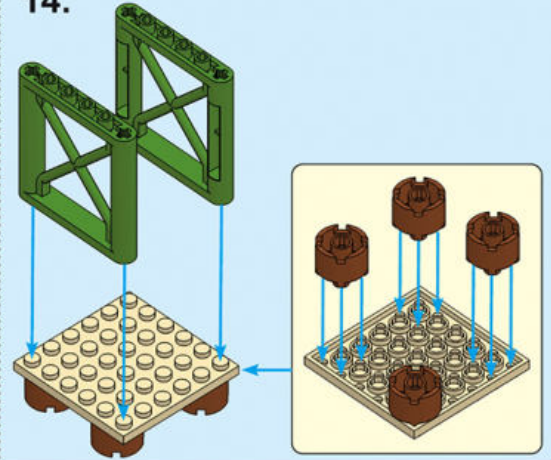

15.

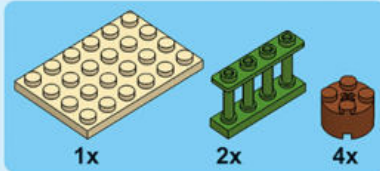
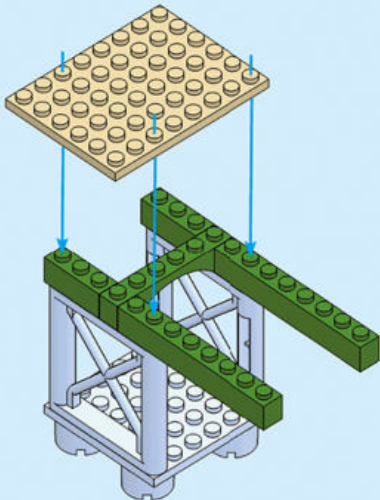

16.

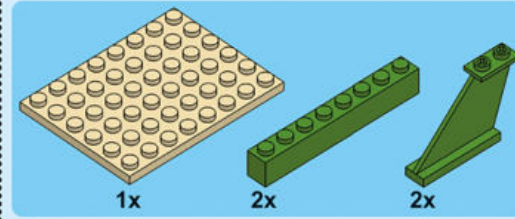
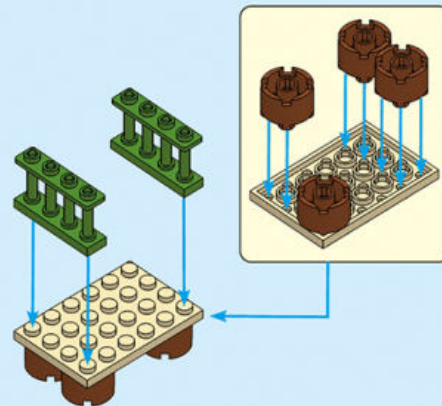

17.

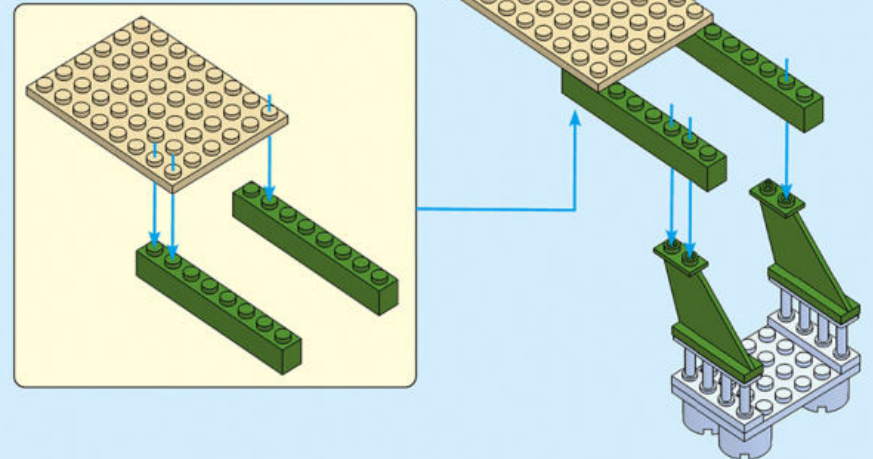



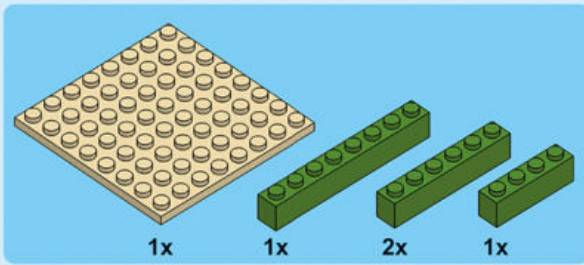

18.

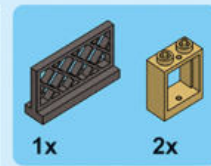
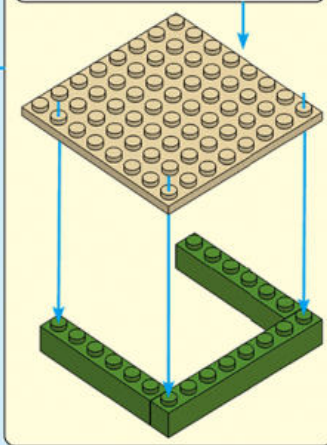
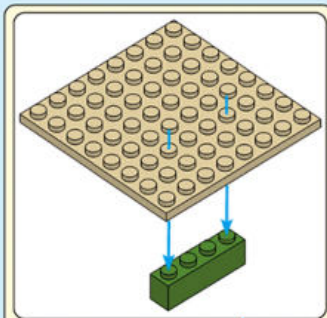
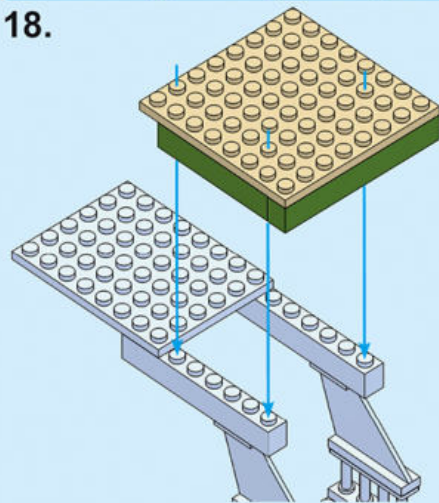

20.

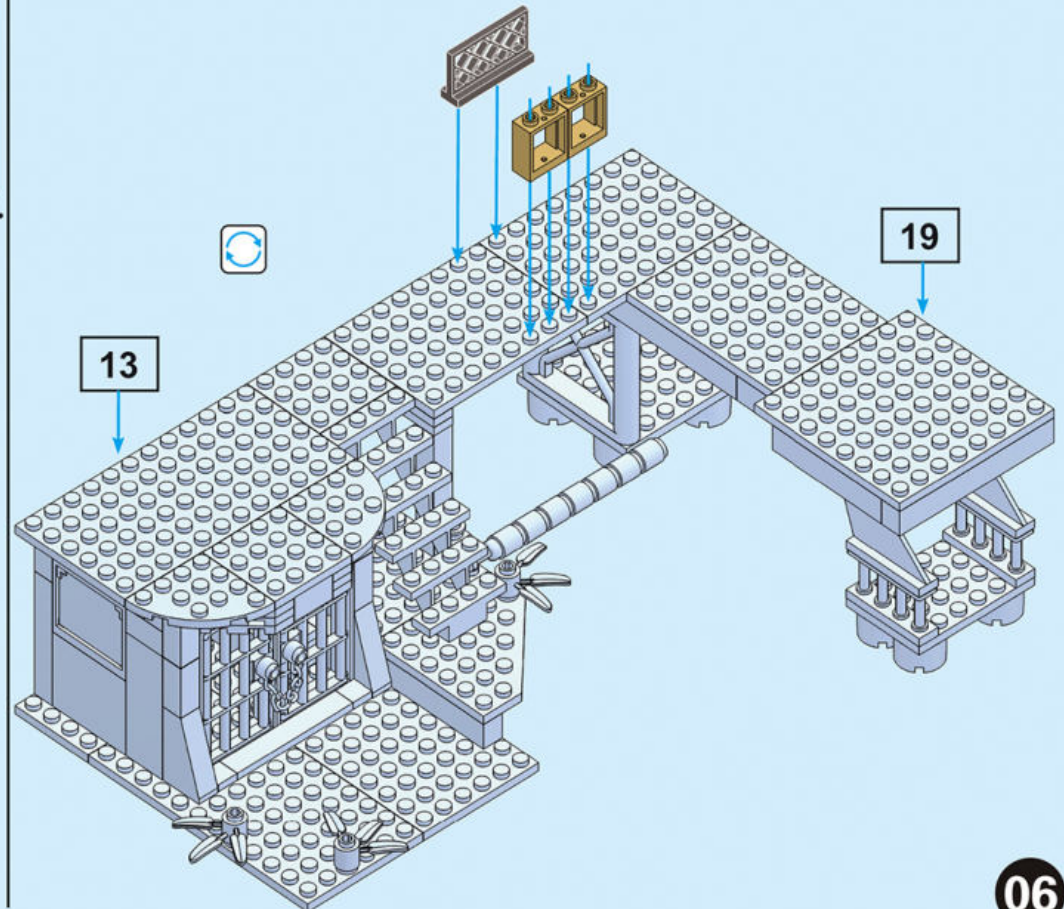

19.

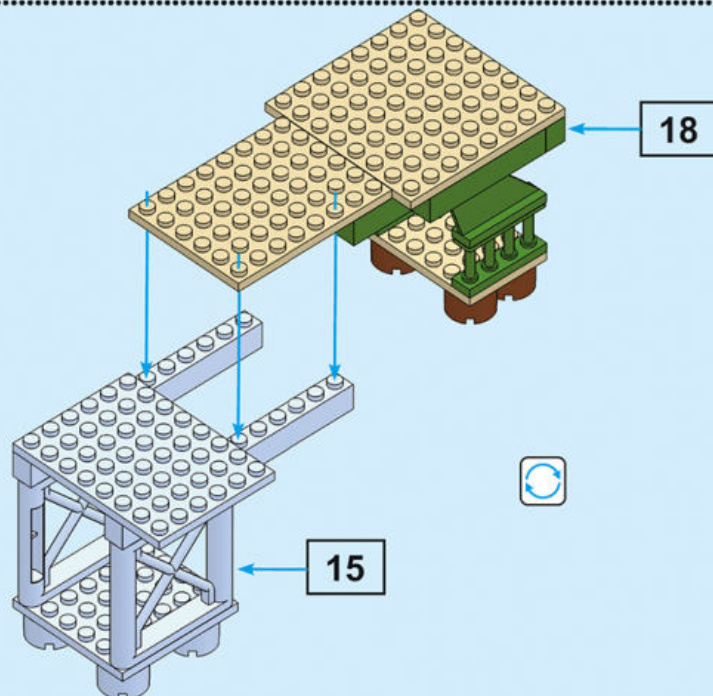



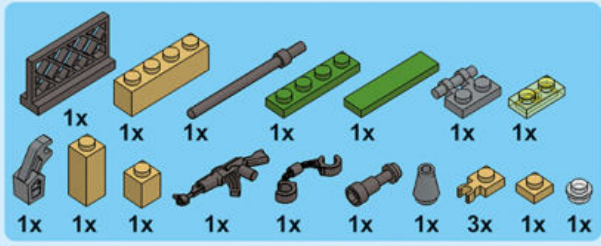

21.

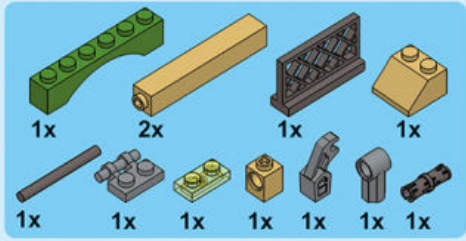
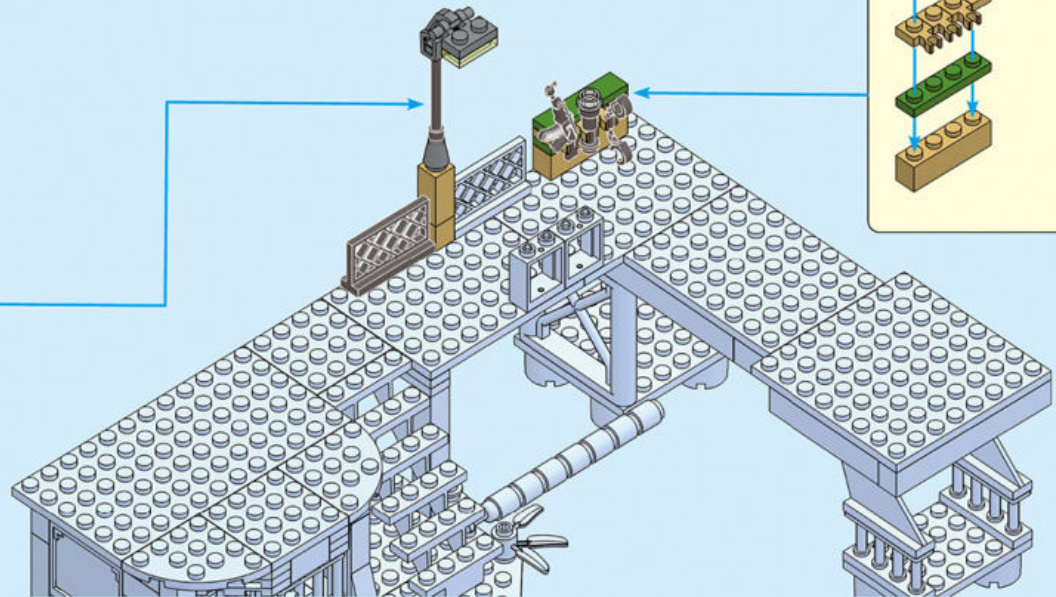
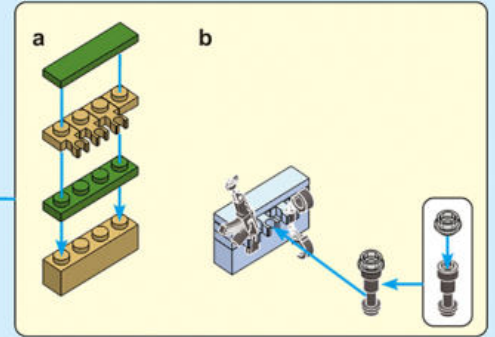
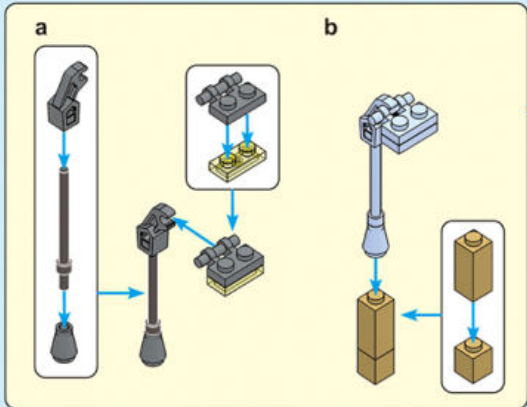

22.

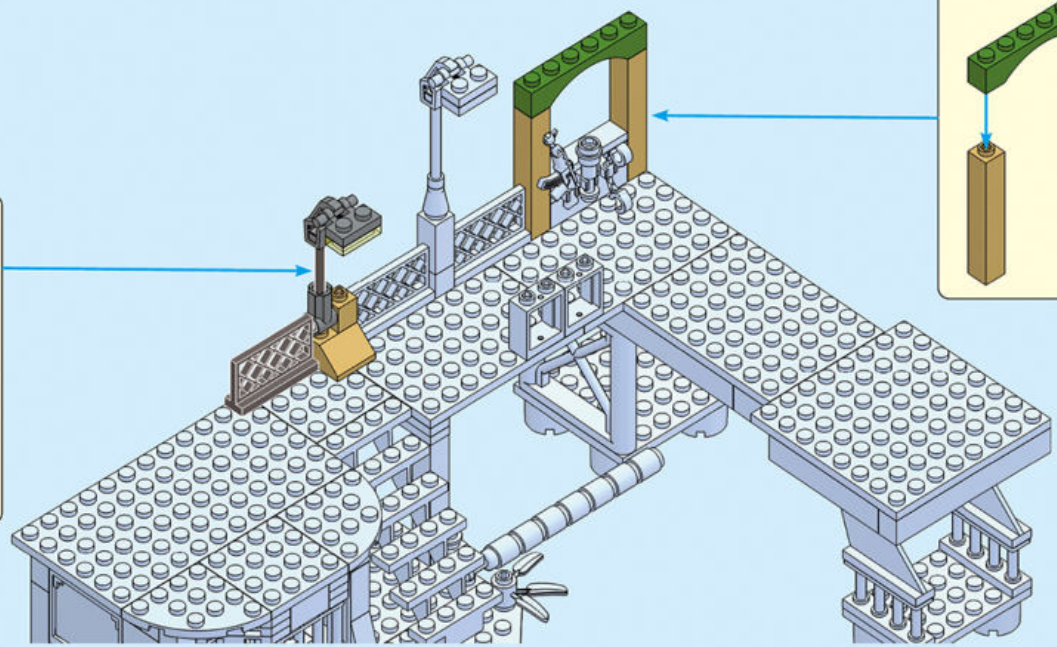
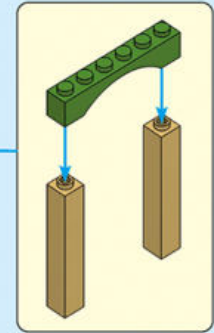
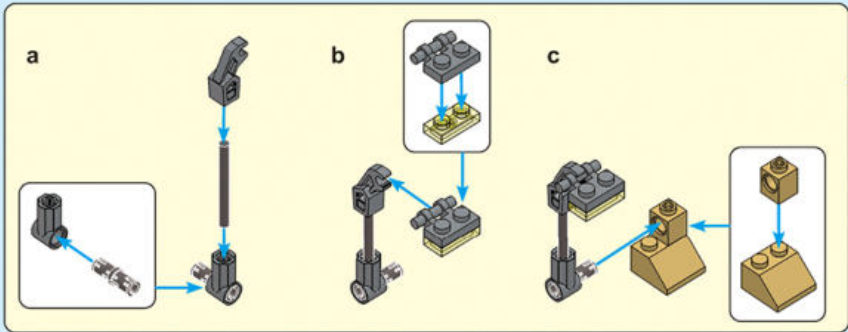







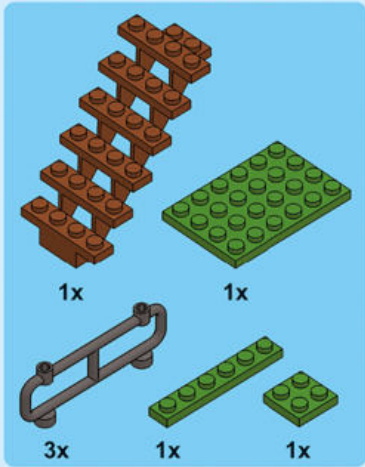

25.

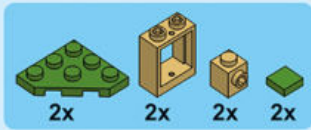
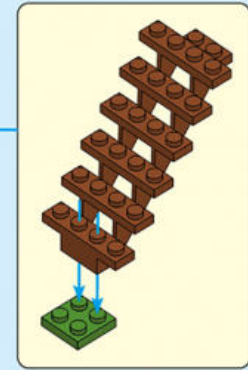
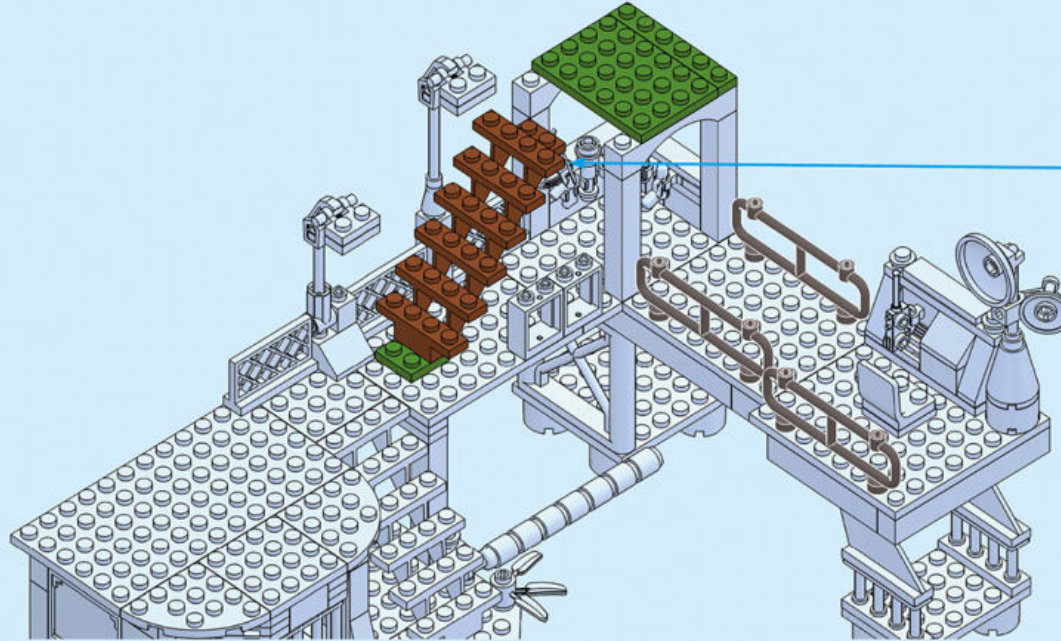

26.

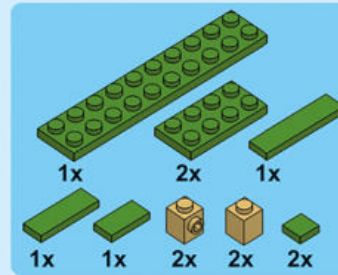
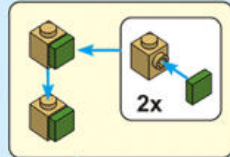
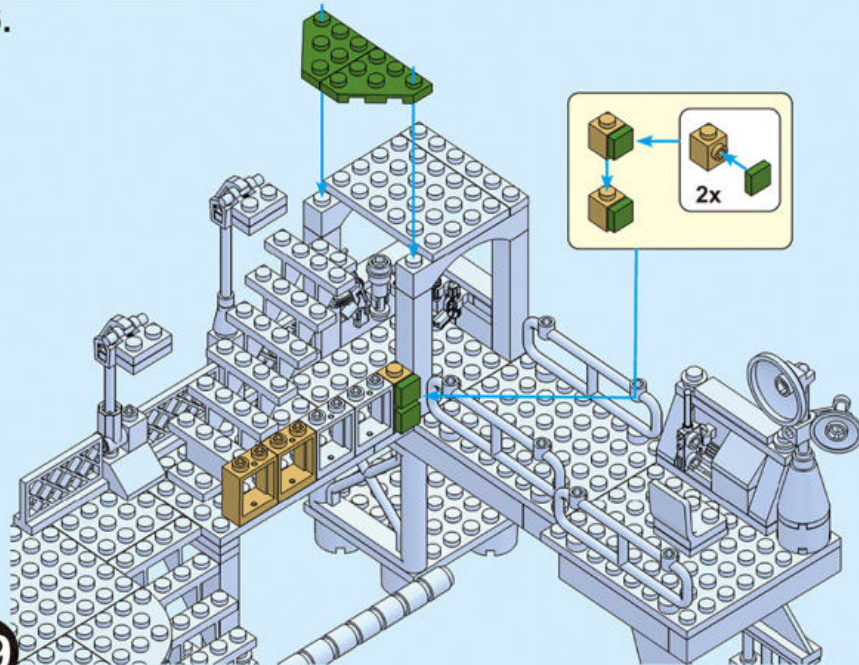

27.

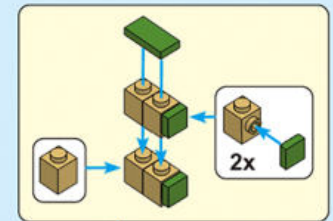
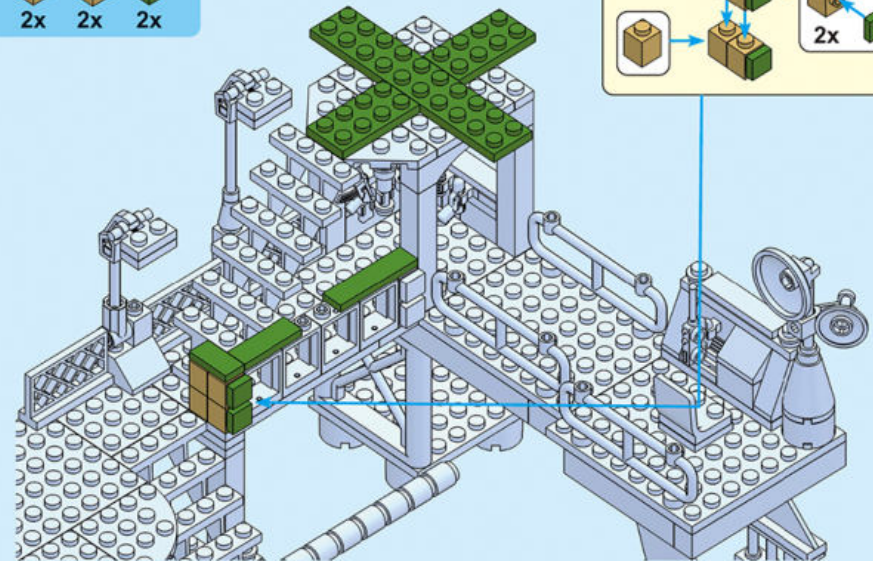



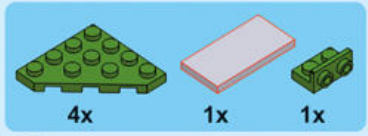

28.

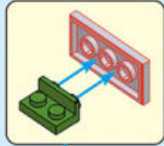
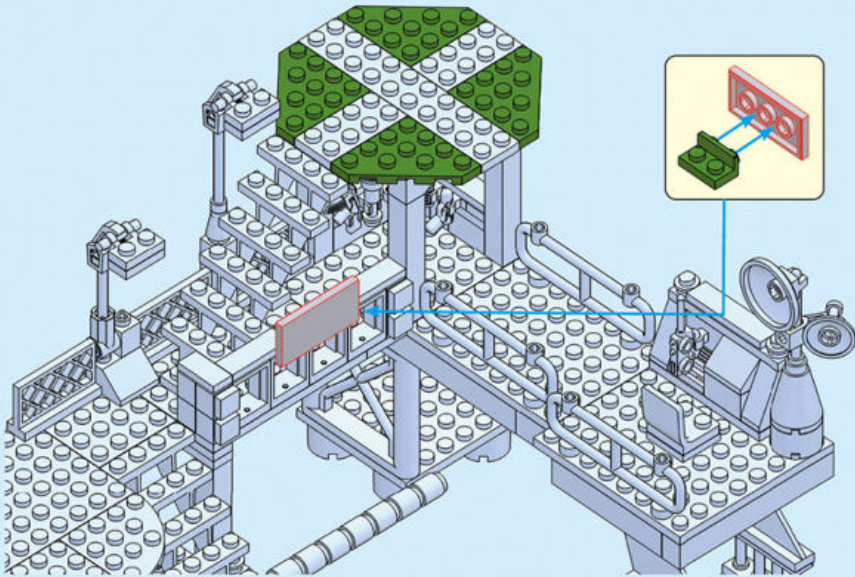

29.

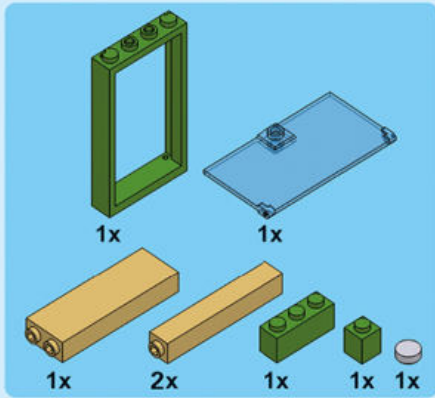
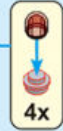
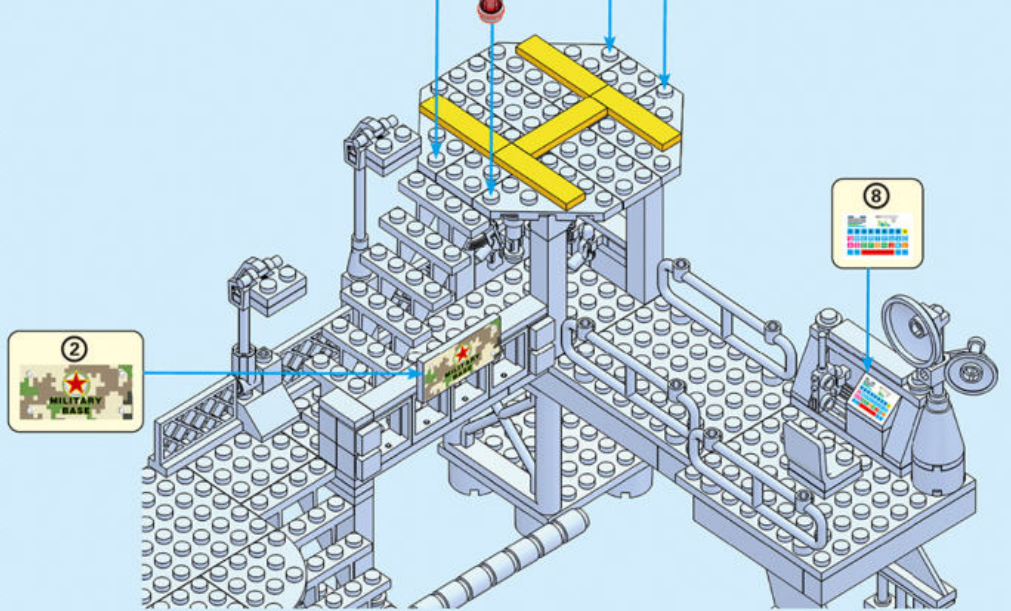

30.

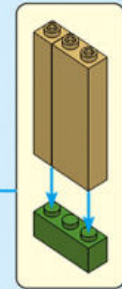
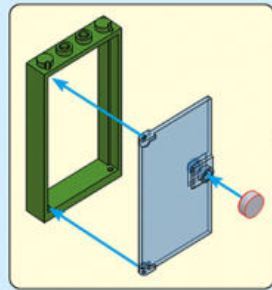
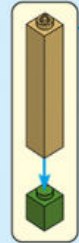
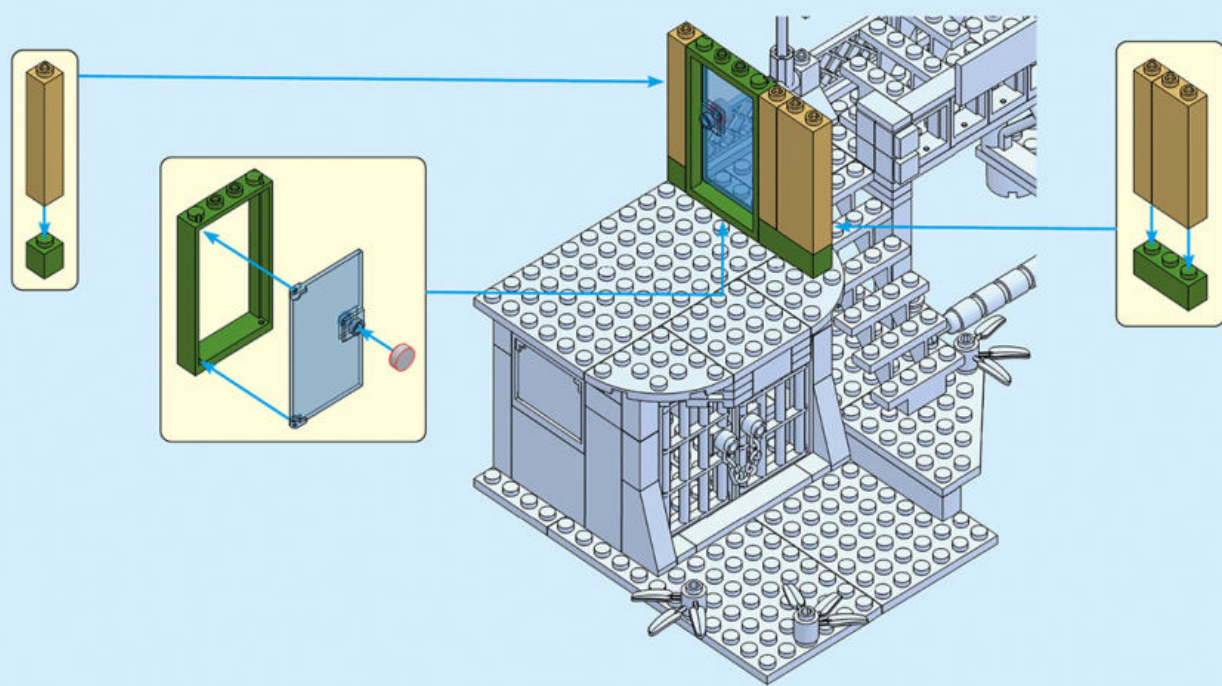



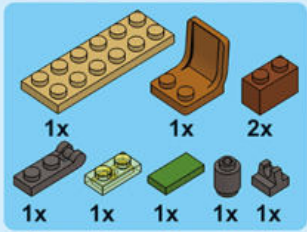

31.

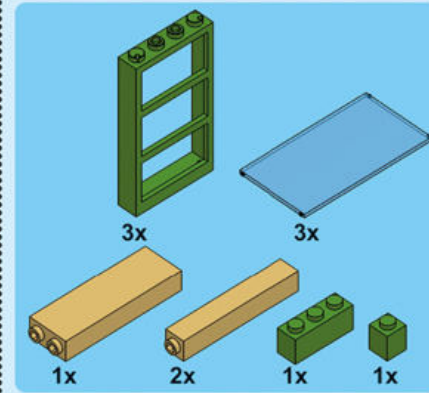
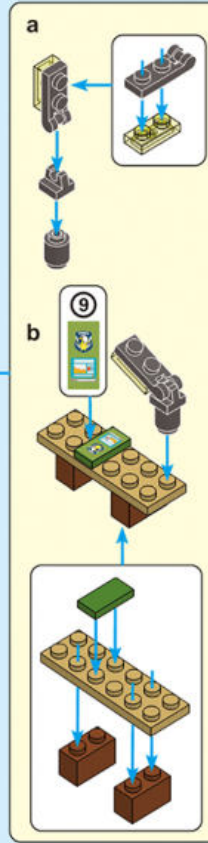
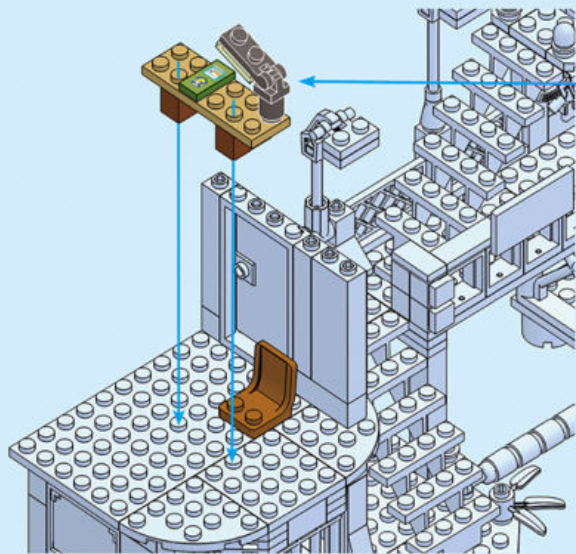

32.

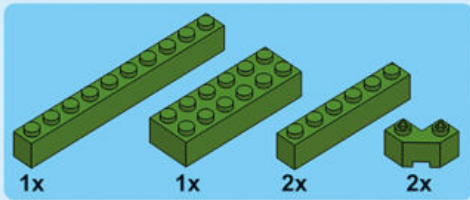
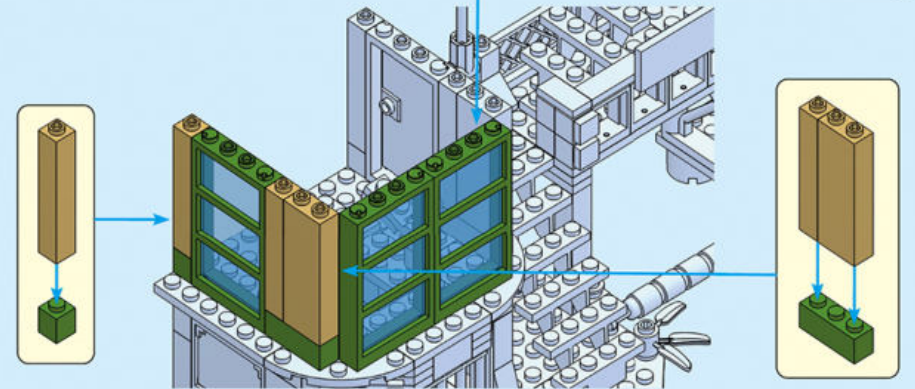

33.

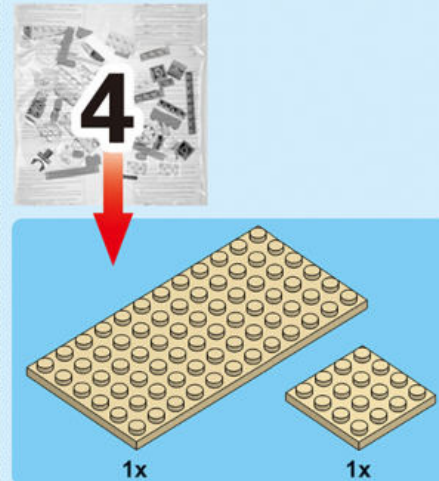
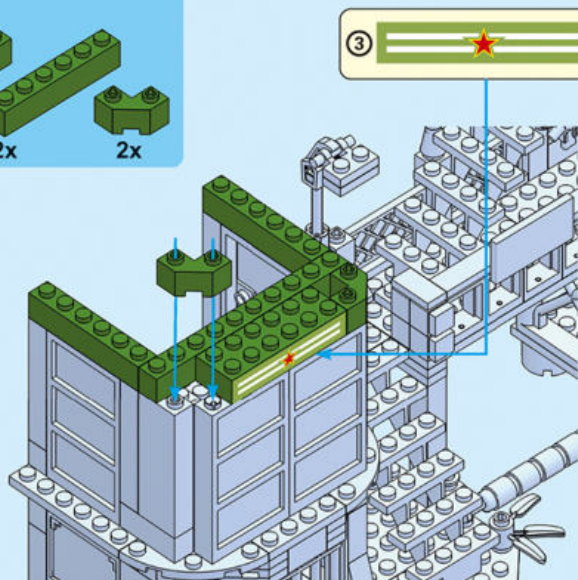

34.

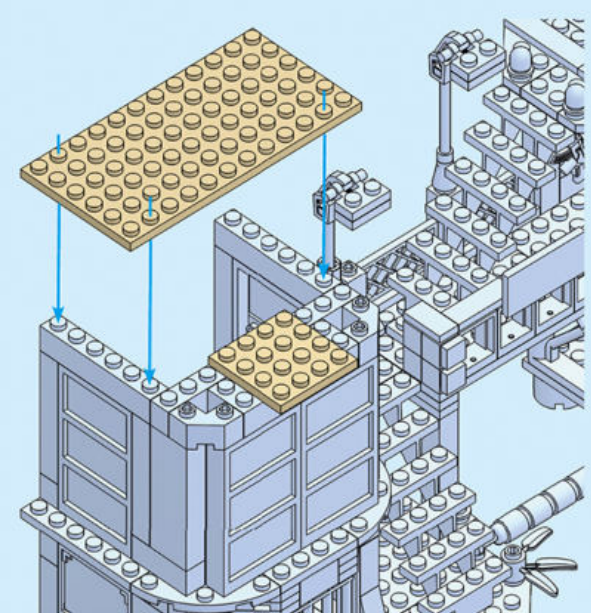



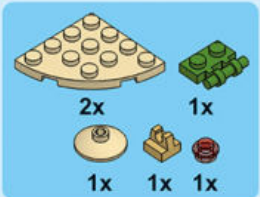

35.

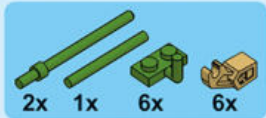
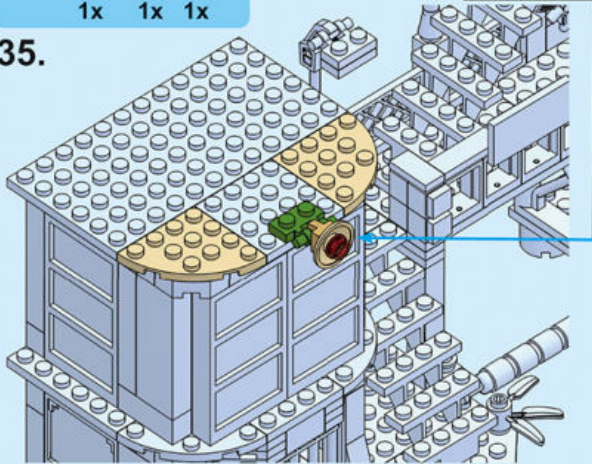

36.

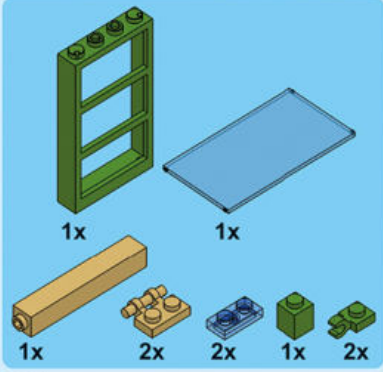
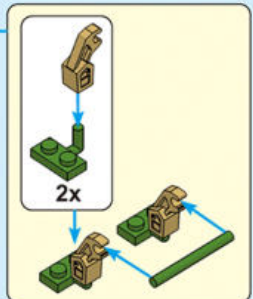
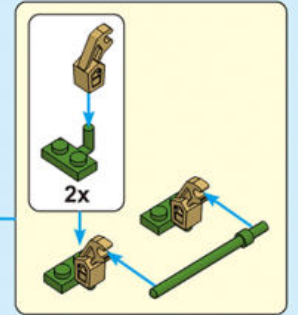
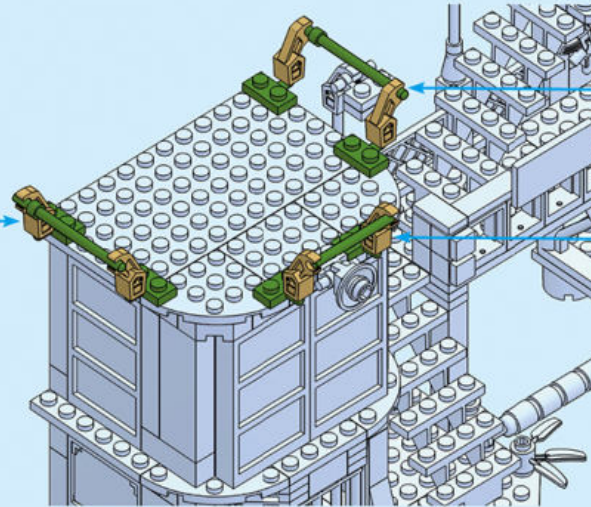
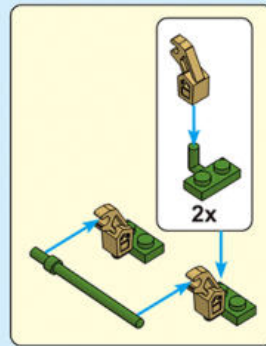

37.

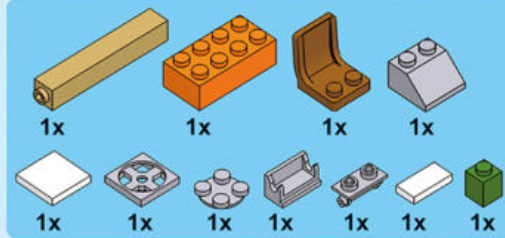
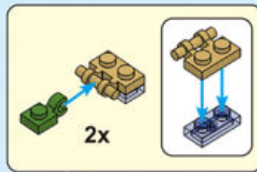

38.

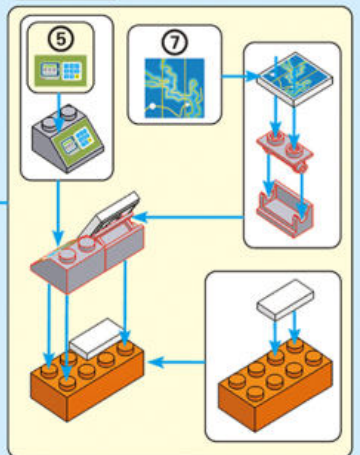
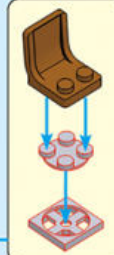
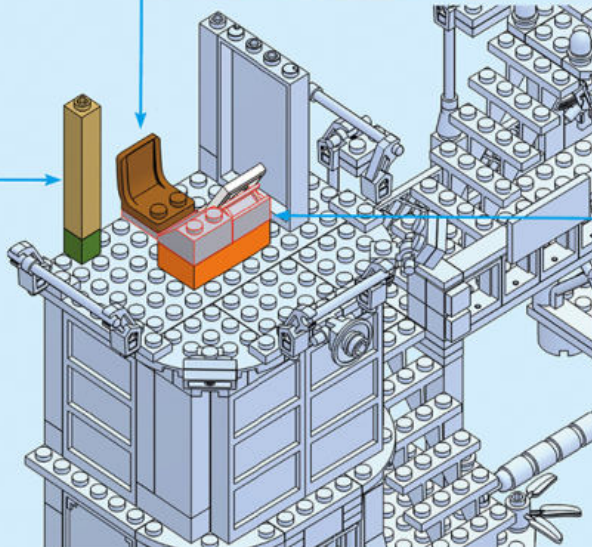
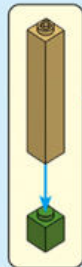



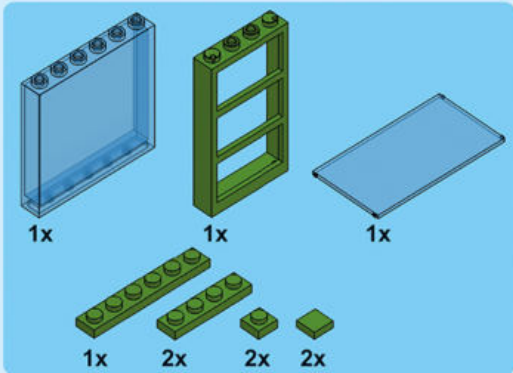

39.

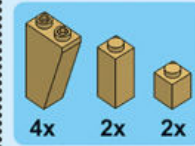
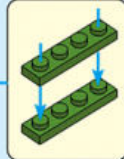
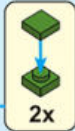
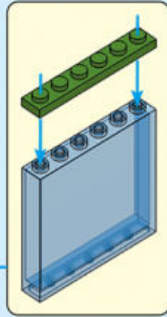
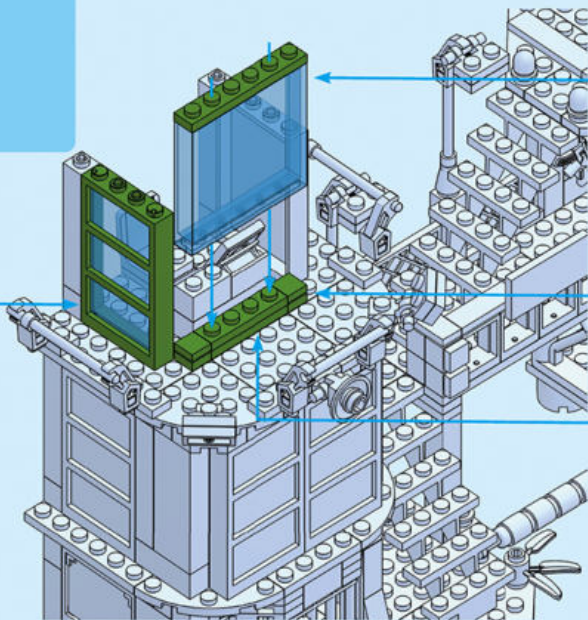
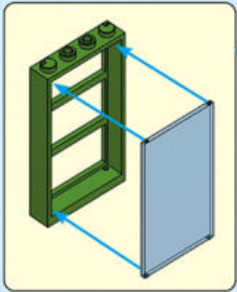

40.

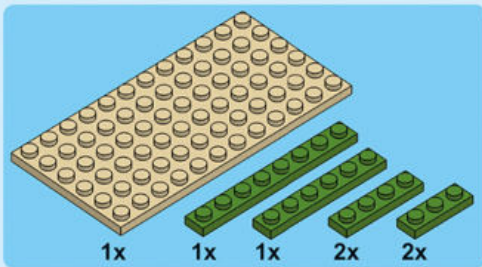
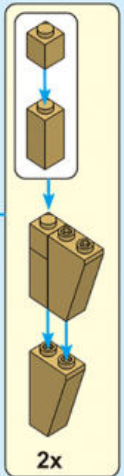
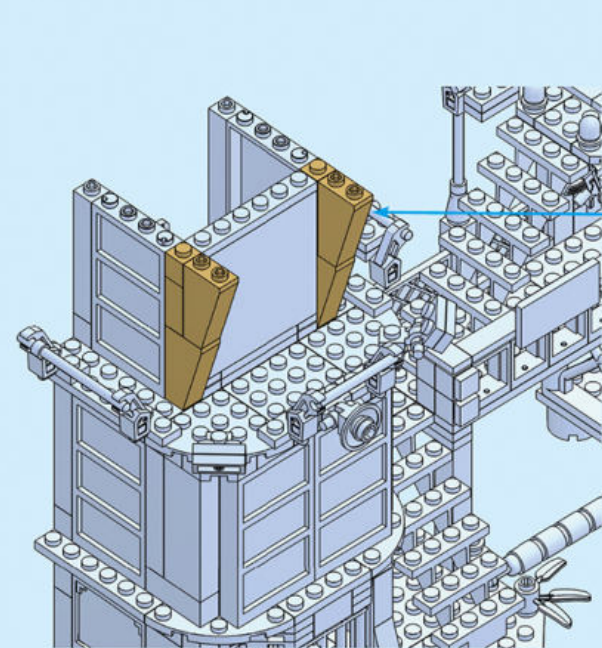

41.

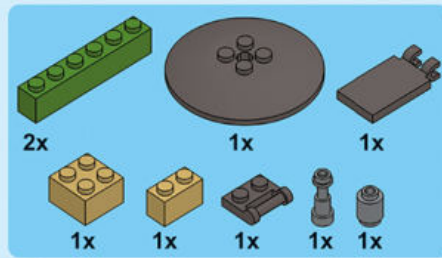
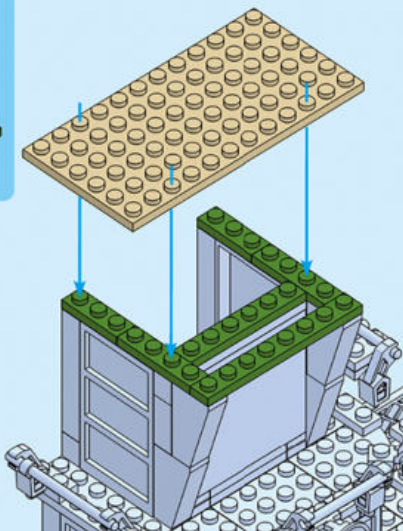

42.

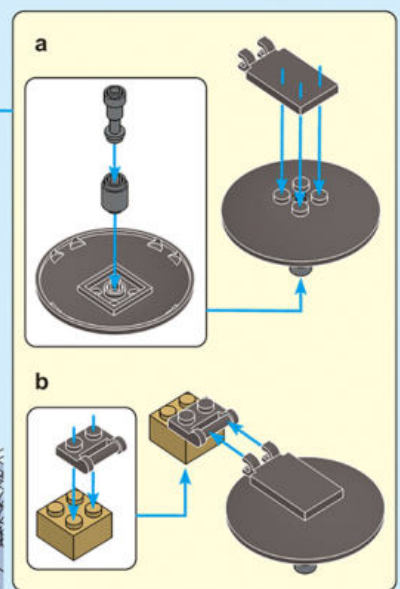
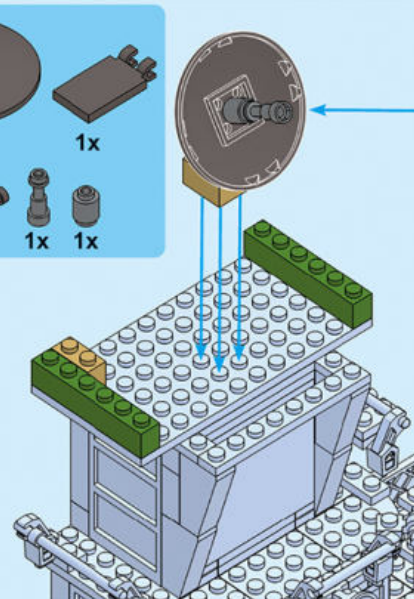



43.

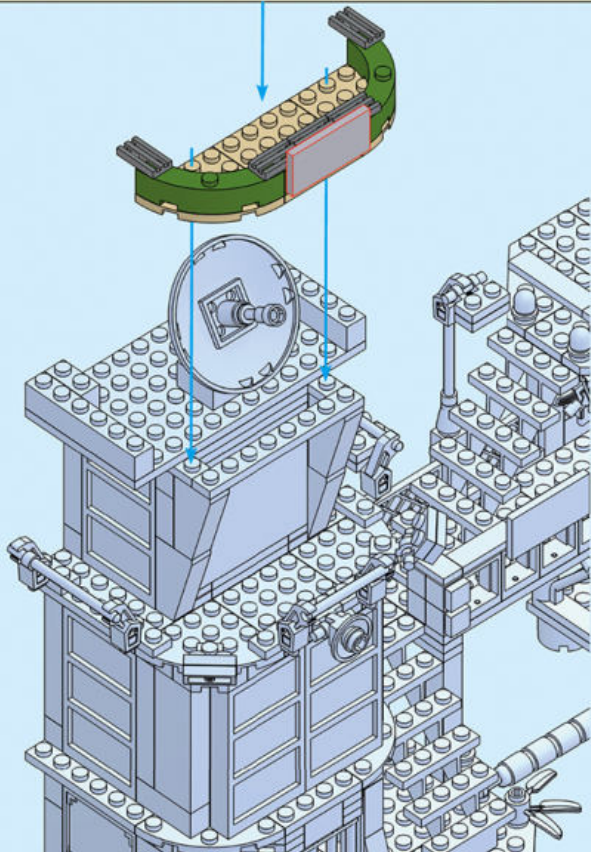
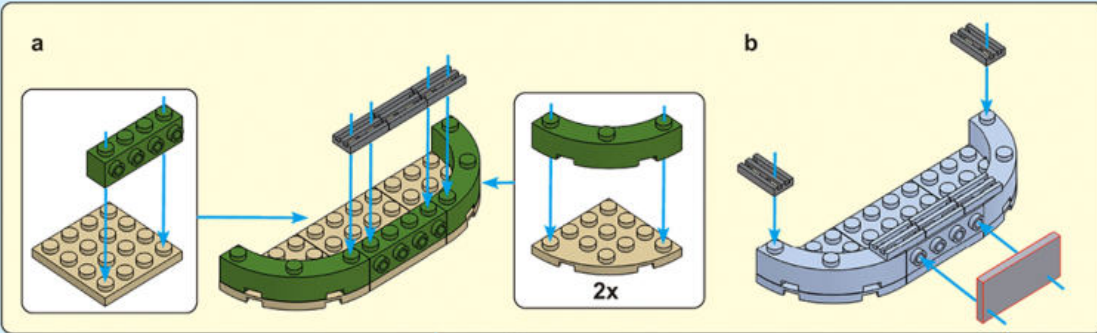
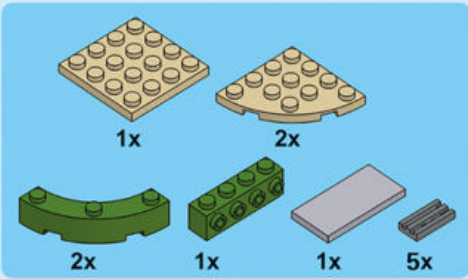

44.

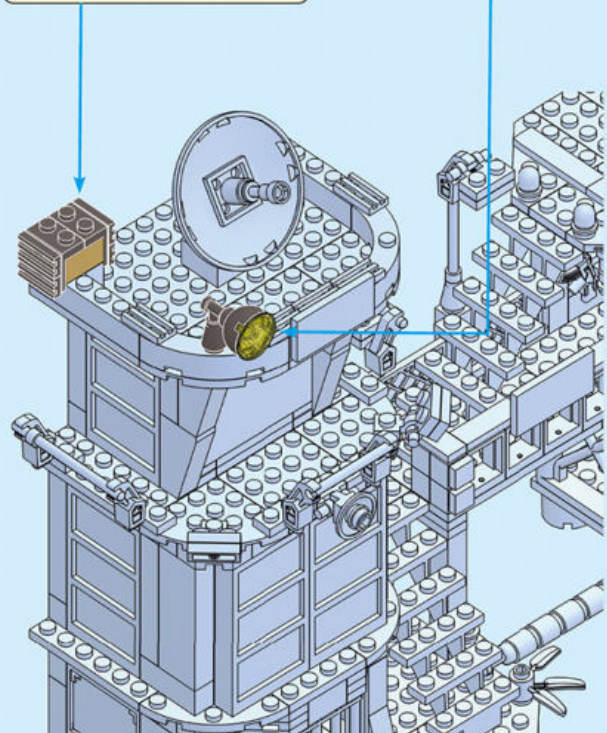
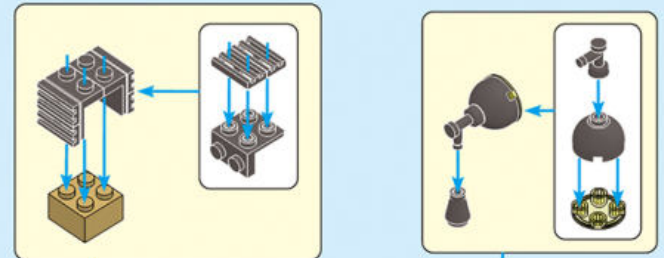





45.

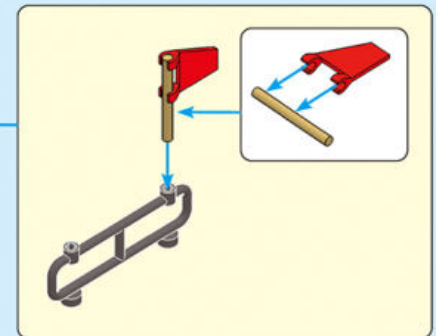
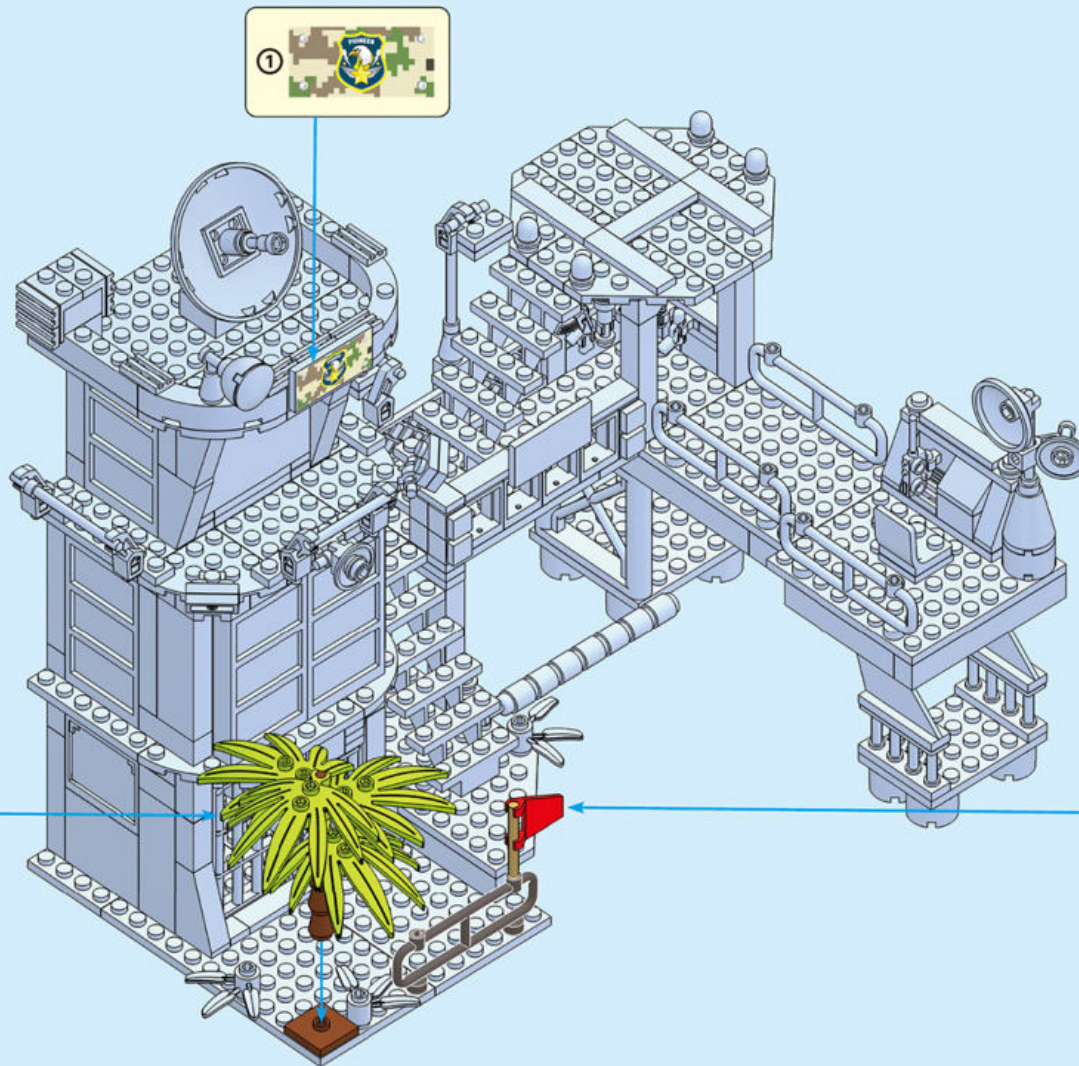
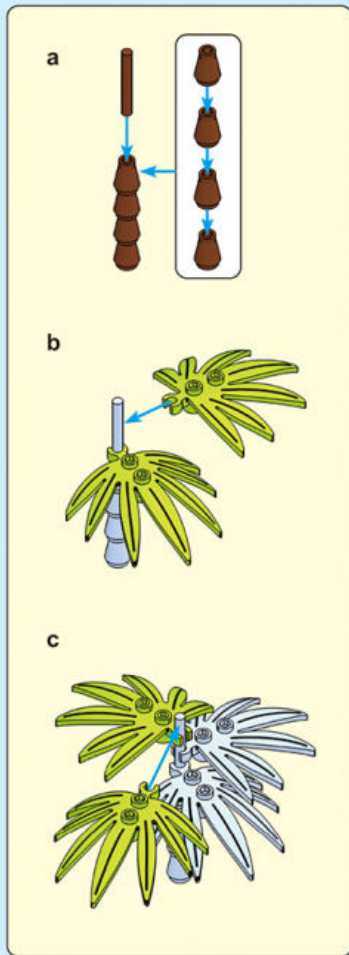



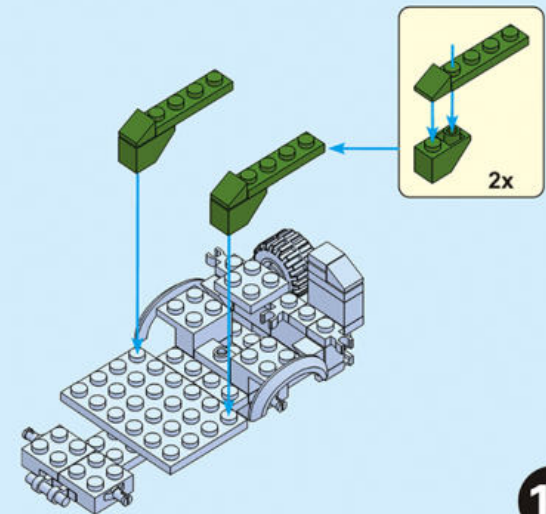
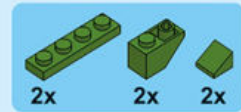
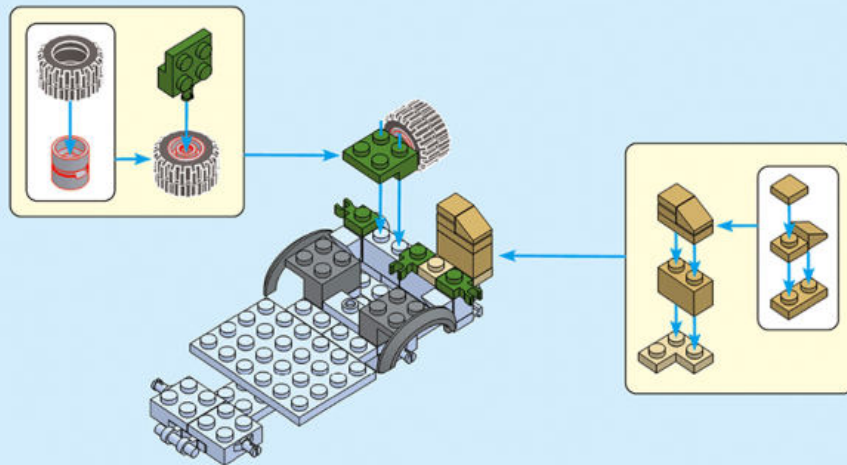
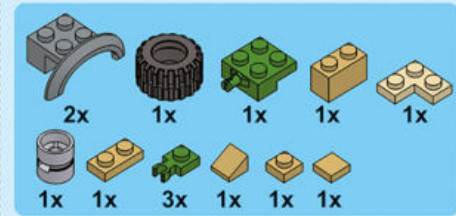
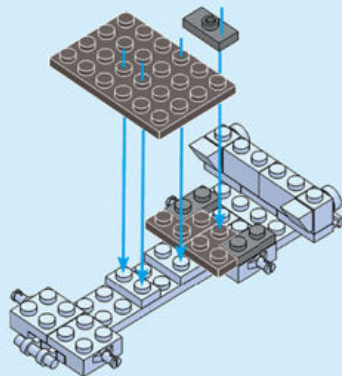
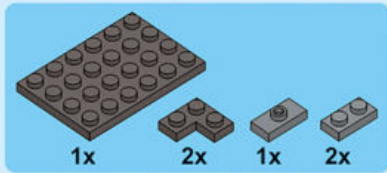
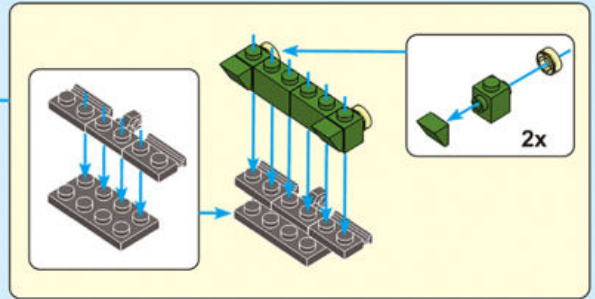
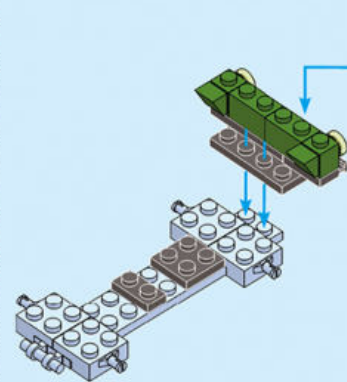
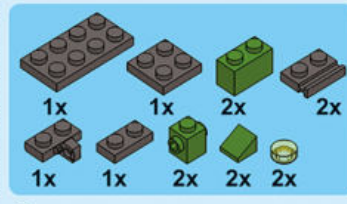
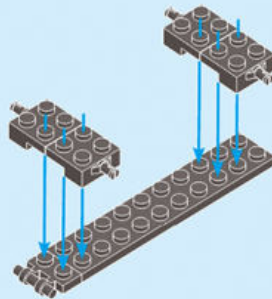
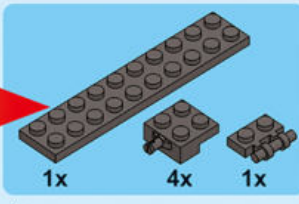
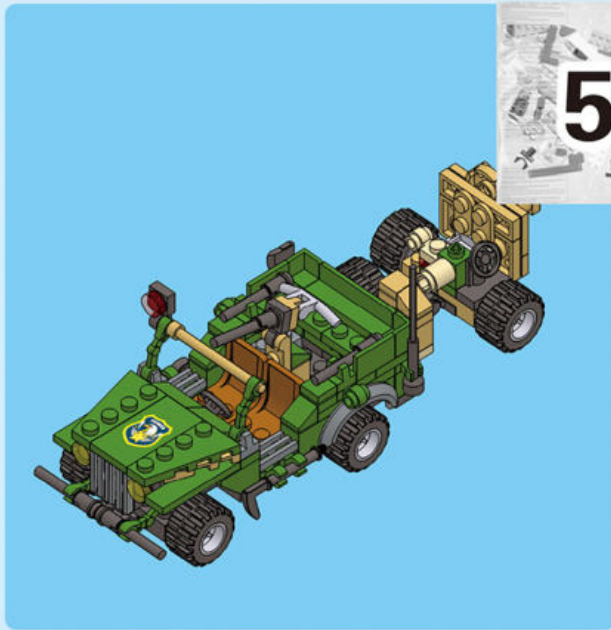



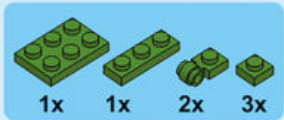

6.

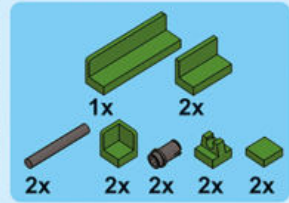
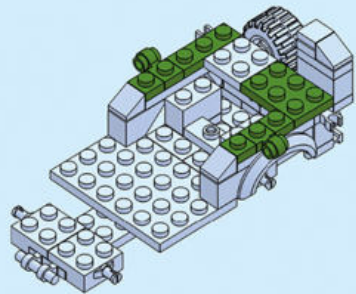

7.

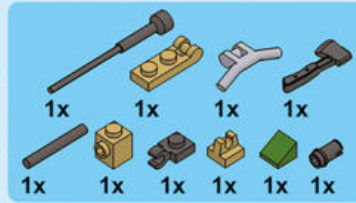
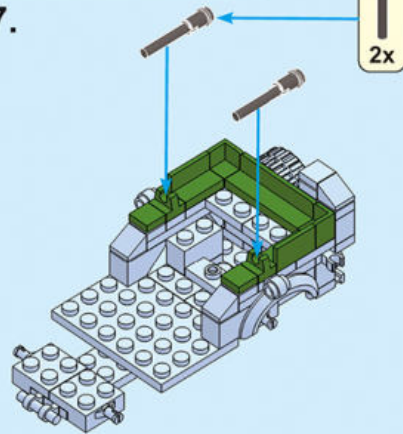

8.

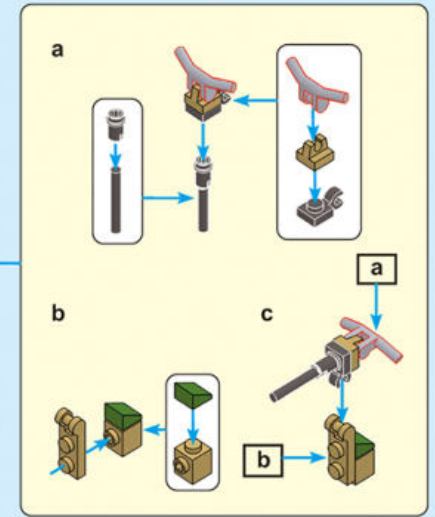
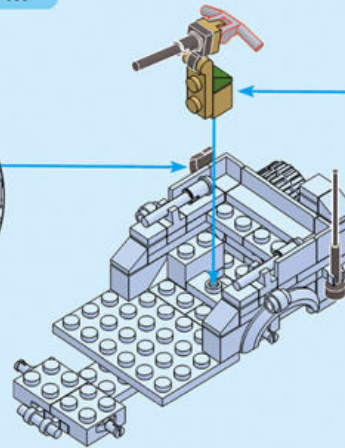
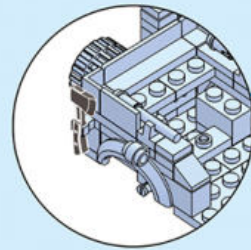

9.

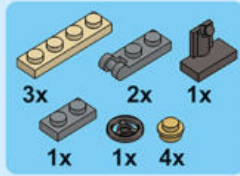
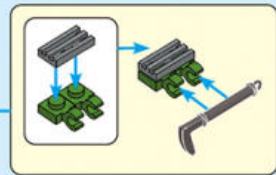
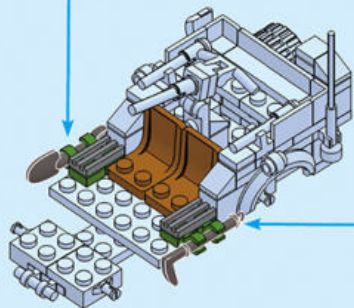
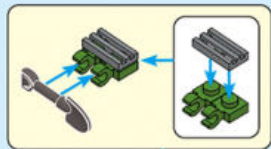

10.

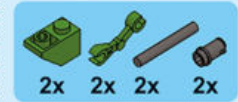
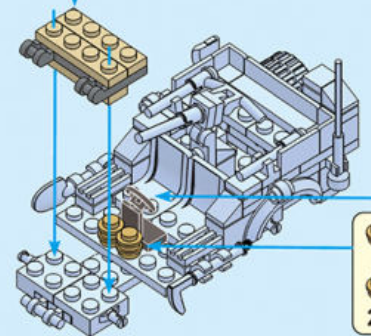
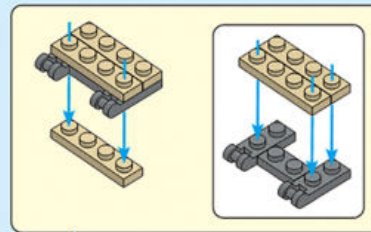

11.

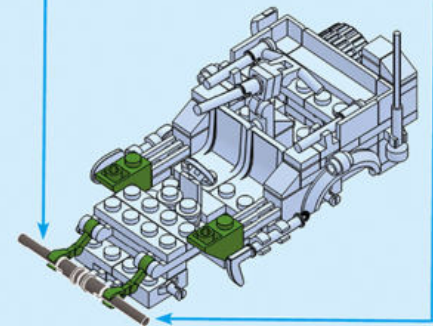
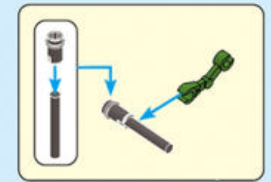
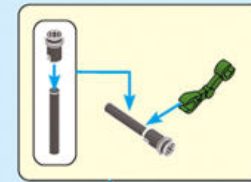



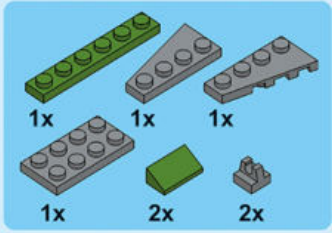

12.

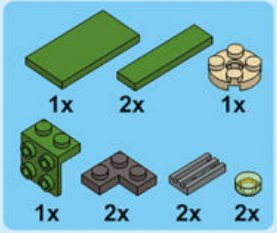
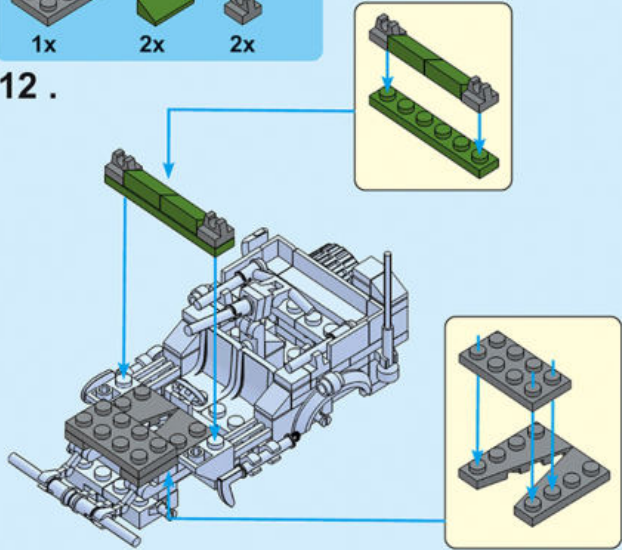

13.

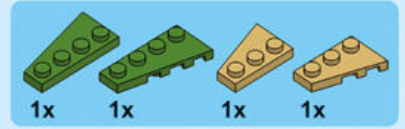
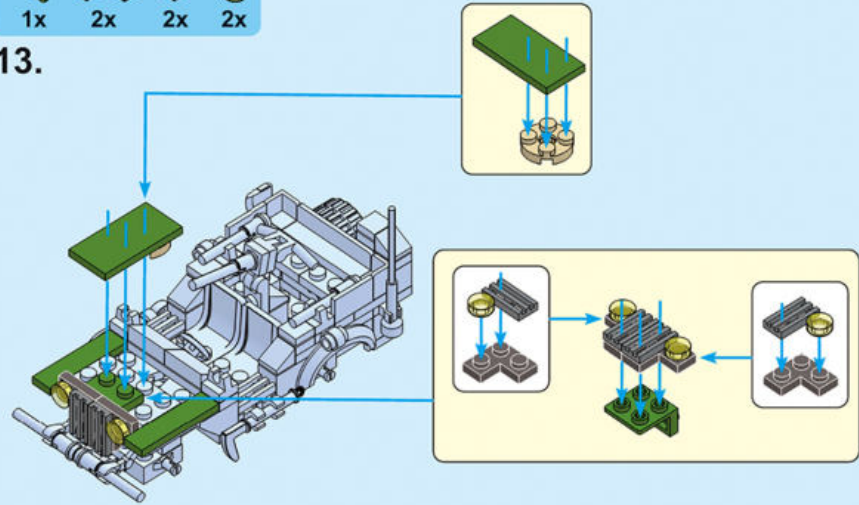

14.

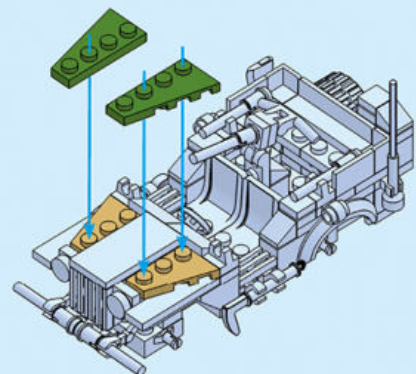

15.

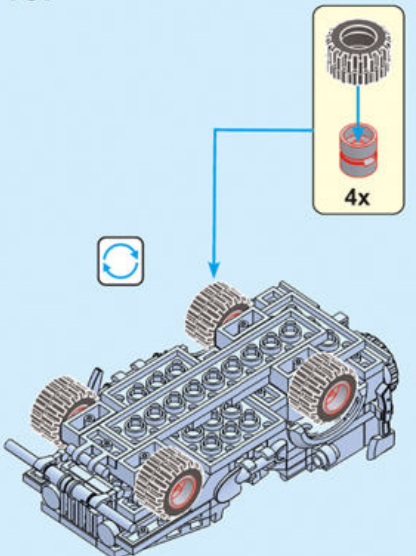

16.

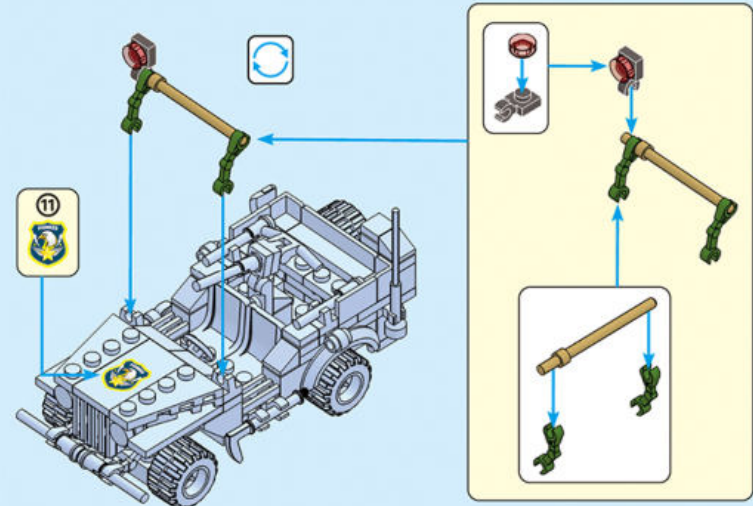

17.

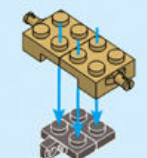

18.

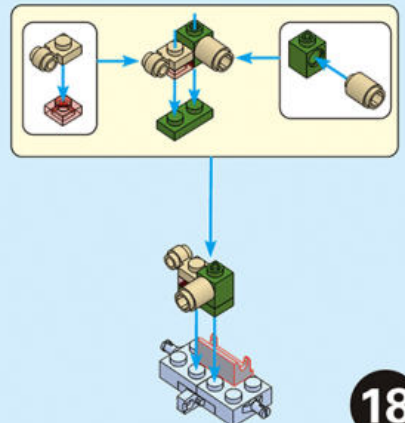



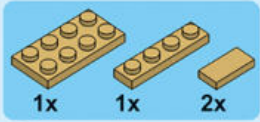

19.

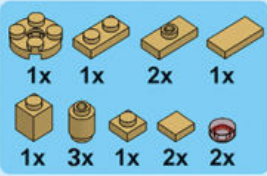
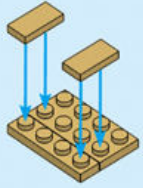

20.

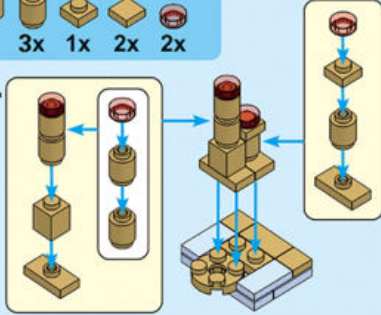

21.

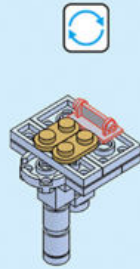

22. 21

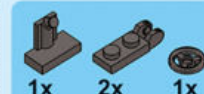
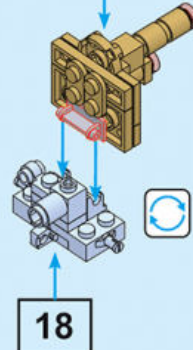

23.

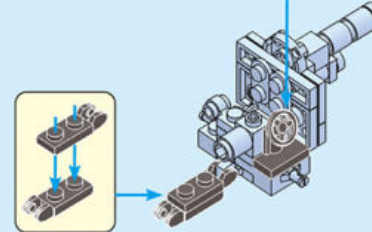

24.

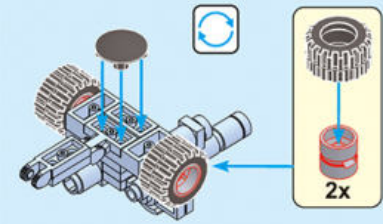

25.

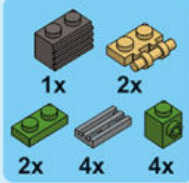
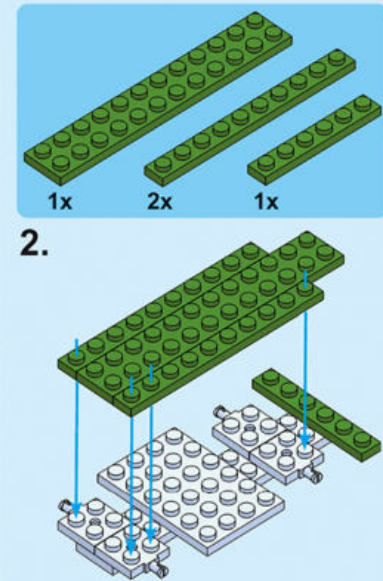
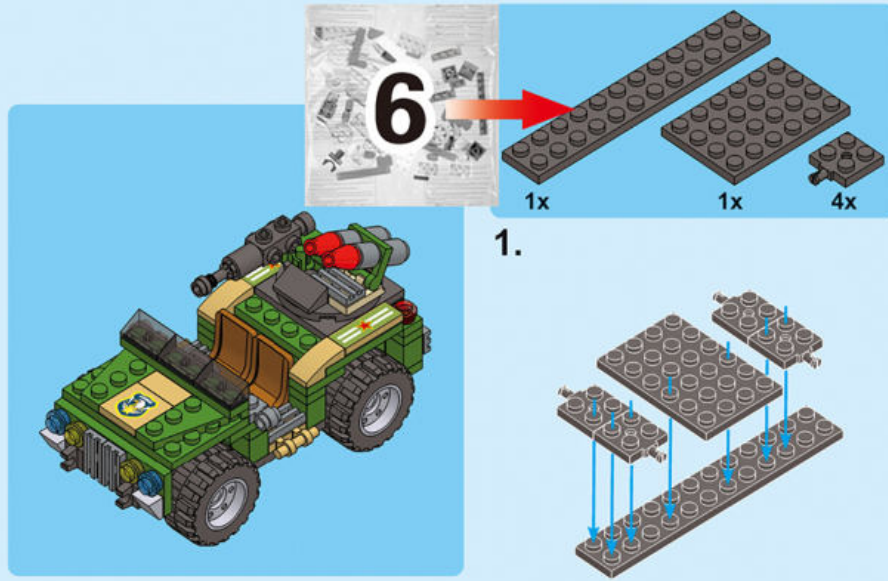
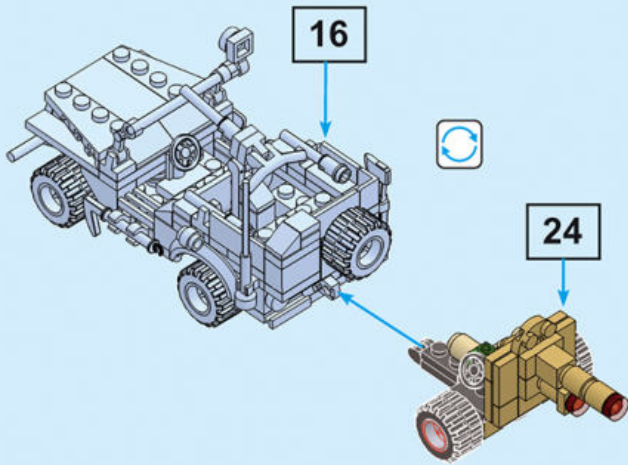

3.

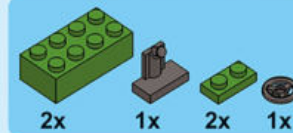
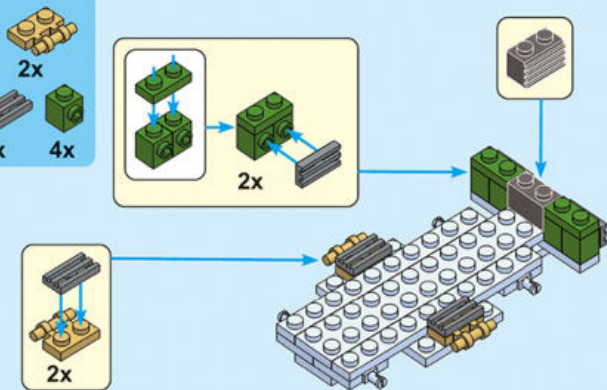

4.

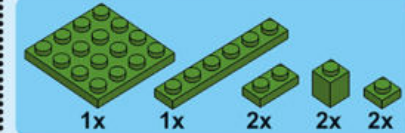
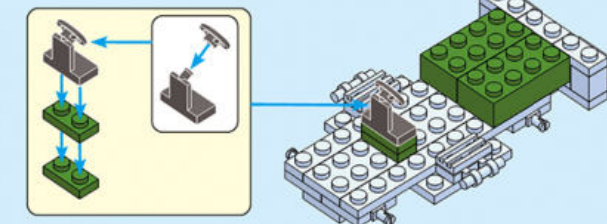

5.

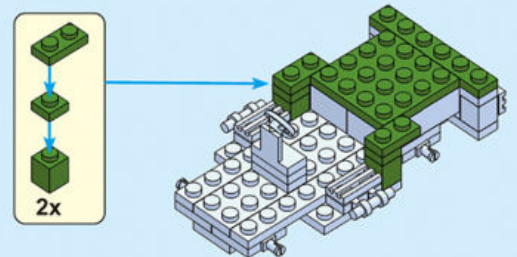



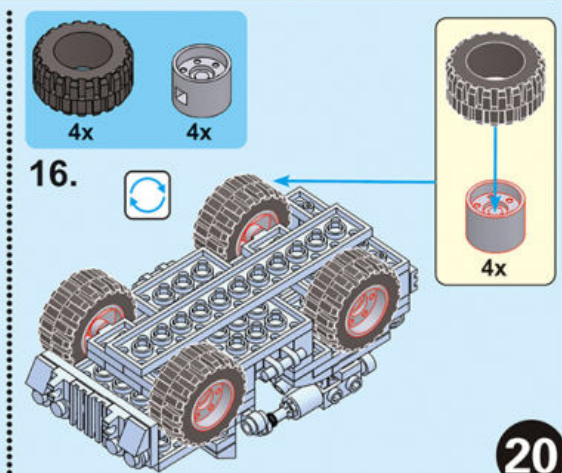
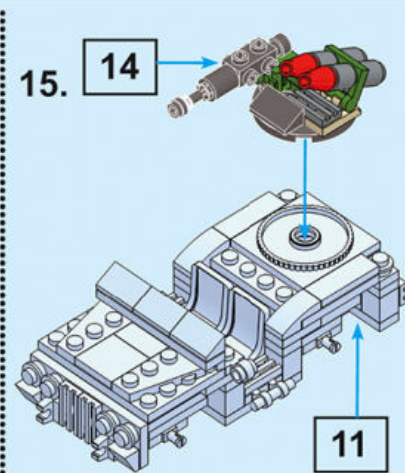
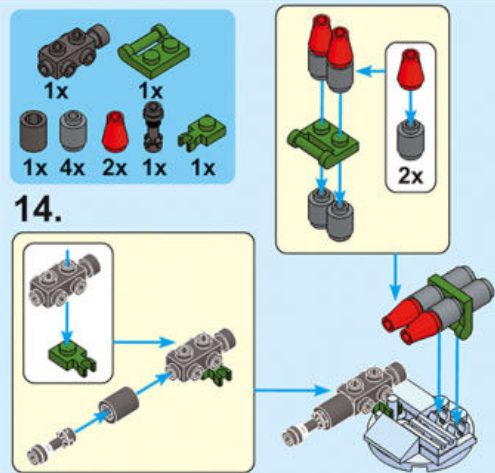
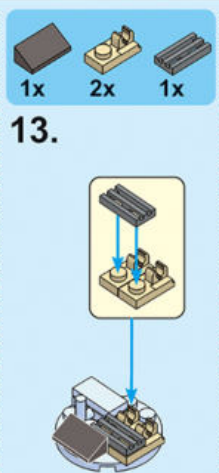
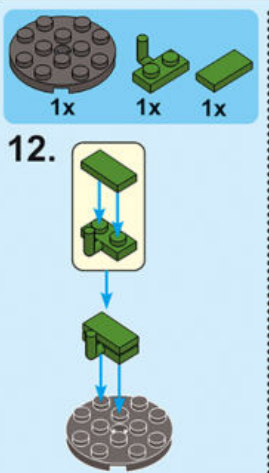
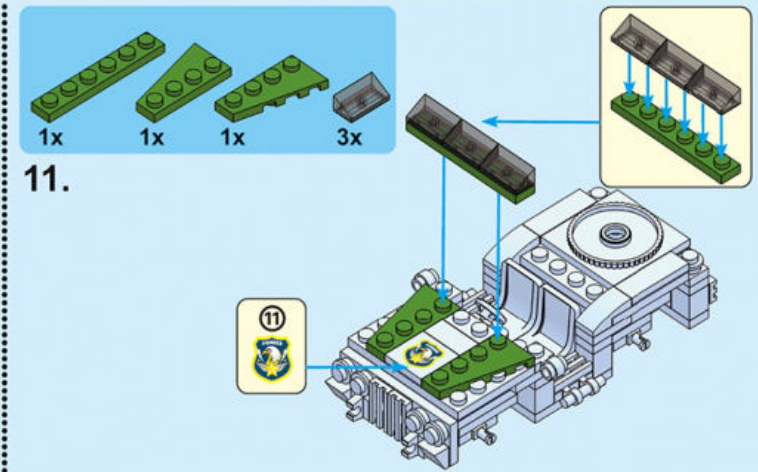
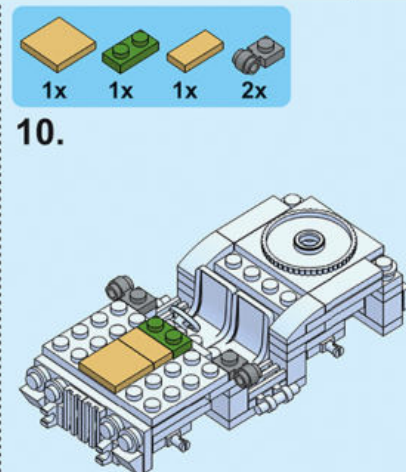
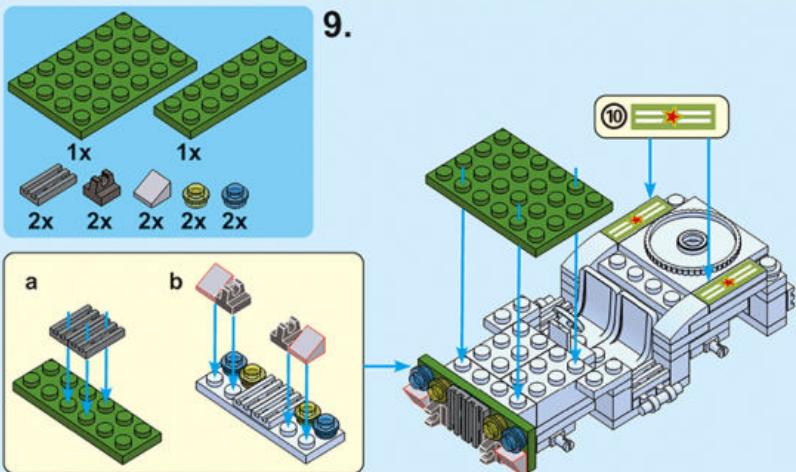
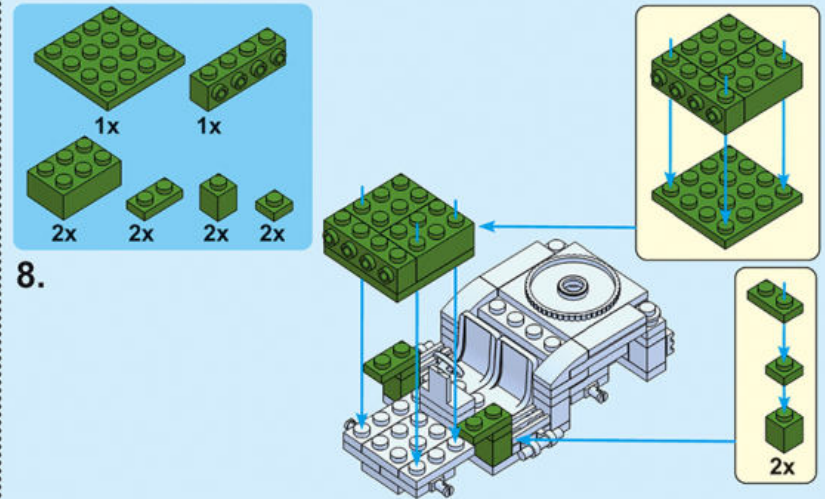
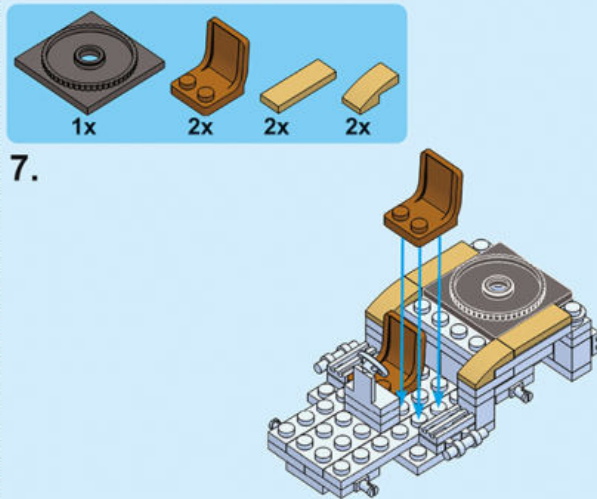
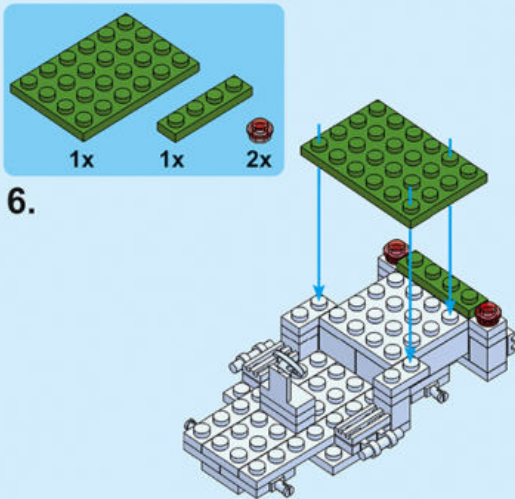



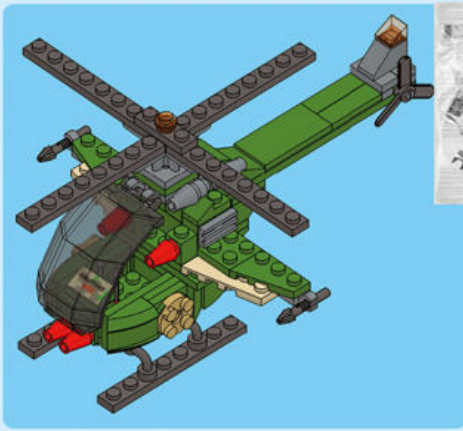

1.

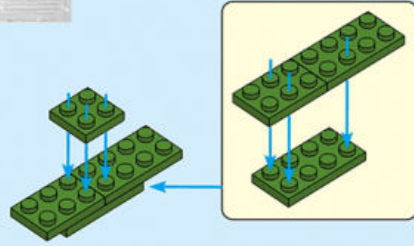
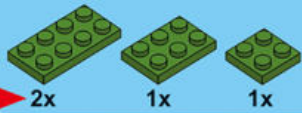

2.

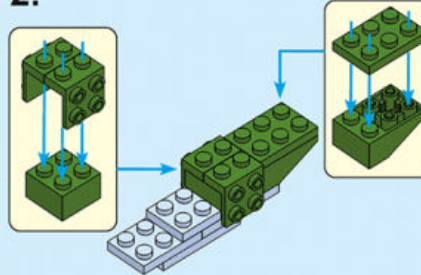
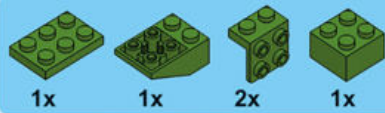

3.

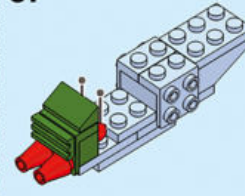
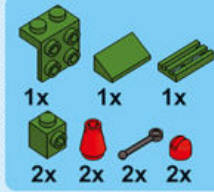

a

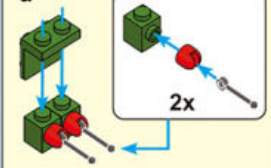

b

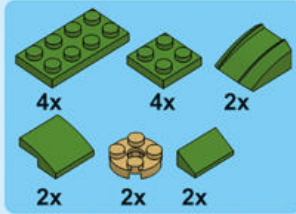
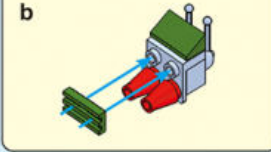

4.

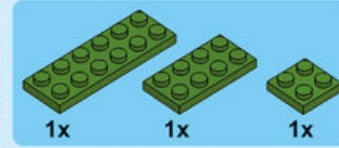
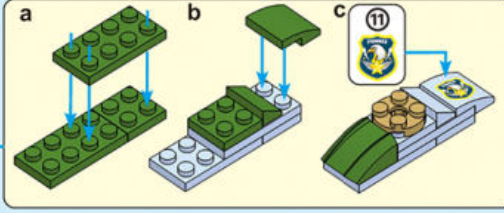
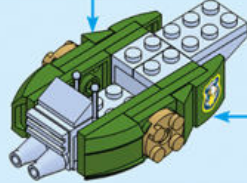
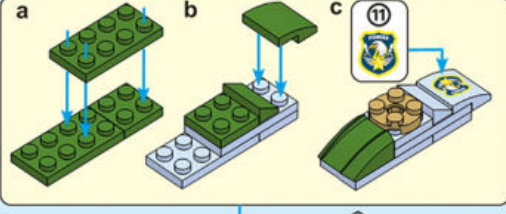

5.

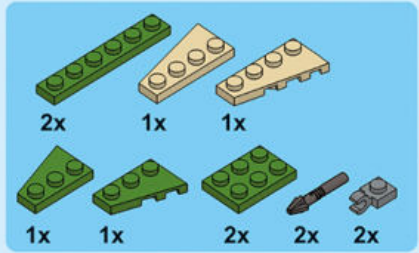
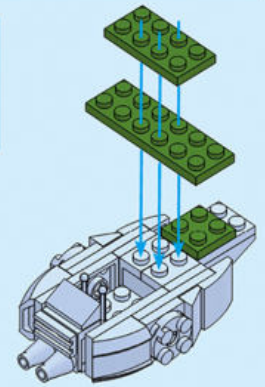

6.

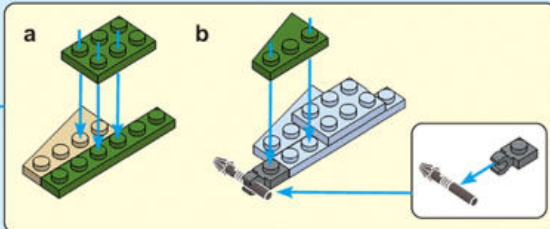
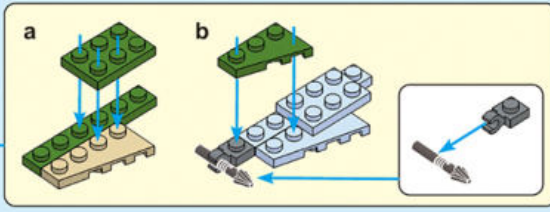

7.

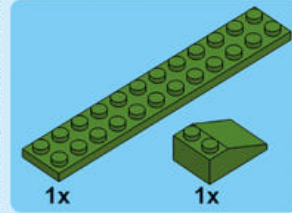
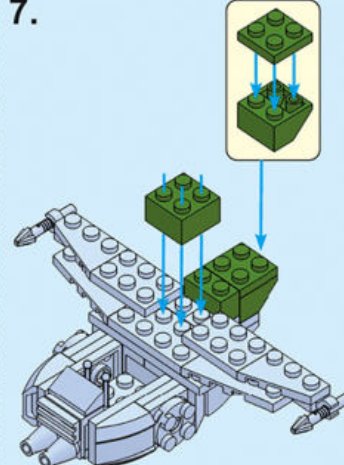

8.

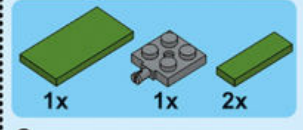
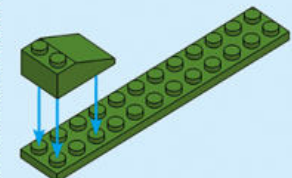

9.

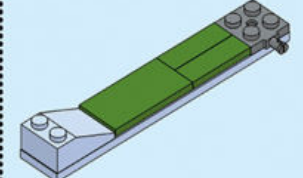



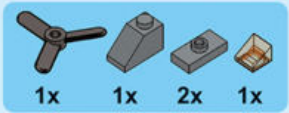

10.

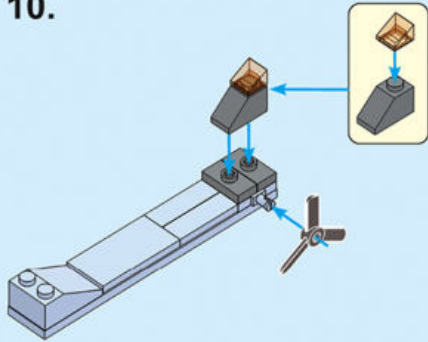

11.

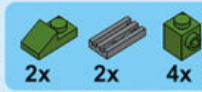
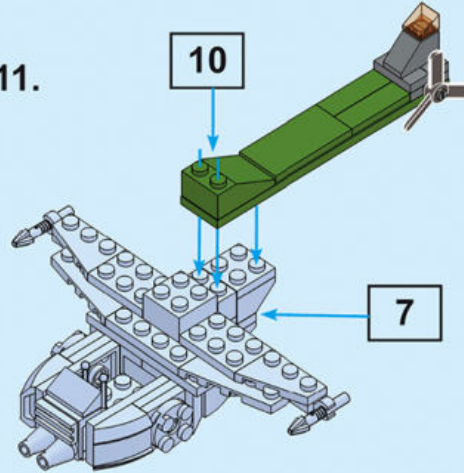

12.

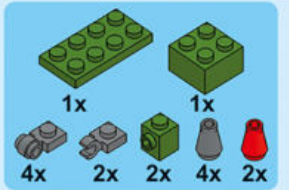
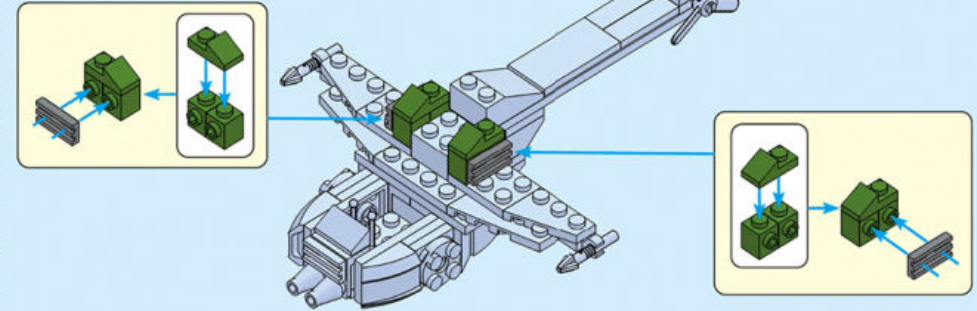

13.

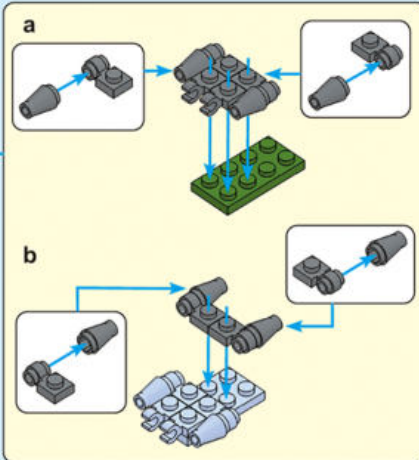
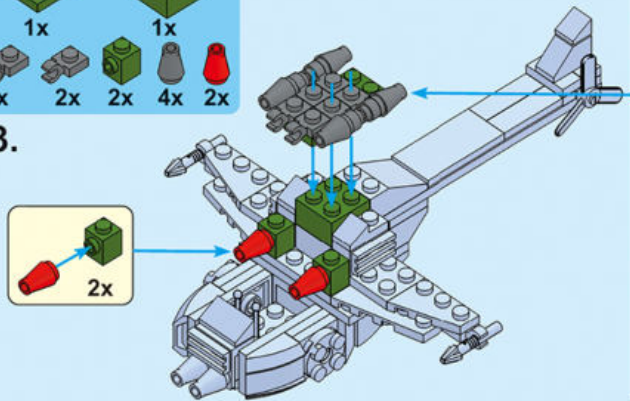

14.

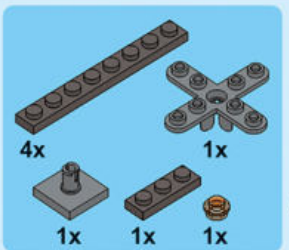
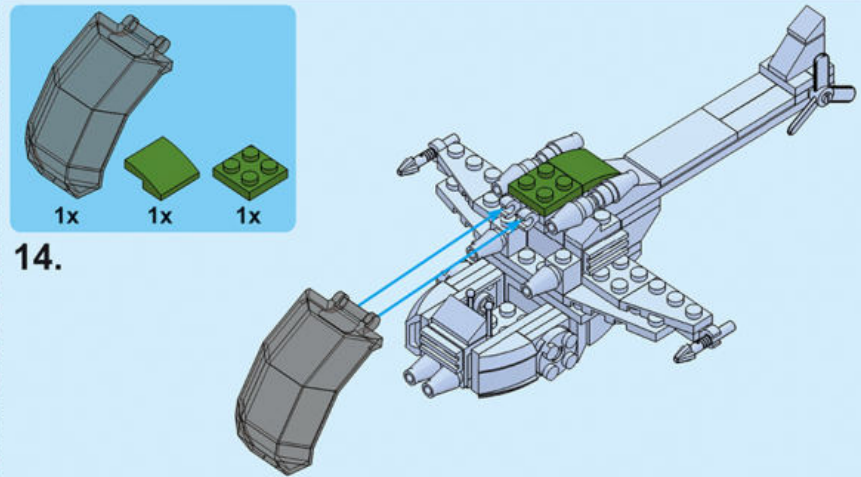

15.

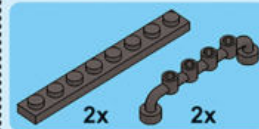
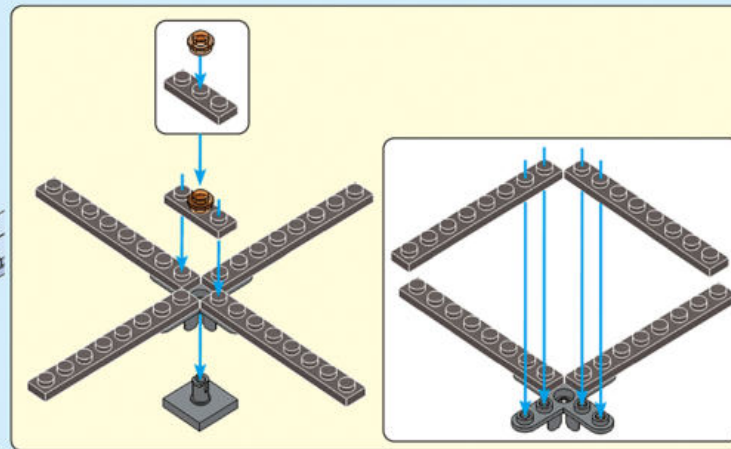
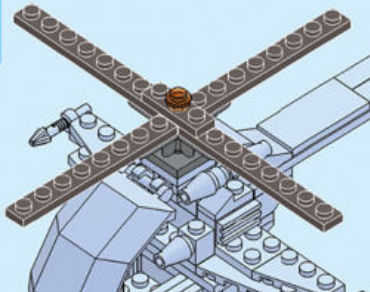

16.

