

11.

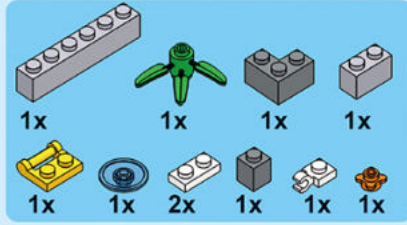

12.

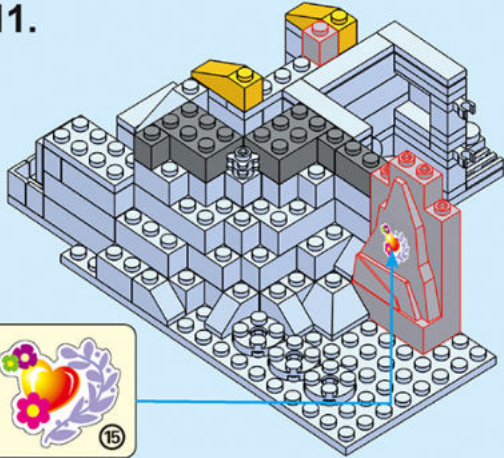
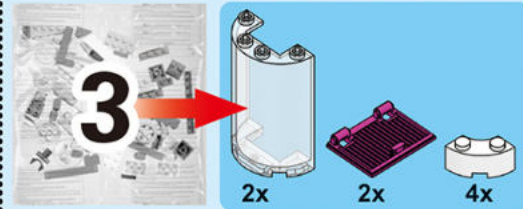
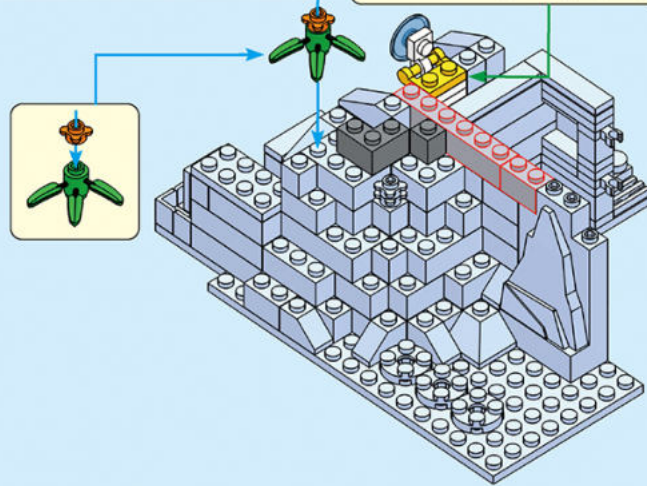

13.

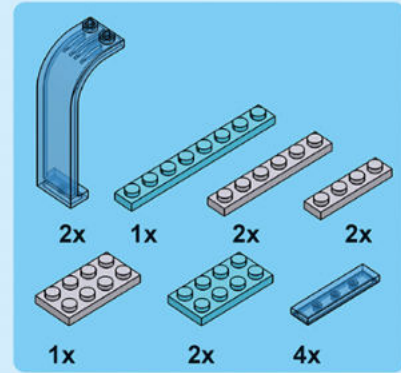
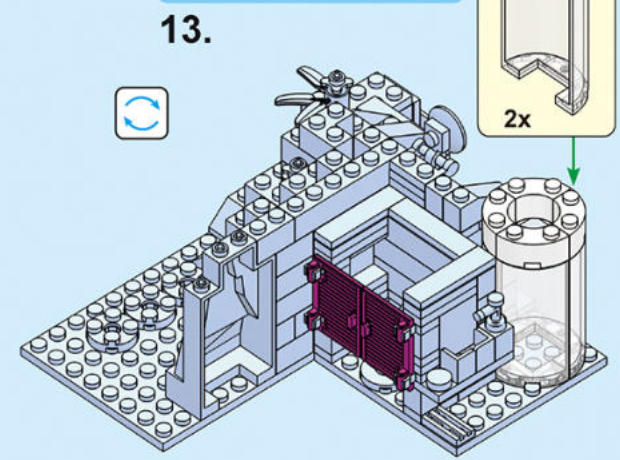

14.

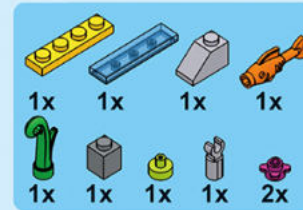
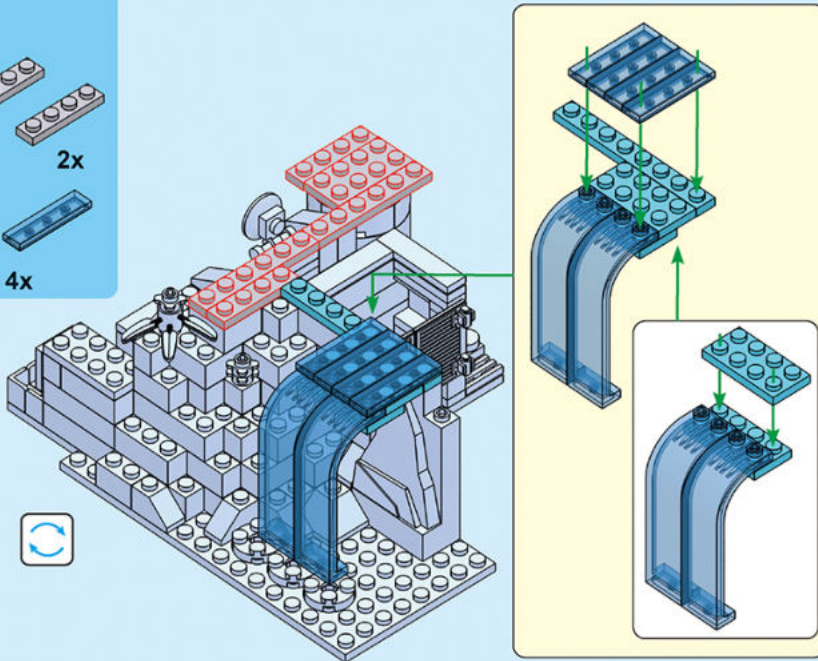

15.

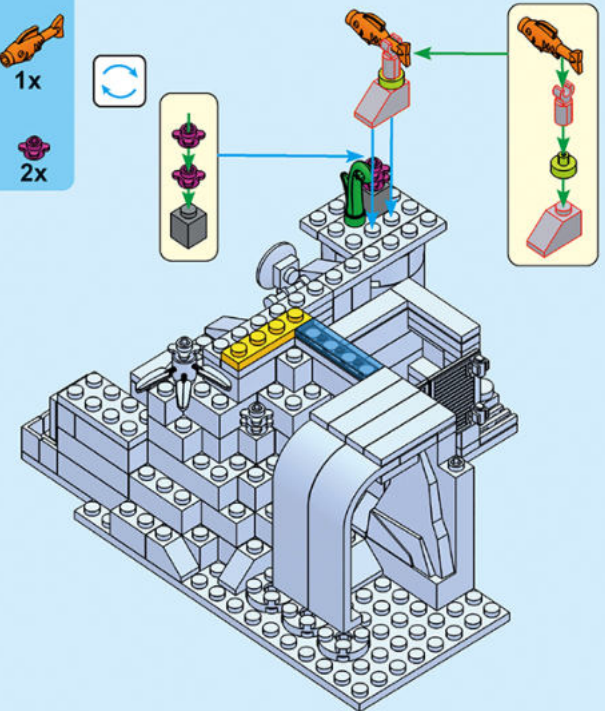



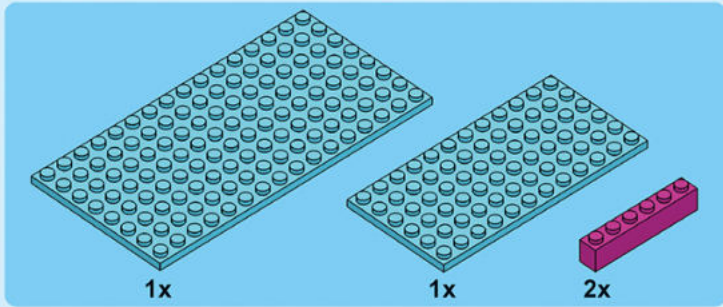

16.

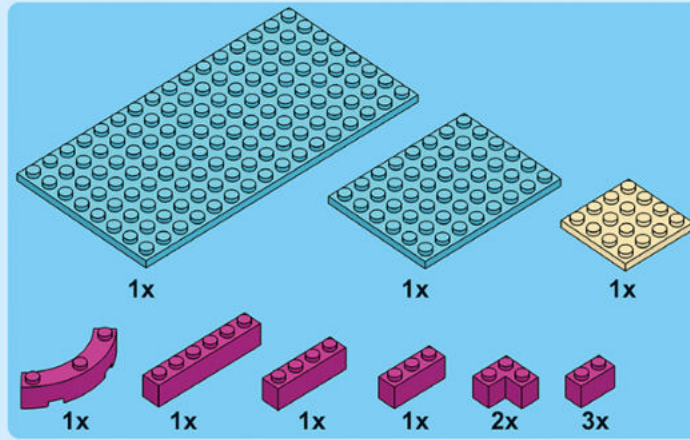
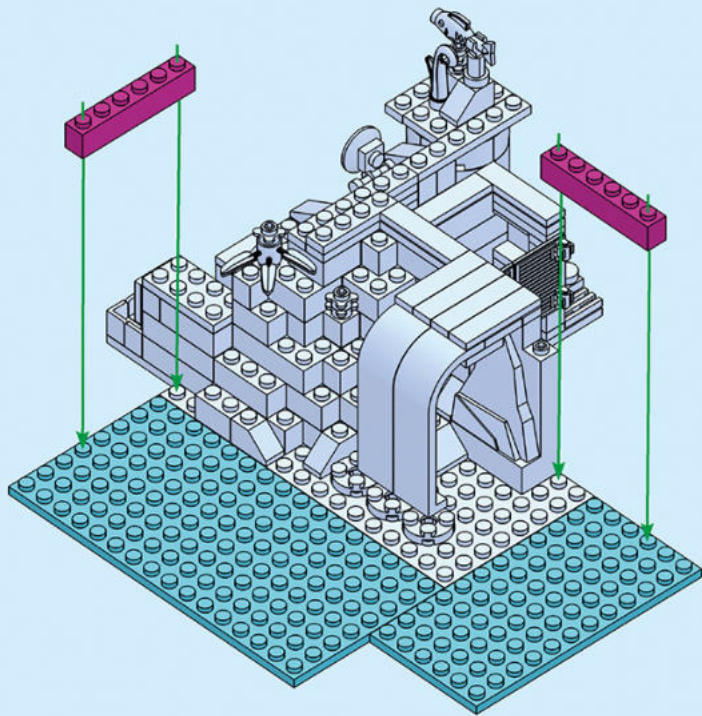

17.

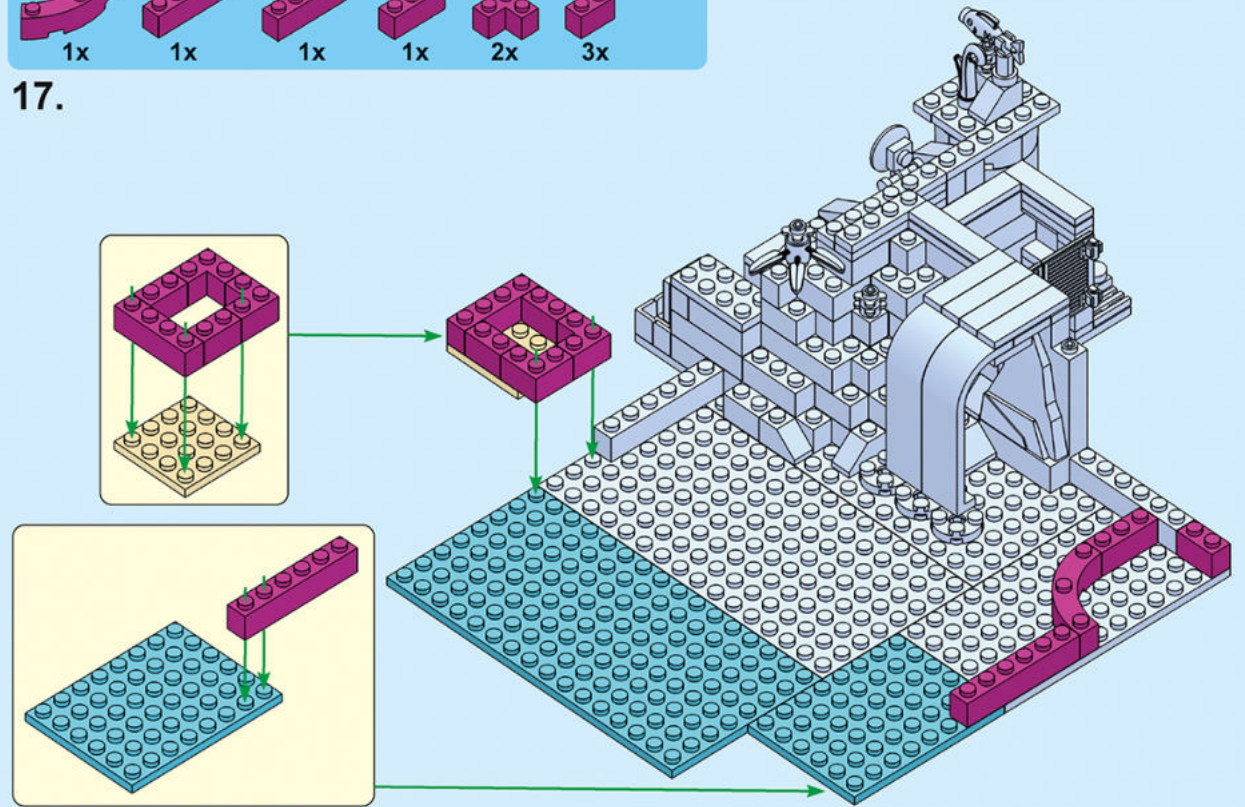



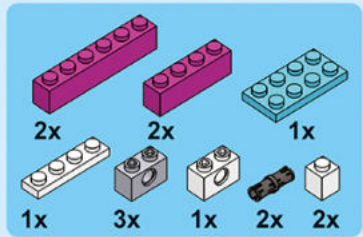

18.

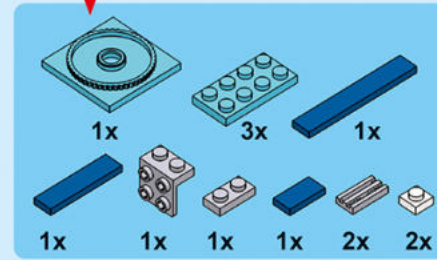
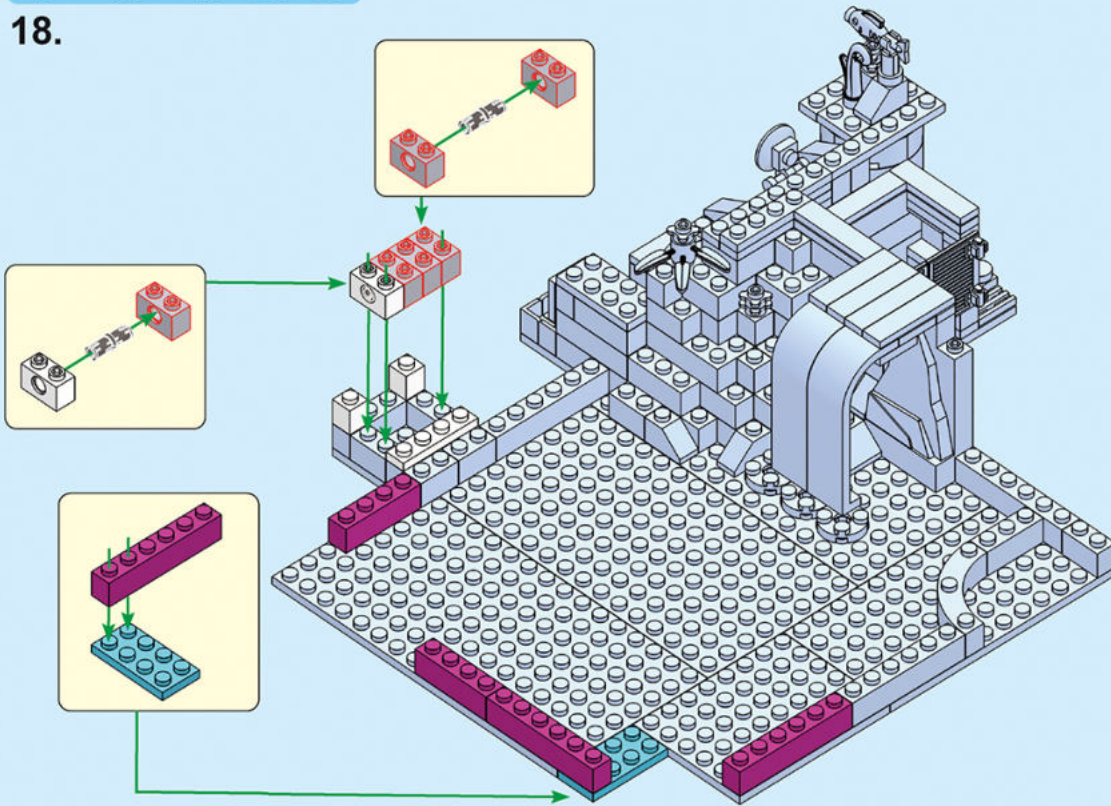

19.

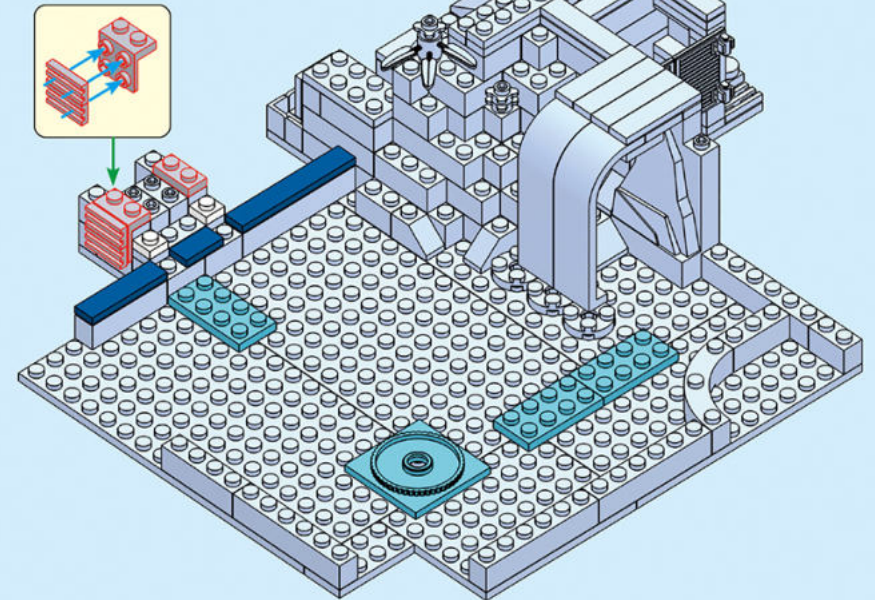



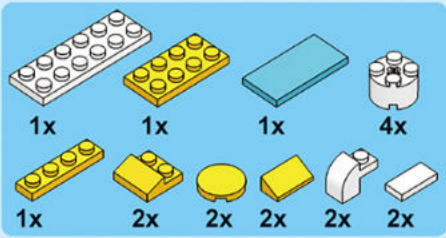

20.

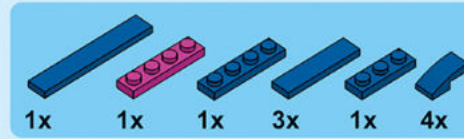
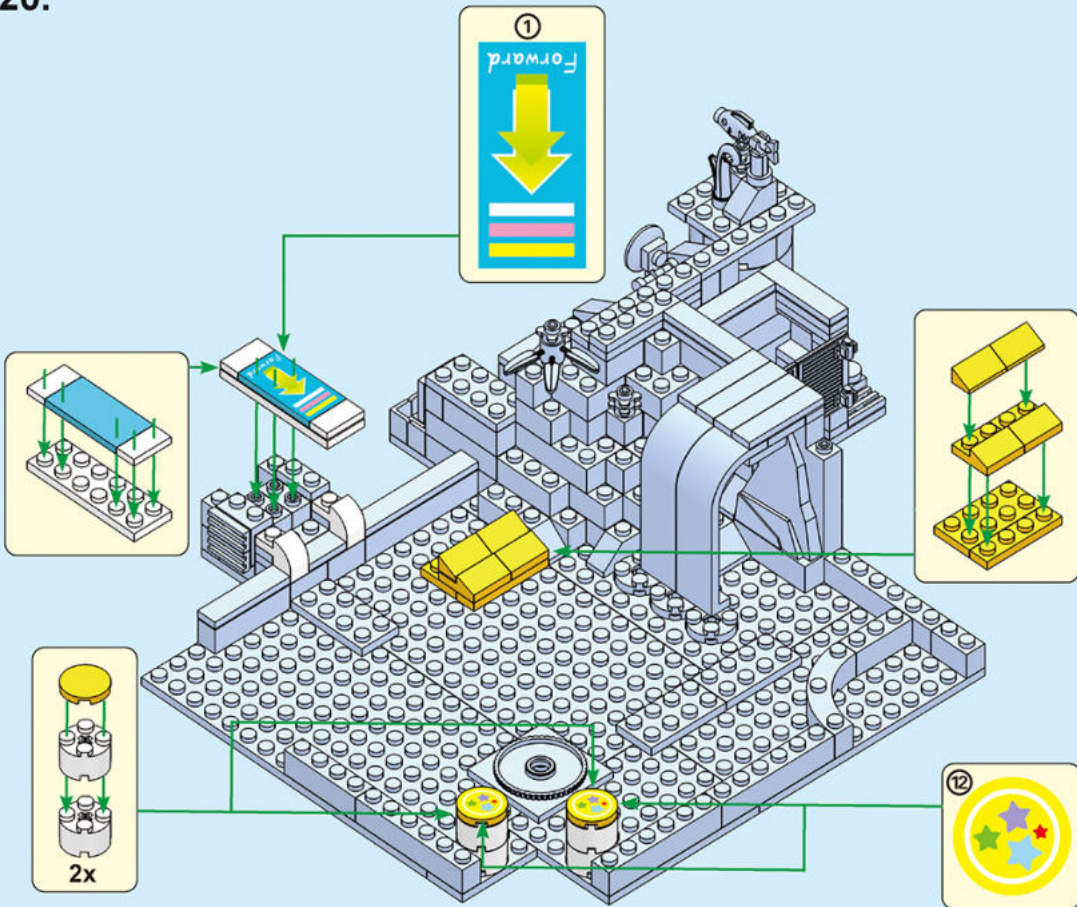

21.

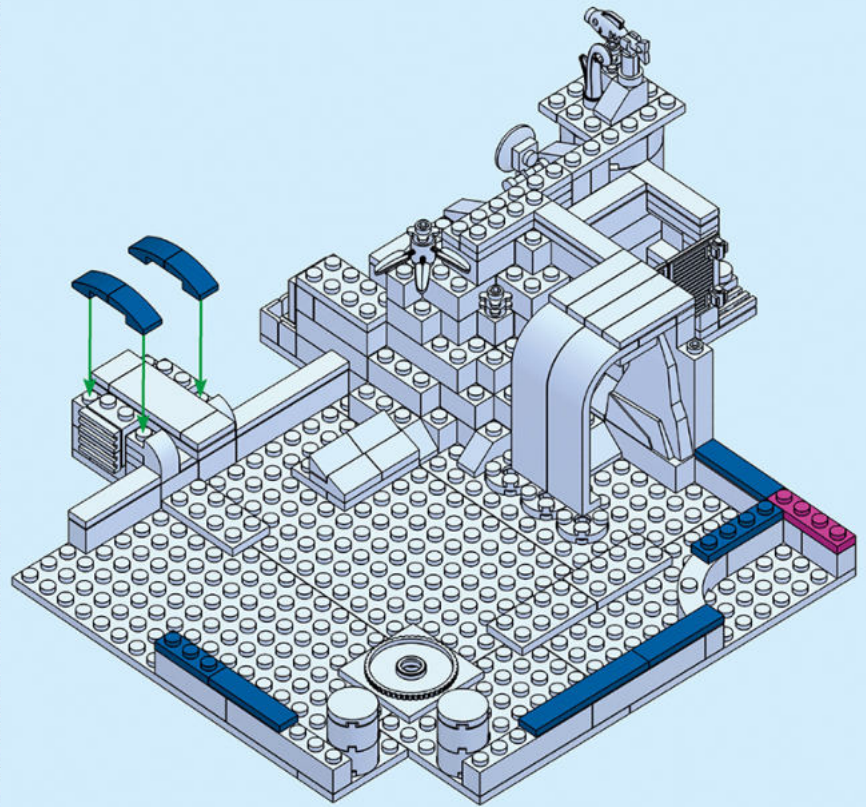



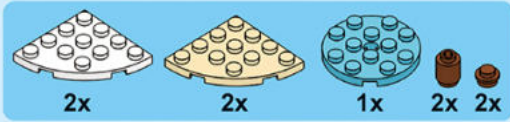

22.

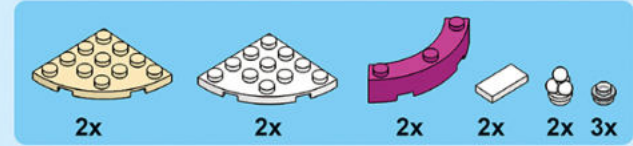
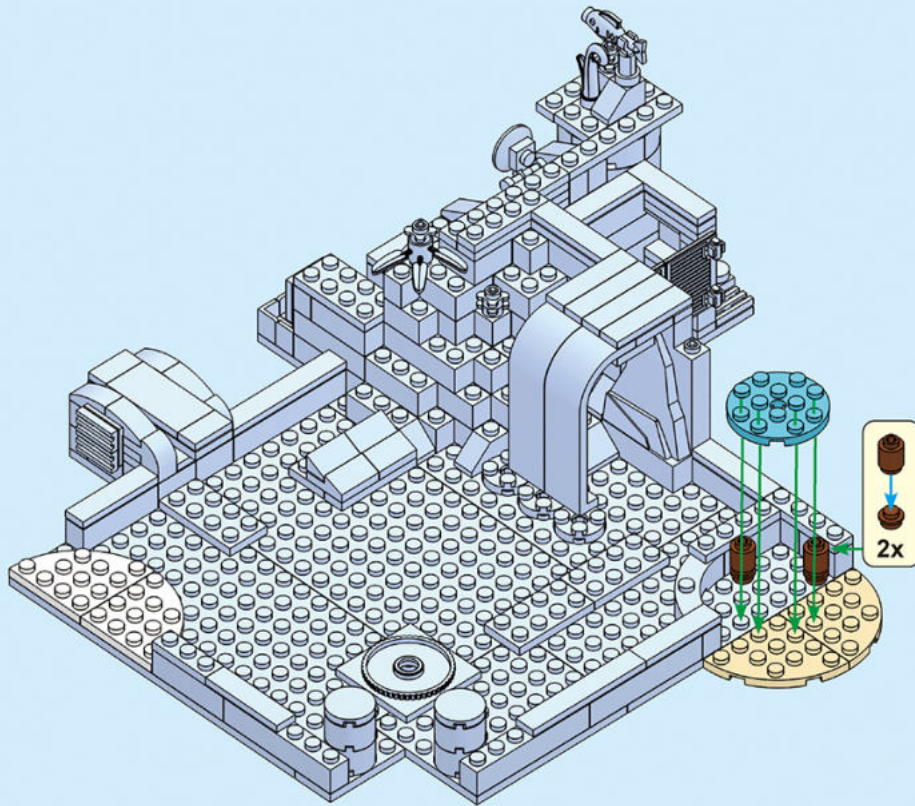

23.

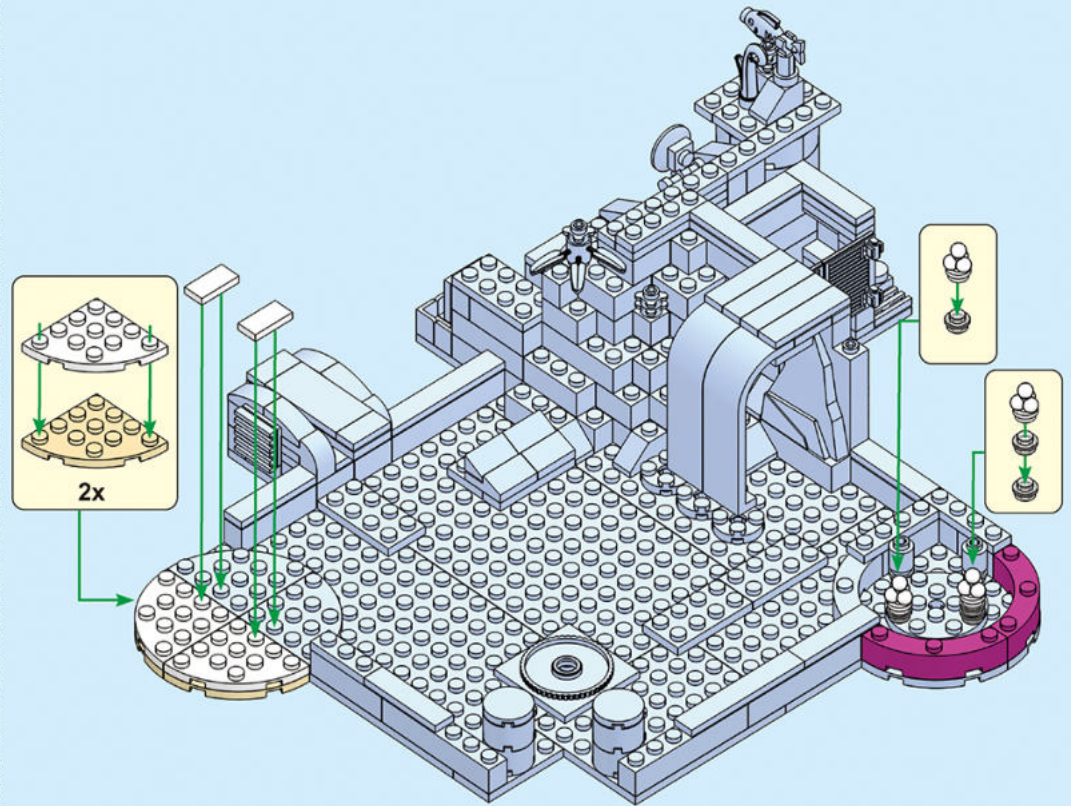



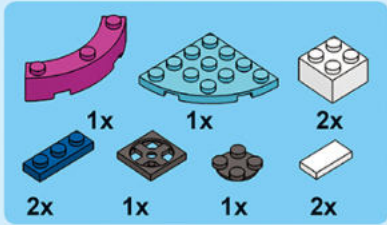

24.

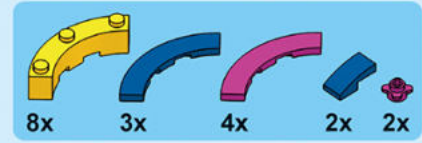
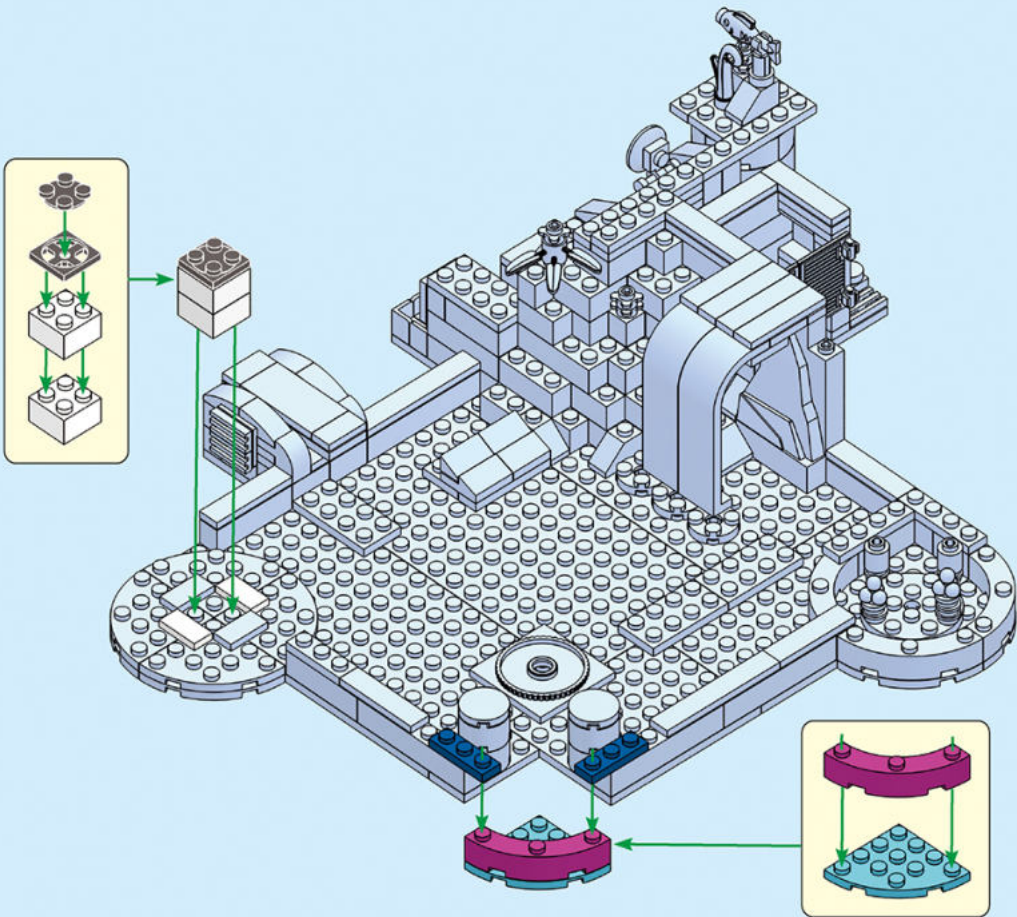

25.

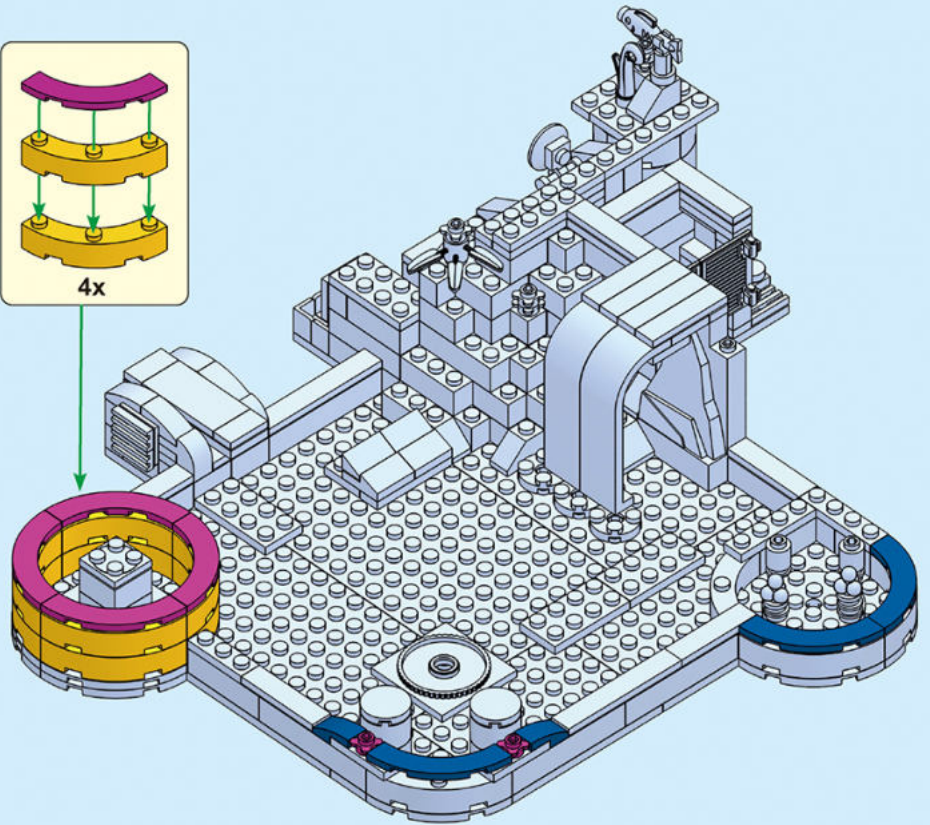
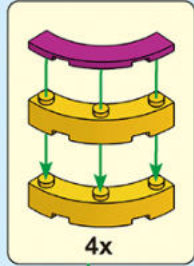



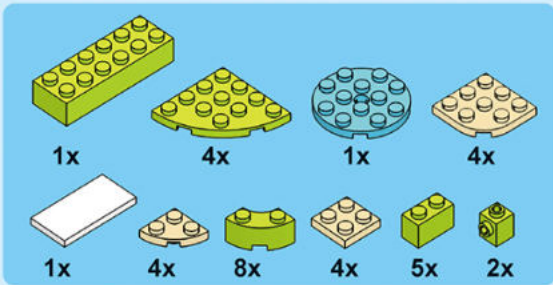

26.

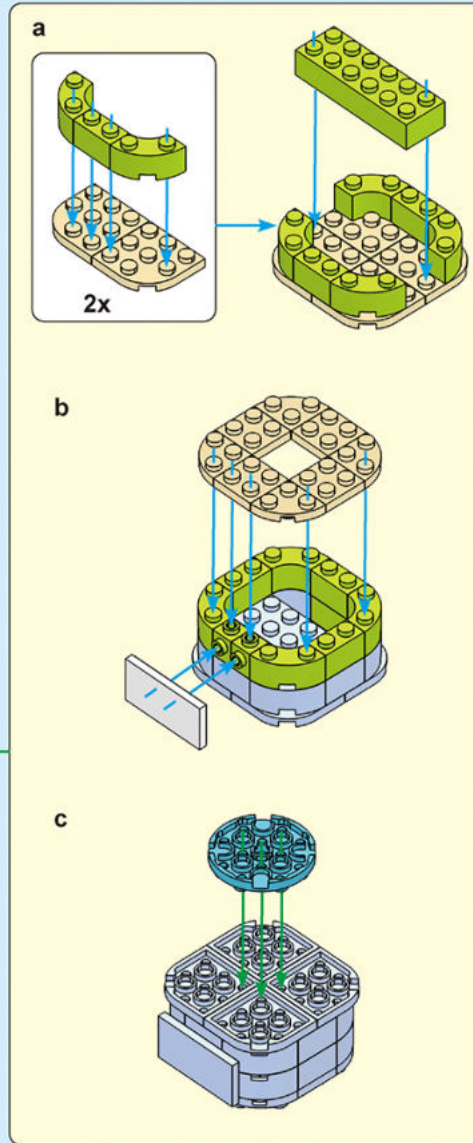
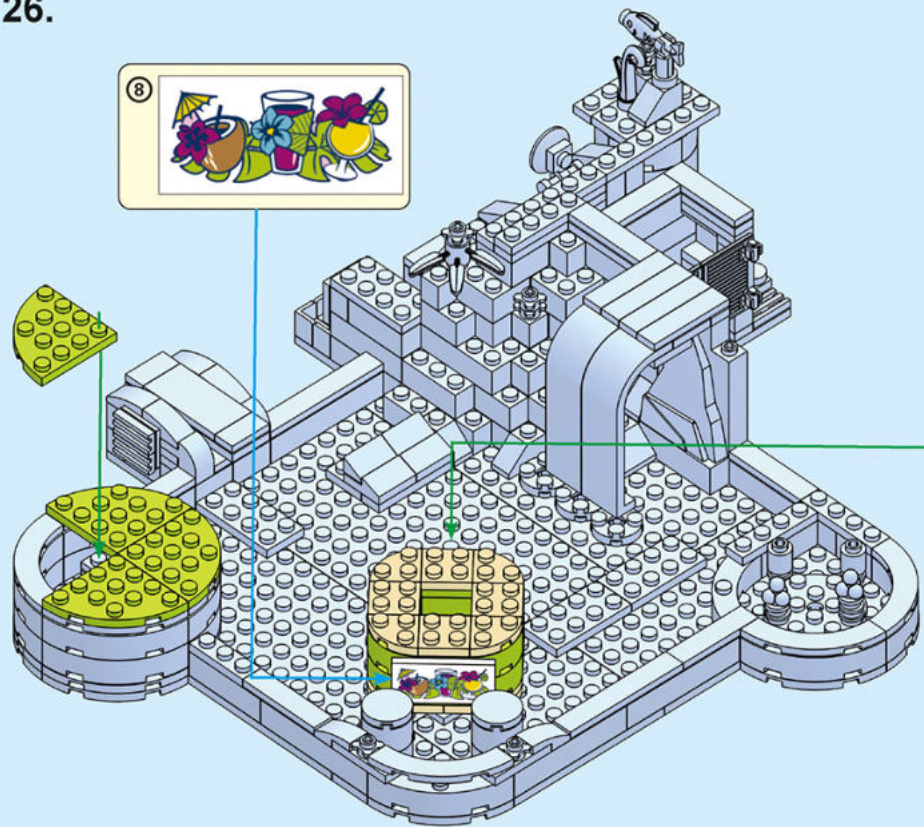



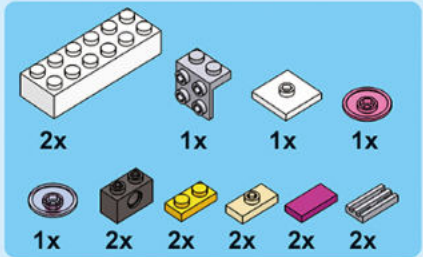

27.

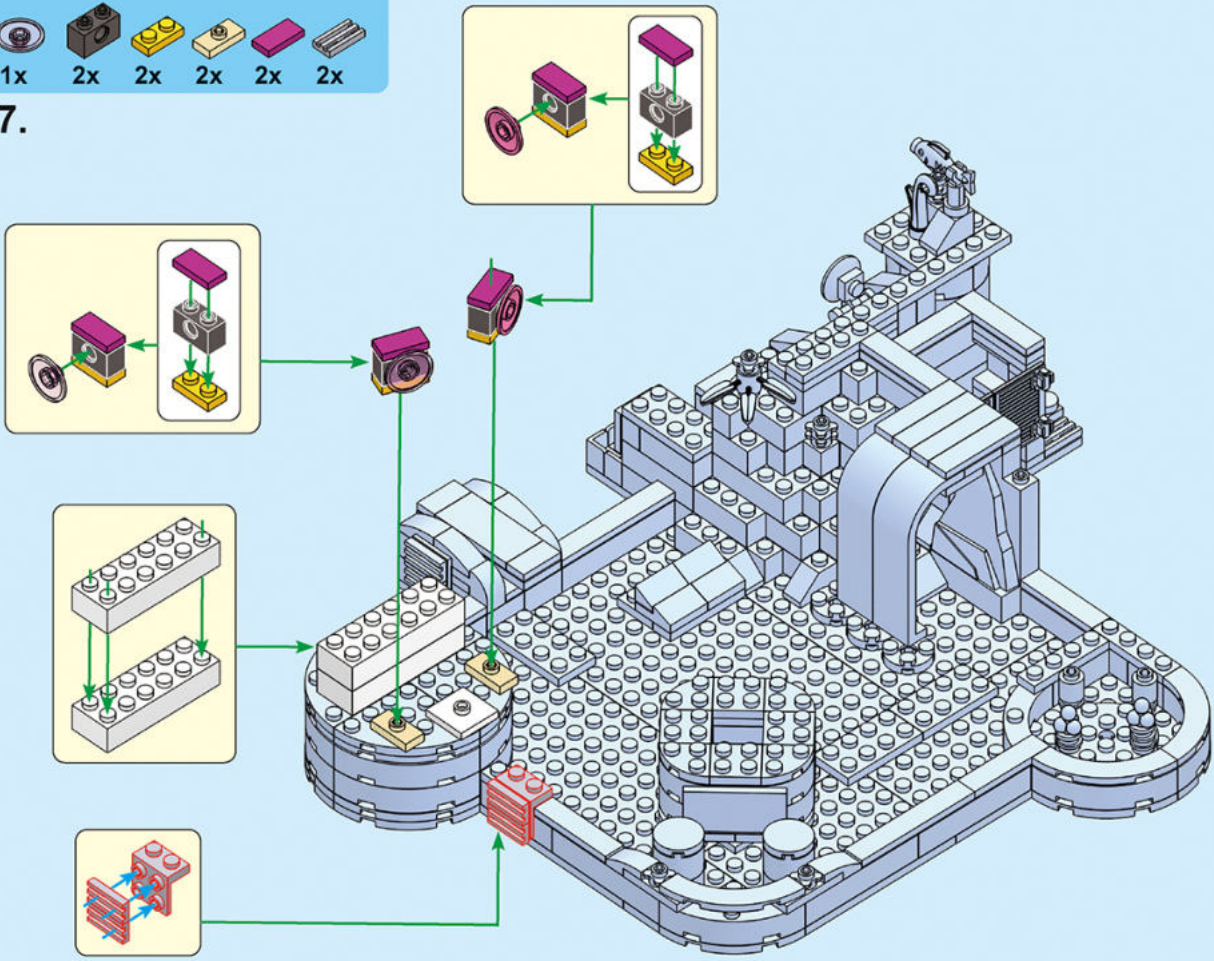



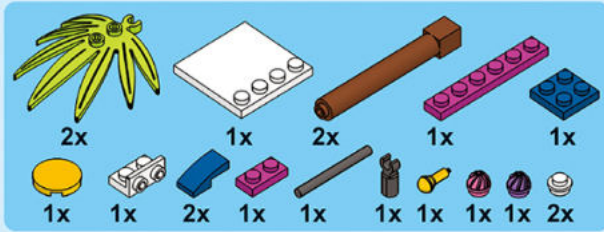

28.

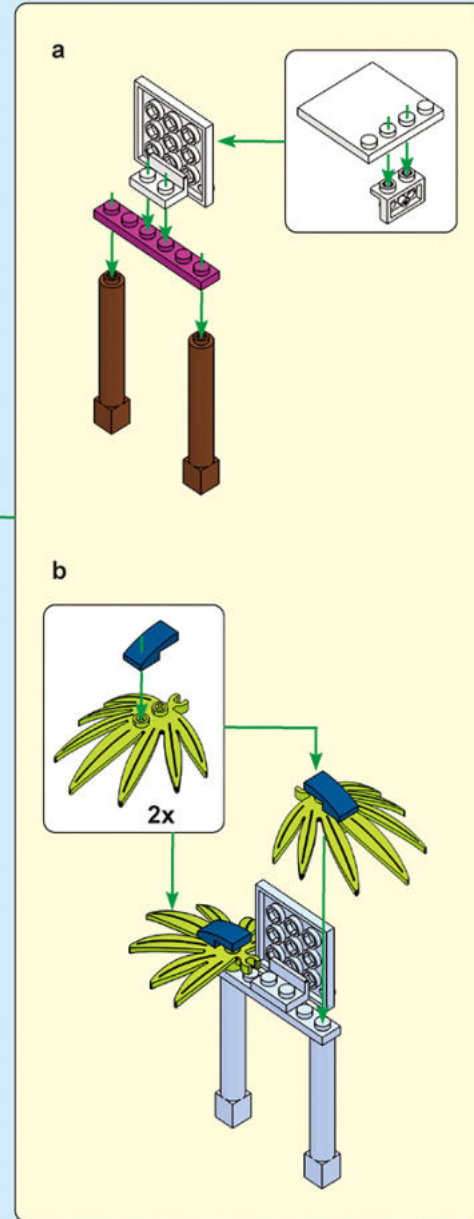
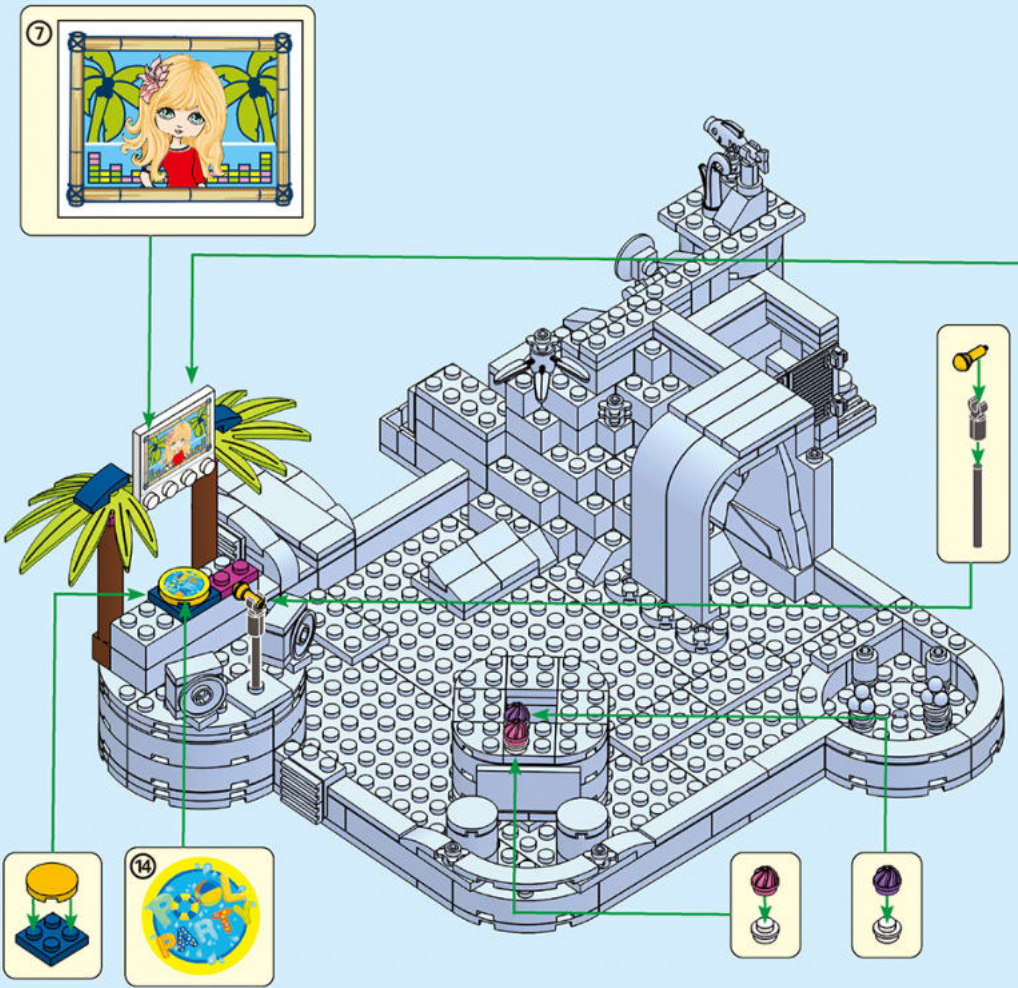







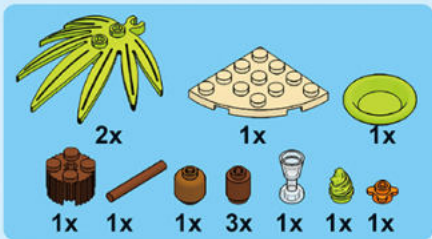

30.

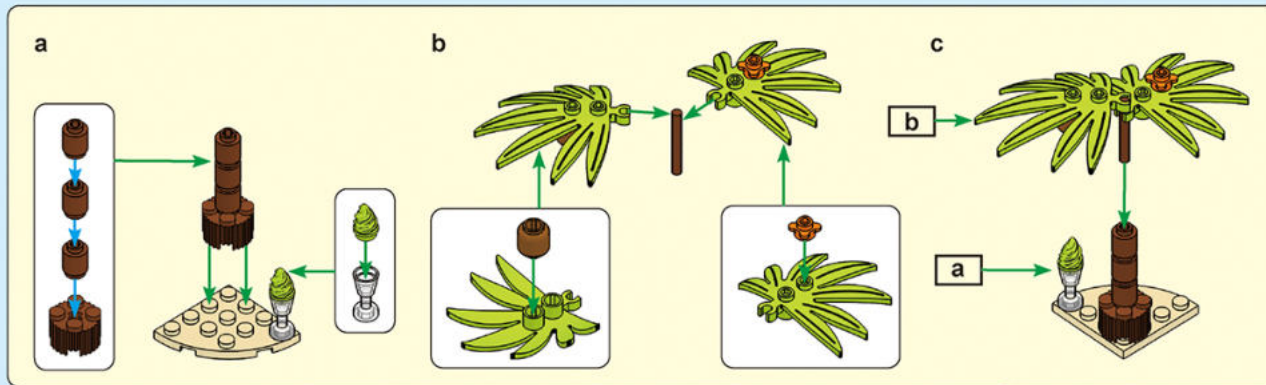



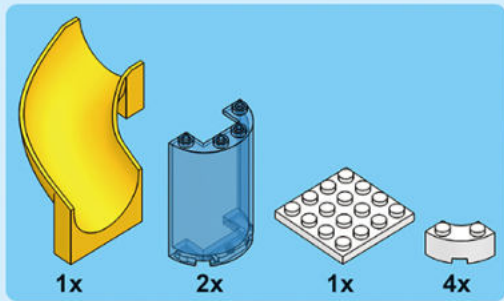

31.

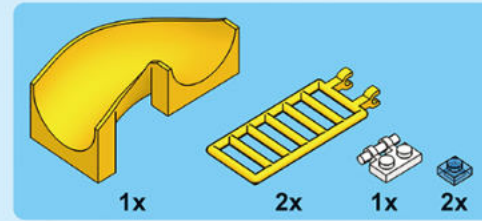
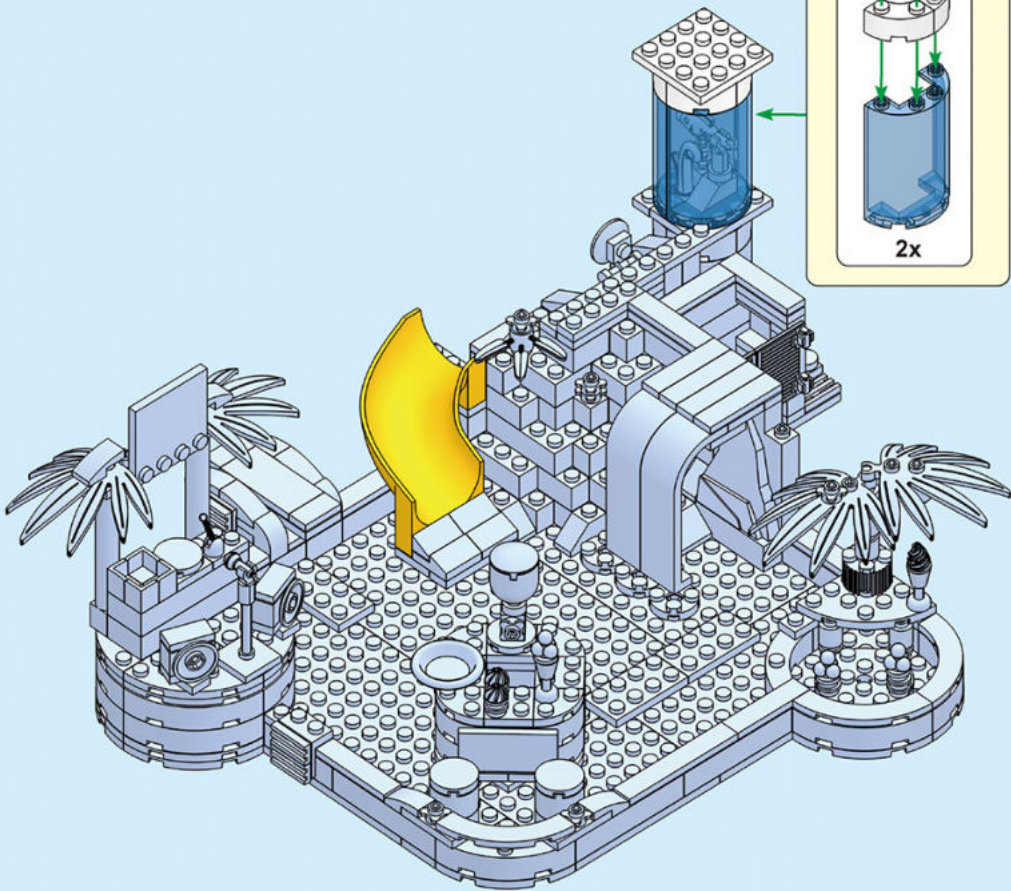
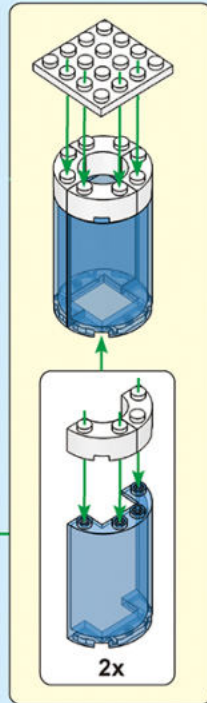

32.

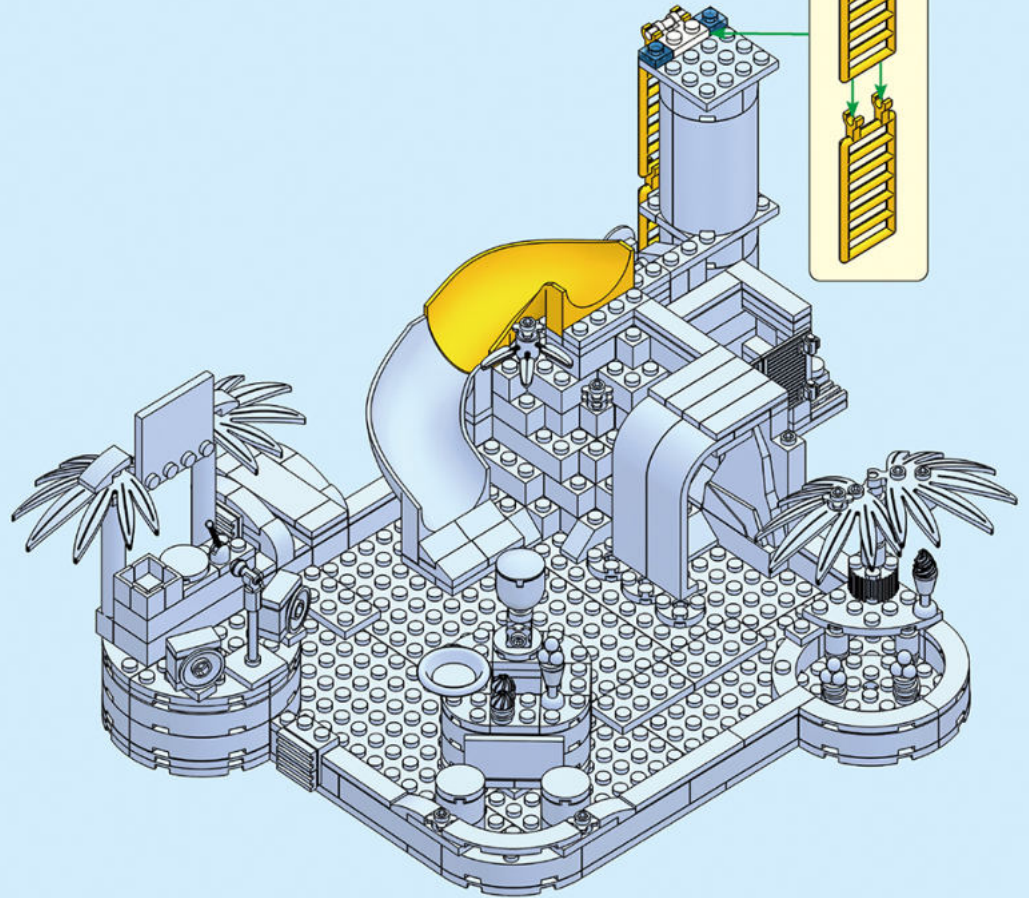
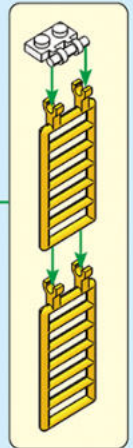



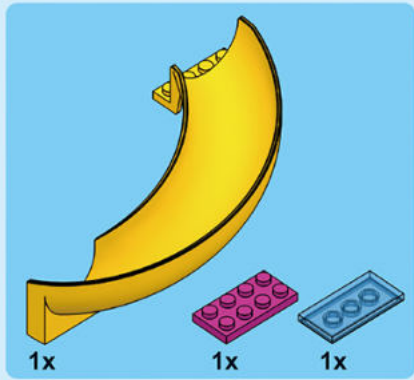

33.

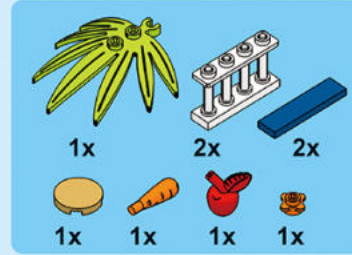
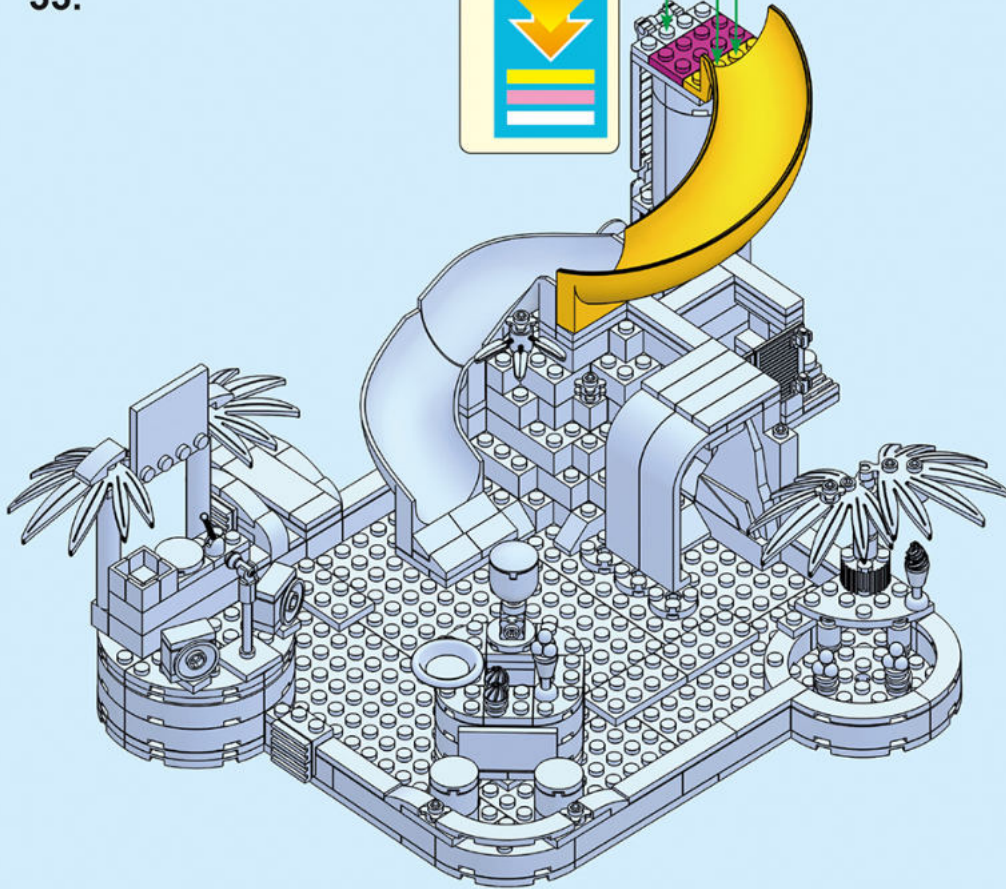
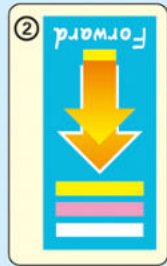

34.

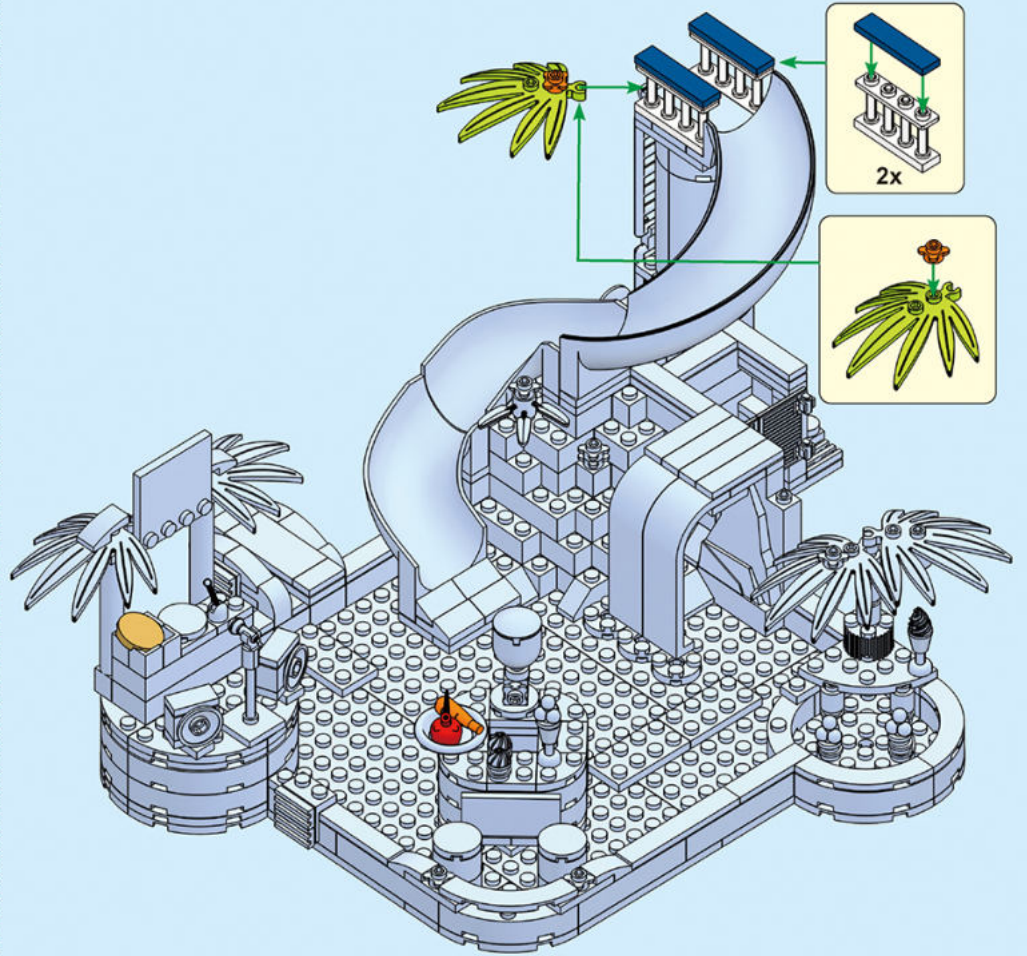
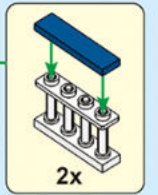

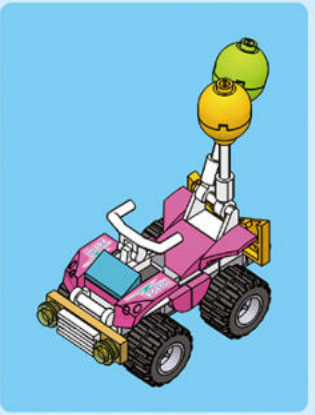

1. 2x 2x

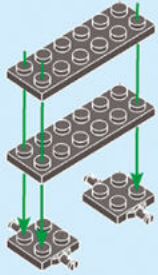

2. 1x 2x 1x 1x 2x

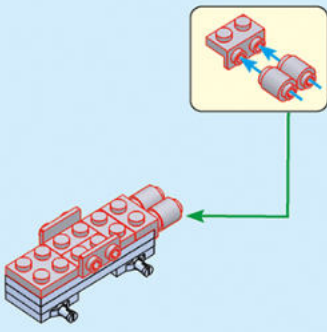

3. 1x 1x 1x

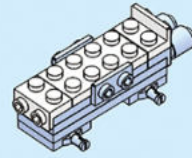

4. 1x 1x 1x 1x 4x

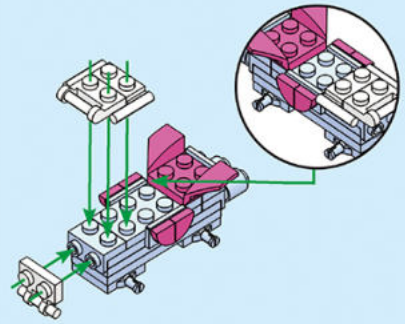

5. 1x 1x 1x 1x 2x 2x

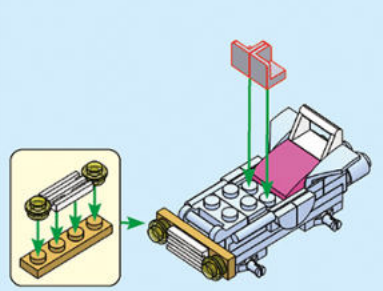

6. 1x 1x 1x 1x 1x

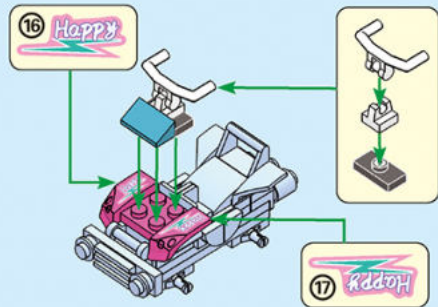

7. 1x 1x 1x 1x 1x 1x 2x 2x

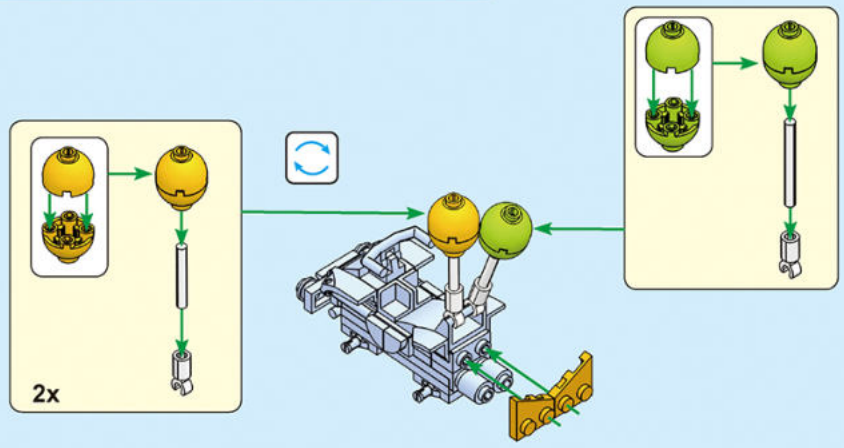

8. 4x 4x

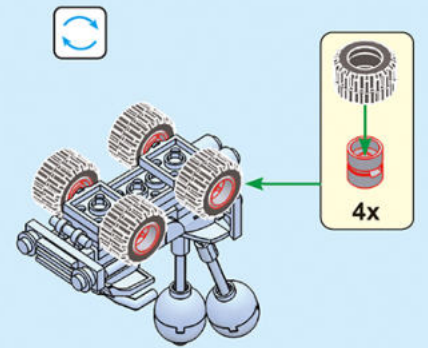



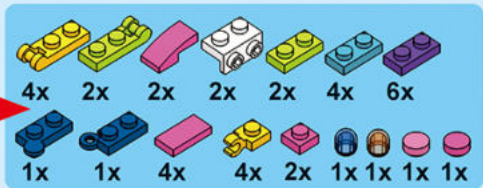
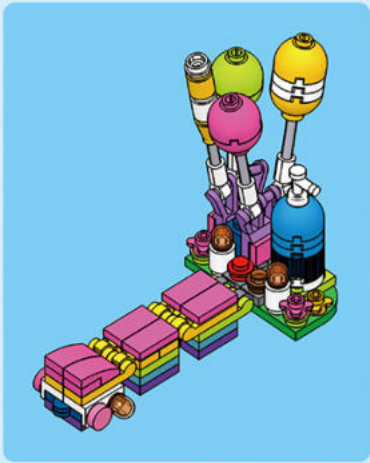

1.

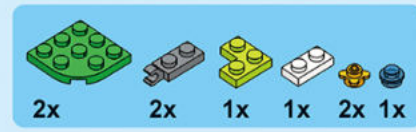
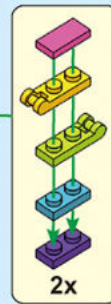
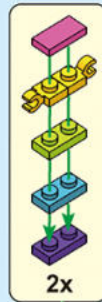
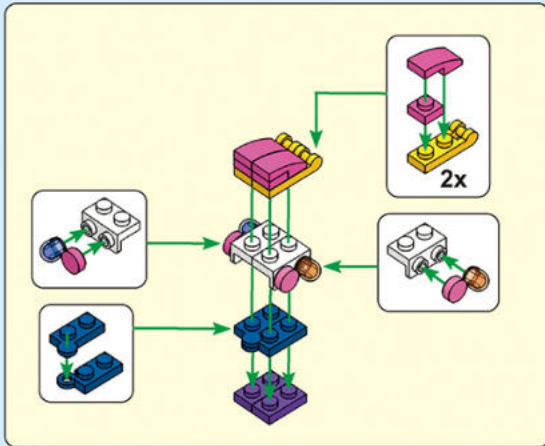

2.

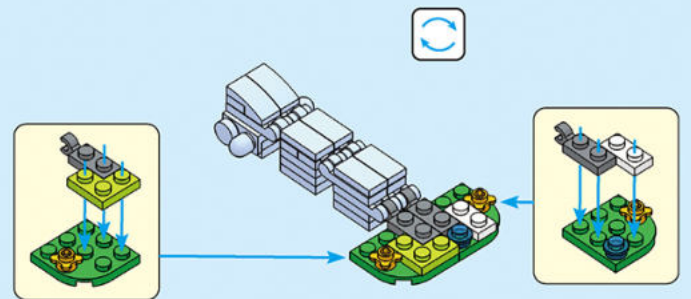

- 2x 2x 2x 1x 1x 2x

3.

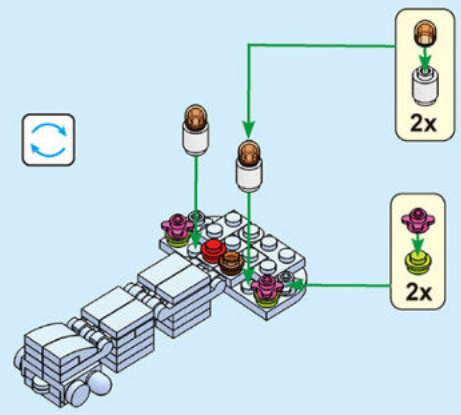

- 2x 1x 1x 2x 1x 2x 2x 1x

4.

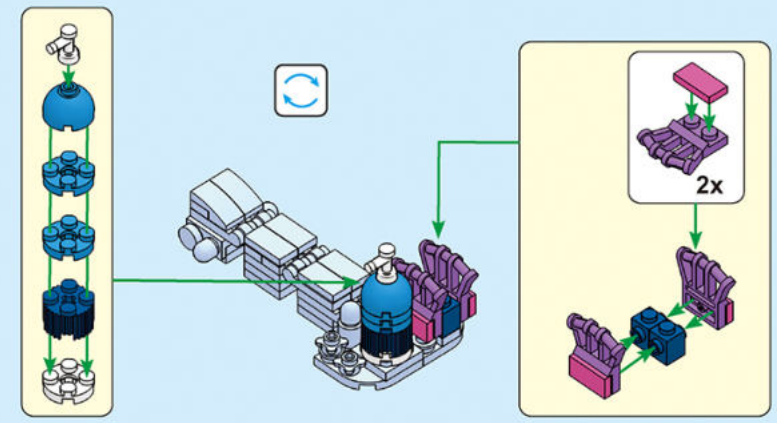

- 1x 1x 1x 1x 1x 1x
- 2x 4x 1x 1x 1x 4x 1x

5.

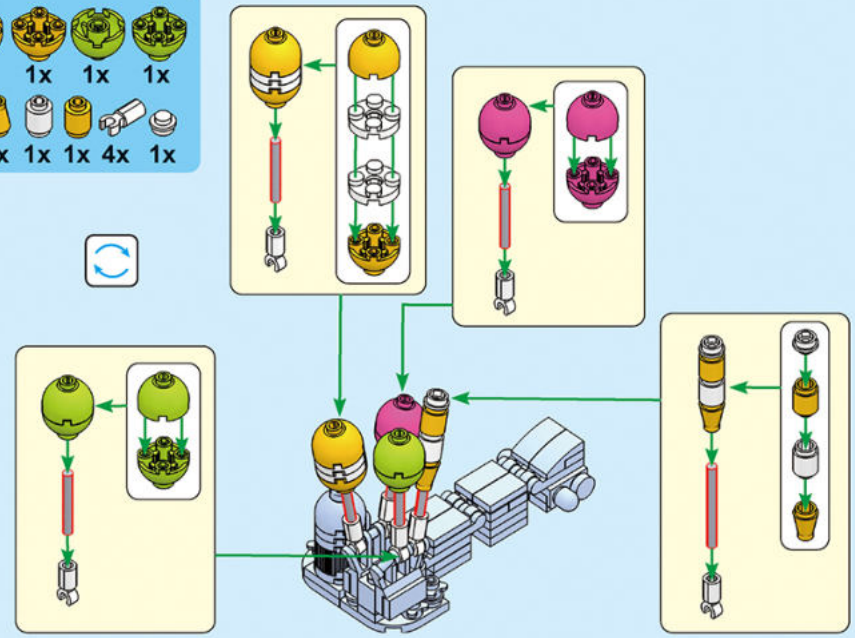

- 1x 1x 1x 1x 2x

1.

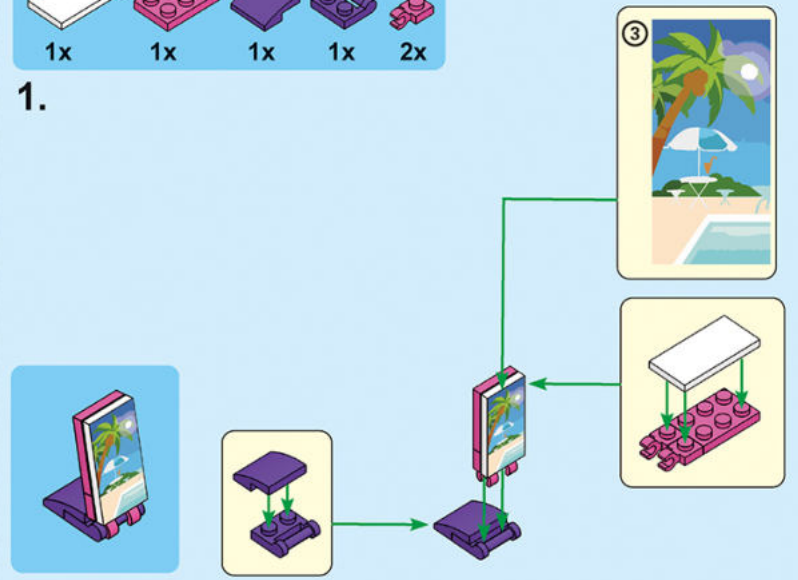





1.

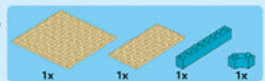

2.



18.



19.



20.



3.

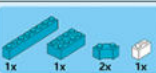

4.



5.

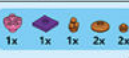

6.



3



22.



23.

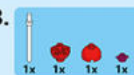

7.



8.



9.



10.



24.

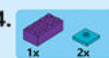

25.



26.



11.



12.

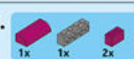

13.



14.



15.



16.



17.



27.

