

- 5x 1x

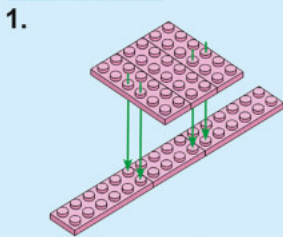

- 1x 4x 6x

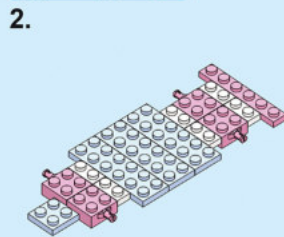

- 1x 3x 1x 4x 2x

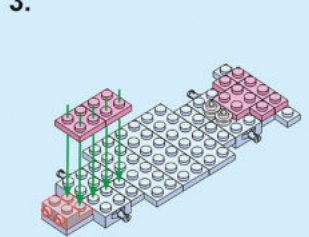

- 1x 1x 2x 4x 6x

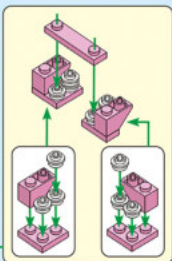
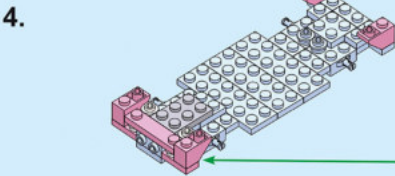

- 1x 1x 2x 8x

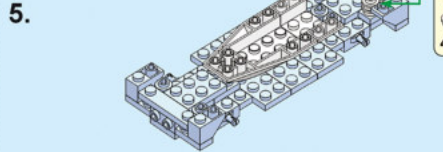

- 4x 2x 2x 2x 1x 1x

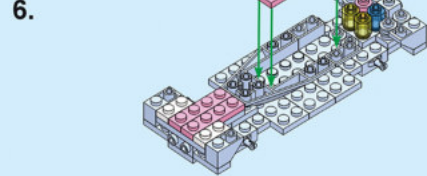

- 4x 6x 4x 2x

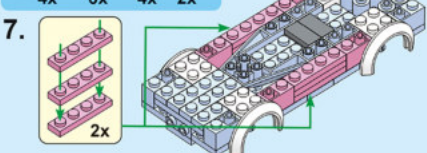

- 4x 2x 1x 1x 14x

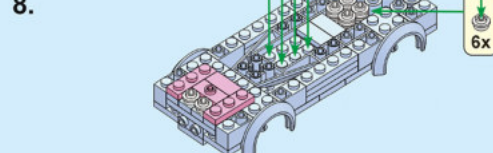

- 2x 1x 2x 2x 2x

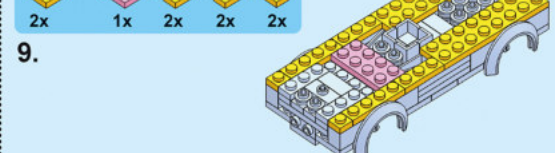

- 1x 2x 2x 2x 2x 2x 1x 1x 2x 4x 2x 2x

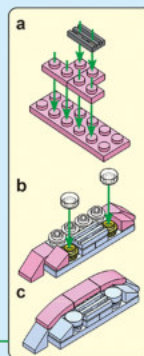
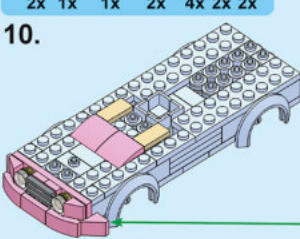

- 1x 2x 2x 2x 6x 2x

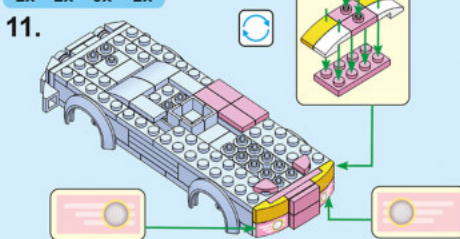

- 1x 2x 2x 1x 2x 4x

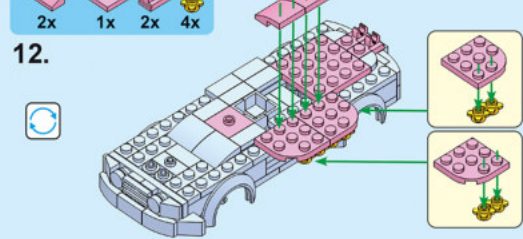

- 2x 2x 2x 4x 1x 6x 2x 1x 1x 2x

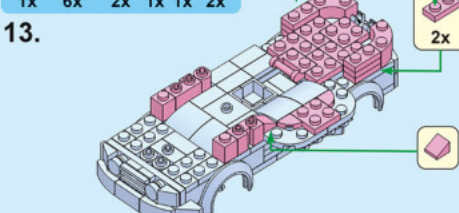

- 1x 1x 2x 2x 2x 2x 1x 1x 1x



- 4x 2x 2x 2x 2x 1x 1x

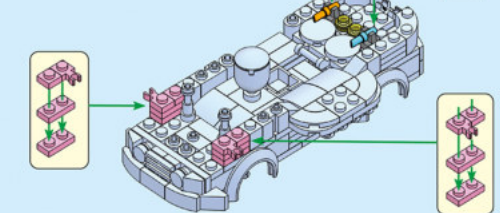

- 1x 5x 1x 2x 1x 2x 2x 1x 2x 1x 2x 2x 2x 2x

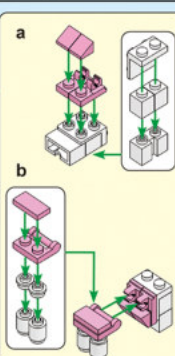
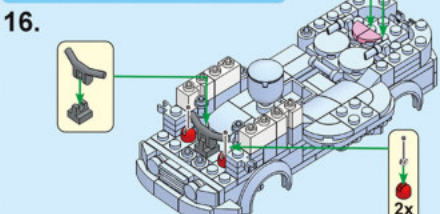

- 1x 4x 1x 1x 1x 8x

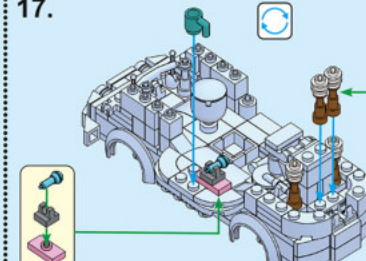

- 1x 2x 1x 2x 8x

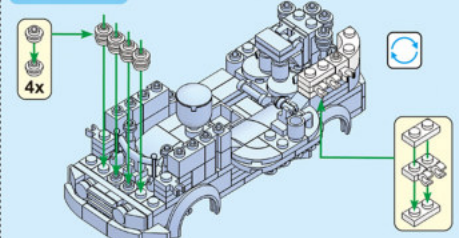

- 2x 2x 1x 1x 2x 2x 2x 1x 1x 2x

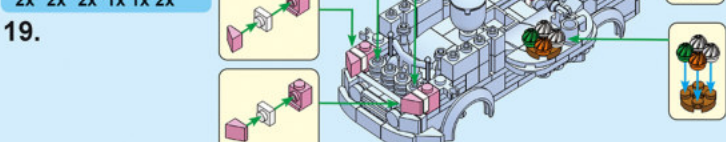

- 1x 1x 2x 1x 1x 2x 1x 2x 2x



- 2x 2x 4x 2x 1x 3x

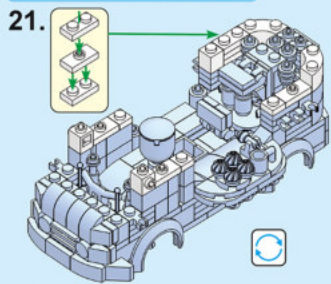

- 1x 1x 1x 1x 2x

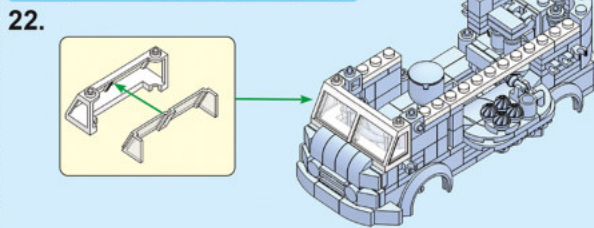

- 3x 2x 3x 6x

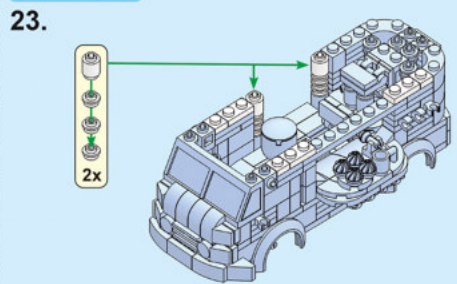

- 1x 2x 2x 4x 2x 2x

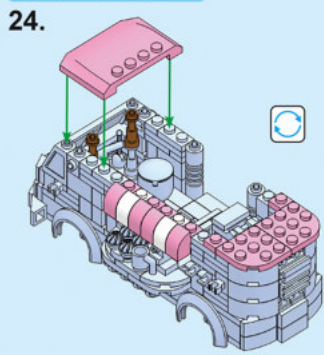

- 2x 2x 2x 1x 1x 1x 2x 2x

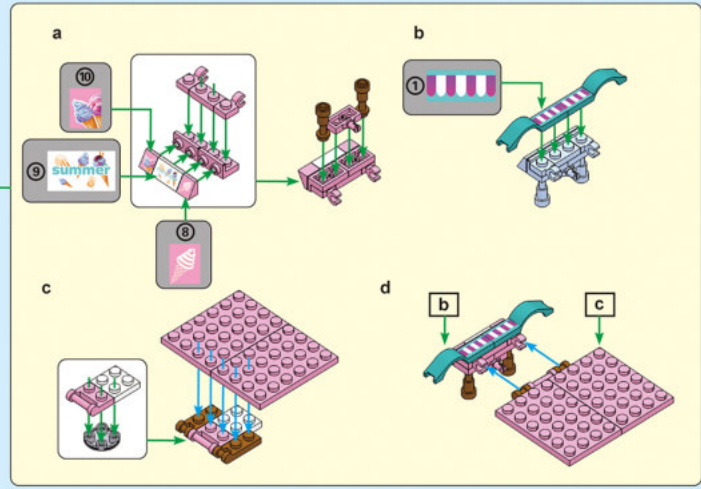
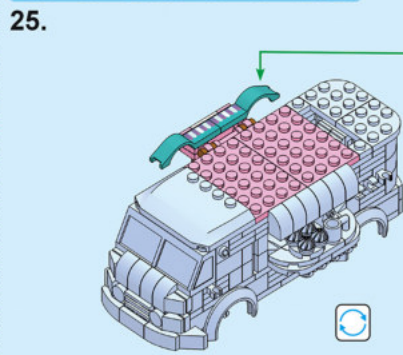

- 2x 1x 1x 2x 2x 3x 2x 1x 8x 2x

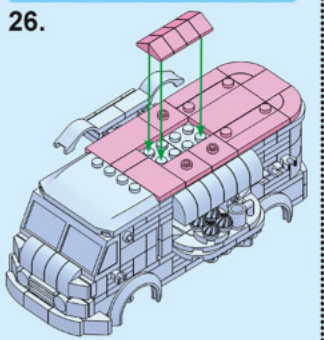

- 1x 1x 4x 2x 2x

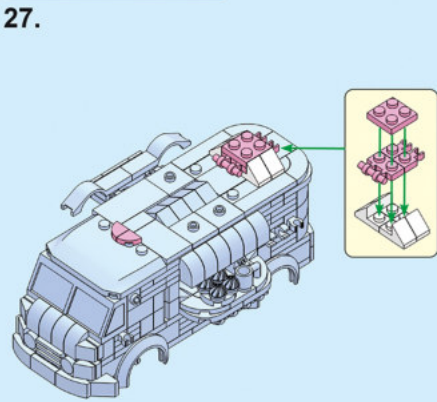

- 2x 2x 2x 2x 2x 2x 2x 4x 2x 2x

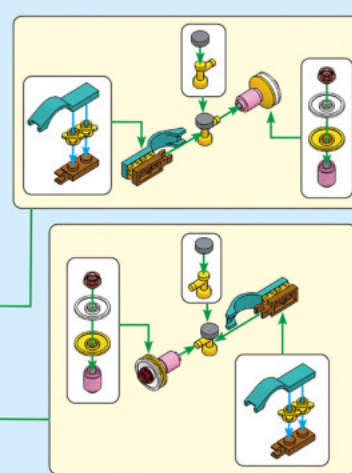
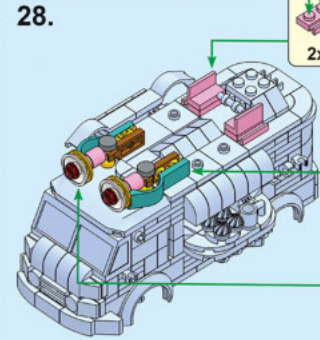

- 1x 2x 2x 2x 4x 1x 1x 10x

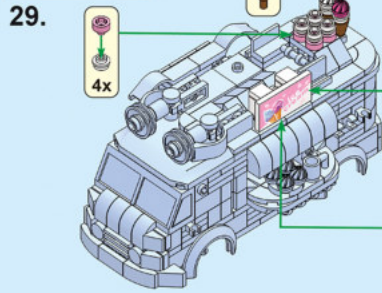

- 1x 1x 1x 1x 1x 1x 1x 1x 1x

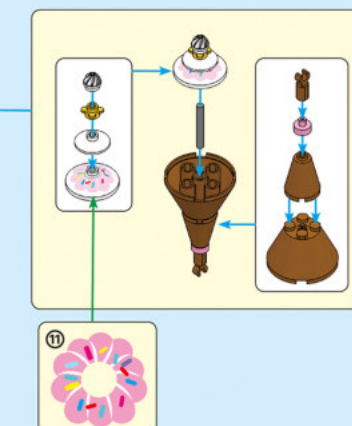
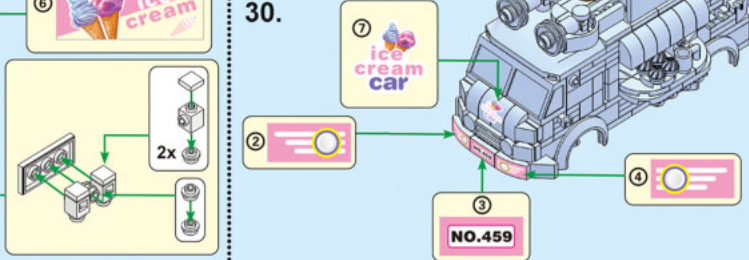

- 1x 1x 1x 1x 1x 2x 2x 1x 3x 1x 1x 1x 1x

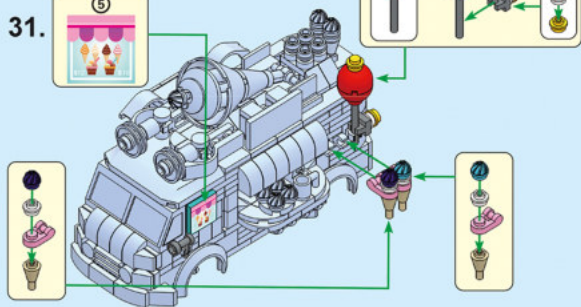

- 1x 1x 1x 1x 1x 1x 1x 1x 1x 1x

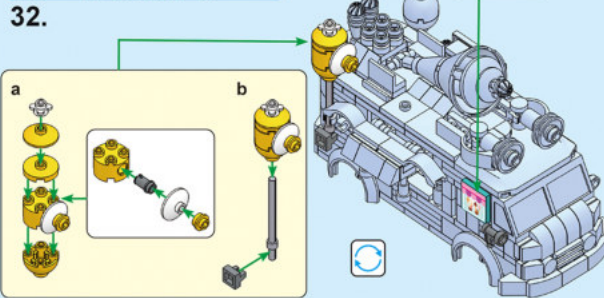

- 4x 4x 3x

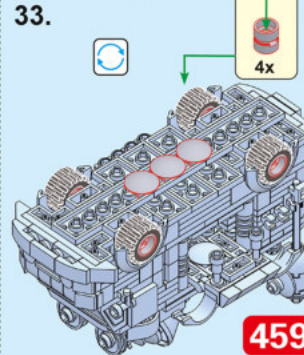

459-1



4x 2x

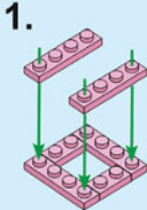

1x 1x 4x 2x 4x

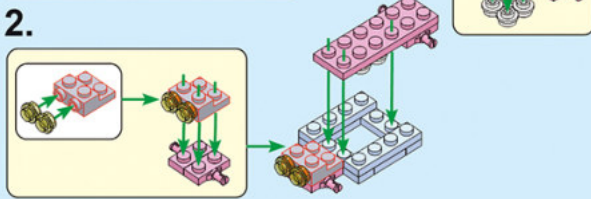

1x 1x 2x 1x 2x

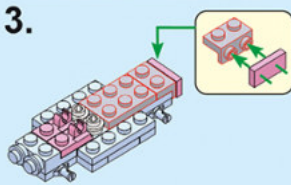

4x 2x 2x

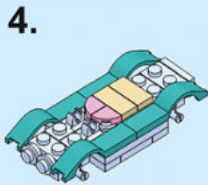

2x 1x 2x 1x 2x

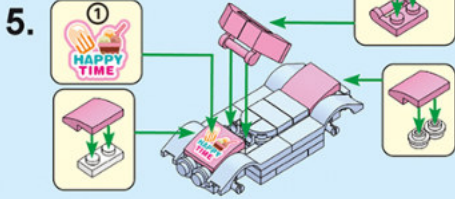

2x 4x

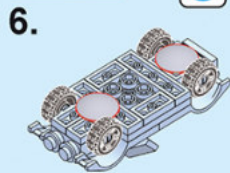

459-1

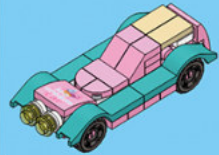

1x 2x 2x

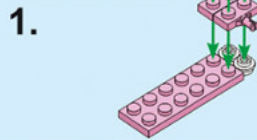

4x 2x

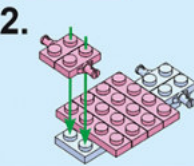

1x 1x 1x 1x 2x 2x

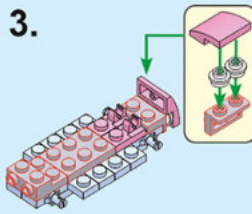

4x 1x 1x 2x 2x

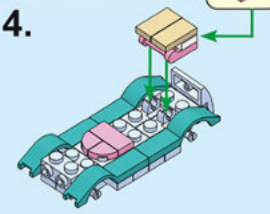

1x 2x 2x 2x 2x

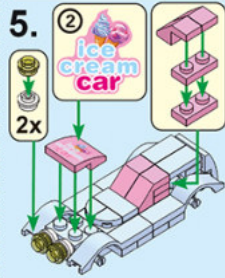

4x

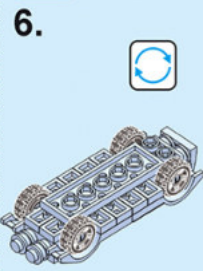

459-2

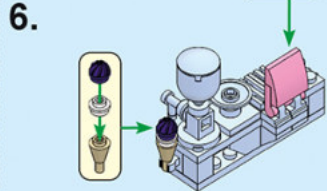
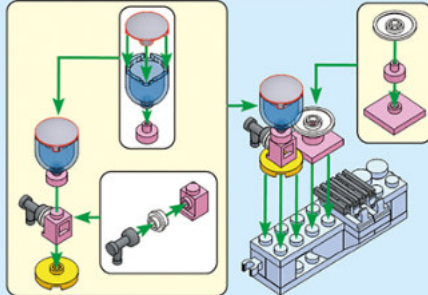
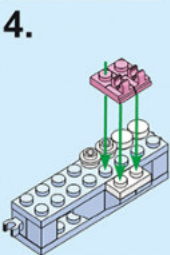
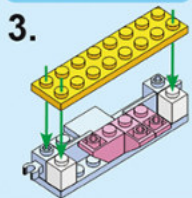
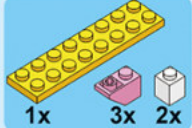
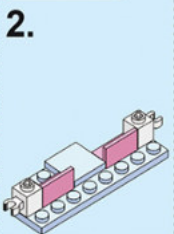
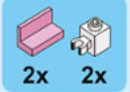
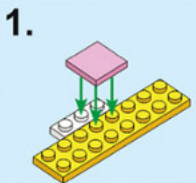
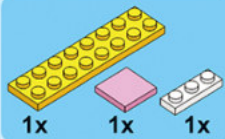
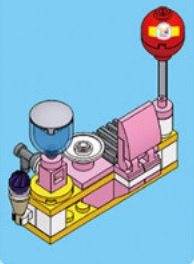

459-2

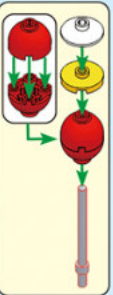
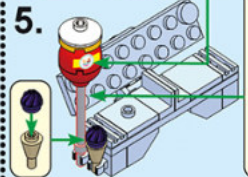
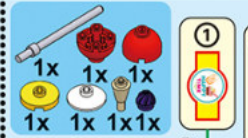
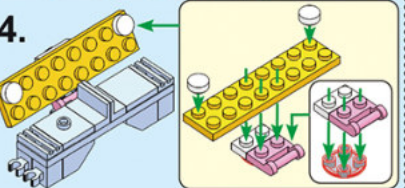
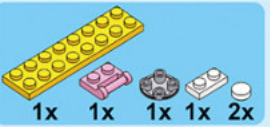
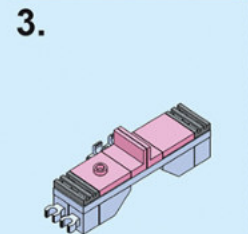
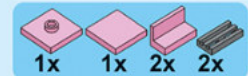
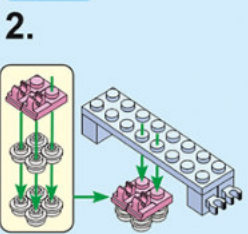
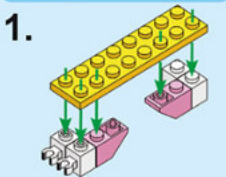
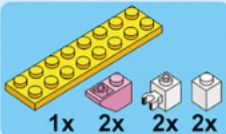
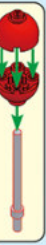
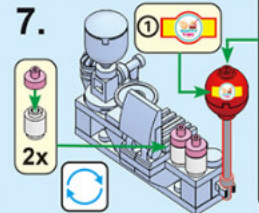
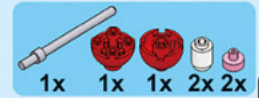

459-3

- 1x 1x 2x 4x

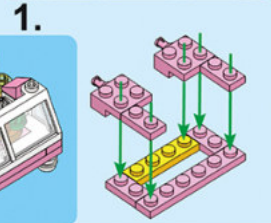

- 1x 1x

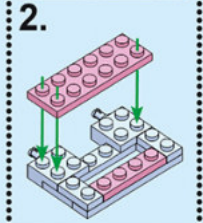

- 1x 1x 2x 1x 1x

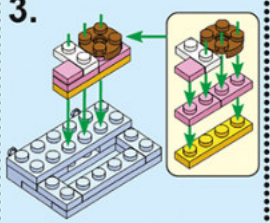

- 2x 1x 1x 1x

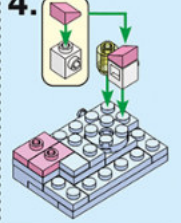

- 1x 2x 2x 1x
- 1x 2x 1x 1x 2x

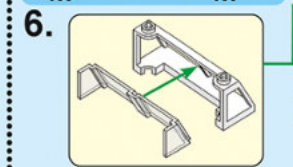
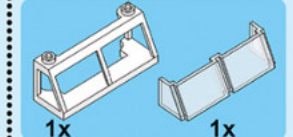
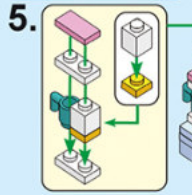

- 8x 4x

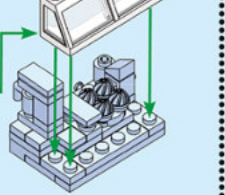

- 1x 2x 2x 1x
- 1x 1x 1x 1x 2x

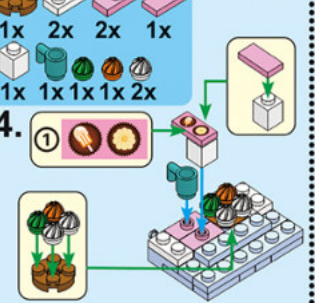
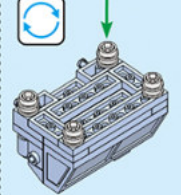

- 1x 1x 10x

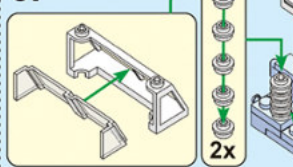

- 1x 1x 1x 1x
- 1x 1x 1x 1x

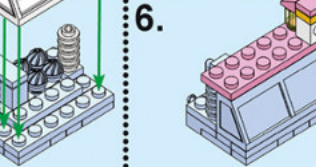

459-3

- 1x 2x 2x

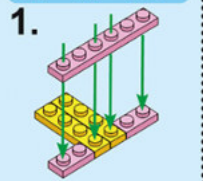

- 2x 1x

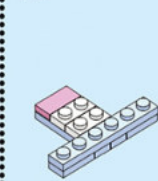

- 1x 2x 4x

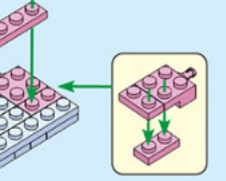
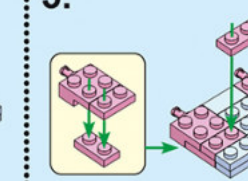

1. **459-4**

1x 2x 1x 4x

1x 2x
1x 2x

1x 2x 1x 1x 1x
2x 2x 2x 2x 1x

2.

3.

4.

1x 1x 1x

5.

1x 1x 1x
1x 1x 2x 2x 3x 1x

2x

4

459-4

1.

1x 1x 2x 4x

1x 1x
2x 2x 2x 2x

2.

3.

1x 1x 2x 1x 1x
1x 2x 2x 2x 2x 2x

4.

2x 1x 1x 2x 1x

5.

3

2

459-5



- 1x [pink 1x4 plate]
- 4x [pink 1x2 plate]
- 1x [blue axle]

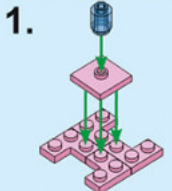

2.

- 4x [white 1x2 brick with hole]
- 4x [white 1x2 brick with hole]

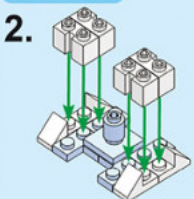

3.

- 4x [white 1x2 brick with hole]
- 2x [pink 1x2 plate]
- 4x [yellow axle]

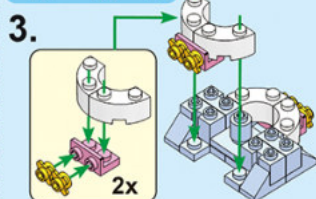

- 1x [white 1x2 brick with hole]
- 1x [white 1x2 brick with hole]
- 1x [white 1x2 brick with hole]
- 1x [pink 1x2 plate]
- 4x [pink 1x2 plate]
- 2x [yellow axle]
- 6x [yellow axle]



5.

- 1x [brown dome]
- 1x [yellow axle]
- 1x [blue hand]
- 4x [white axle]



459-5



- 2x [pink 1x2 plate]
- 2x [white 1x2 brick with hole]
- 2x [pink 1x2 plate]
- 1x [white 1x2 brick with hole]

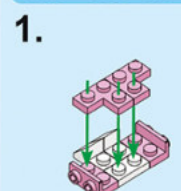

2.

- 2x [pink 1x2 plate]
- 2x [white 1x2 brick with hole]
- 2x [yellow axle]

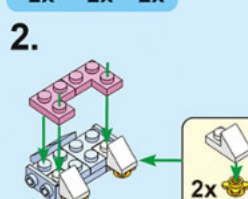

3.

- 1x [white 1x2 brick with hole]
- 2x [white 1x2 brick with hole]
- 4x [yellow axle]

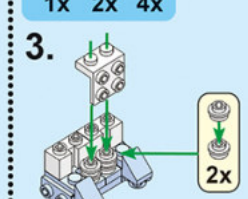

- 2x [white 1x2 brick with hole]
- 1x [white 1x2 brick with hole]
- 1x [pink 1x2 plate]
- 8x [yellow axle]

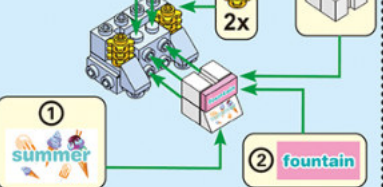

- 4x [white 1x2 brick with hole]
- 4x [pink 1x2 plate]

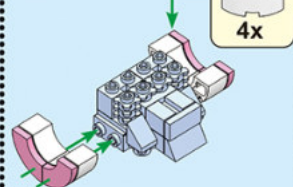

- 1x [pink 1x4 plate]
- 1x [yellow axle]
- 1x [blue hand]
- 1x [blue axle]

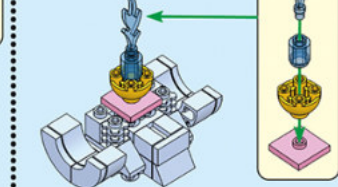

459-6

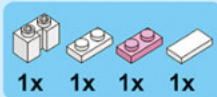
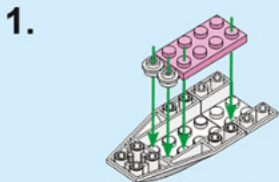
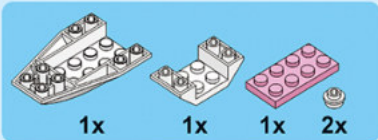

2.

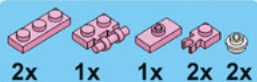
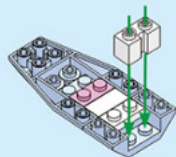

3.

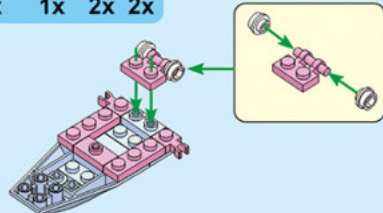

4.

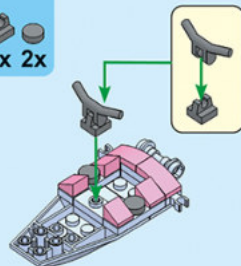

459-6

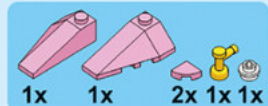

5.

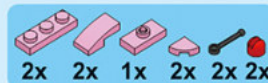
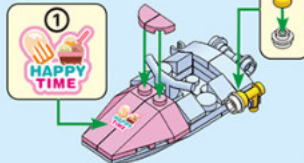

2.

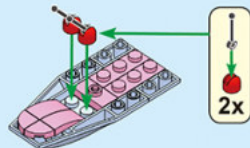

3.

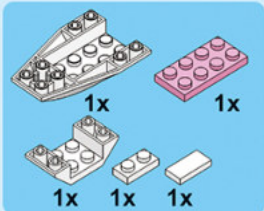
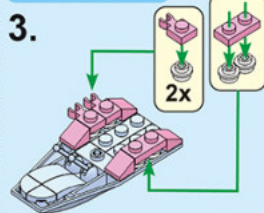

1.

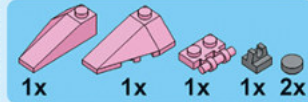
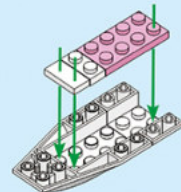

4.

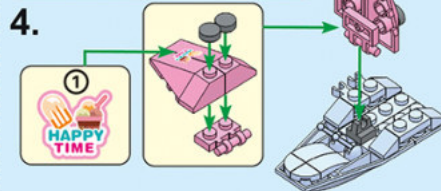

459-7

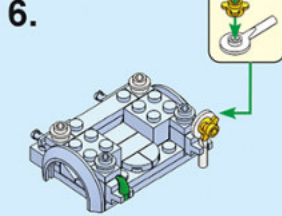
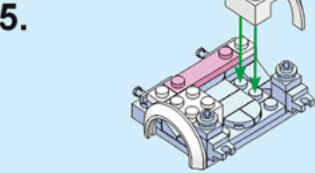
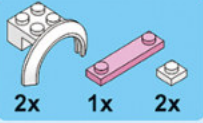
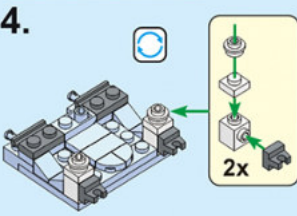
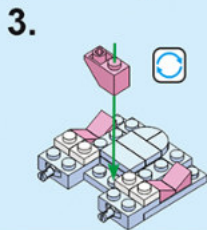
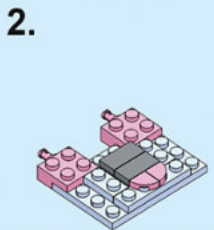
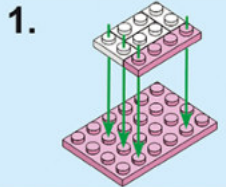
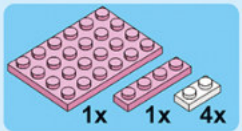

459-7

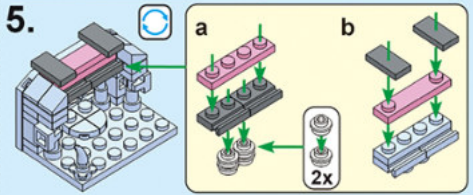
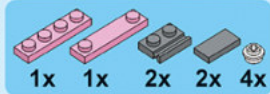
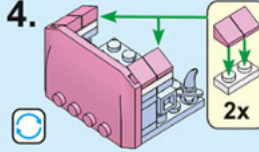
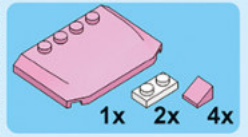
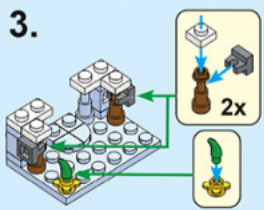
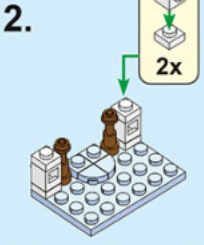
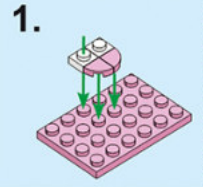
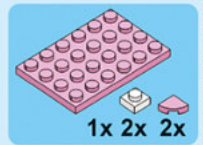
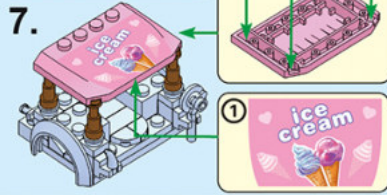
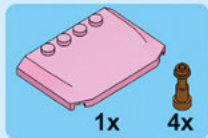

459-8



1.

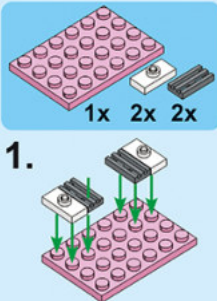

2.

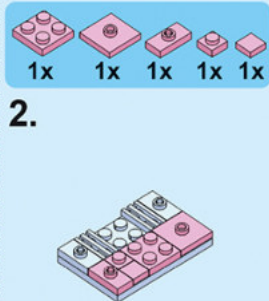

3.

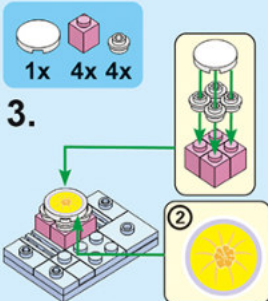

4.

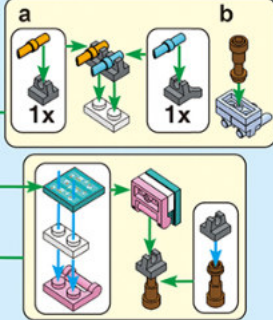
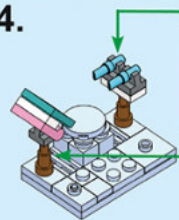

5.

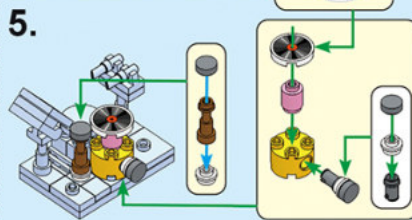

459-8

6.

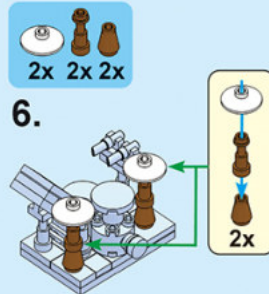

459-8



1.

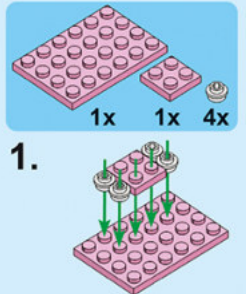

2.

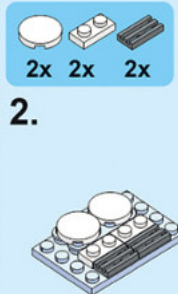

3.

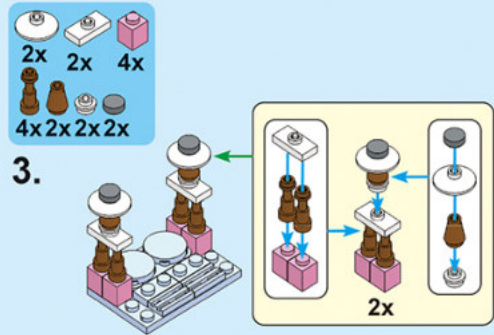

4.

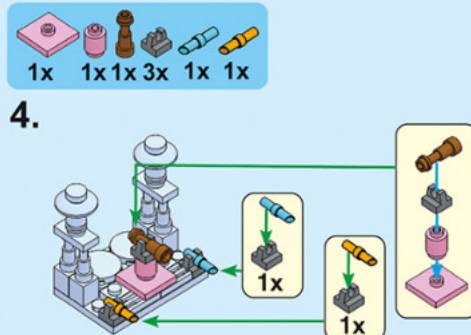

459-9

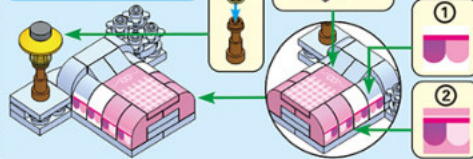
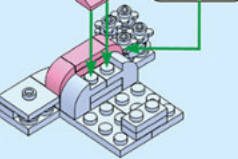
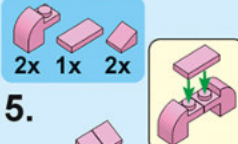
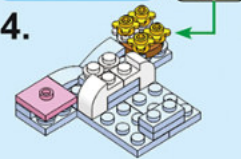
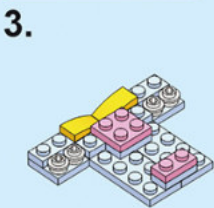
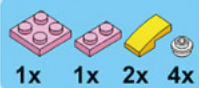
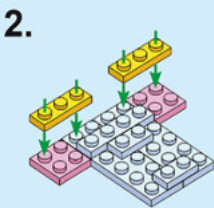
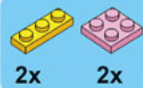
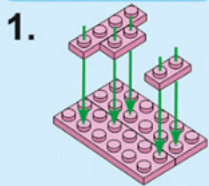
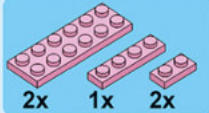

459-9

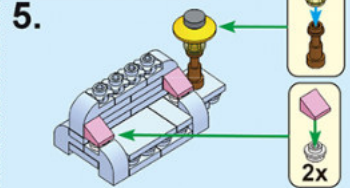
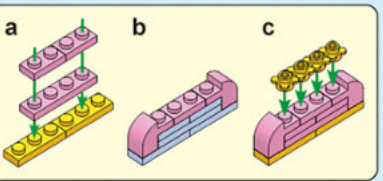
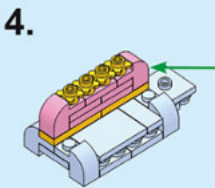
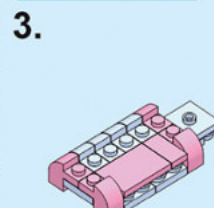
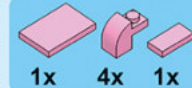
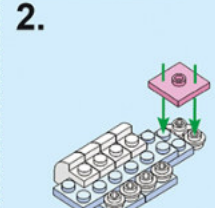
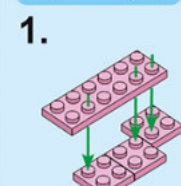
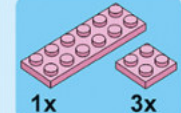

459-10

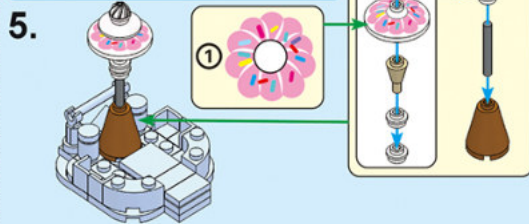
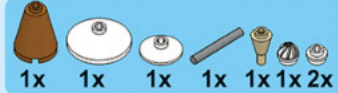
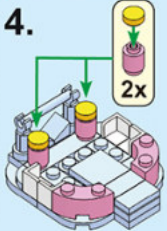
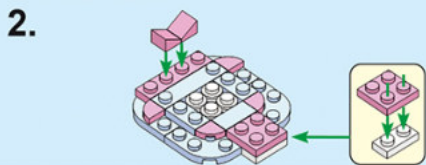
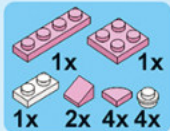
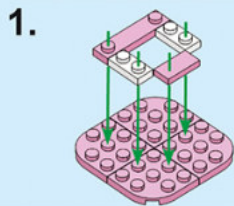
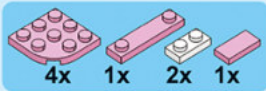

459-10

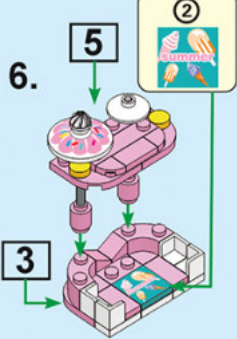
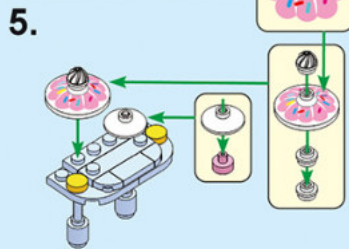
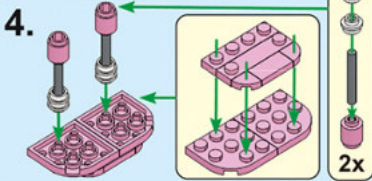
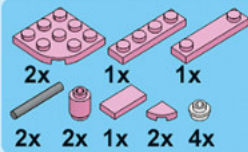
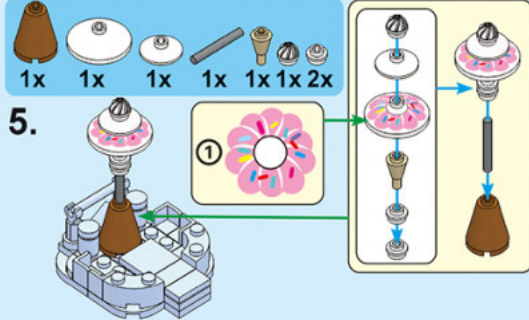
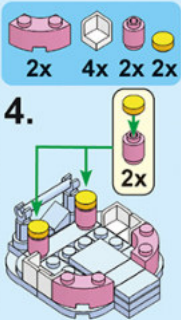
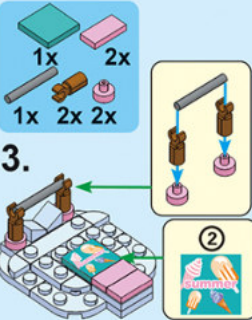
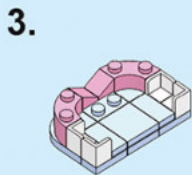
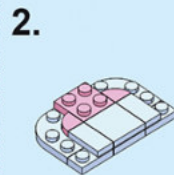
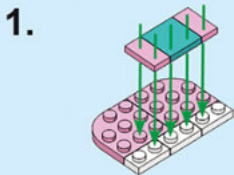
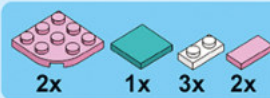

459-11

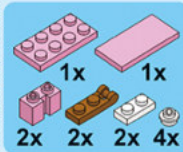
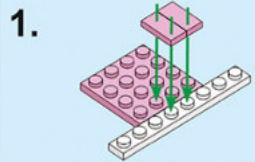
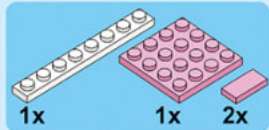

2.

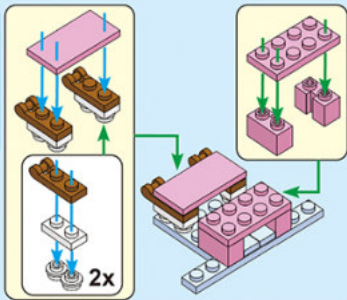

3.

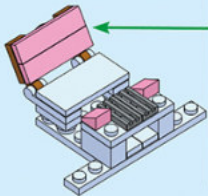

4.

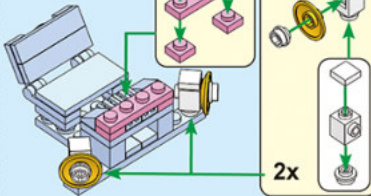

5.

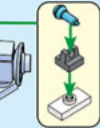
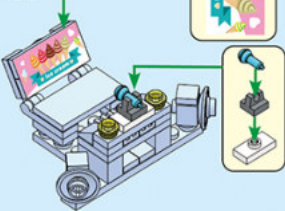

459-11

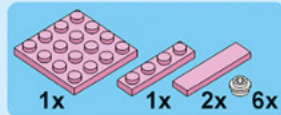
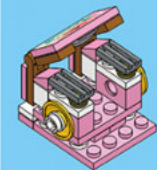

1.

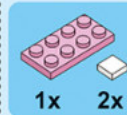
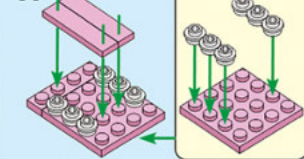

2.

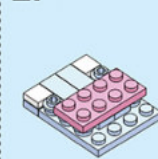

3.

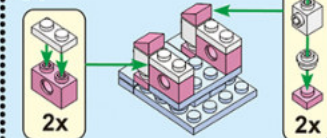

4.

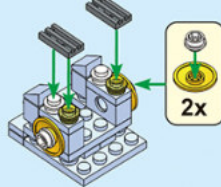

5.

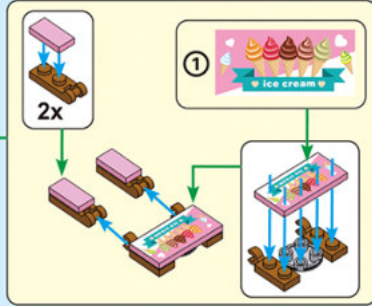
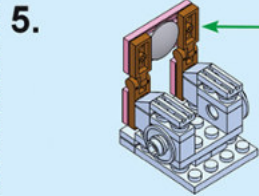

459-12

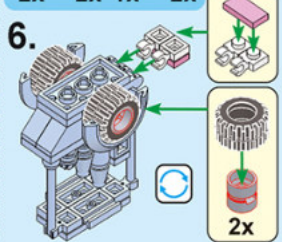
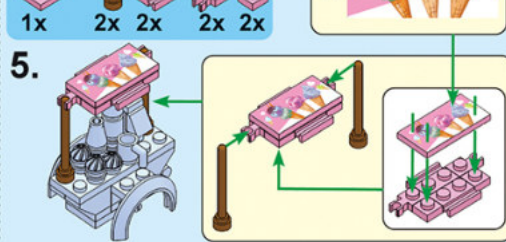
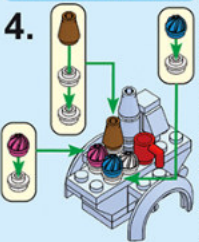
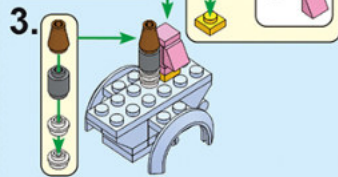
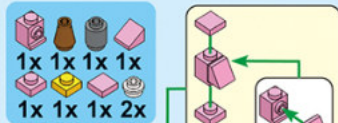
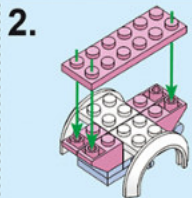
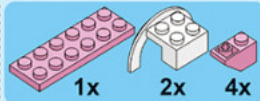
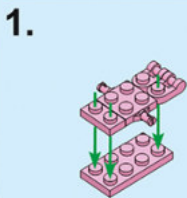
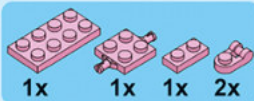

459-12

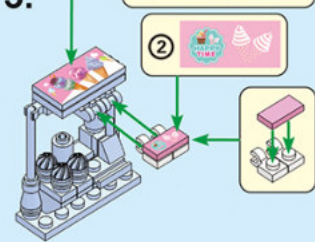
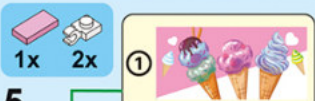
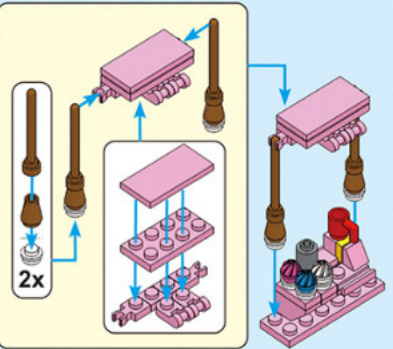
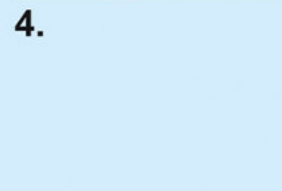
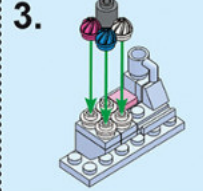
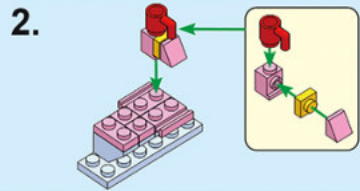
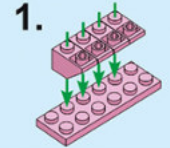
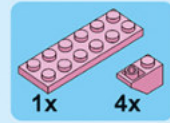

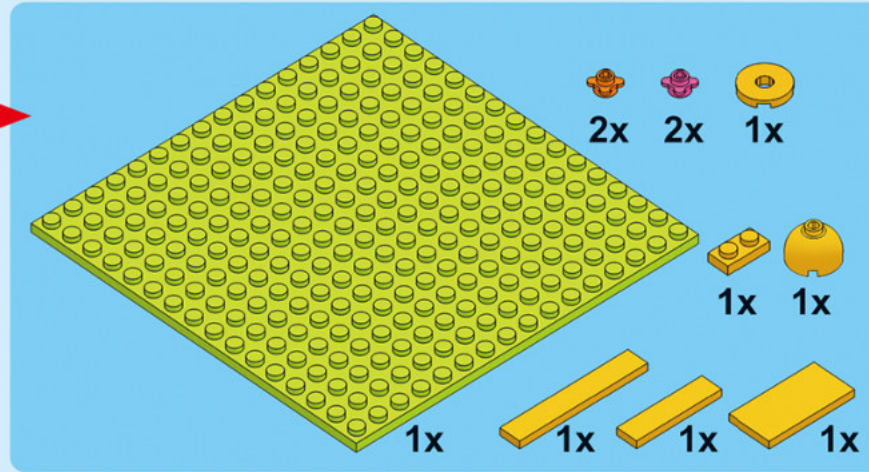

1.

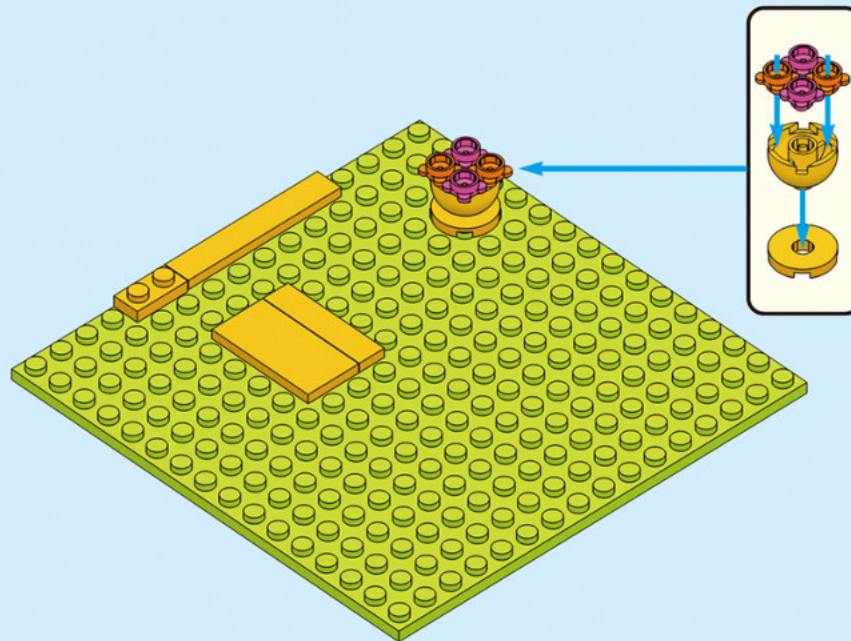

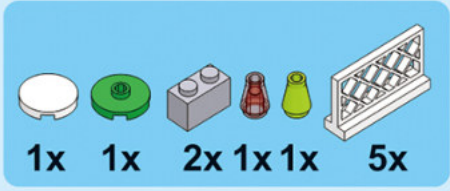

2.

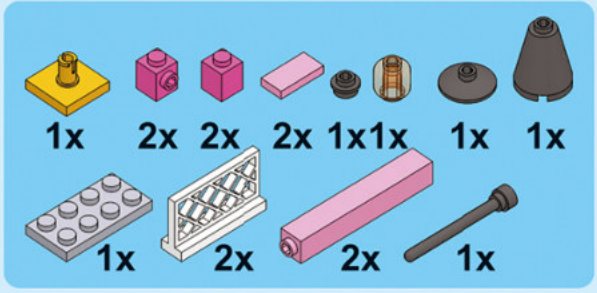
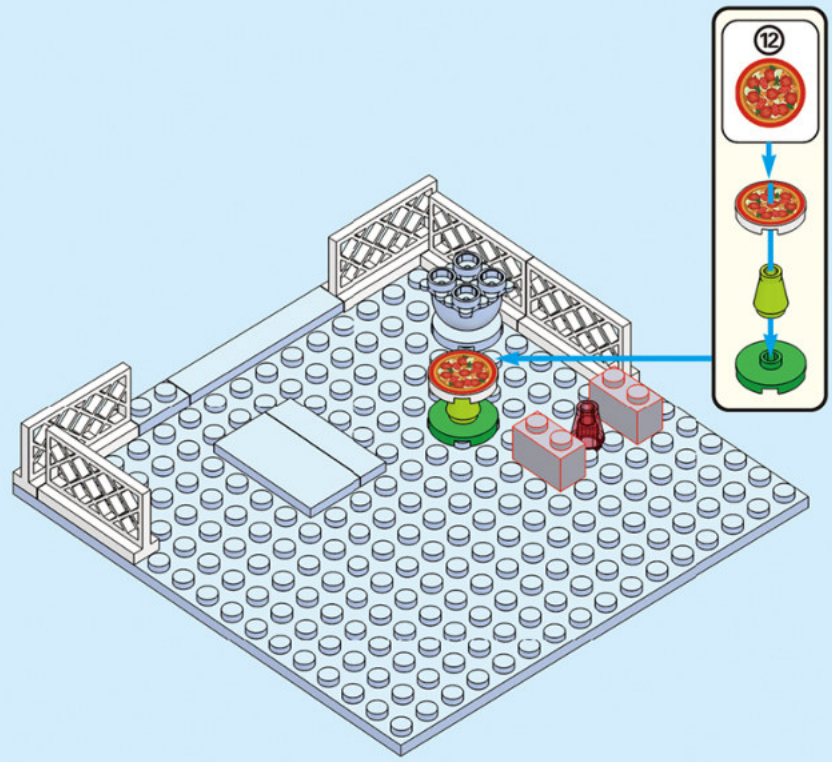

3.

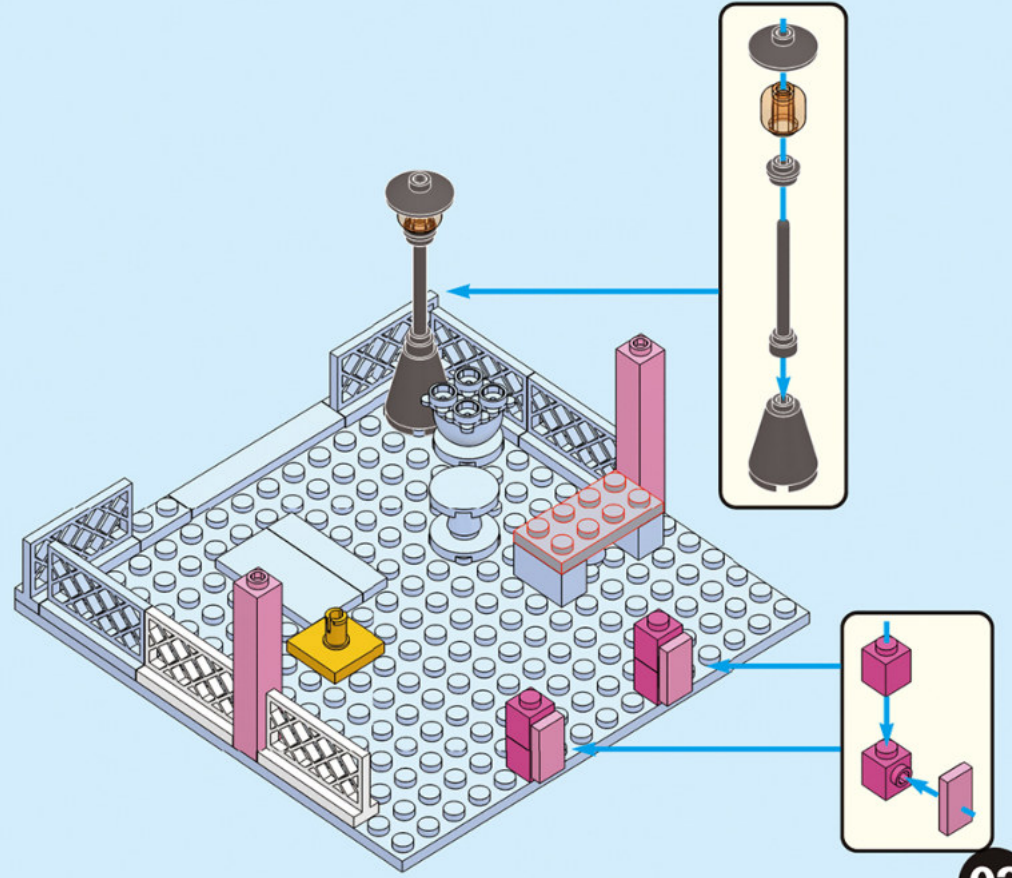

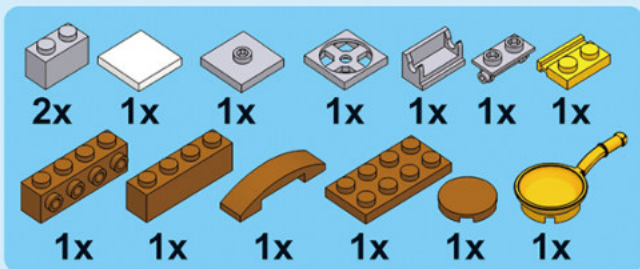

4.

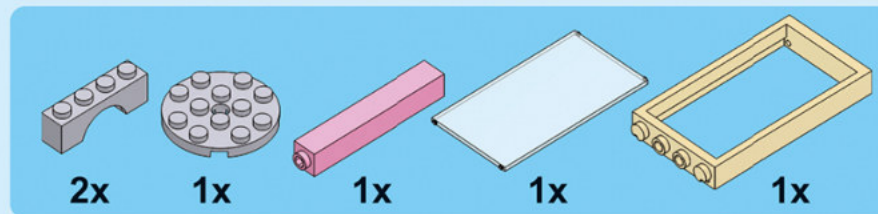
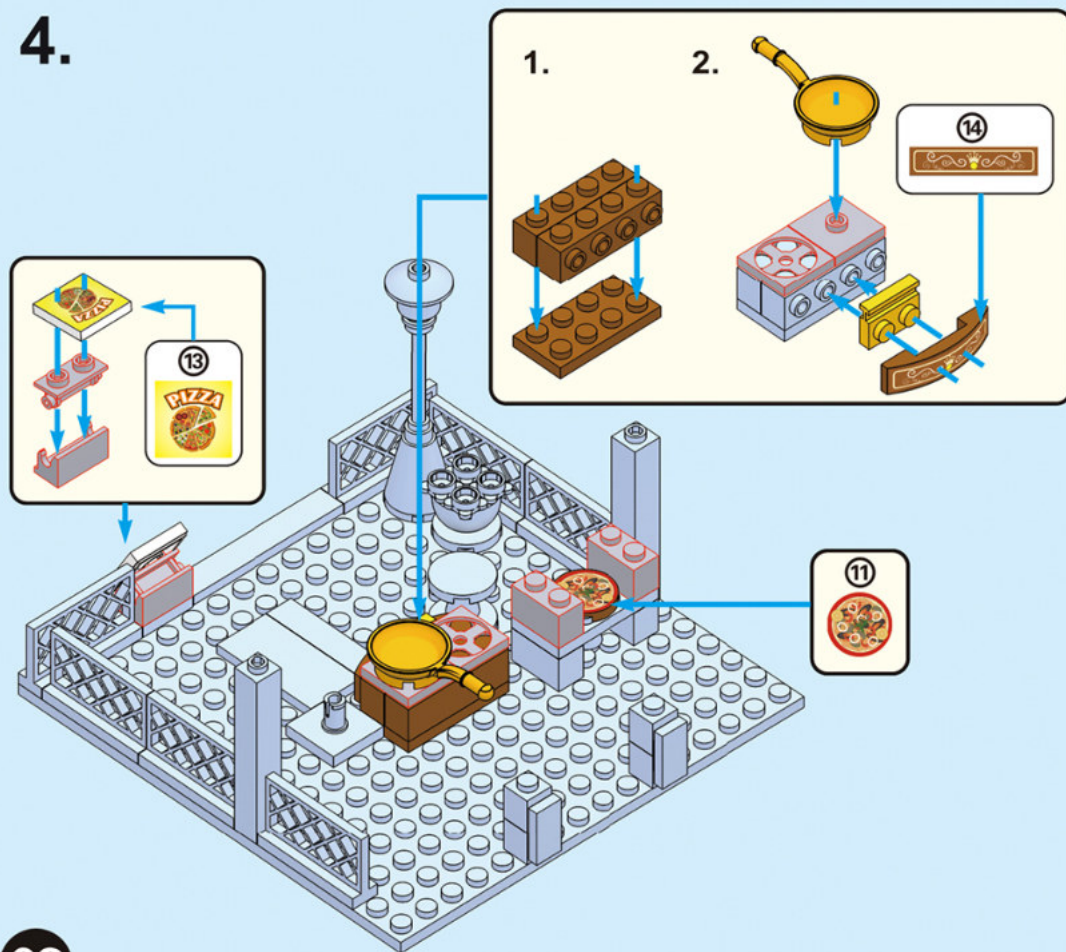

5.

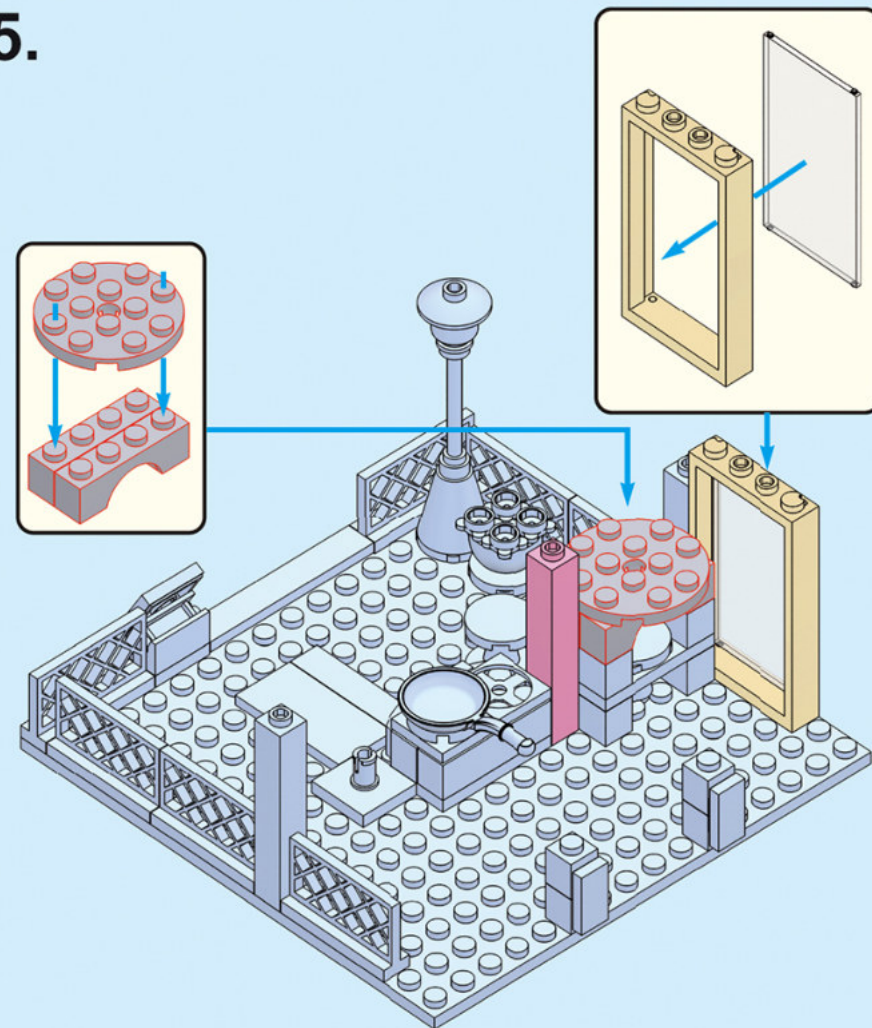

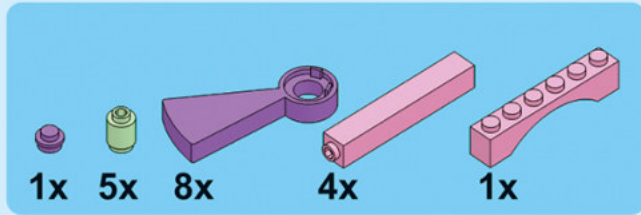

6.

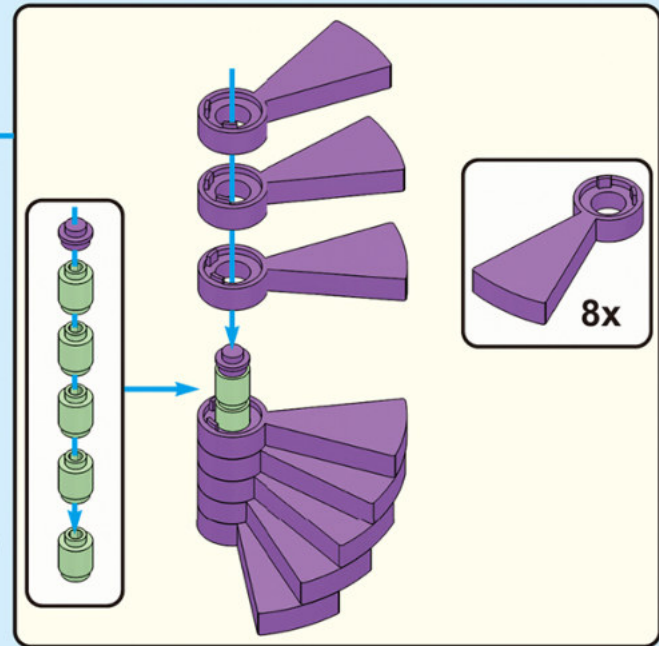
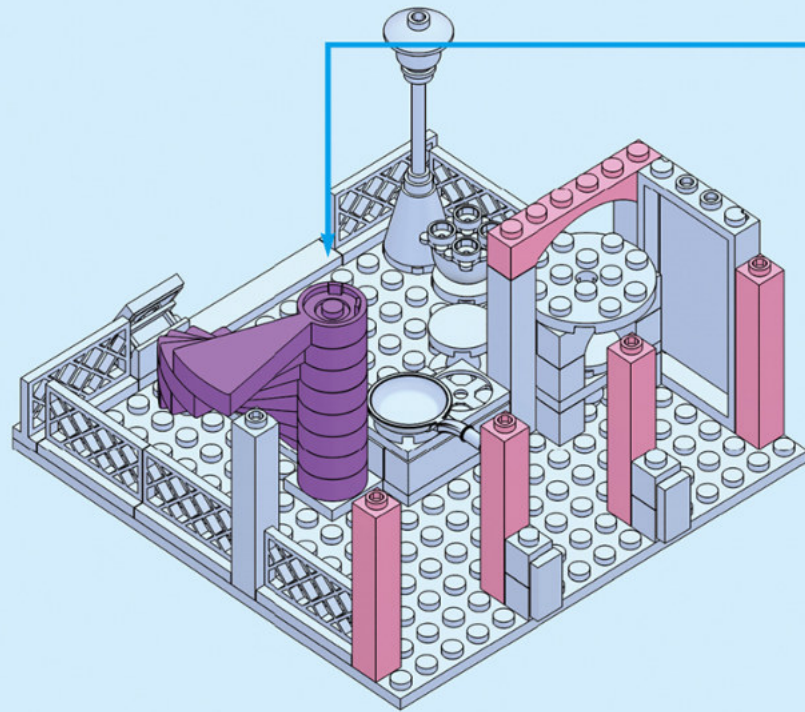

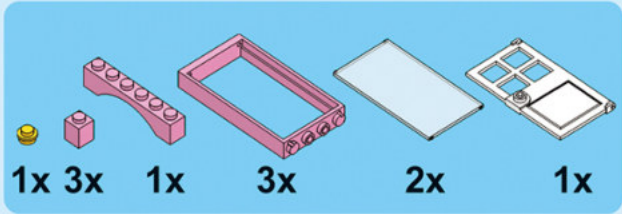

7.

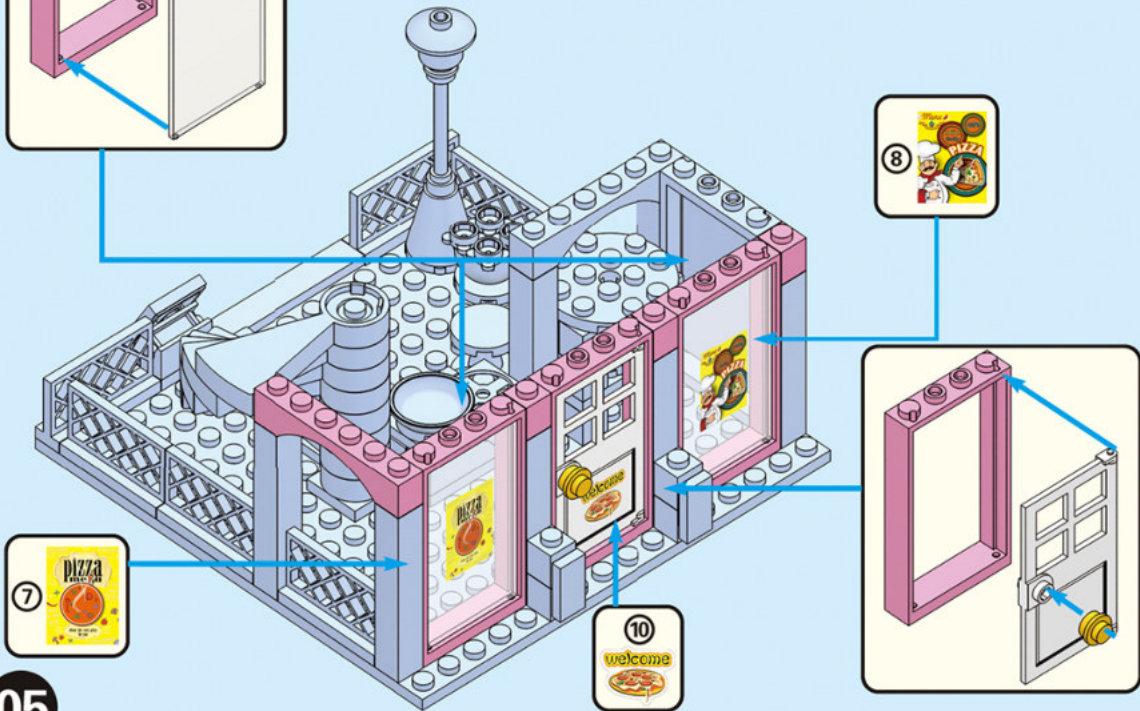
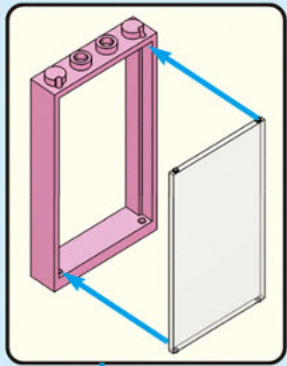

05

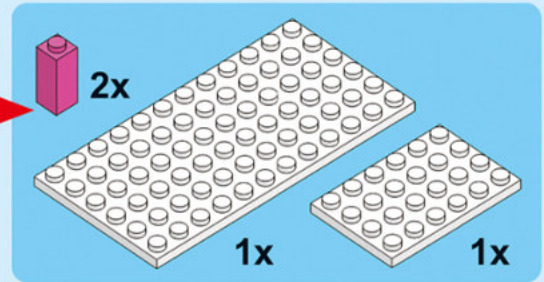

8.

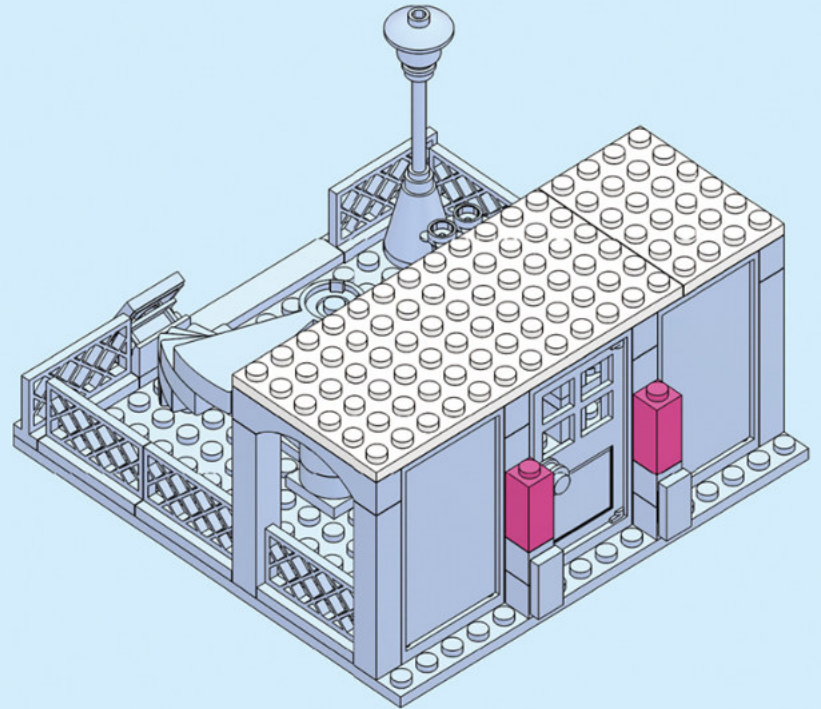

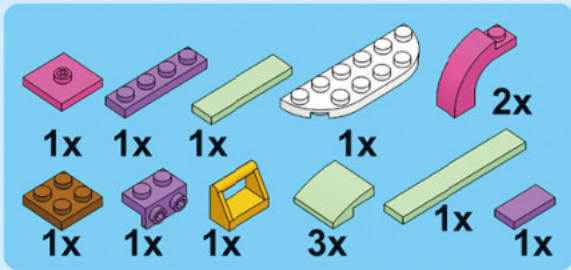

9.

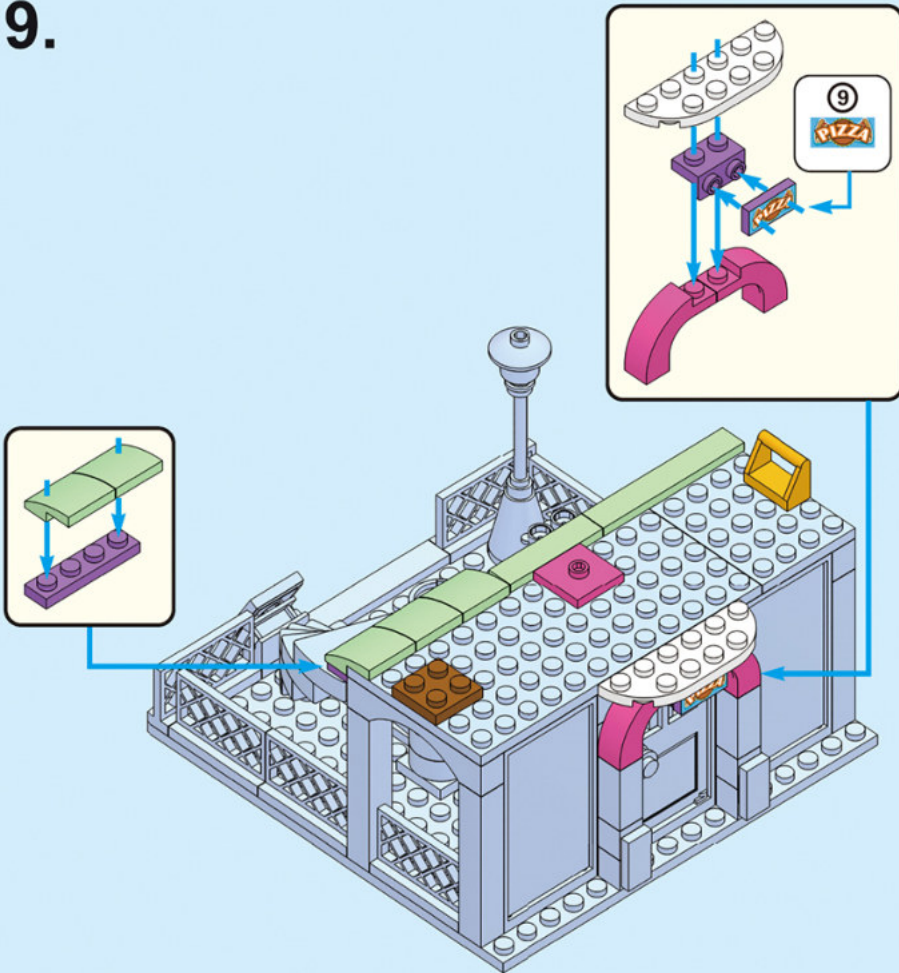

10.

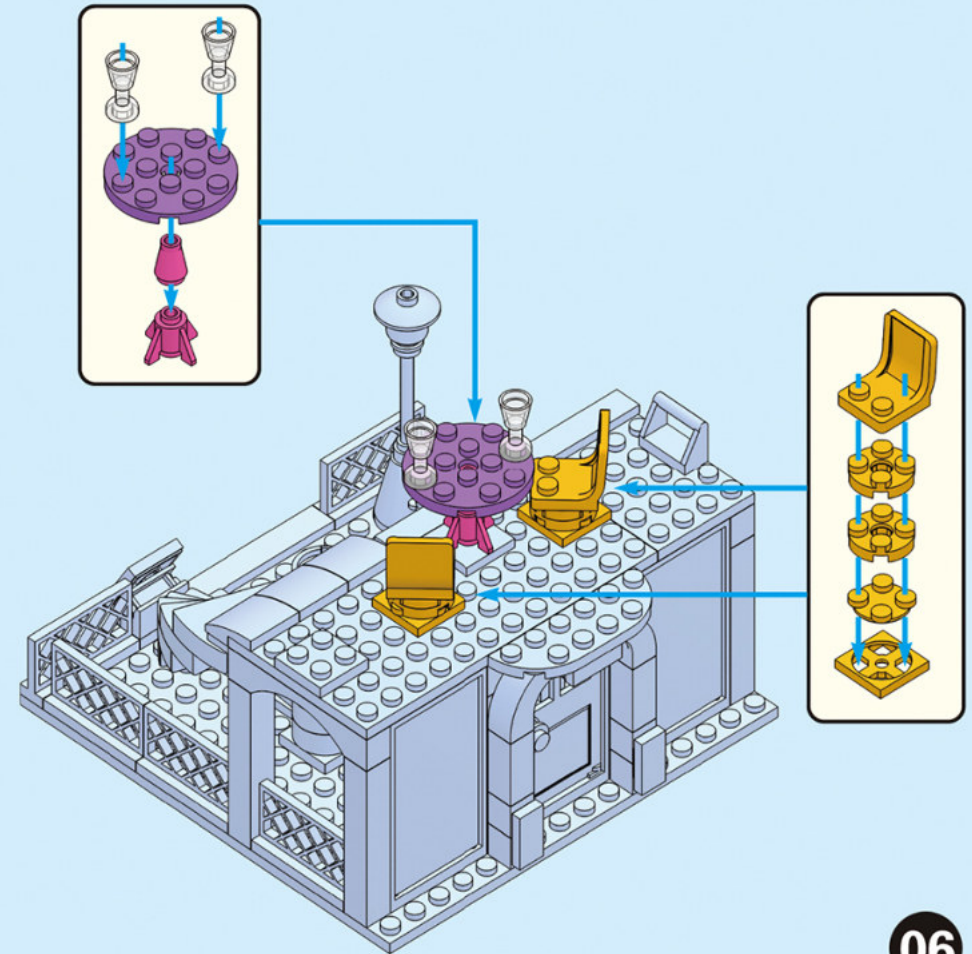

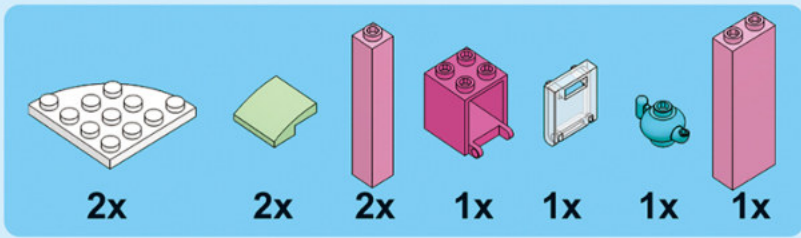

11.

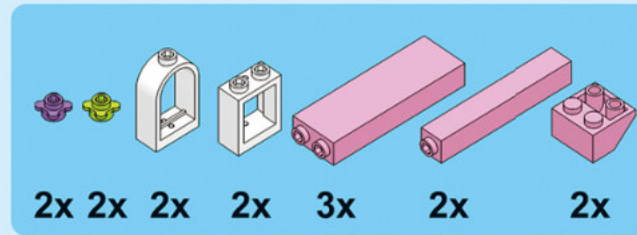
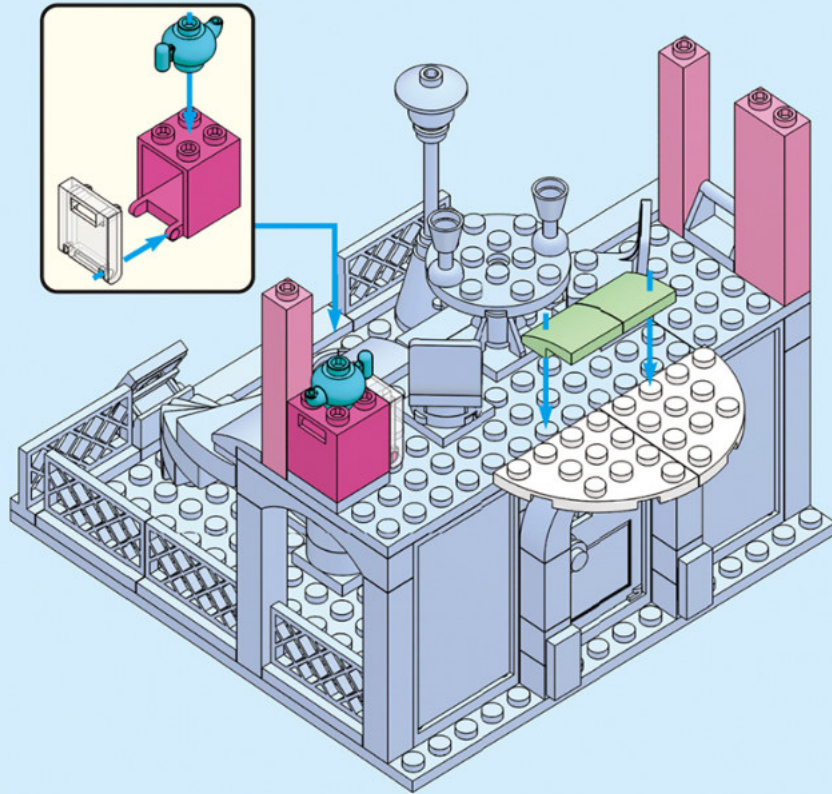

12.

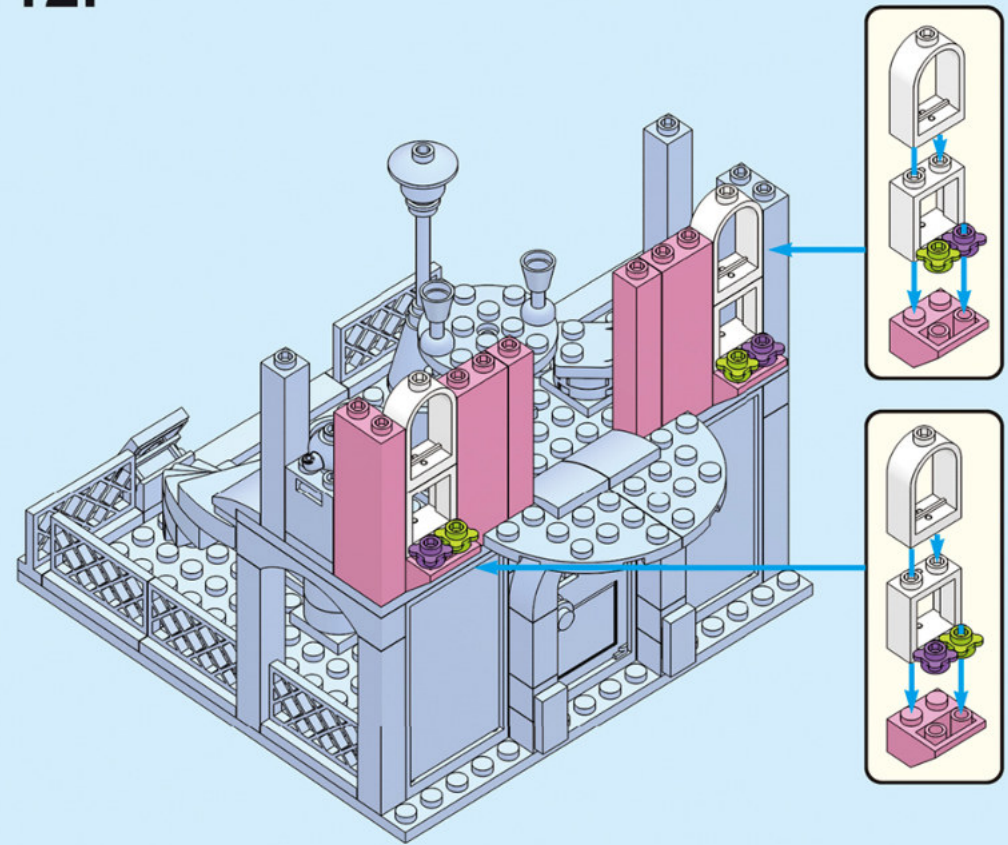

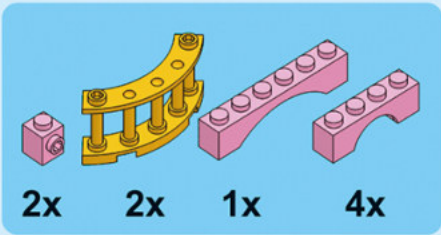

13.

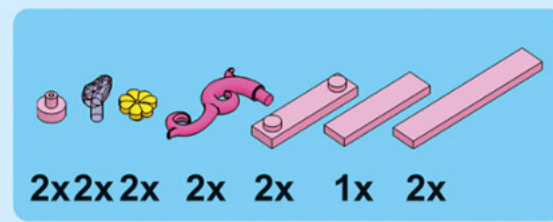
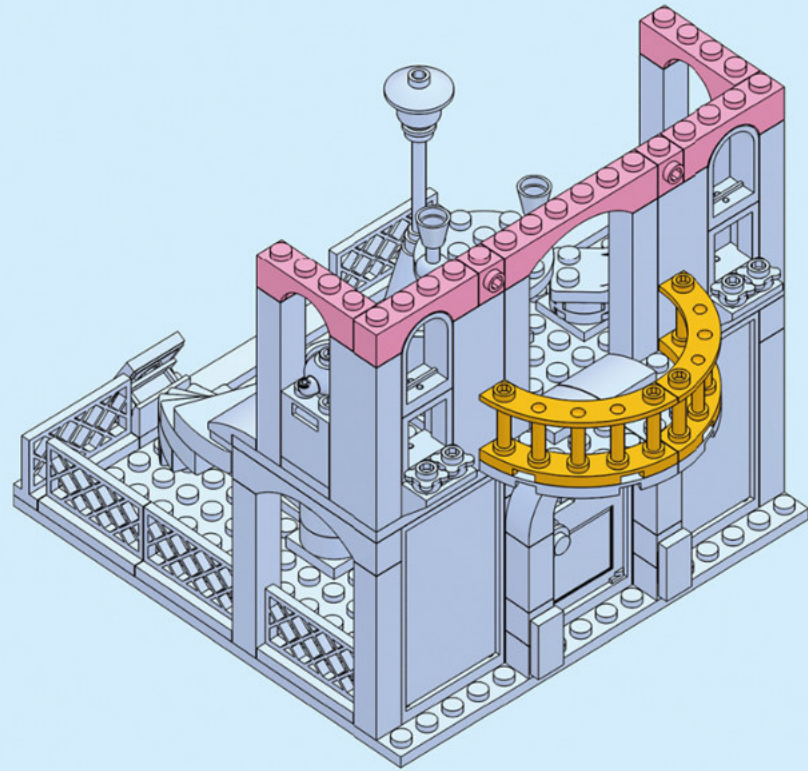

14.

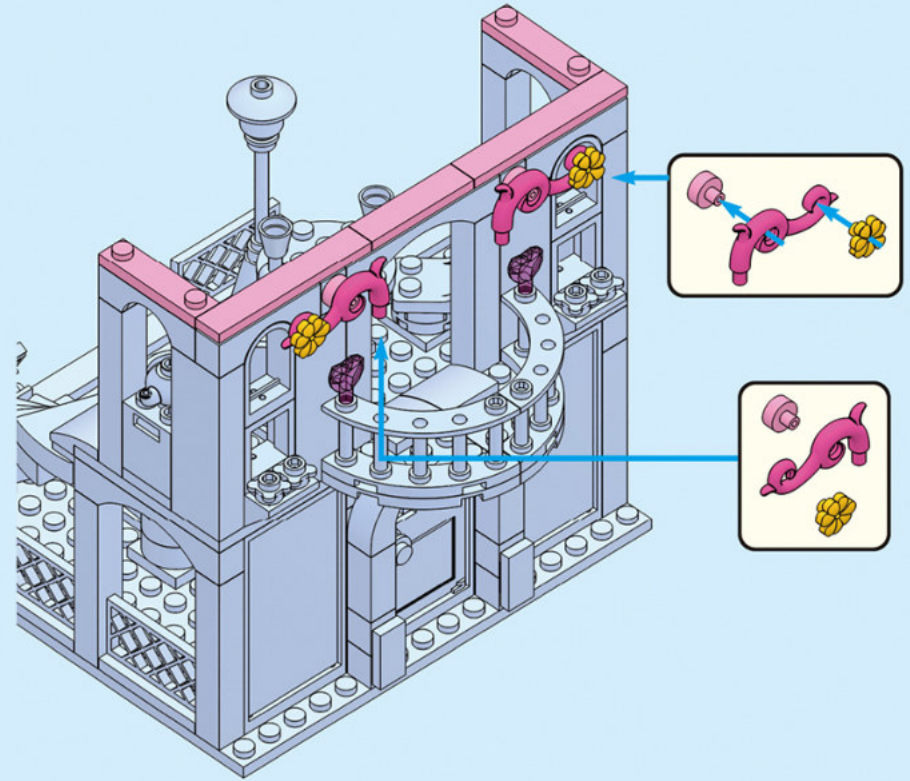

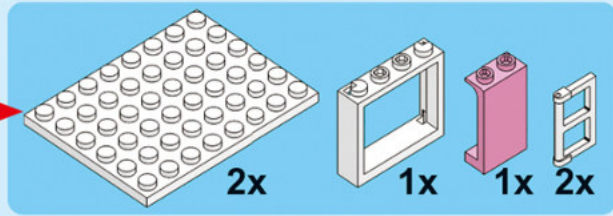

15.

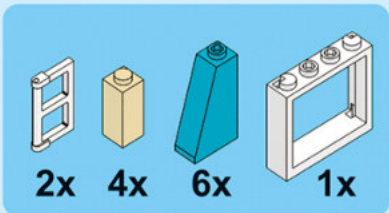
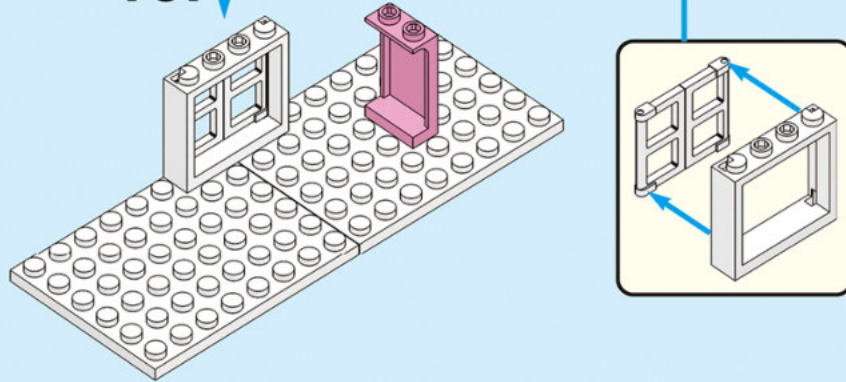

16.

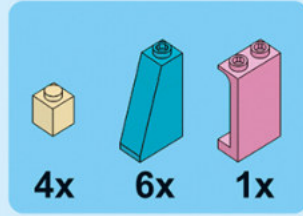
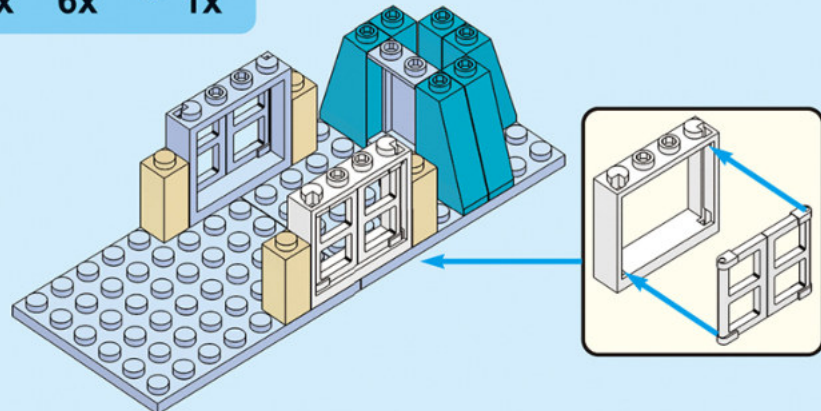

17.

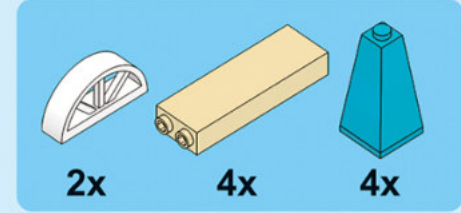
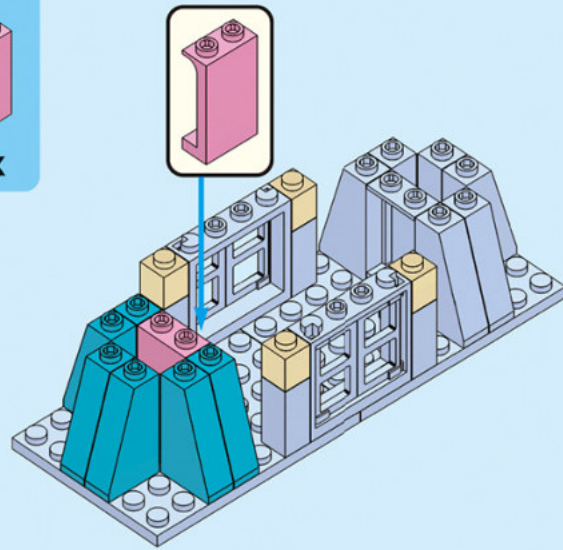

18.

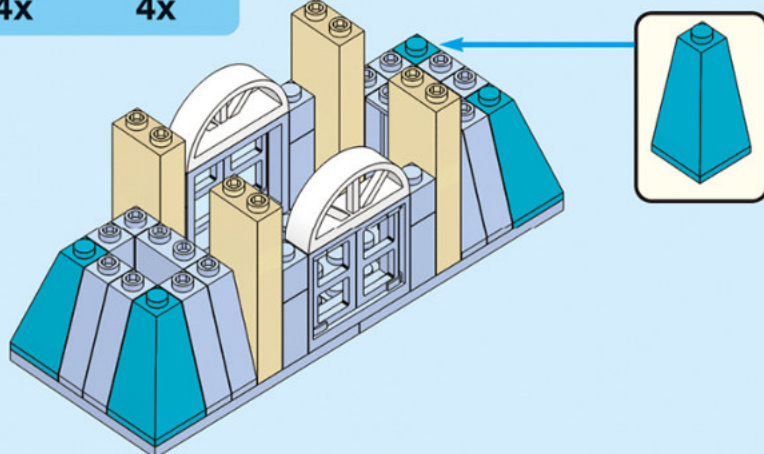

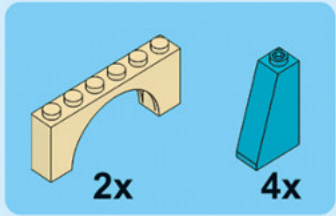

19.

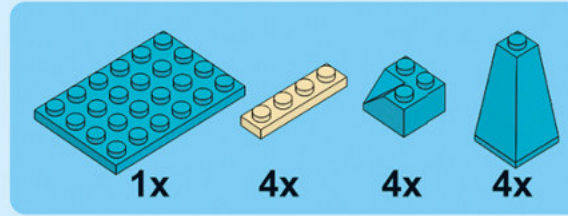
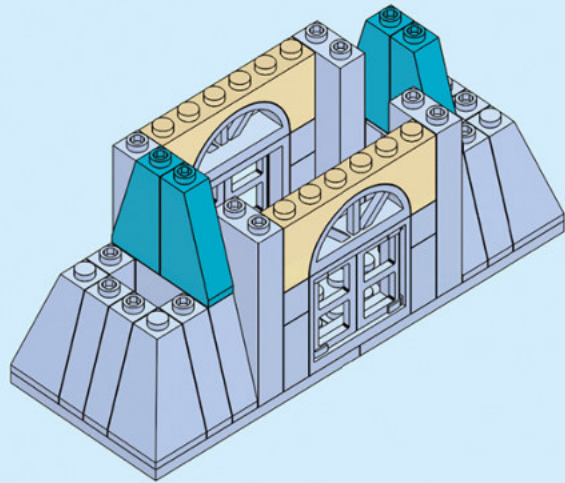

20.

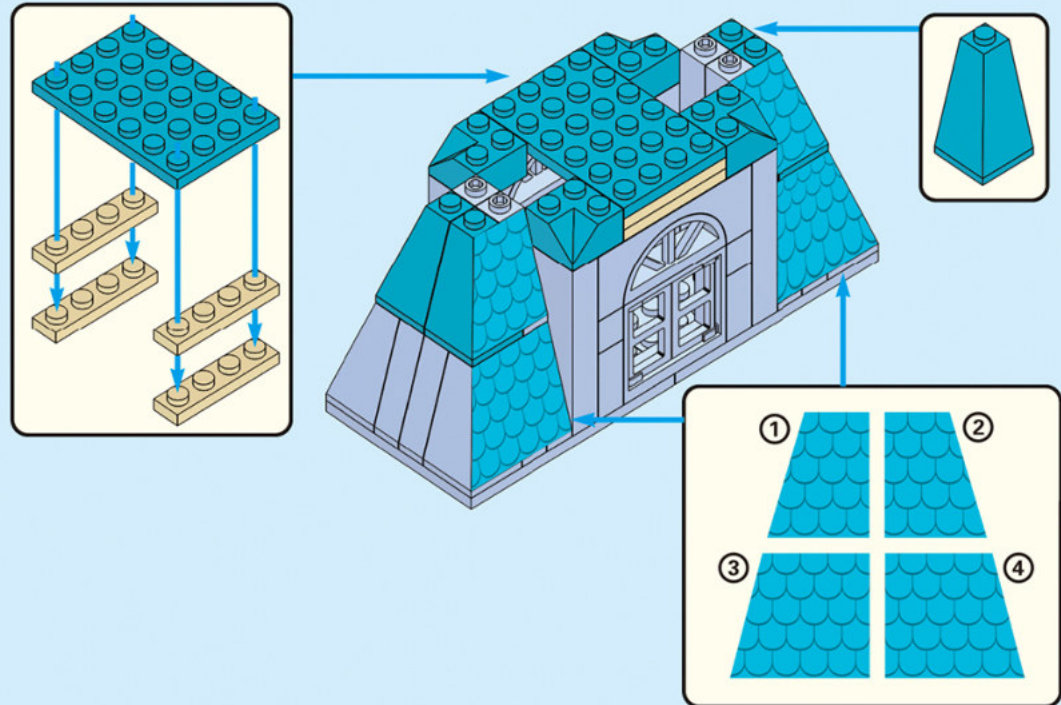

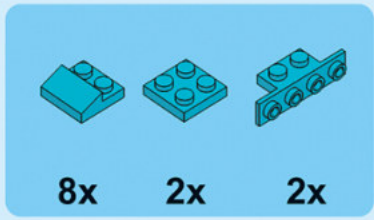

21.

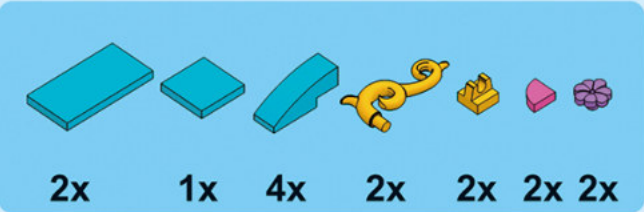
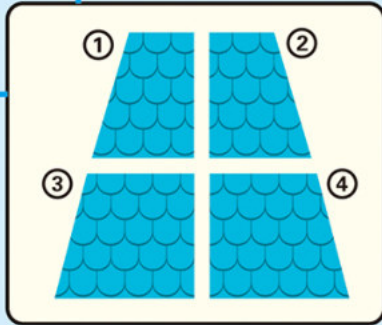
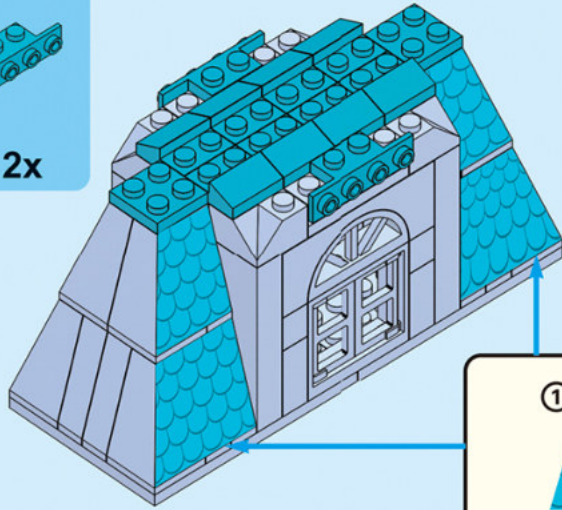

22.

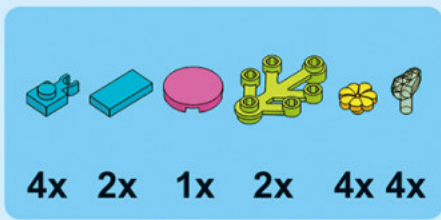
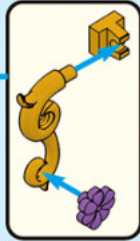
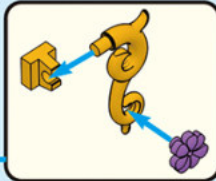
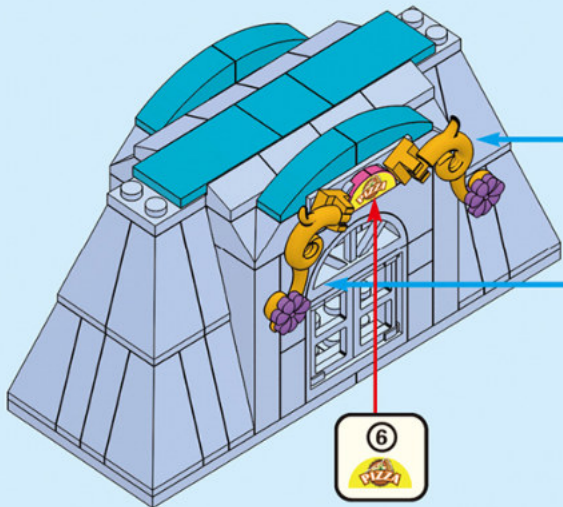

23.

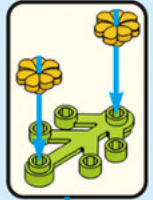
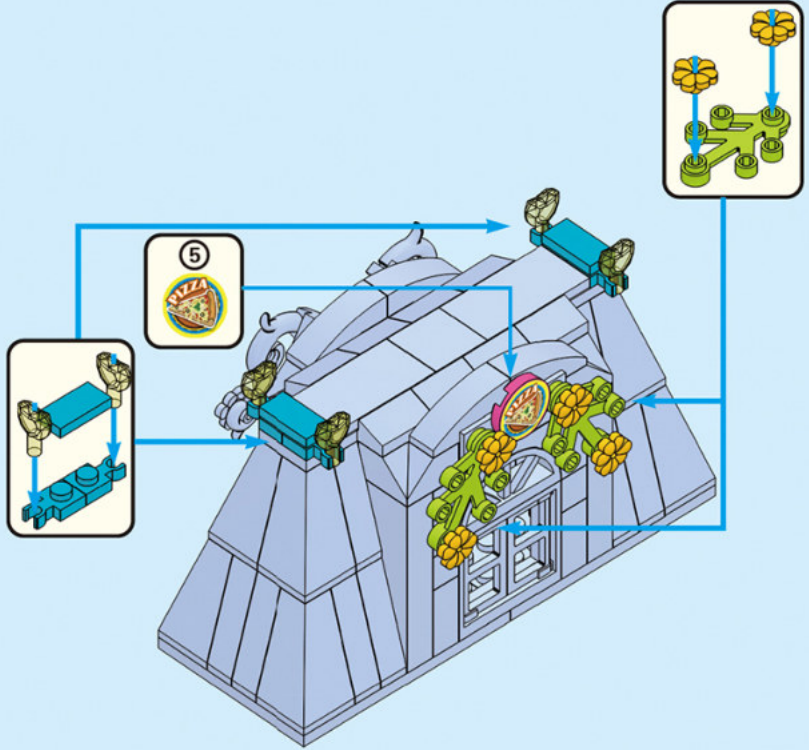

24.

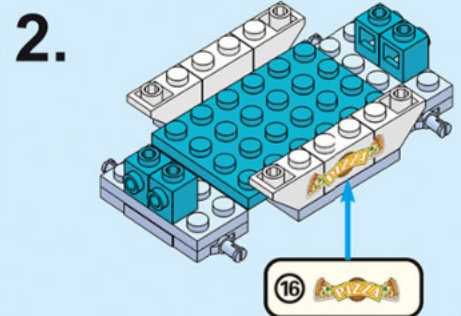
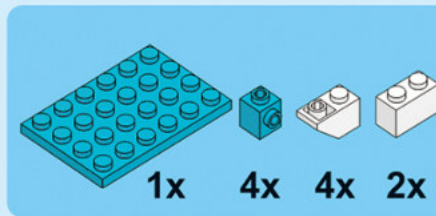
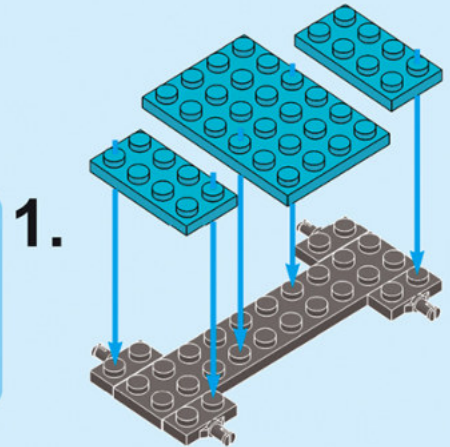
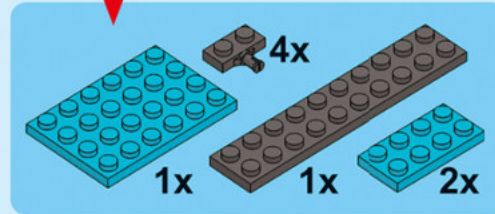
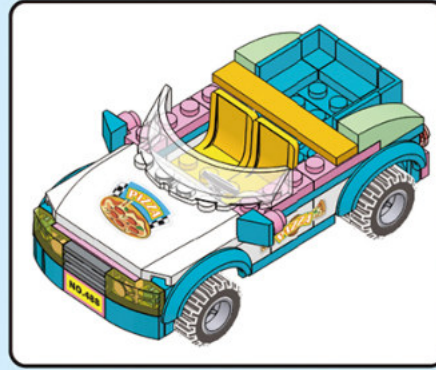

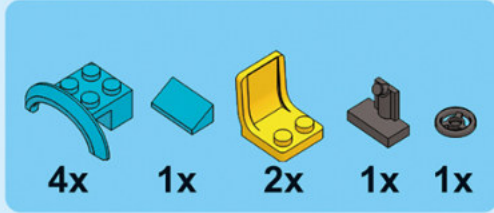

3.

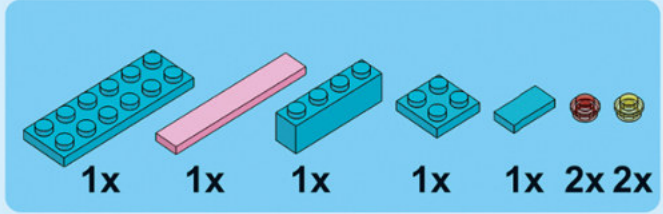
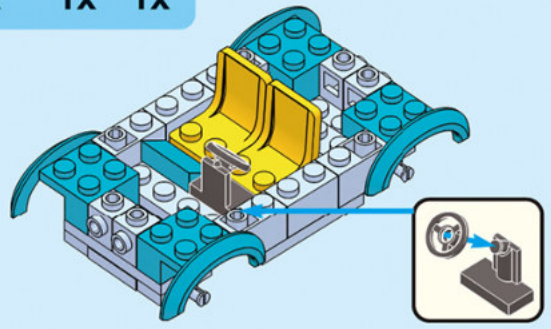

4.

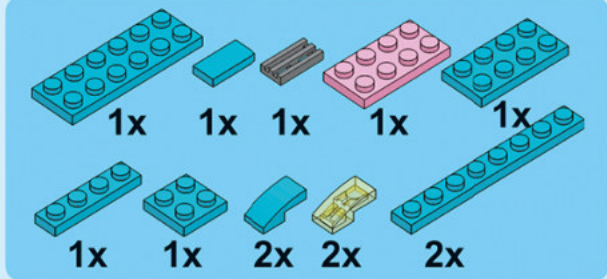
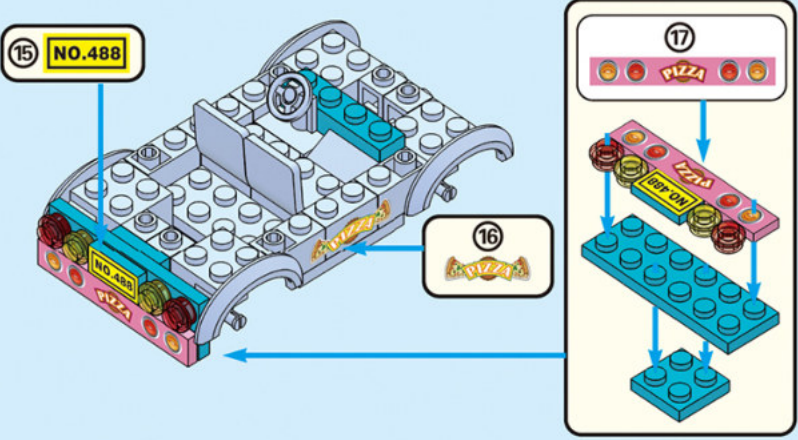

5.

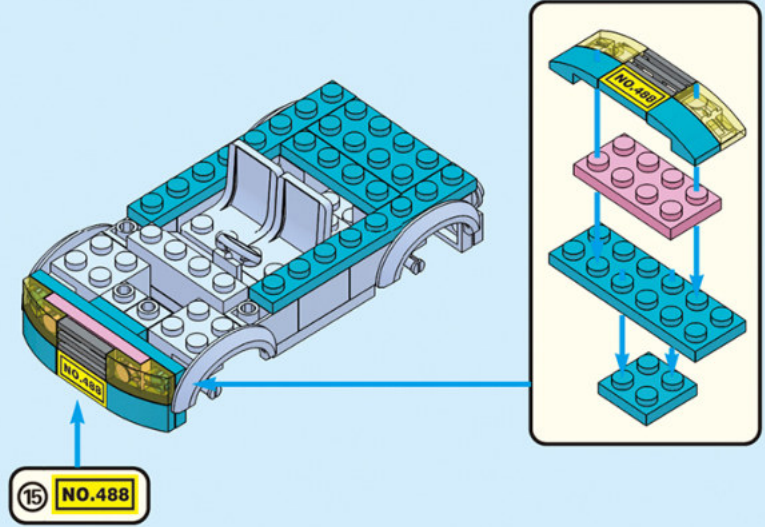



2x 2x 2x 2x

6.

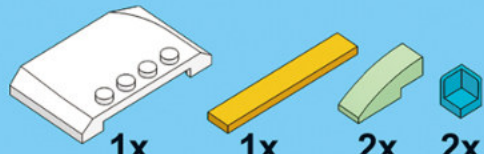
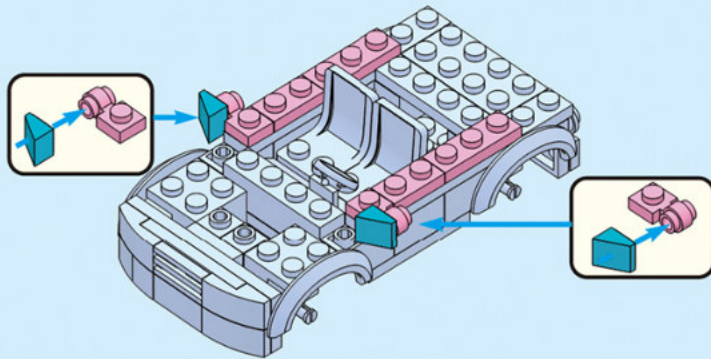

1x 1x 2x 2x

7.

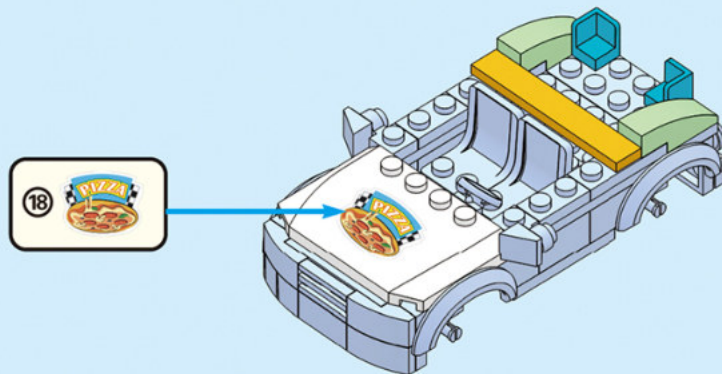

3x 1x

8.

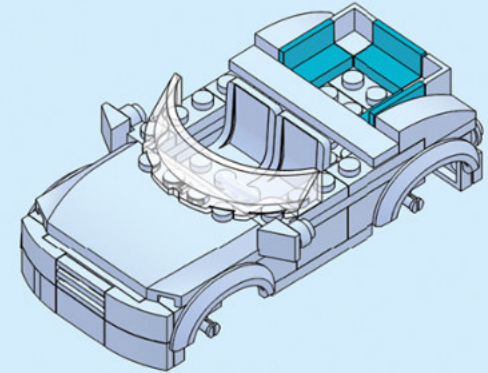

4x 4x

9.

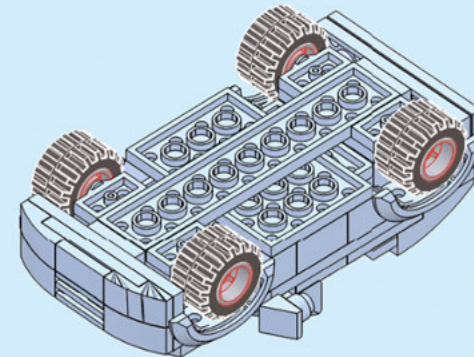

4x