

1. 2x 2x

2. 2x 4x 4x

3. 1x

4. 4x 8x 8x 4x

5. 1x 2x 1x  
1x 1x 1x 6x

5. a b c

6. 1x 2x 2x

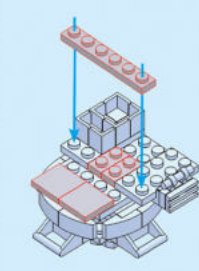

7. 2x 1x 1x  
1x 2x 1x 1x

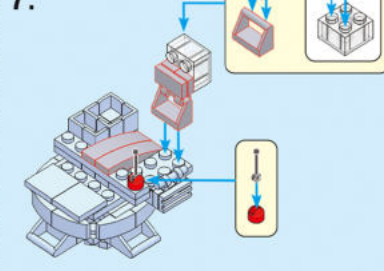

8. 1x 2x 1x 2x 4x

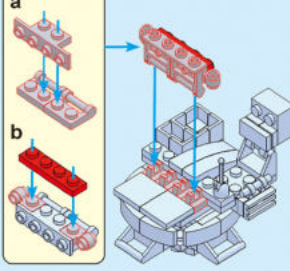

9. 1x 2x  
1x 2x 2x

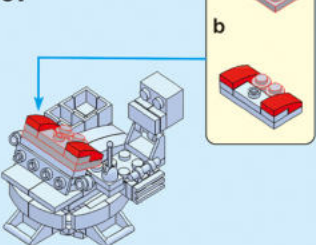

10. 1x 1x 1x 1x 2x  
3x 2x 2x 2x 2x 5x 2x

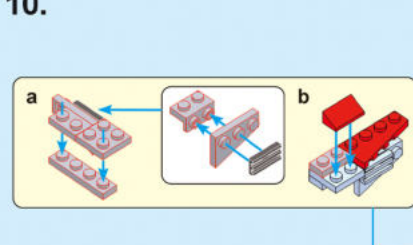

a b

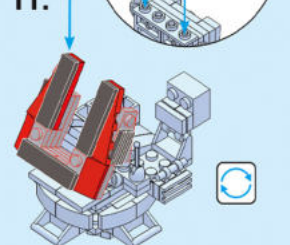
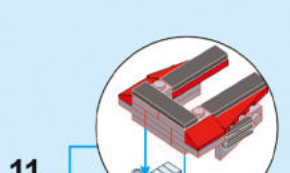
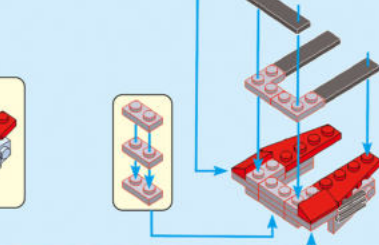

12. 1x 1x 1x 1x

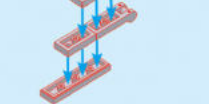

13. 1x 2x 2x 1x

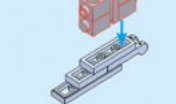

14. 2x 1x 1x 1x  
1x 2x 2x 1x 2x

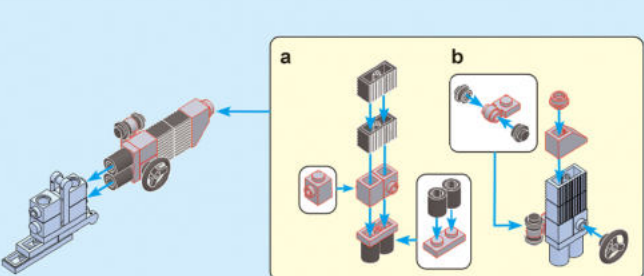
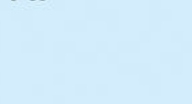

15. 1x 1x 6x1x 3x

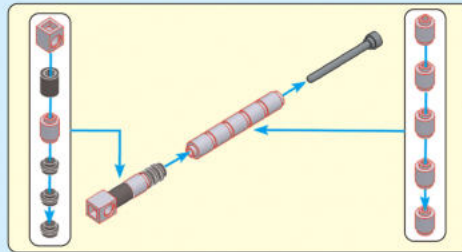
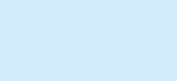

16. 1x 1x 1x 1x

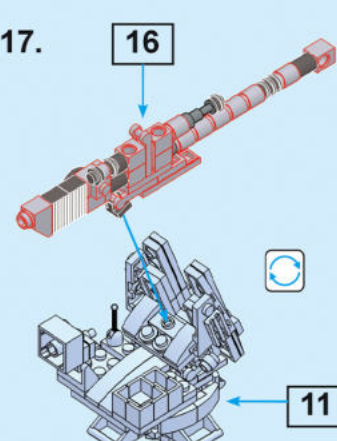
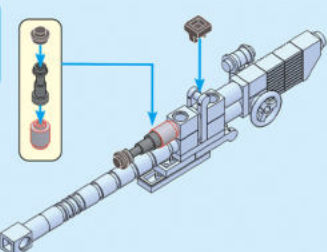
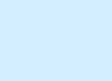

18. 1x 1x 2x

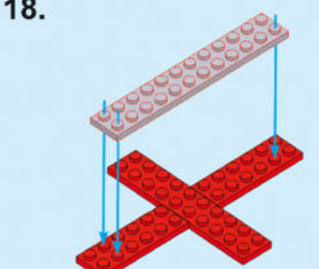

19. 2x 2x 2x

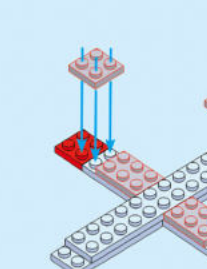

20. 4x 8x 1x

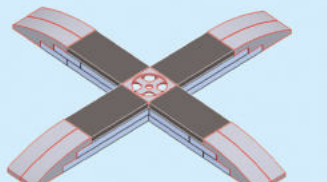
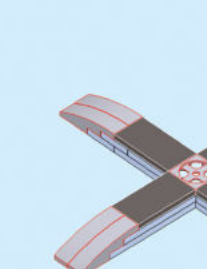

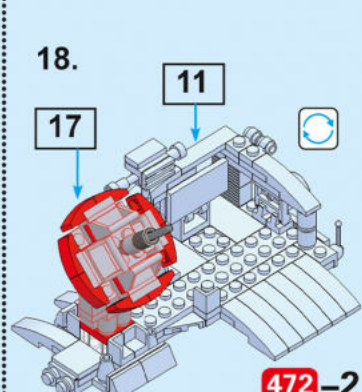
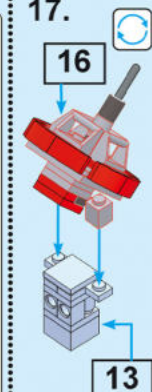
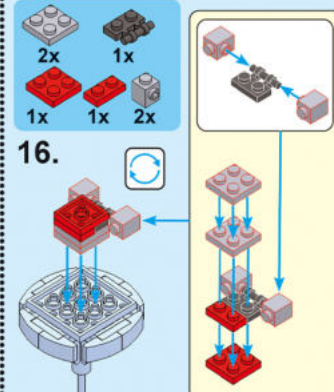
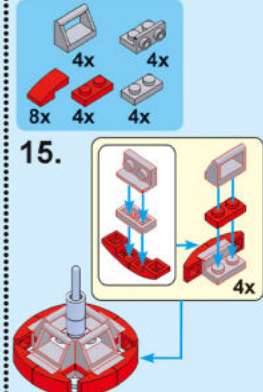
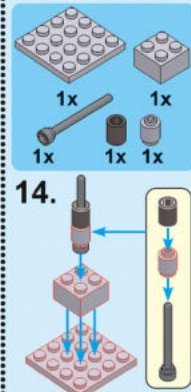
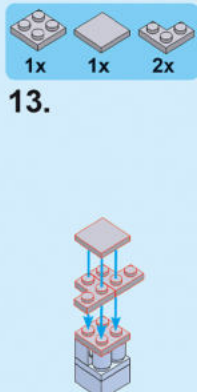
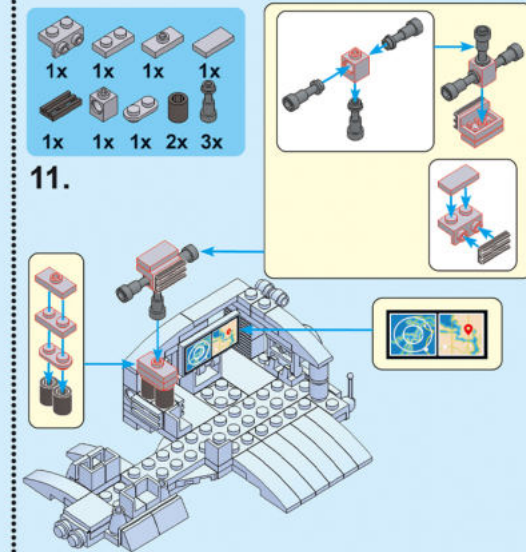
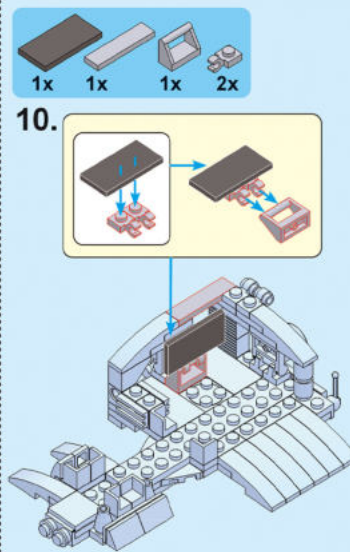
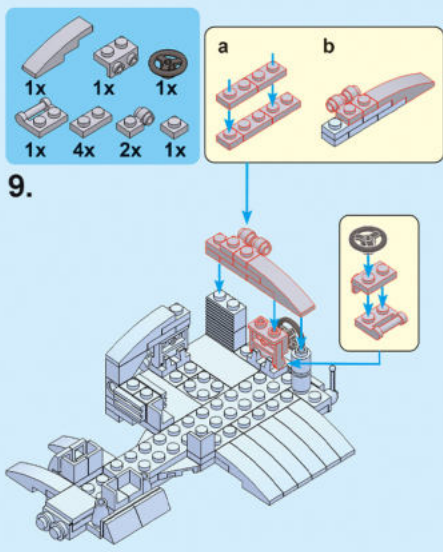
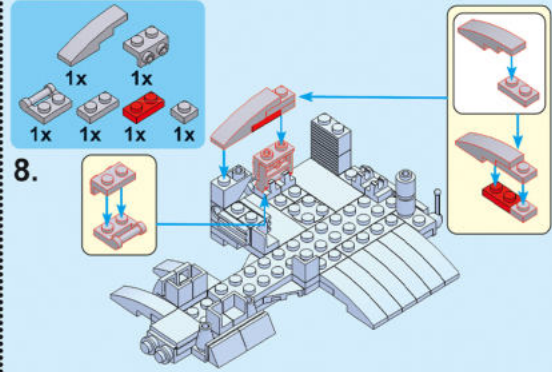
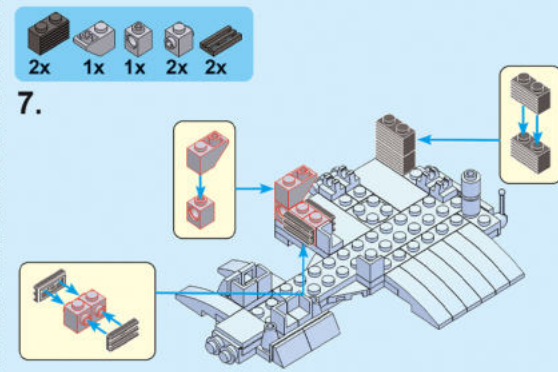
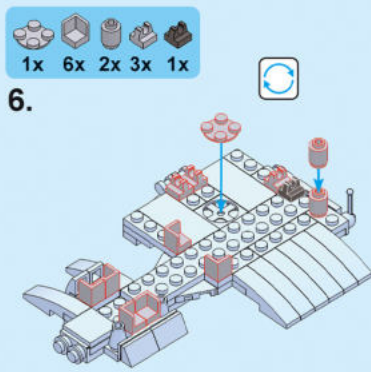
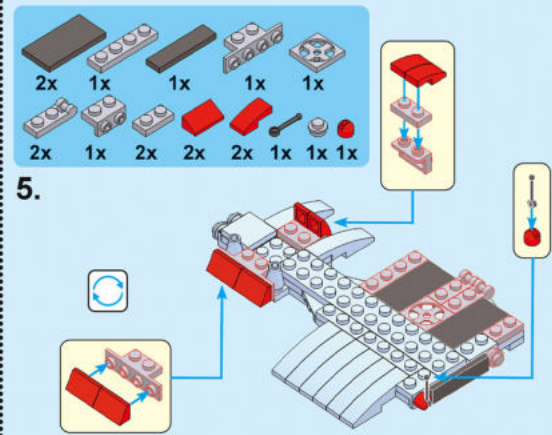
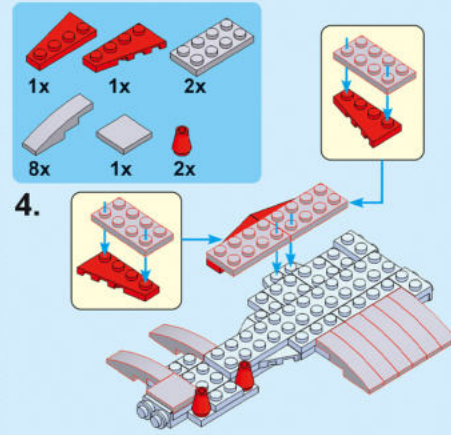
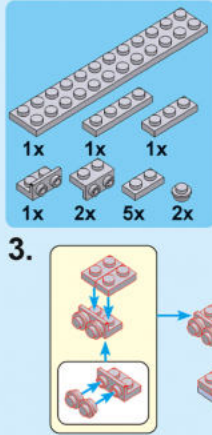
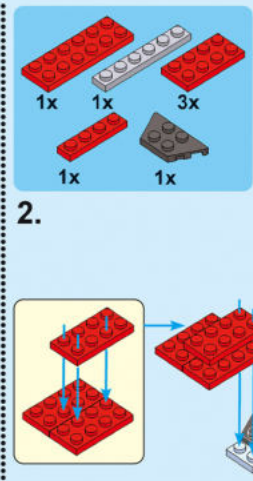
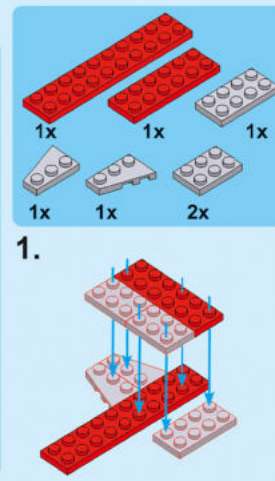
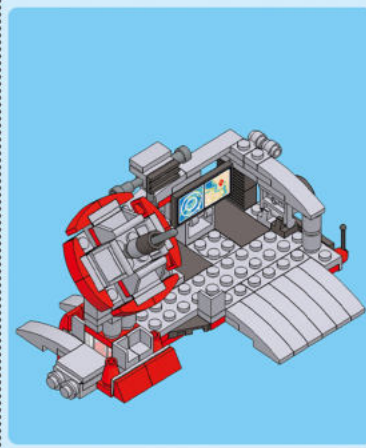
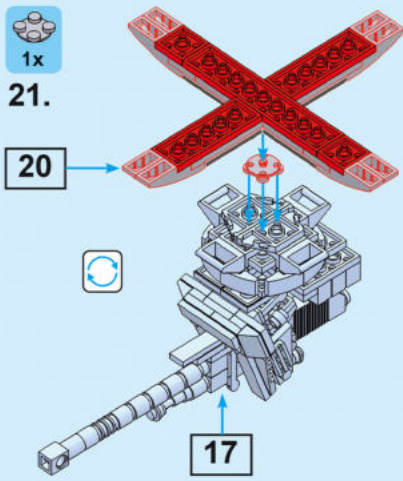

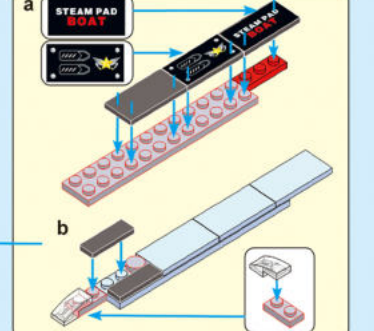
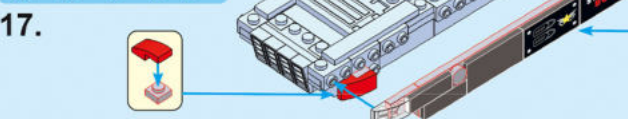
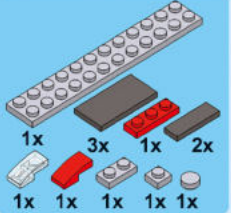
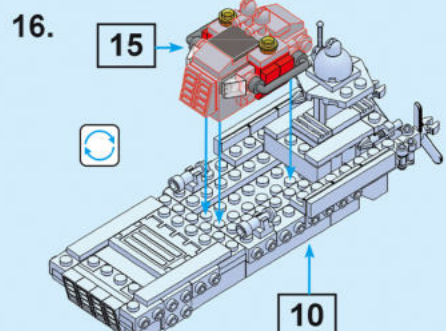
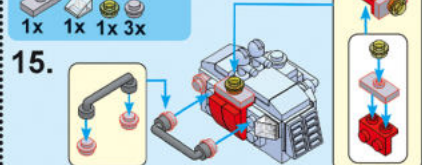
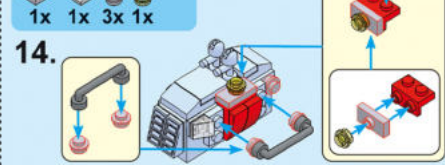
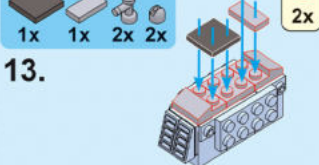
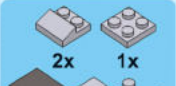
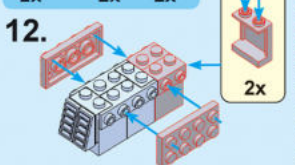
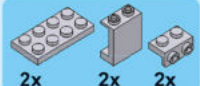
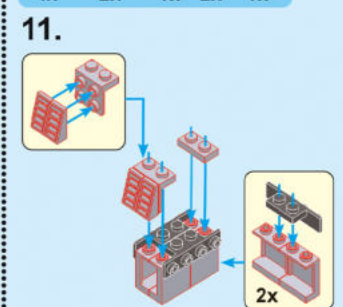
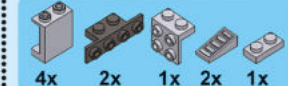
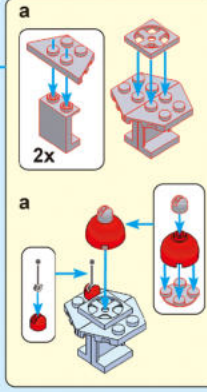
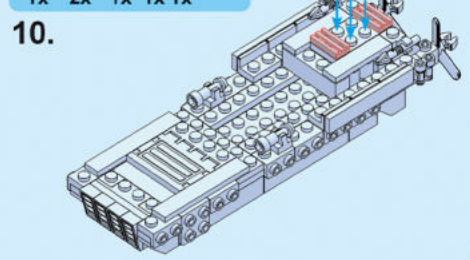
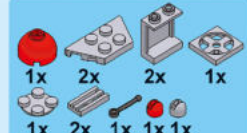
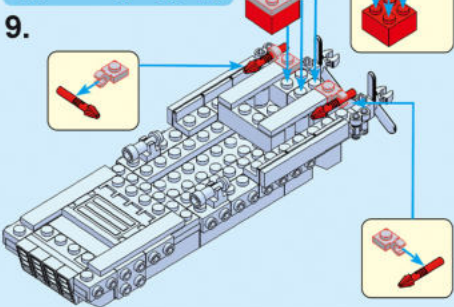
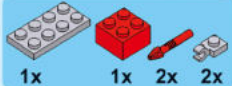
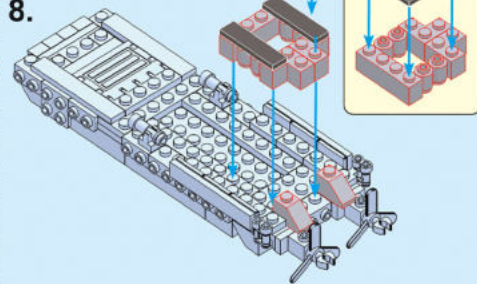
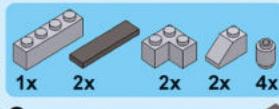
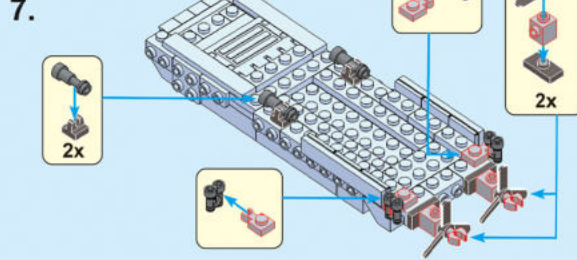
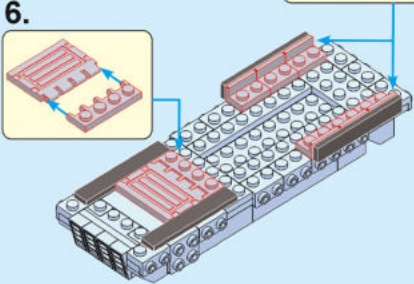
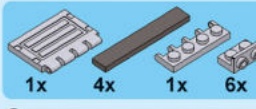
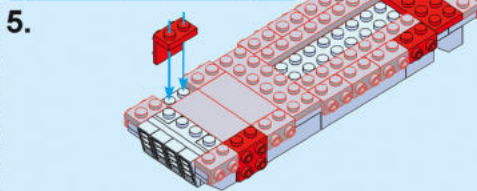
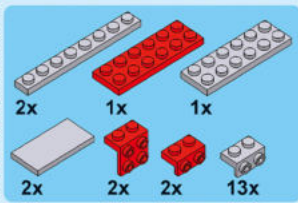
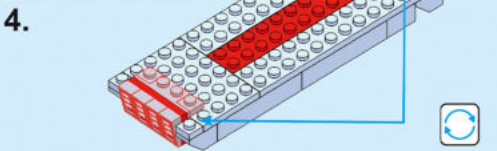
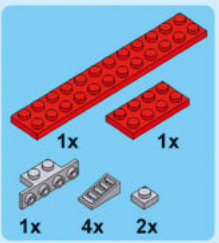
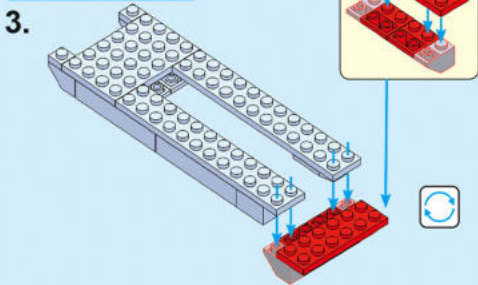
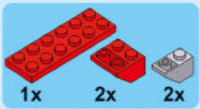
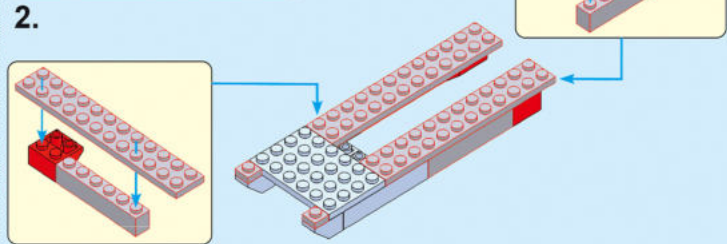
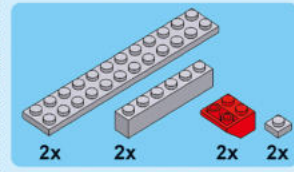
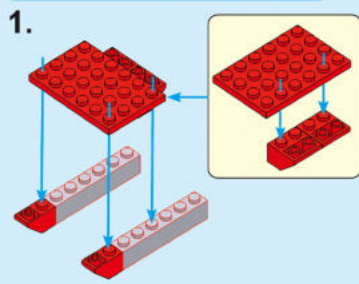
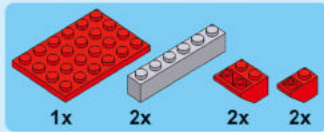
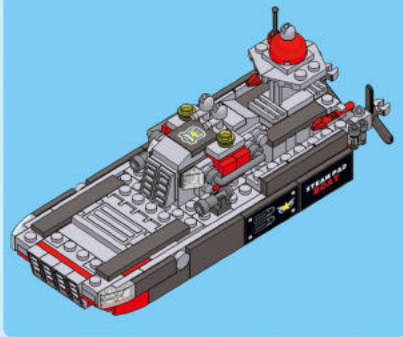

**18.**

**a**

STEAM PAD  
BOAT

1x 2x 1x 1x 1x 1x 1x

1x 2x 1x

**b**

**1.**

**2.**

2x 1x 1x 2x

**3.**

1x 2x 1x 1x 2x 2x

**4.**

4x 1x 4x 2x

**5.**

1x 1x 1x 2x 2x 2x 12x 2x 1x 2x 2x

2x

**6.**

4x 2x 6x 2x

**7.**

2x 2x 4x 2x 2x 2x 2x 2x 2x

2x

**8.**

2x 4x 1x 1x 1x

**9.**

2x 2x 2x

2x

**10.**

1x 1x 1x 1x 1x 1x 1x 1x

**11.**

1x 1x 1x 1x 1x 1x

**12.**

1x 2x 2x 1x

**13.**

1x 1x 2x 1x 1x

**14.**

1x 3x 2x 1x 1x 1x 1x 1x

**7**

**a**

STEAM PAD  
BOAT

**b**

**15.**

1x 3x 1x 2x 1x 1x 1x 1x

**a**

STEAM PAD  
BOAT

**b**

**472-3**



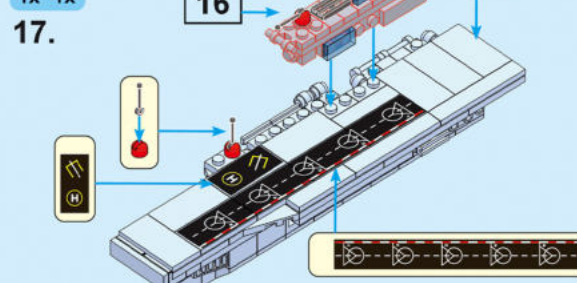
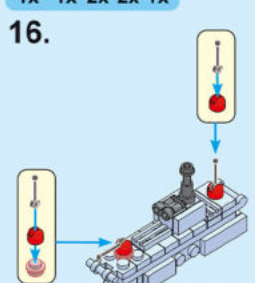
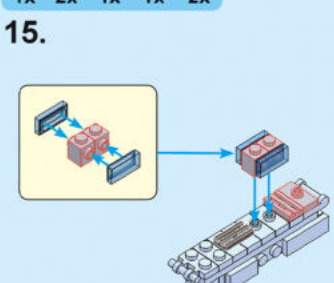
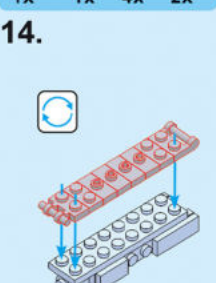
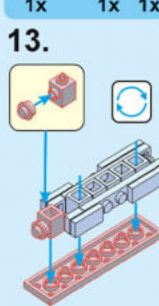
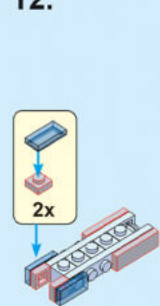
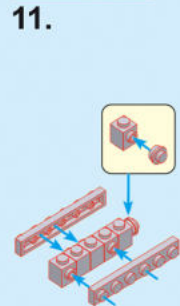
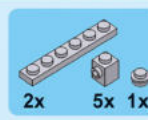
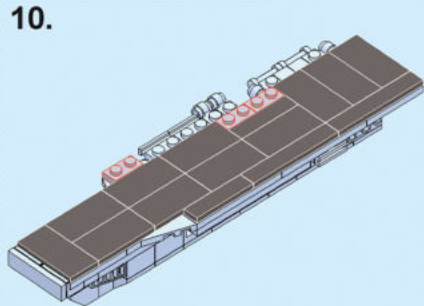
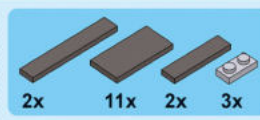
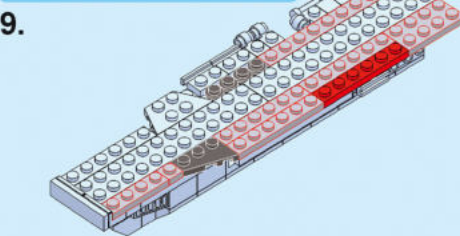
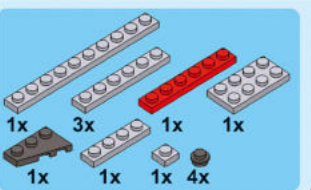
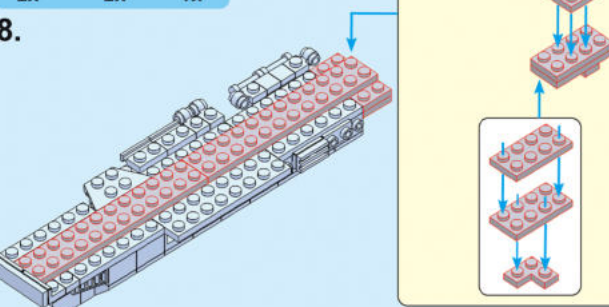
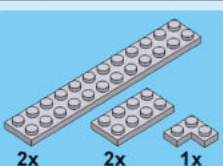
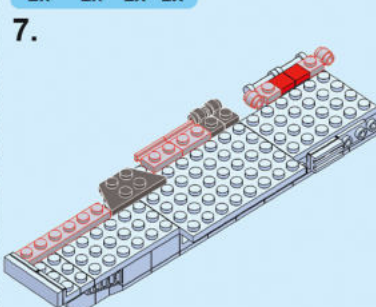
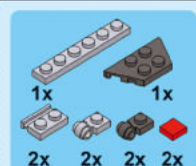
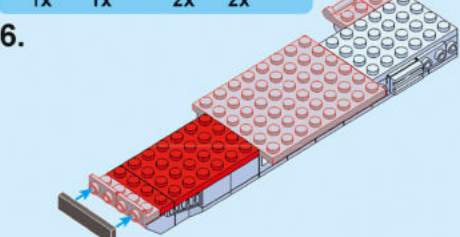
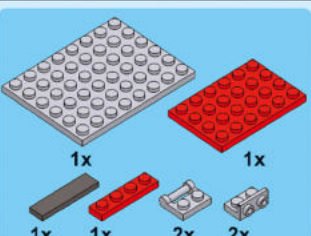
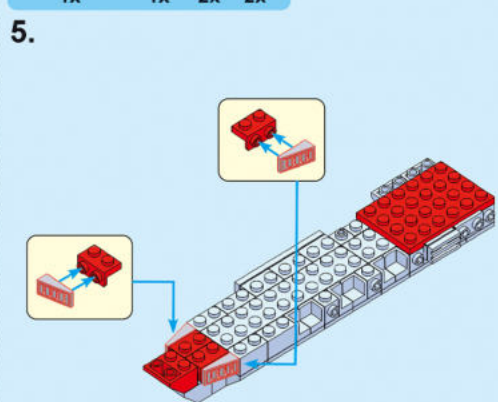
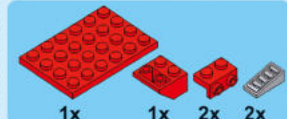
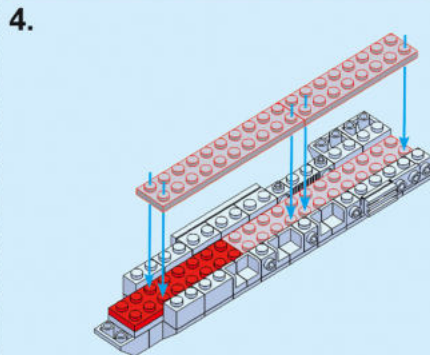
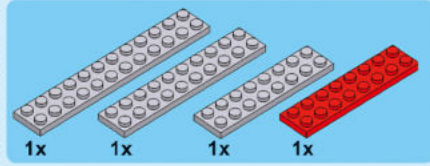
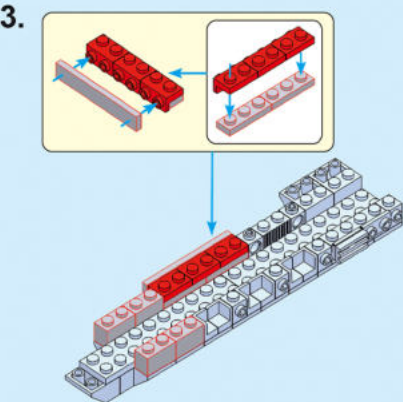
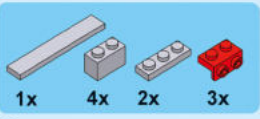
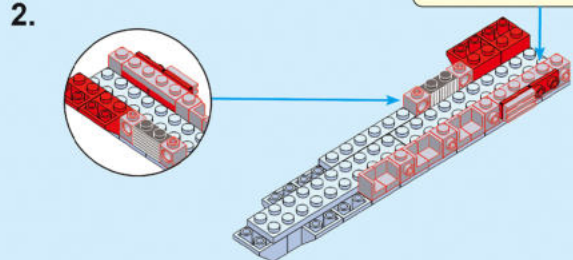
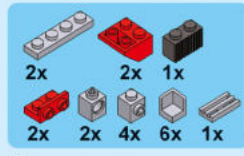
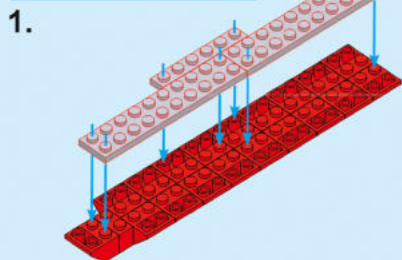
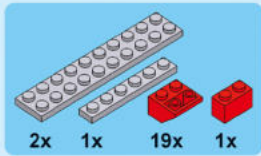
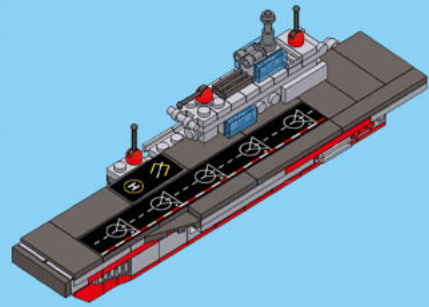

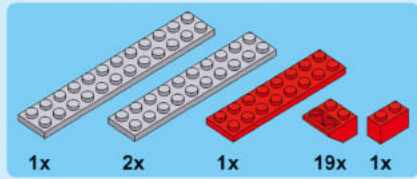
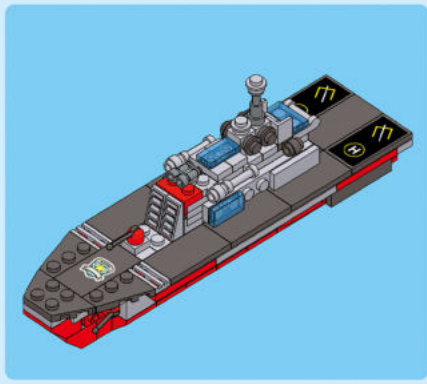

1.

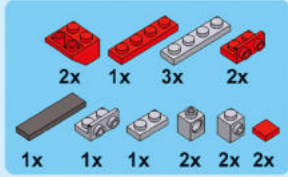
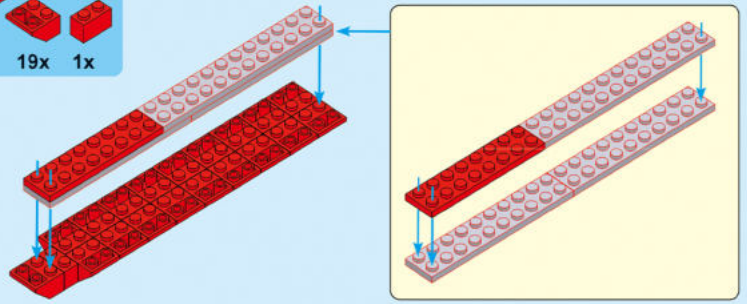

2.

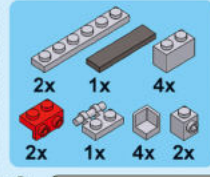
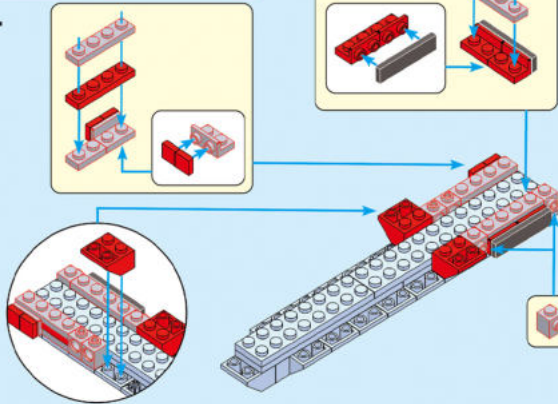

3.

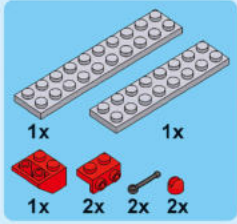
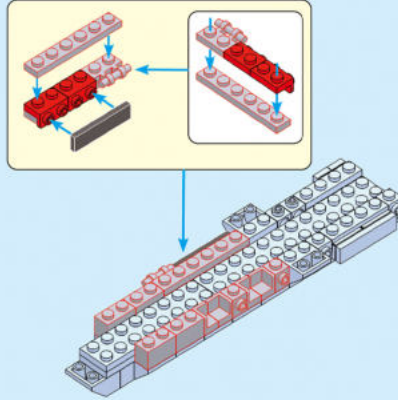

4.

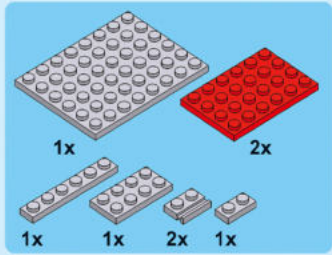
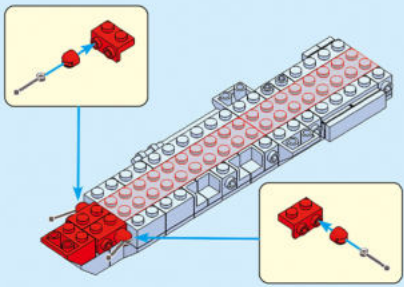

5.

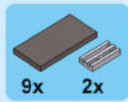
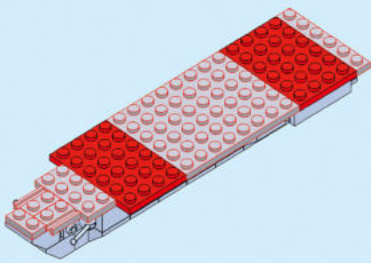

6.

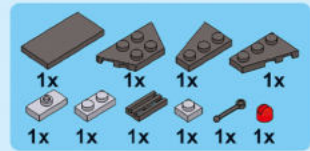
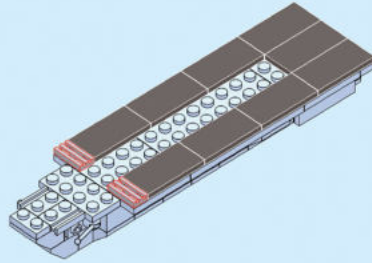

7.

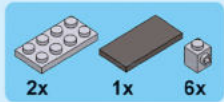
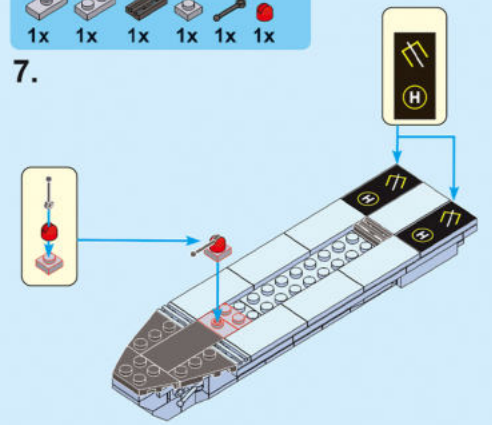

8.

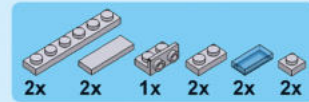
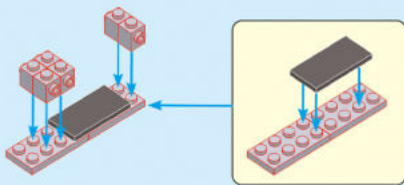

9.

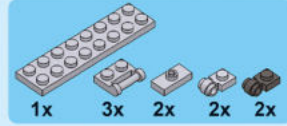
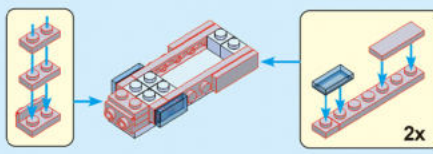

10.

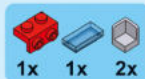
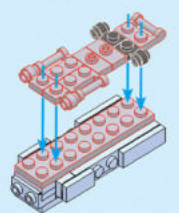

11.

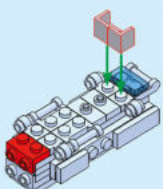

12.

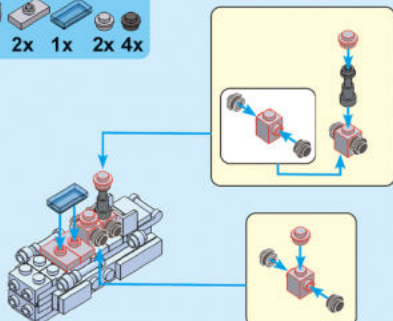

13.

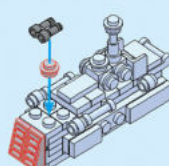

14.

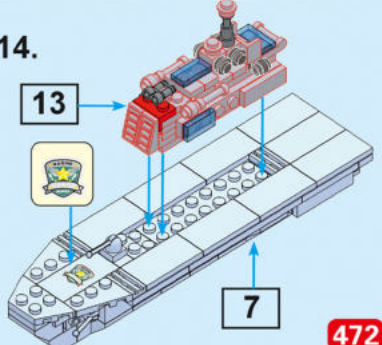

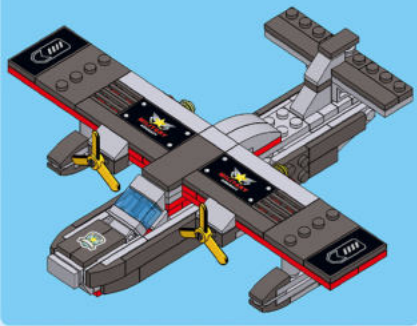

1. 2x 1x 4x

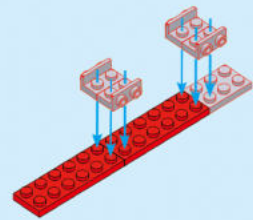

2. 11x

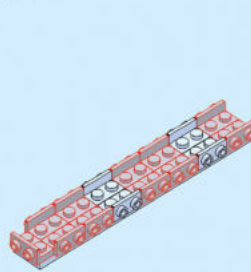

3. 1x 1x 4x 1x 2x 1x

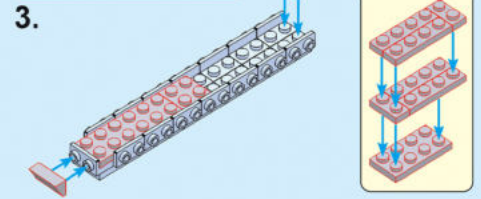

4. 2x 2x 1x

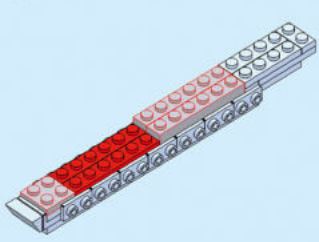

5. 2x 2x 2x 1x

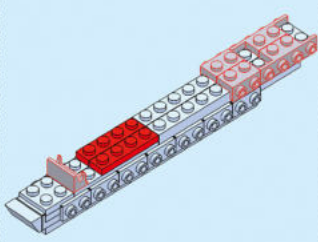

6. 1x 2x 2x 8x 1x 1x 1x 1x

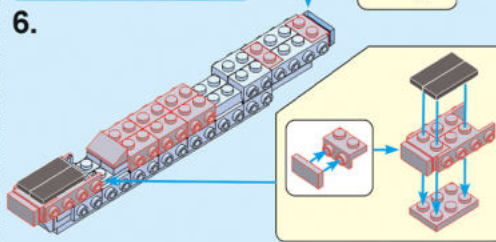

7. 1x 4x 4x

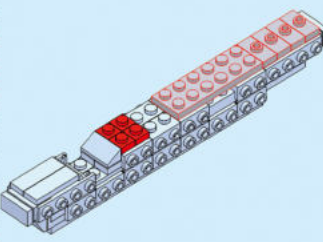

8. 2x 2x 4x 2x 1x 2x 1x 1x 1x 1x 1x 2x 1x

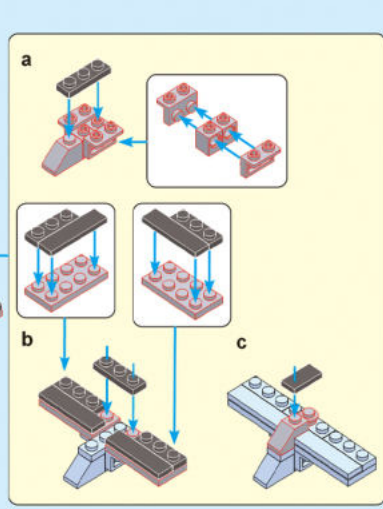
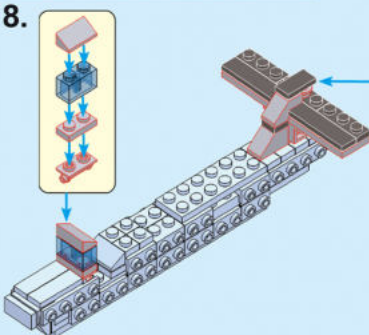

9. 1x 1x 2x 1x 1x 1x 1x 2x 1x 1x

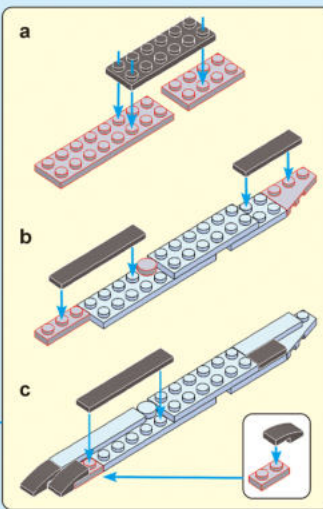
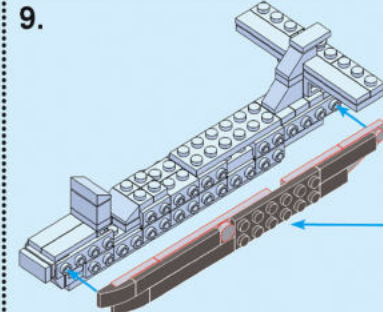

10. 1x 1x 1x 1x 2x 1x 1x 1x

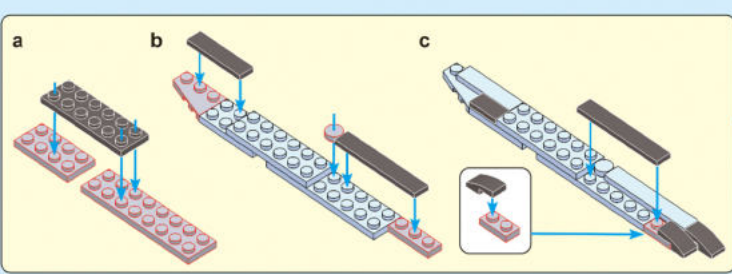

11. 2x 2x 3x

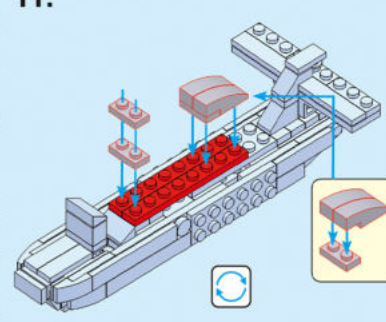

12. 1x 1x

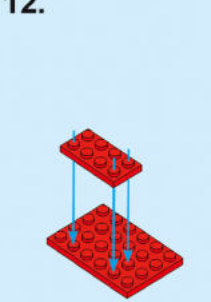

13. 2x 2x 2x 2x

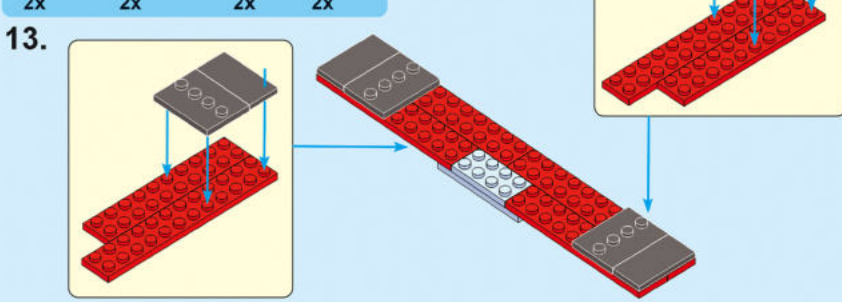

14. 2x 2x 2x 4x

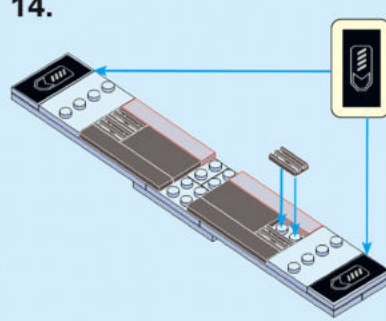

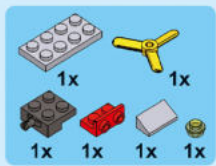

15.

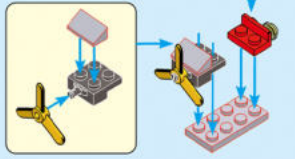

16.

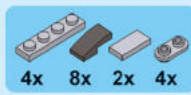
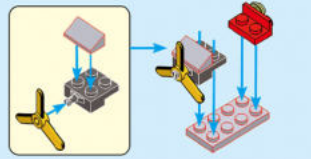

17.

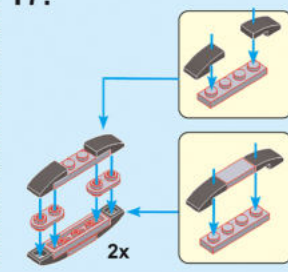

18.

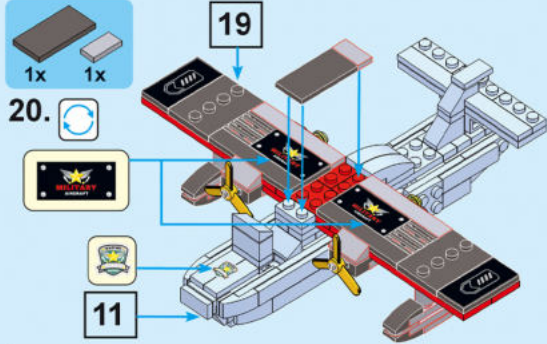
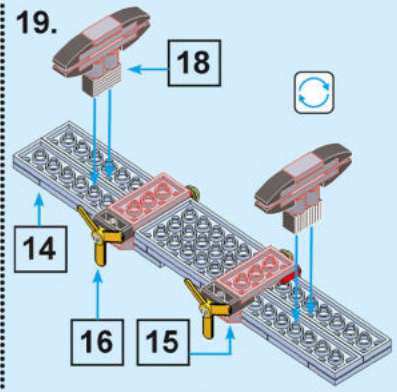
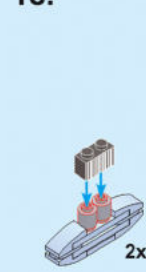

20.

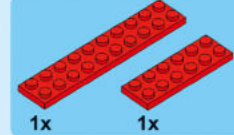
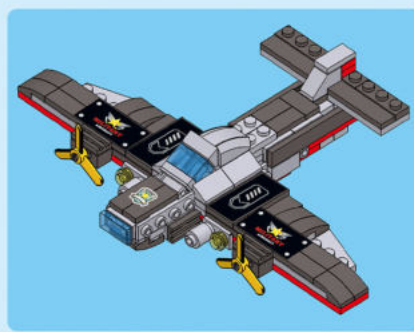

1.

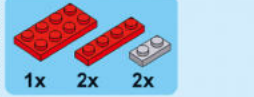
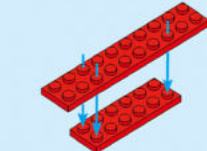

2.

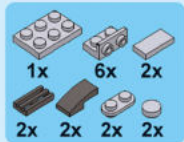
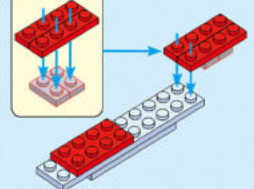

3.

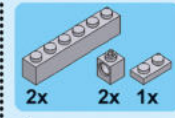
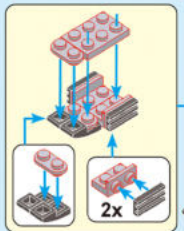
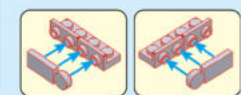

4.

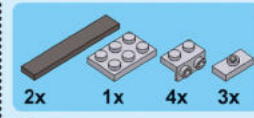
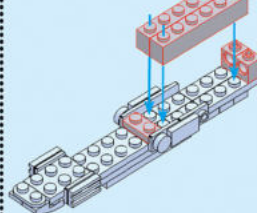

5.

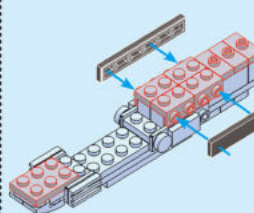

6.

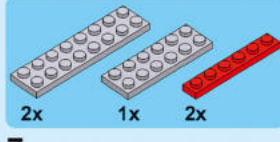
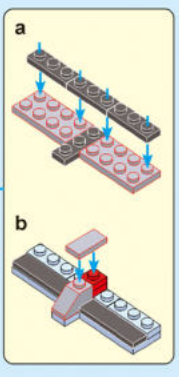
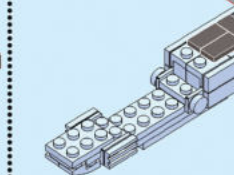

7.

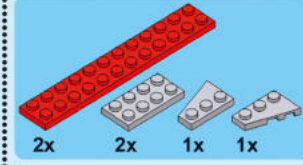
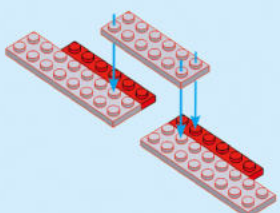

8.

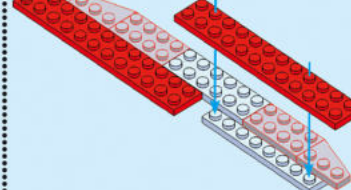

9.

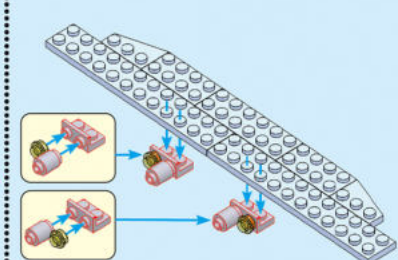

10.

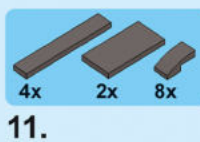
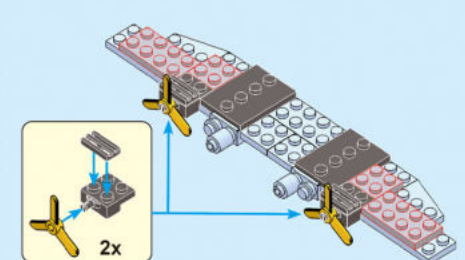

11.

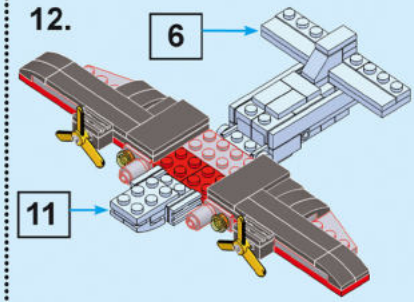
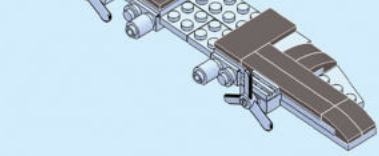

12.



13.

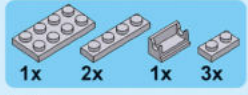

14.

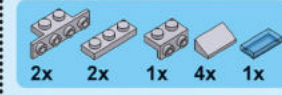
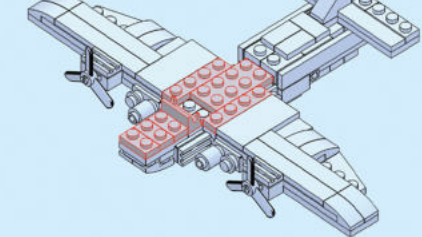

15.

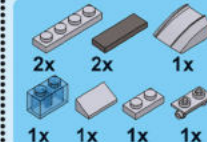
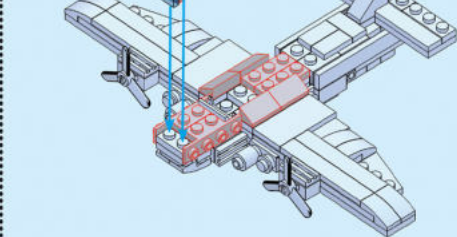

16.

