

1. 1x [red 1x6 Technic beam], 4x [red 1x2 Technic beam]

2. 1x [red 1x6 Technic beam], 1x [red 1x2 Technic beam], 2x [red 1x1 Technic pin], 1x [grey 1x2 Technic Technic connector]

1x [grey 1x2 Technic Technic connector], 2x [grey 1x1 Technic pin], 2x [grey 1x2 Technic Technic connector], 1x [grey 1x1 Technic pin], 1x [grey 1x2 Technic Technic connector]

3. [Assembly diagram showing the attachment of the grey Technic connector and pins to the bottom of the aircraft fuselage.]

1x [grey 1x1 Technic pin], 1x [grey 1x2 Technic Technic connector], 5x [grey 1x1 Technic pin], 4x [grey 1x2 Technic Technic connector], 2x [grey 1x1 Technic pin]

4. [Assembly diagram showing the attachment of multiple grey Technic pins and connectors to the bottom of the aircraft fuselage.]

2x [grey 1x1 Technic pin], 2x [grey 1x2 Technic Technic connector], 2x [grey 1x1 Technic pin]

5. [Assembly diagram showing the attachment of grey Technic pins and connectors to the bottom of the aircraft fuselage, with a circular arrow indicating a rotation step.]

1x [grey 1x2 Technic Technic connector], 1x [grey 1x1 Technic pin], 1x [grey 1x2 Technic Technic connector], 1x [grey 1x1 Technic pin], 1x [grey 1x2 Technic Technic connector], 1x [grey 1x1 Technic pin], 1x [grey 1x2 Technic Technic connector], 2x [grey 1x1 Technic pin], 2x [grey 1x2 Technic Technic connector], 1x [grey 1x1 Technic pin], 1x [grey 1x2 Technic Technic connector], 2x [grey 1x1 Technic pin], 1x [grey 1x2 Technic Technic connector]

6. [Assembly diagram showing the attachment of various grey Technic pins and connectors to the bottom of the aircraft fuselage, with a circular arrow indicating a rotation step.]

1x [red 1x6 Technic beam], 1x [red 1x2 Technic beam], 2x [red 1x1 Technic pin], 1x [red 1x2 Technic beam]

7. [Assembly diagram showing the attachment of red Technic beams and pins to the bottom of the aircraft fuselage.]

1x [red 1x2 Technic beam], 1x [red 1x1 Technic pin], 1x [red 1x2 Technic beam]

8. [Assembly diagram showing the attachment of red Technic beams and pins to the bottom of the aircraft fuselage.]

1x [grey 1x2 Technic Technic connector], 3x [grey 1x1 Technic pin], 1x [grey 1x2 Technic Technic connector], 1x [grey 1x1 Technic pin], 1x [grey 1x2 Technic Technic connector], 4x [grey 1x1 Technic pin]

9. [Assembly diagram showing the attachment of grey Technic pins and connectors to the bottom of the aircraft fuselage.]

2x [grey 1x1 Technic pin]

10. [Assembly diagram showing the attachment of grey Technic pins to the bottom of the aircraft fuselage, with a circular arrow indicating a rotation step.]

1x [red 1x6 Technic beam], 1x [red 1x2 Technic beam], 1x [red 1x1 Technic pin], 2x [red 1x2 Technic beam]

11. [Assembly diagram showing the attachment of red Technic beams and pins to the bottom of the aircraft fuselage.]

1x [red 1x2 Technic beam], 1x [red 1x1 Technic pin], 1x [red 1x2 Technic beam]

12. [Assembly diagram showing the attachment of red Technic beams and pins to the bottom of the aircraft fuselage.]

3x [grey 1x2 Technic Technic connector], 1x [grey 1x1 Technic pin], 1x [grey 1x2 Technic Technic connector], 1x [grey 1x1 Technic pin], 1x [grey 1x2 Technic Technic connector], 4x [grey 1x1 Technic pin]

13. [Assembly diagram showing the attachment of grey Technic pins and connectors to the bottom of the aircraft fuselage.]

2x [grey 1x1 Technic pin]

14. [Assembly diagram showing the attachment of grey Technic pins to the bottom of the aircraft fuselage, with a circular arrow indicating a rotation step.]

15. [Assembly diagram showing the attachment of grey Technic pins and connectors to the bottom of the aircraft fuselage, with callouts 6 and 14.]

1x [grey 1x2 Technic Technic connector], 2x [grey 1x1 Technic pin], 1x [grey 1x2 Technic Technic connector], 1x [grey 1x1 Technic pin], 2x [grey 1x2 Technic Technic connector], 2x [grey 1x1 Technic pin]

16. [Assembly diagram showing the attachment of grey Technic pins and connectors to the bottom of the aircraft fuselage, with callouts 6 and 14.]

8x [grey 1x2 Technic Technic connector], 2x [grey 1x1 Technic pin], 4x [grey 1x2 Technic Technic connector]

17. [Assembly diagram showing the attachment of grey Technic pins and connectors to the bottom of the aircraft fuselage, with callouts 2x.]

1x [grey 1x2 Technic Technic connector], 2x [grey 1x1 Technic pin], 1x [grey 1x2 Technic Technic connector], 2x [grey 1x1 Technic pin], 2x [grey 1x2 Technic Technic connector], 2x [grey 1x1 Technic pin]

18. [Assembly diagram showing the attachment of grey Technic pins and connectors to the bottom of the aircraft fuselage, with callouts 2x.]

1x [grey 1x2 Technic Technic connector], 1x [grey 1x1 Technic pin], 2x [grey 1x2 Technic Technic connector]

19. [Assembly diagram showing the attachment of grey Technic pins and connectors to the bottom of the aircraft fuselage.]

2x [grey 1x2 Technic Technic connector], 4x [grey 1x1 Technic pin], 6x [grey 1x2 Technic Technic connector]

20. [Assembly diagram showing the attachment of grey Technic pins and connectors to the bottom of the aircraft fuselage, with callouts 2x.]

[Assembly diagram showing the attachment of a grey Technic pin and connector to the motor area of the aircraft, with a 'POWER' label and a circular arrow indicating a rotation step.]

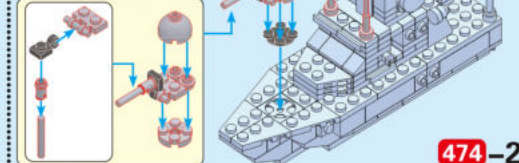
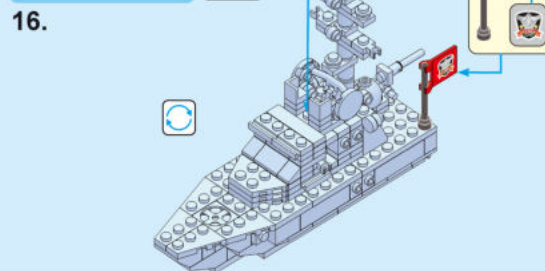
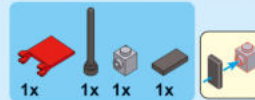
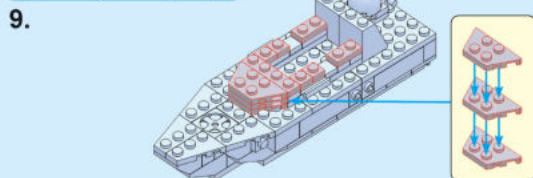
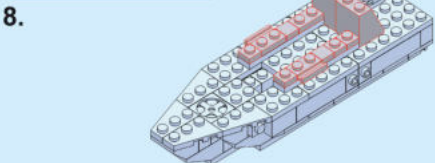
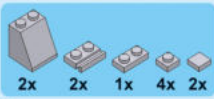
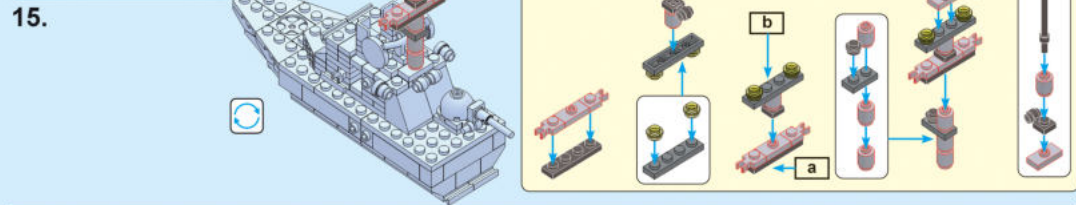
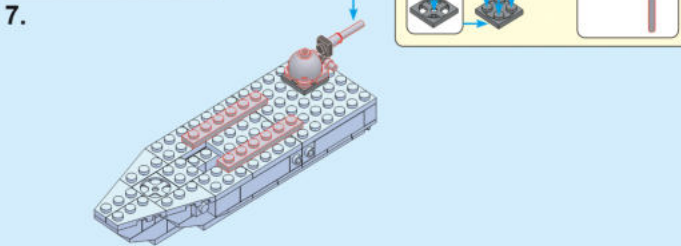
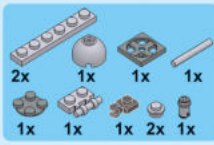
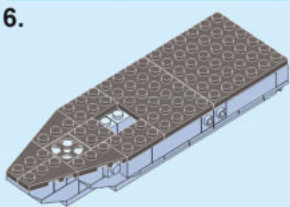
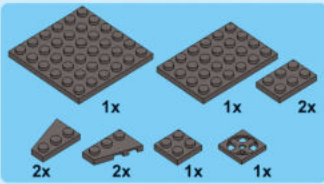
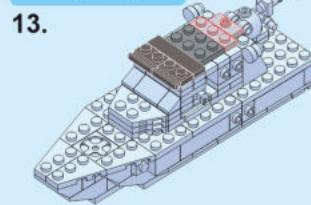
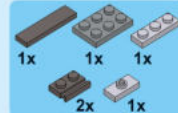
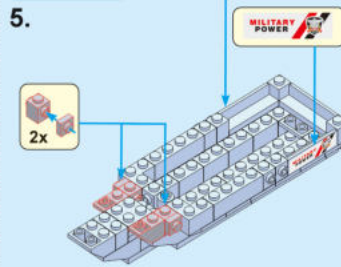
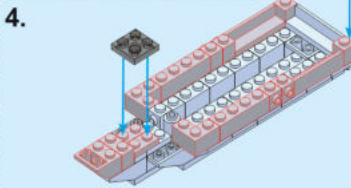
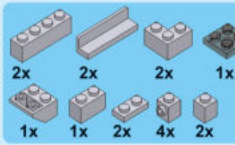
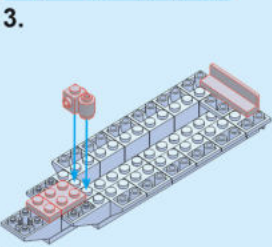
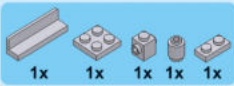
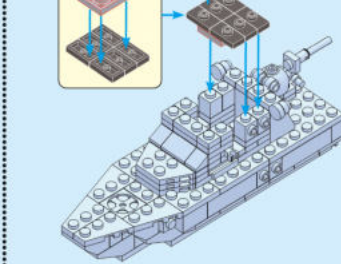
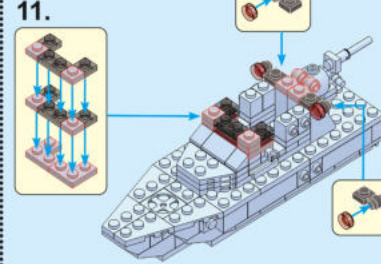
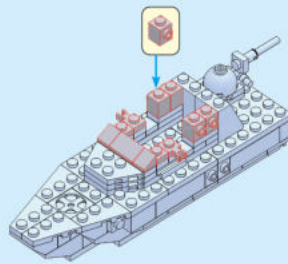
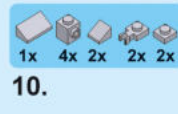
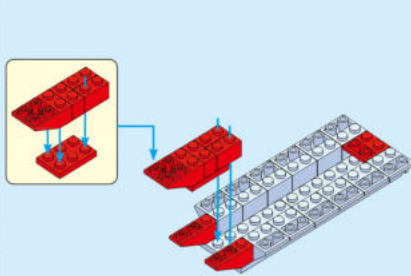
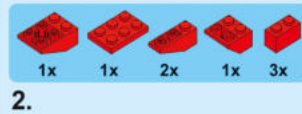
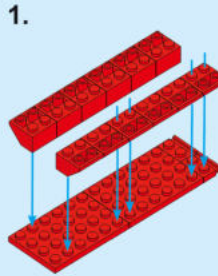
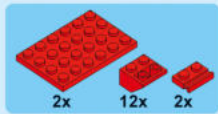

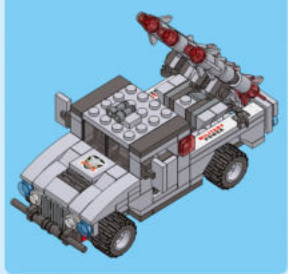

1.

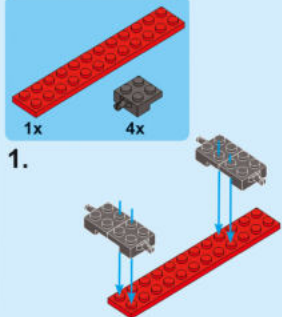

2.

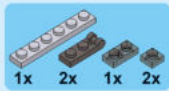
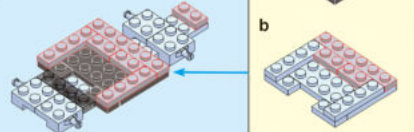

3.

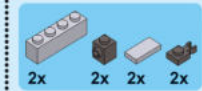
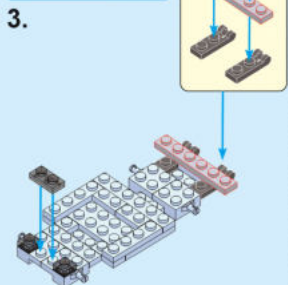

4.

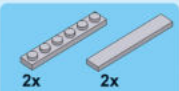
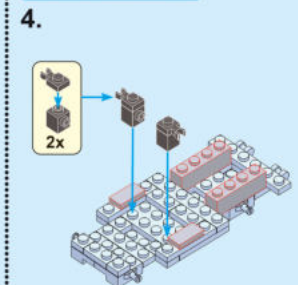

5.

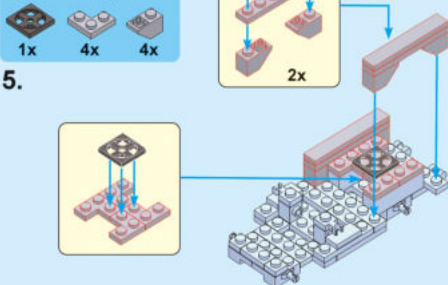

6.

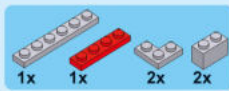
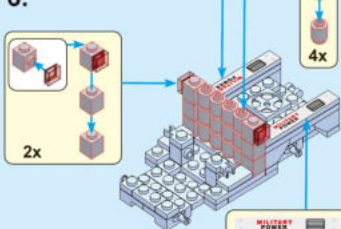

7.

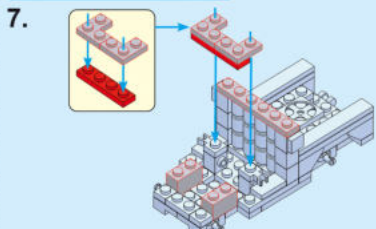

8.

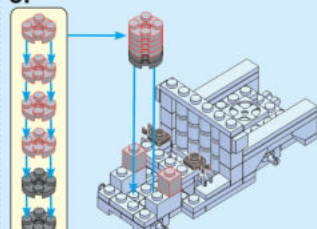

9.

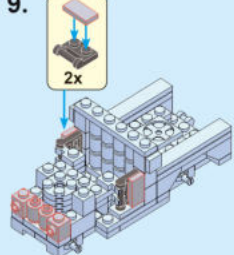

10.

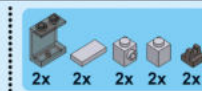
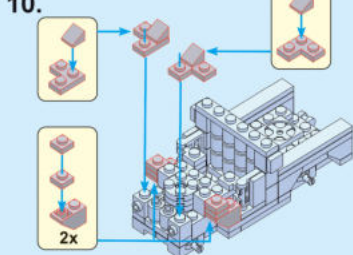

11.

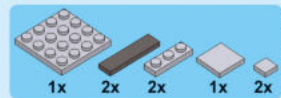
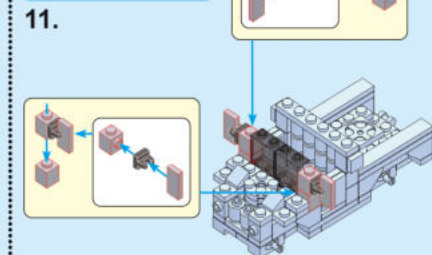

12.

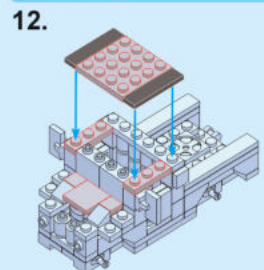

13.

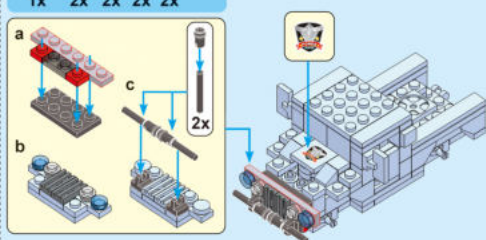

14.

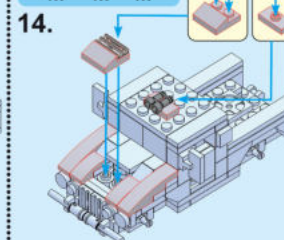

15.

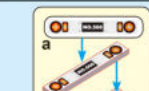
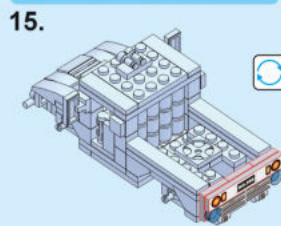

16.

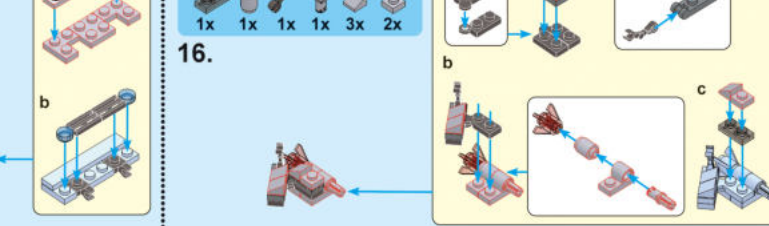

17.

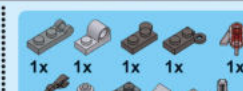
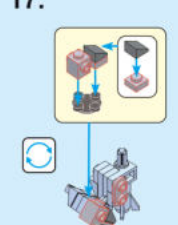

18.

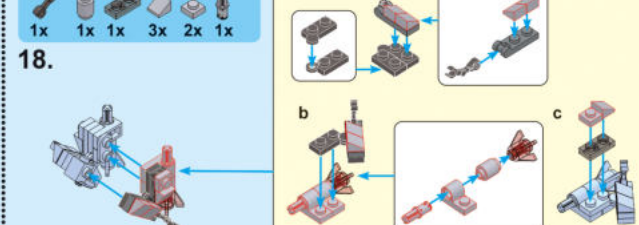

19.

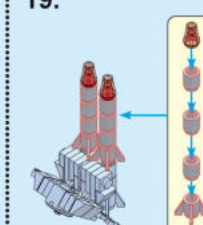

20.

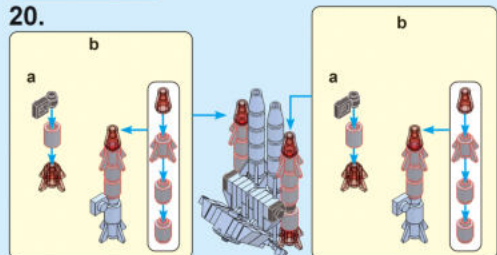

21.

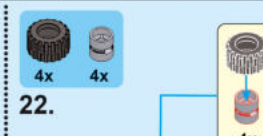
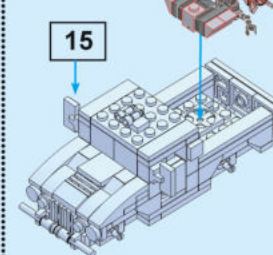

22.

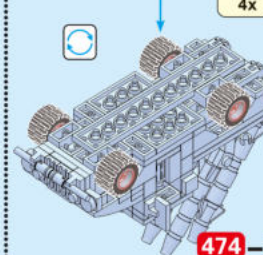

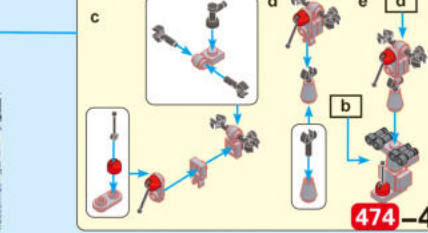
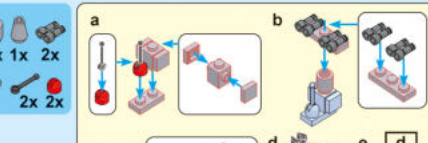
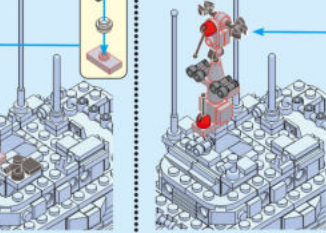
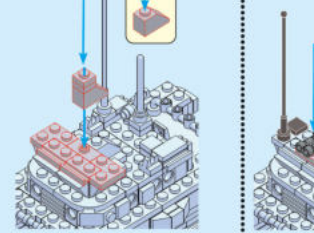
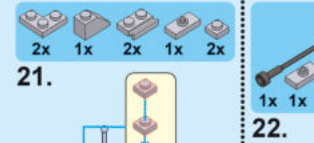
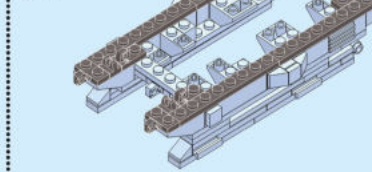
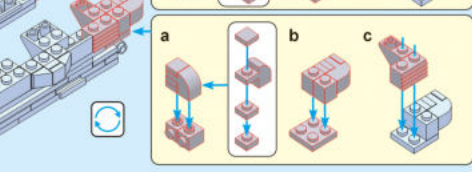
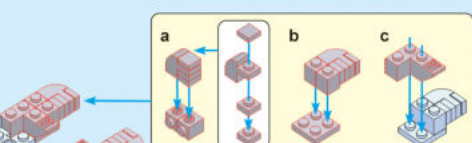
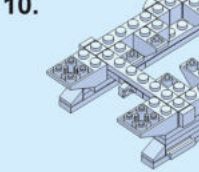
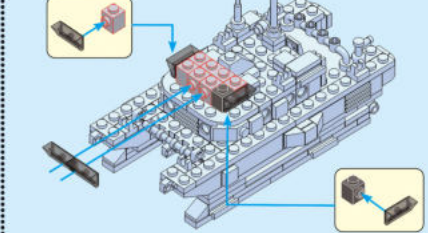
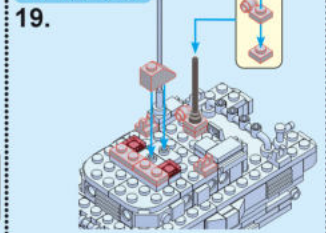
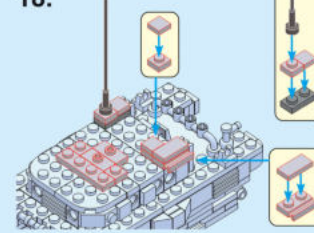
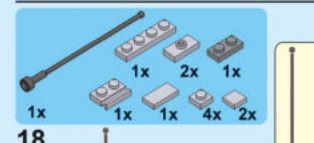
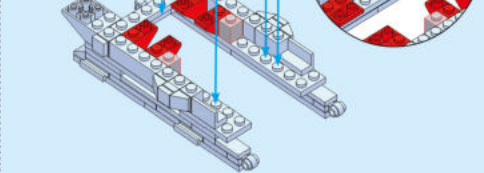
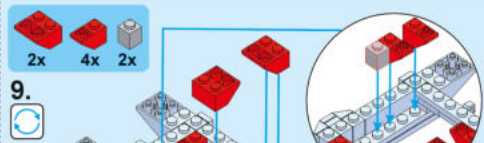
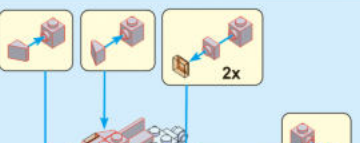
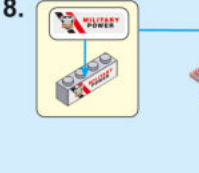
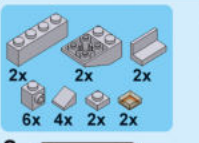
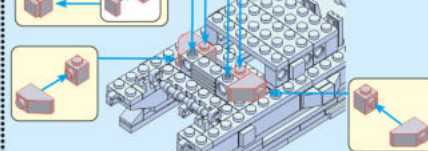
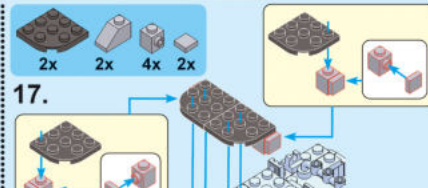
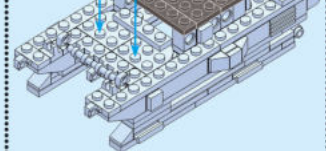
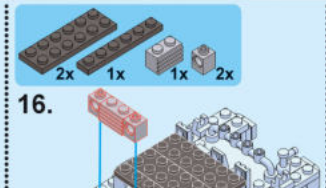
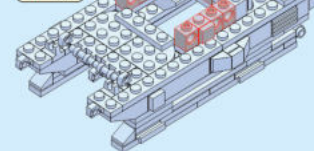
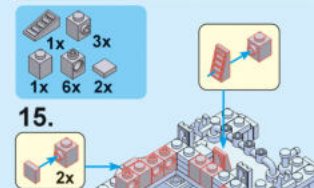
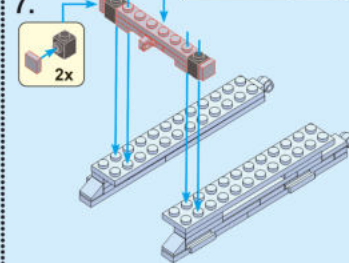
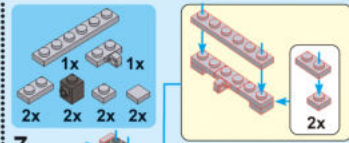
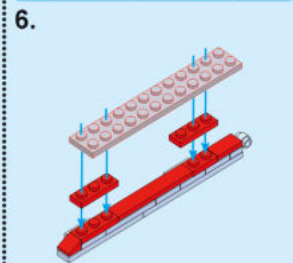
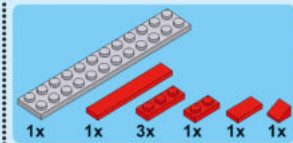
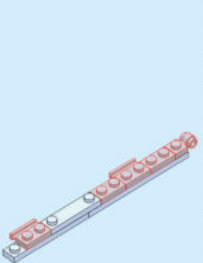
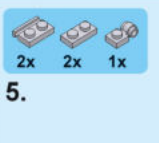
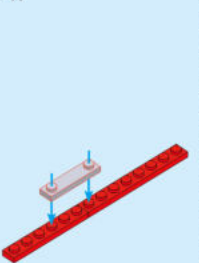
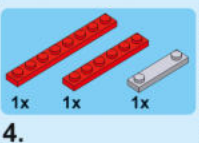
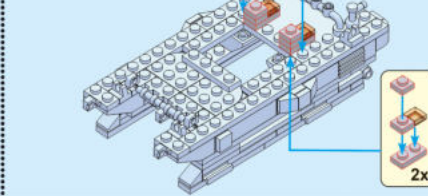
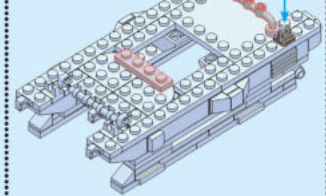
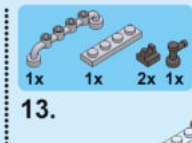
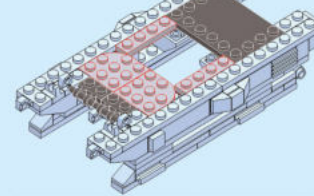
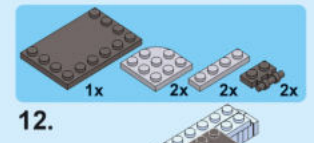
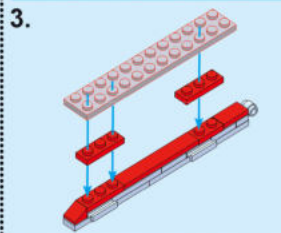
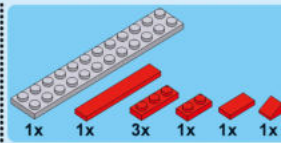
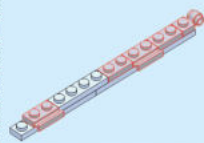
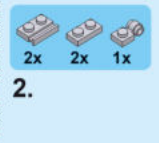
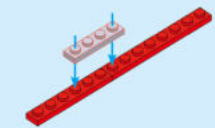
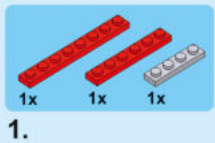
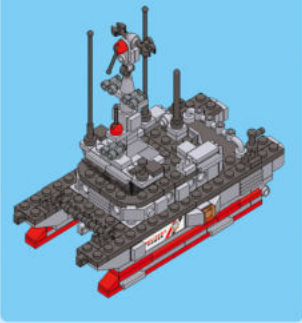

1.

2x 4x 1x

2.

2x 4x

3.

1x 4x 1x
1x 2x 1x 2x

a b

15.

2x 2x 1x
2x 1x 2x

16.

2x 1x 1x 2x
1x 2x 2x 2x

a

2x

b

2x

4.

2x 2x 2x 1x

5.

1x 2x 1x
1x 2x 1x 2x

6.

1x 1x 1x 1x
1x 1x 1x 1x 2x

7.

1x 1x 1x 1x

17.

2x 3x 1x 1x
1x 1x 1x 1x 1x

a

b

c

18.

1x 1x 4x 1x 1x

8.

3x

9.

1x

8

5

10.

1x 1x 1x 1x
1x 1x 1x 1x 2x

19.

2x 2x 2x
2x 2x 2x 2x

a b

a

b

20.

1x 1x 7x 1x

11.

1x 1x 1x 1x

12.

3x

13.

9

12

14.

1x 1x 4x
4x 1x 2x 3x

21.

1x 1x 1x 1x 1x

22.

1x 1x 1x 1x 1x

23.

1x 1x 5x 1x

24.

19

23

25.

24

17

26.

8x 8x

8x

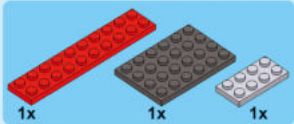
1. 

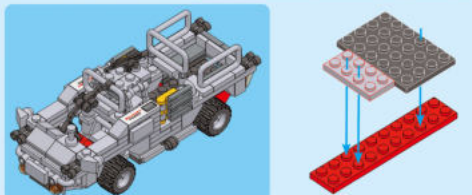

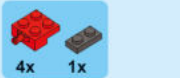
2. 

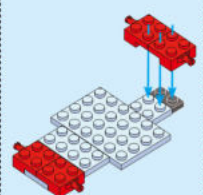

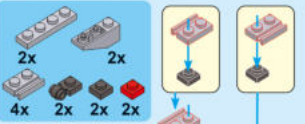
3. 

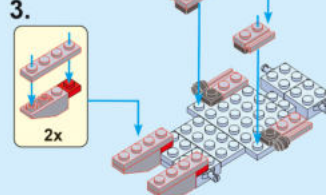

11. 



12. 

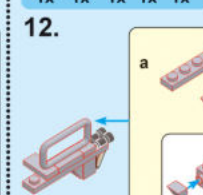

13. 

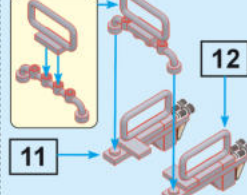

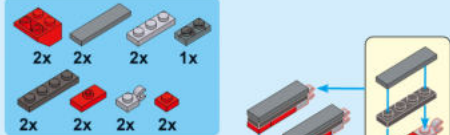
4. 

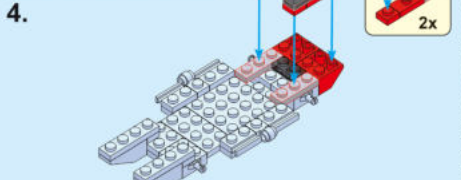

5. 

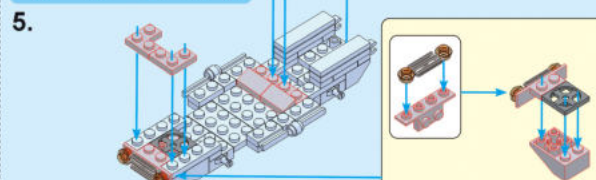

14. 

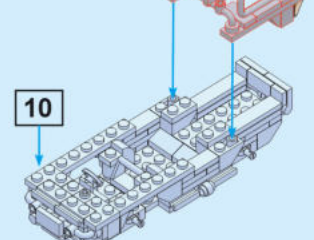

15. 

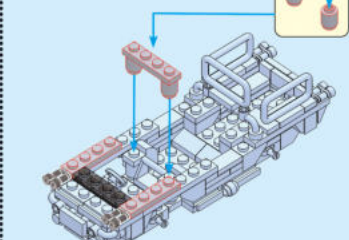

16. 

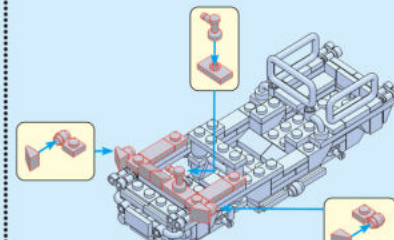

6. 

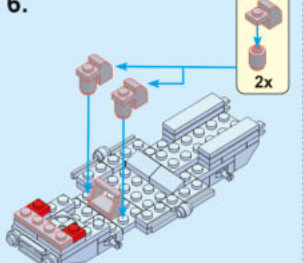

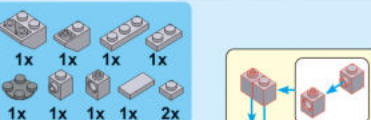
7. 

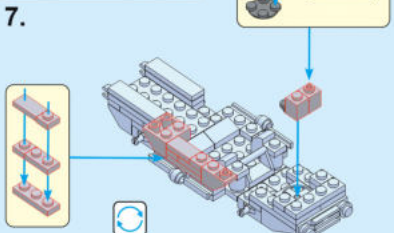

8. 

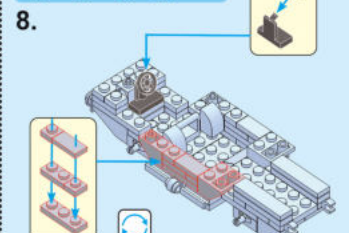

17. 

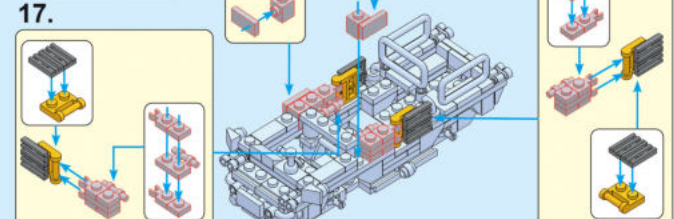

18. 

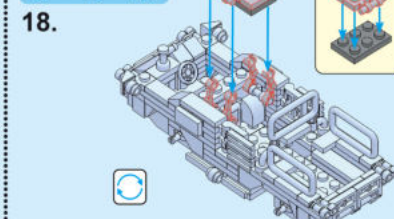

9. 

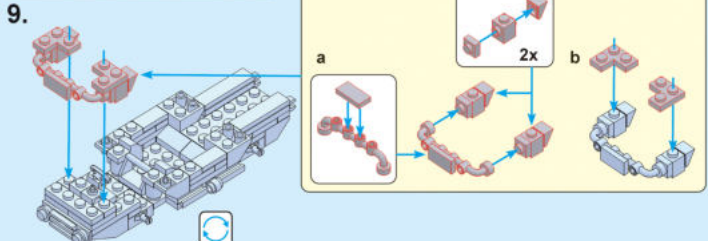

10. 

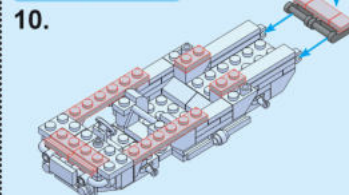

19. 

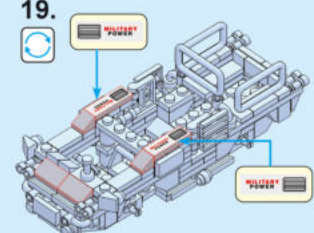

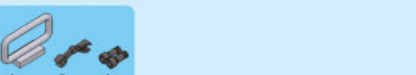
20. 

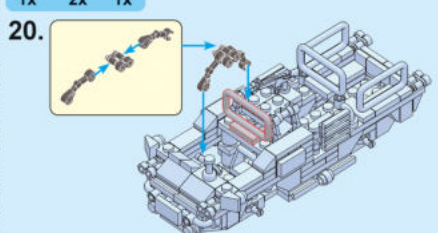

21. 