

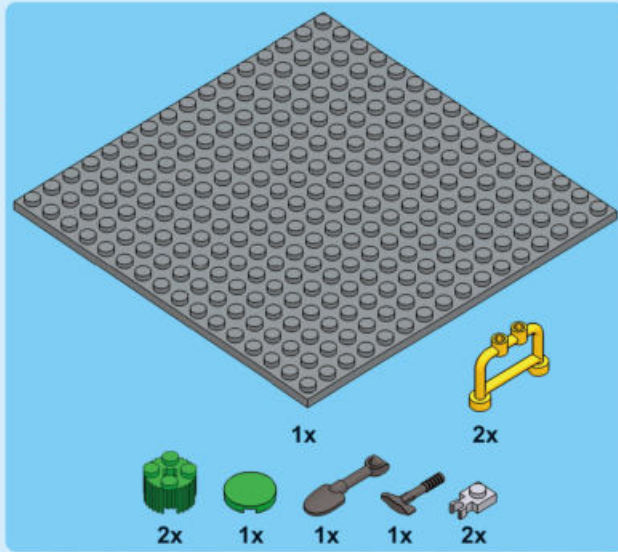

1

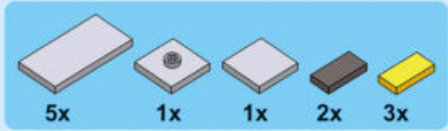

1.

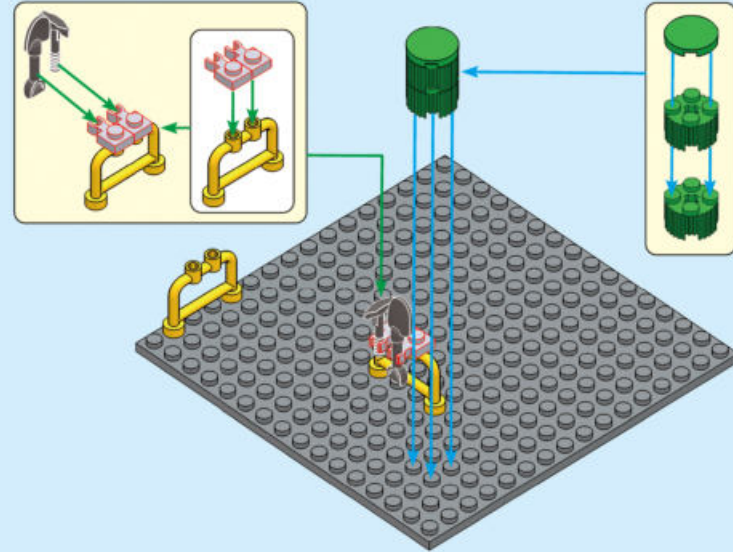

2.

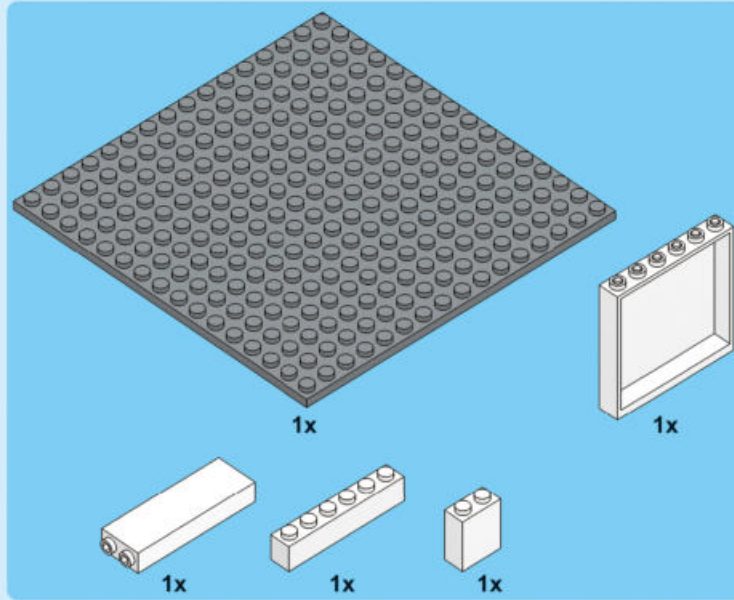
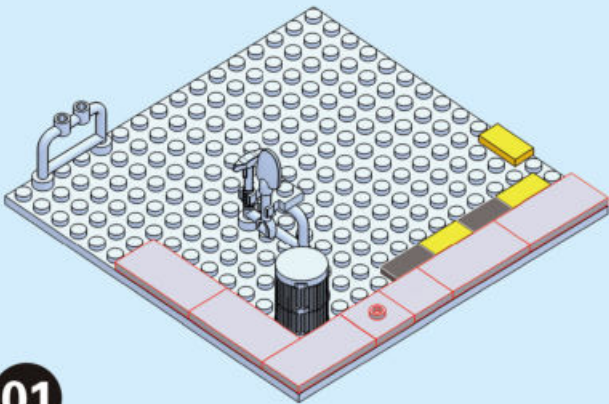

3.

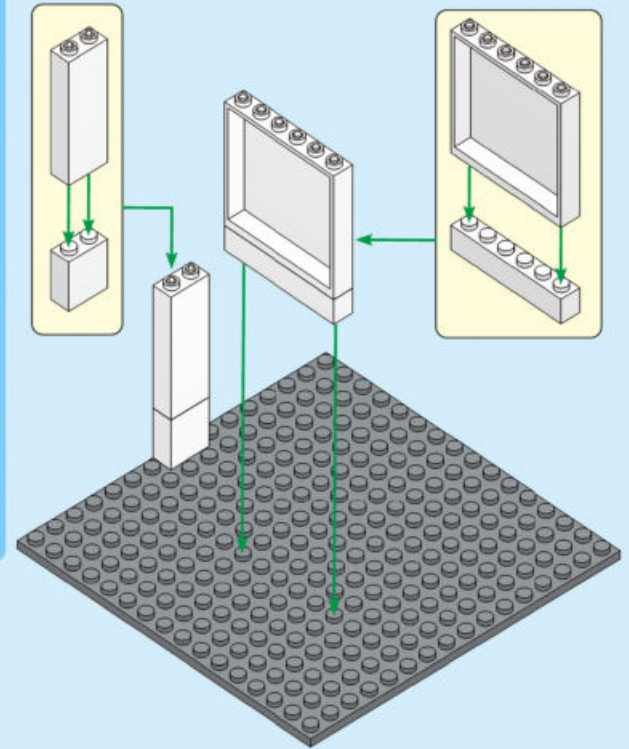

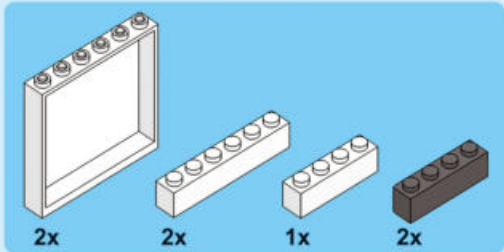

4.

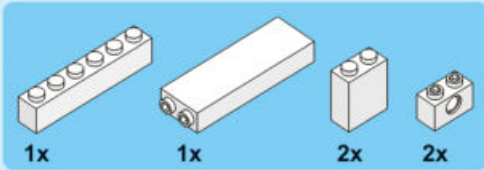
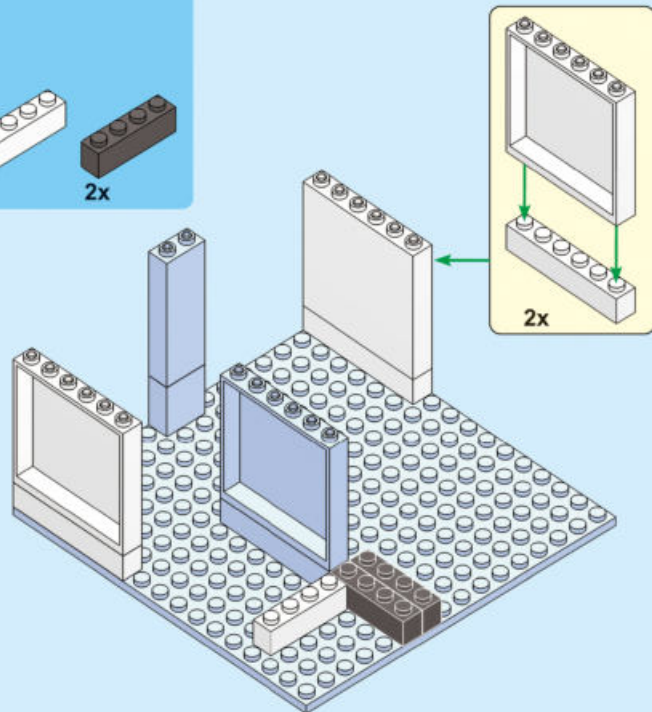

5.

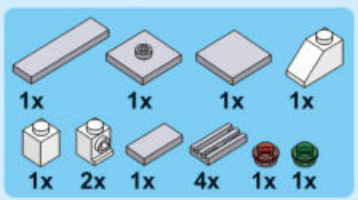
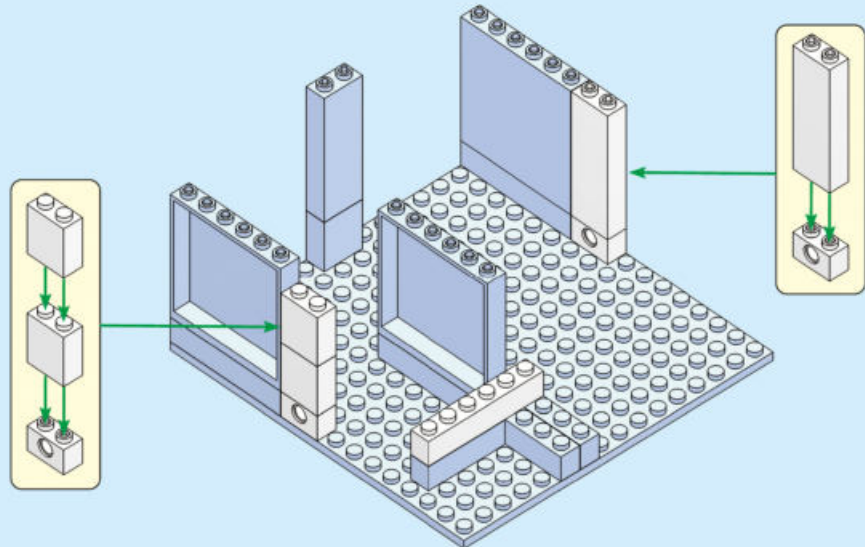

6.

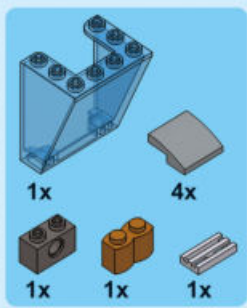
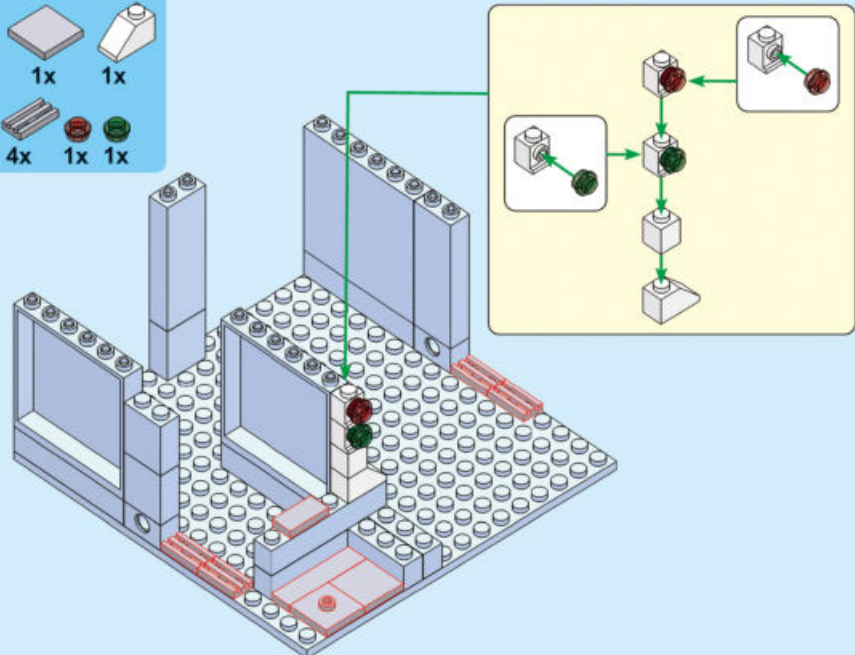

7.

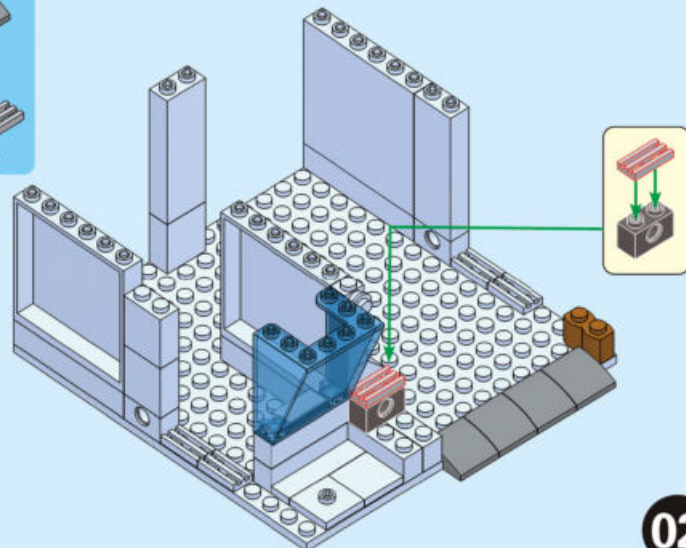



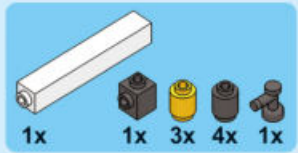

8.

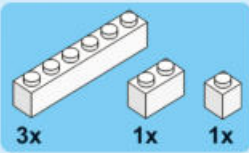
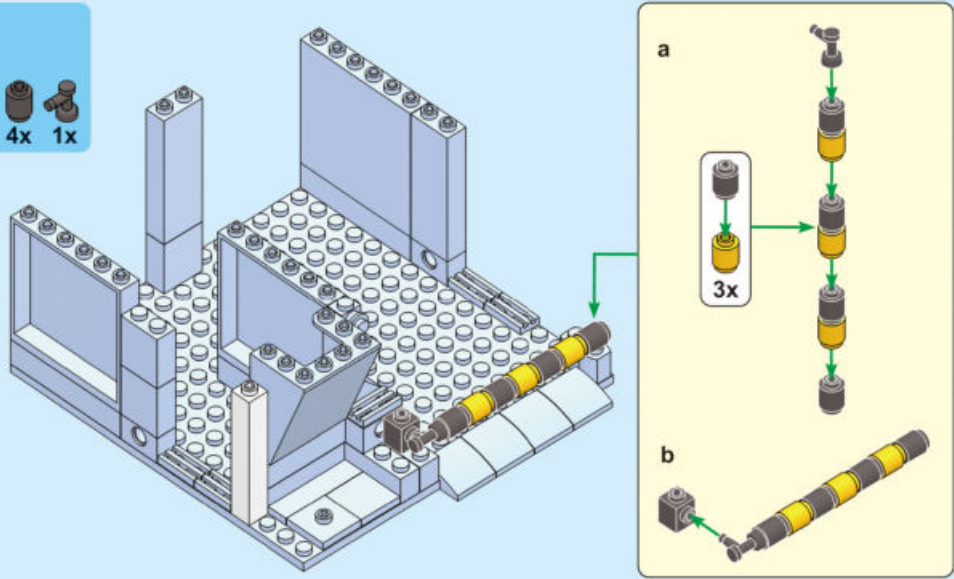

9.

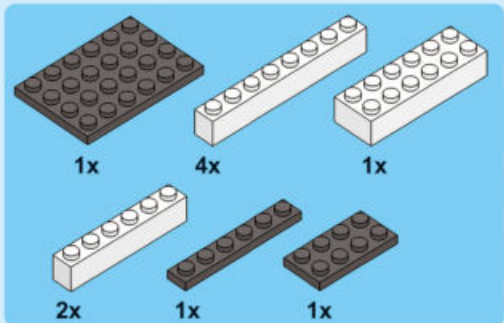
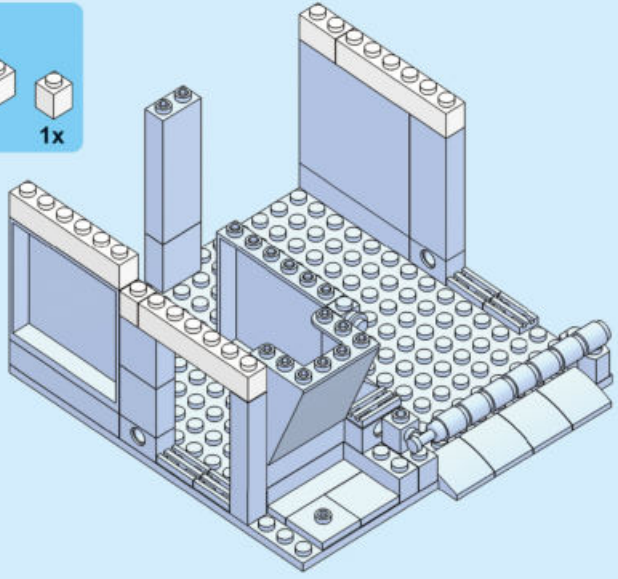

10.

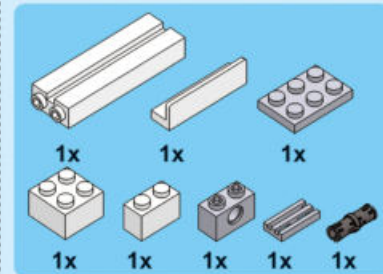
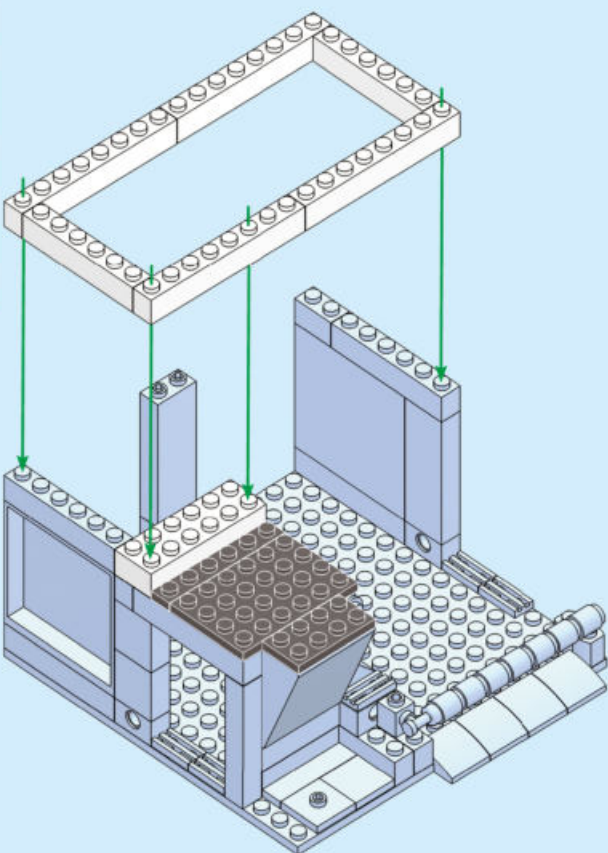

11.

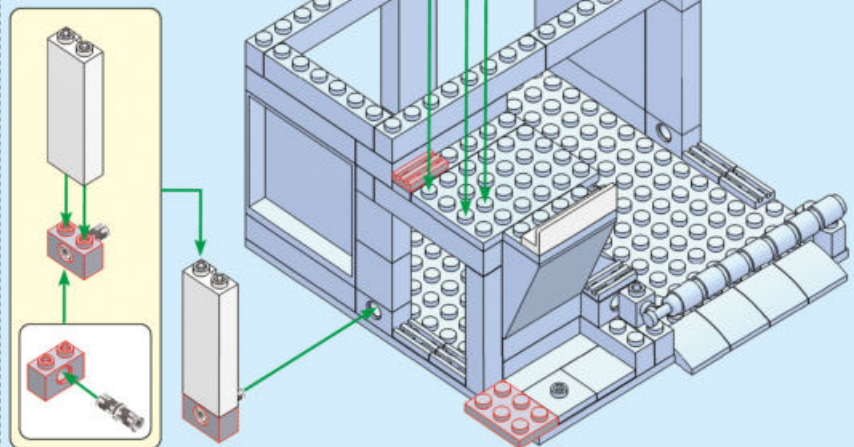

12.

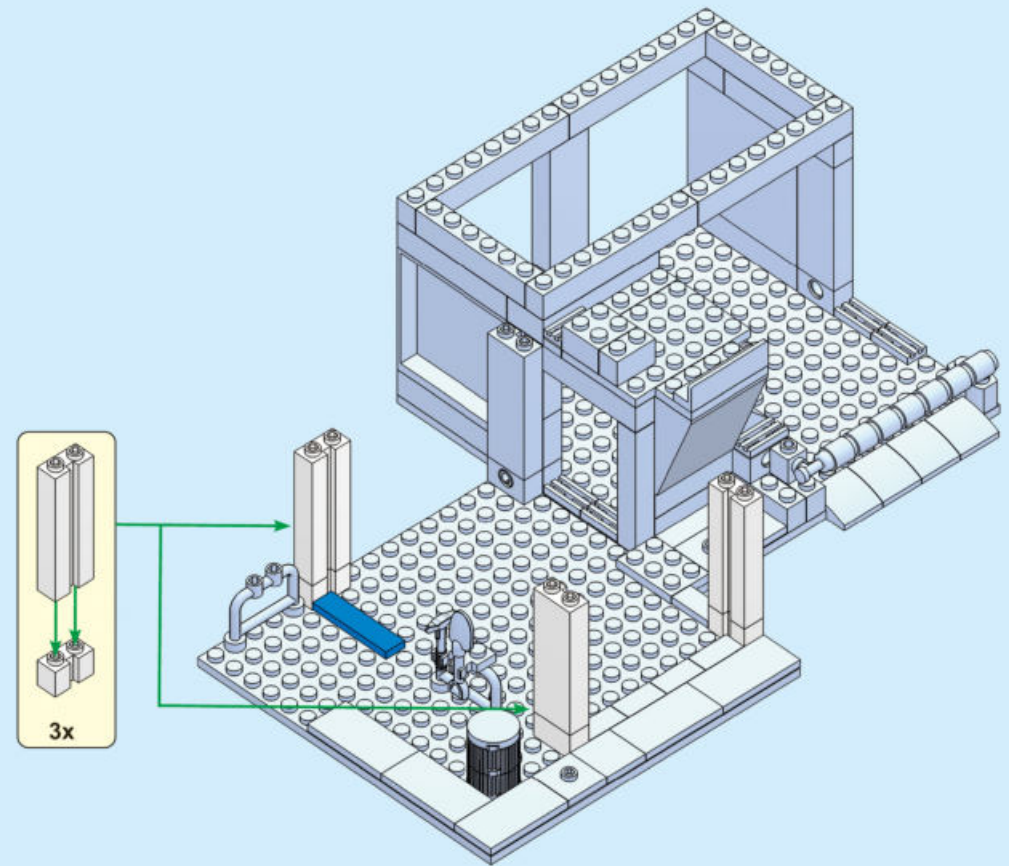
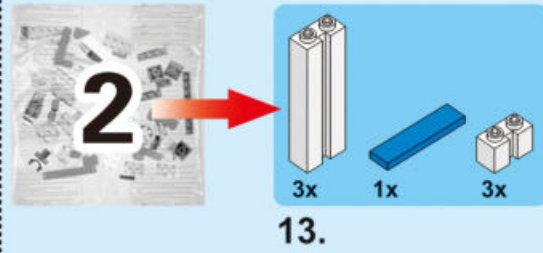
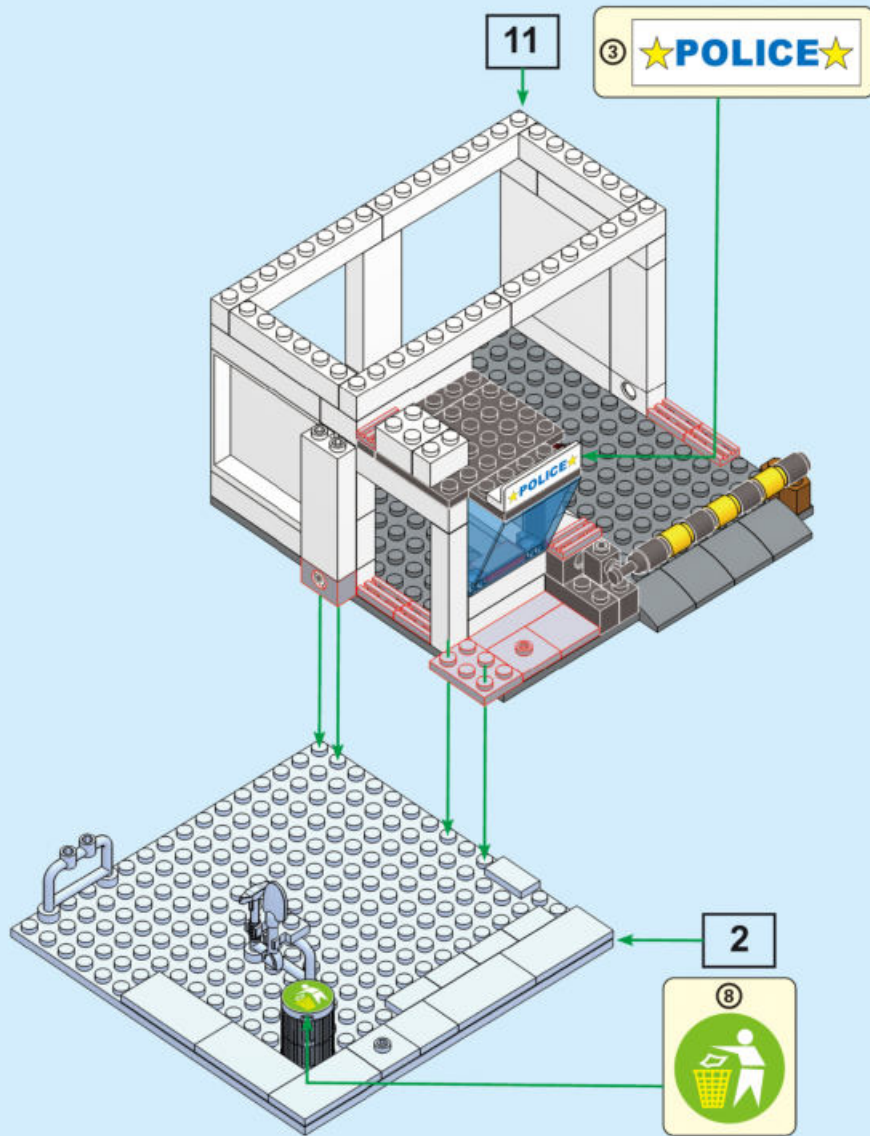



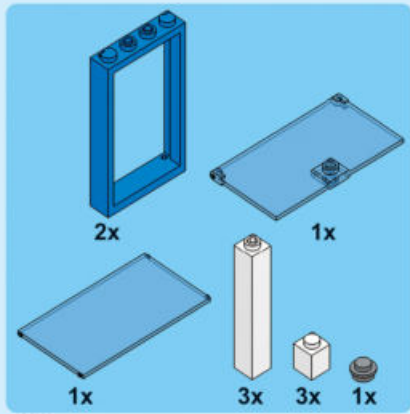

14.

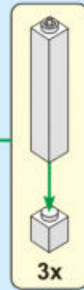
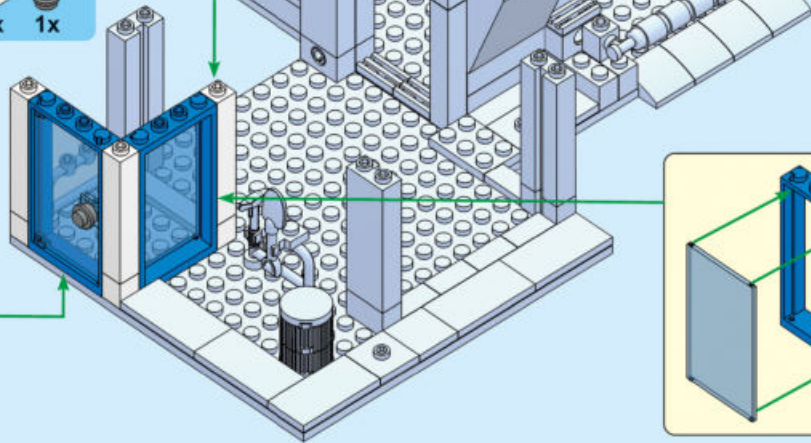
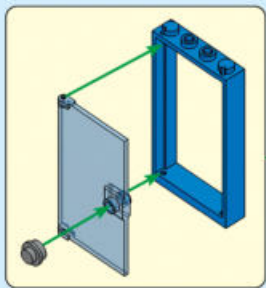

3x

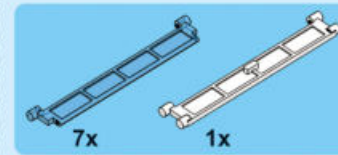

15.

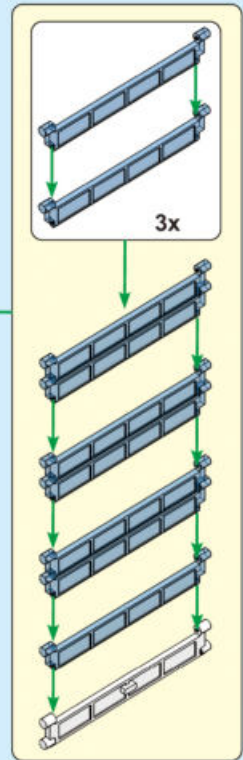
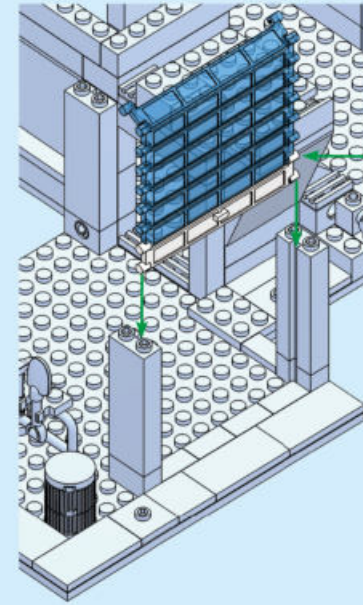

3x

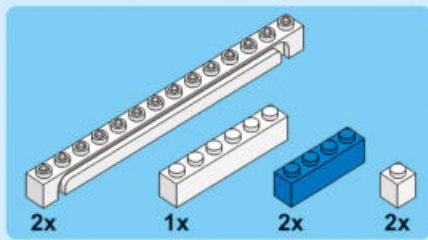

16.

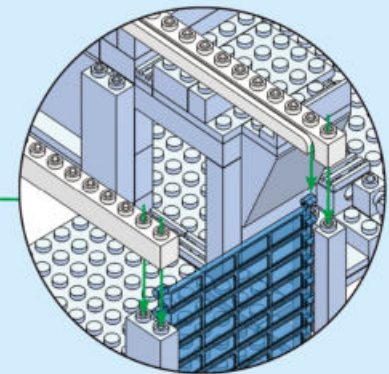
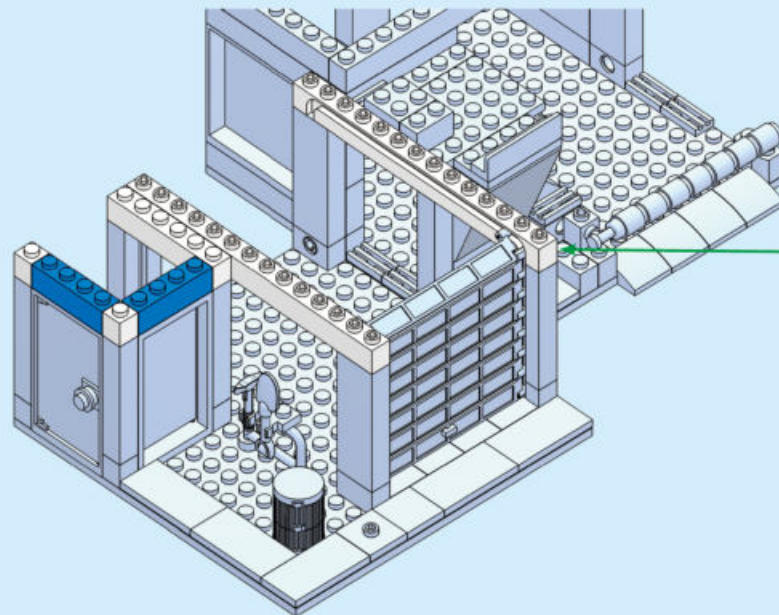







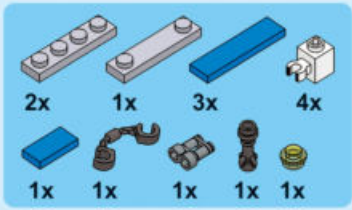

21.

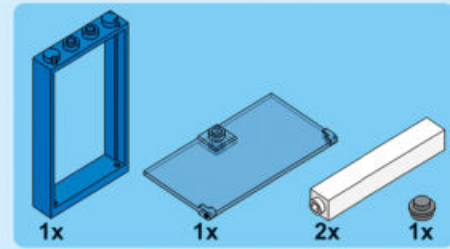
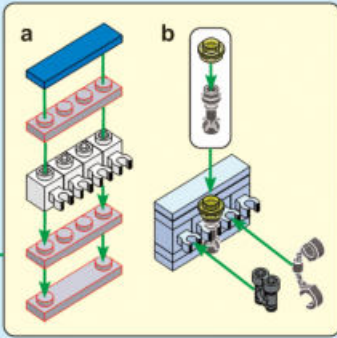
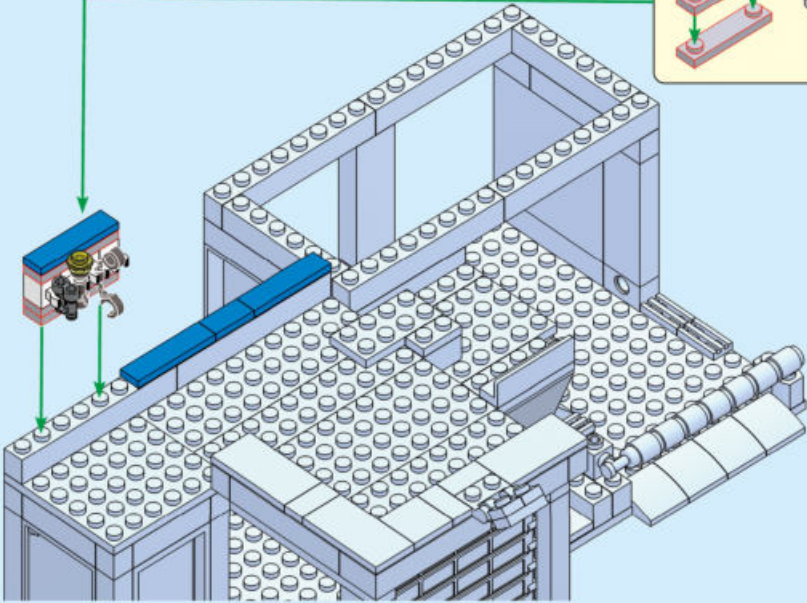

22.

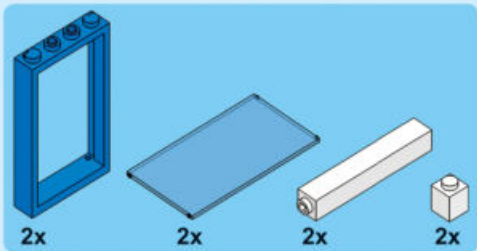
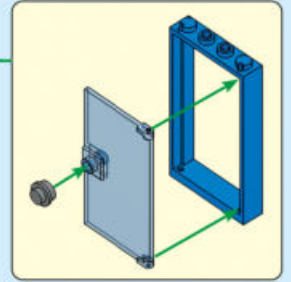
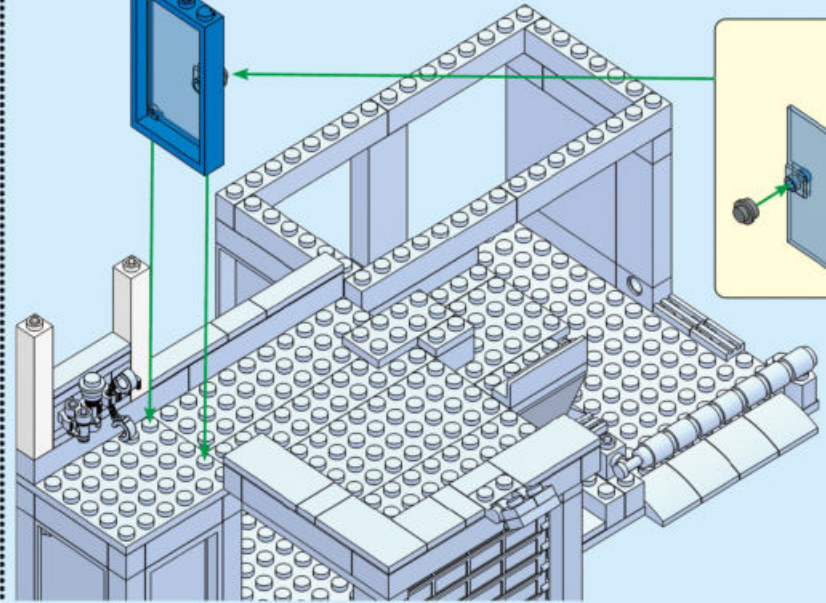

23.

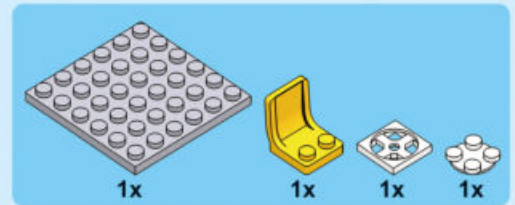
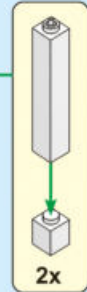
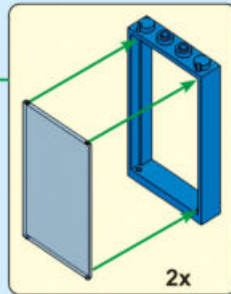
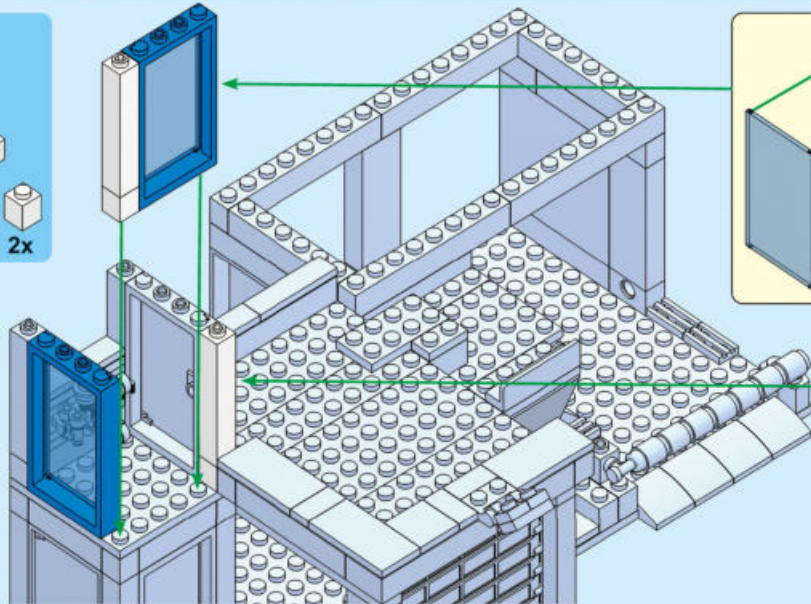

24.

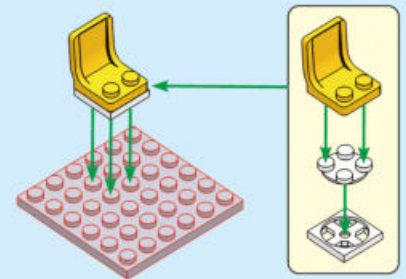



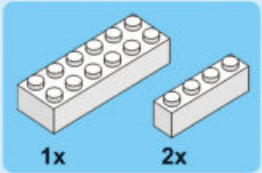

25.

1x 2x

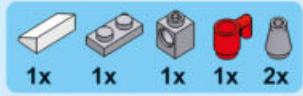
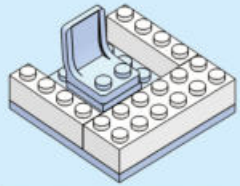

26.

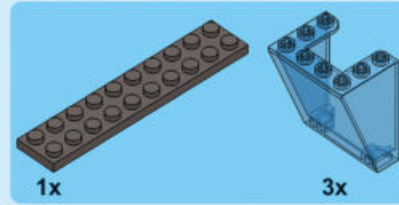
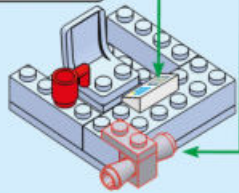
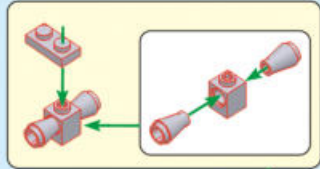

27.

1x 3x

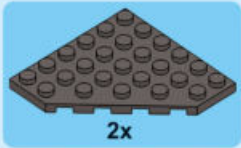
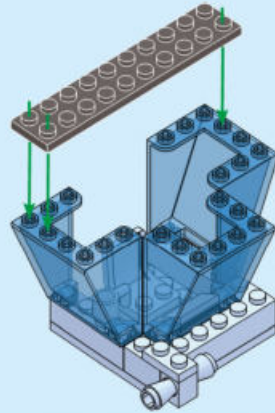

28.

2x

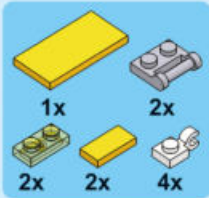
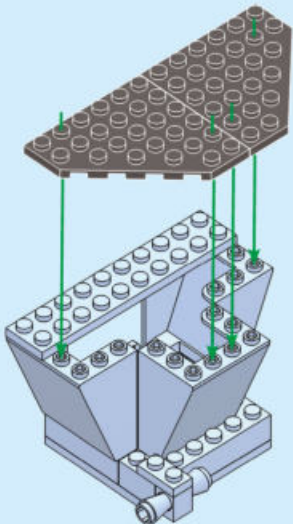

29.

1x 2x  
2x 2x 4x

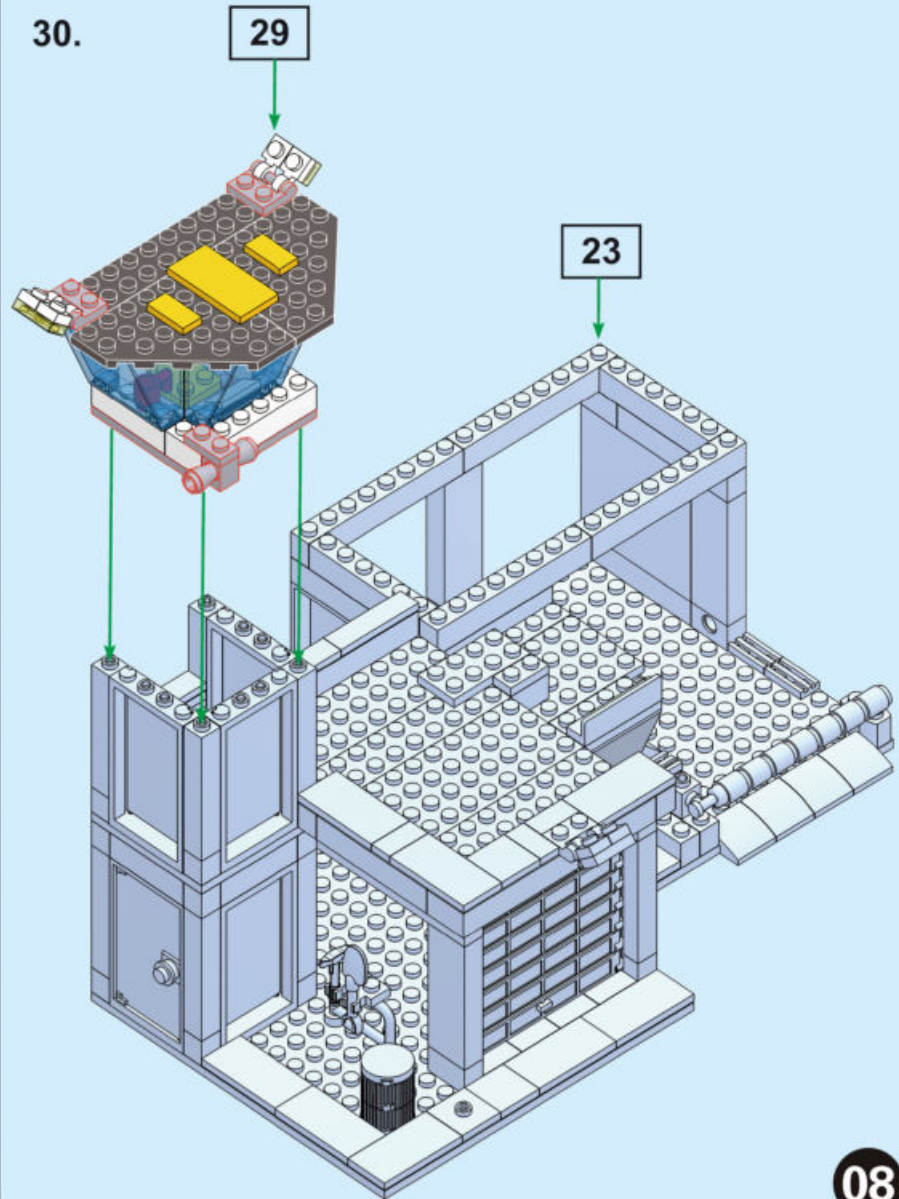
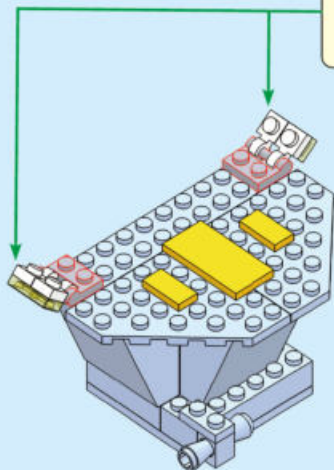
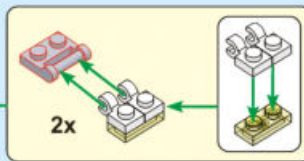

30.

29

23



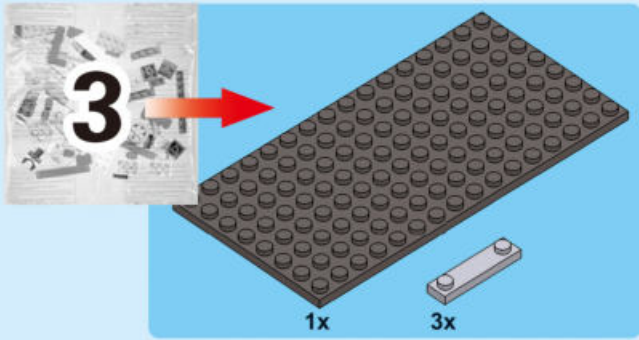

31.

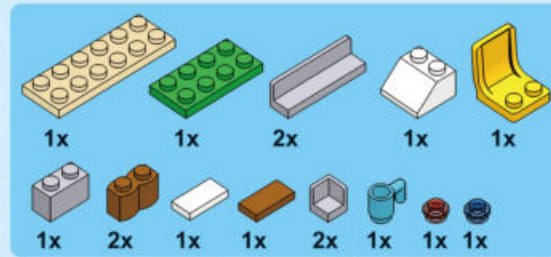
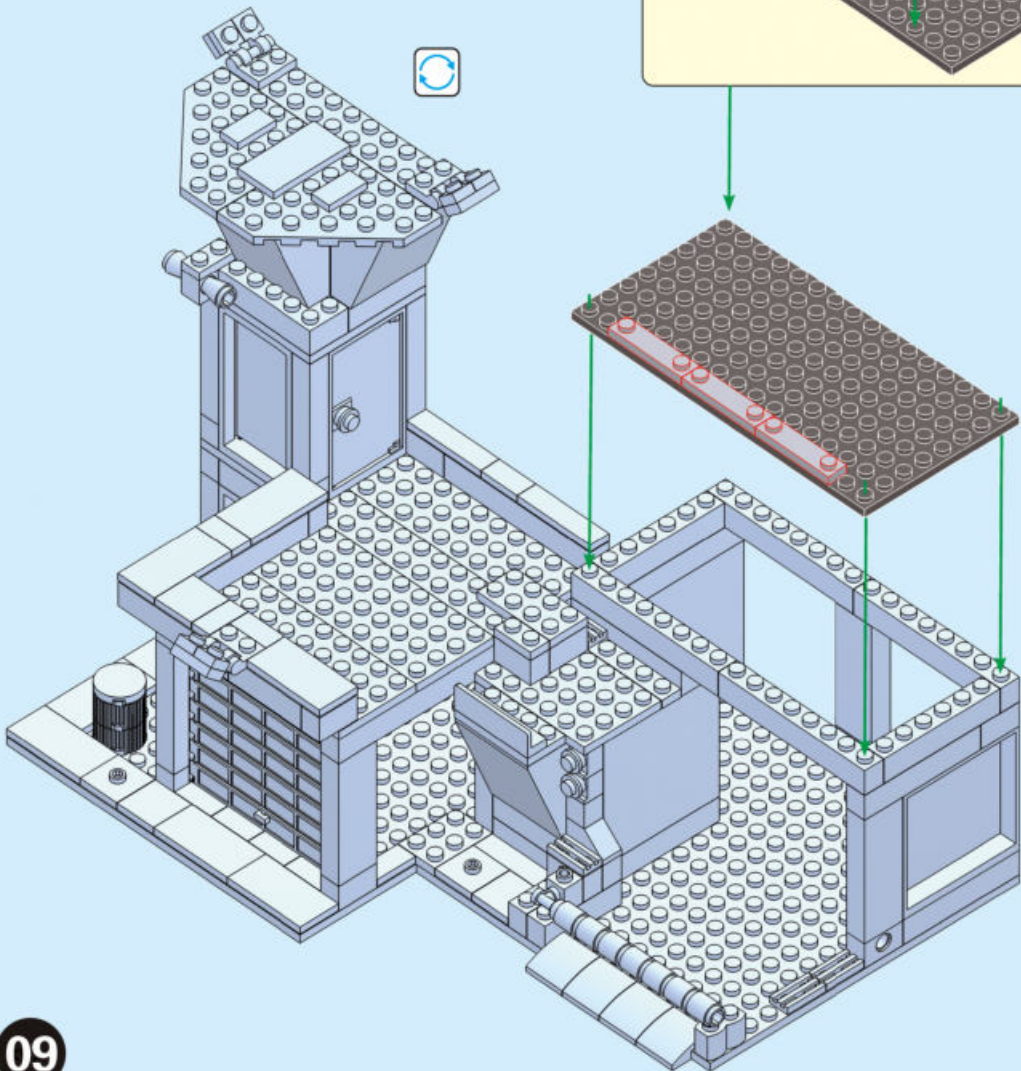
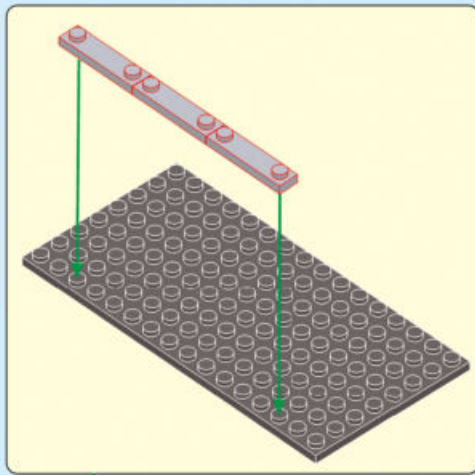

32.

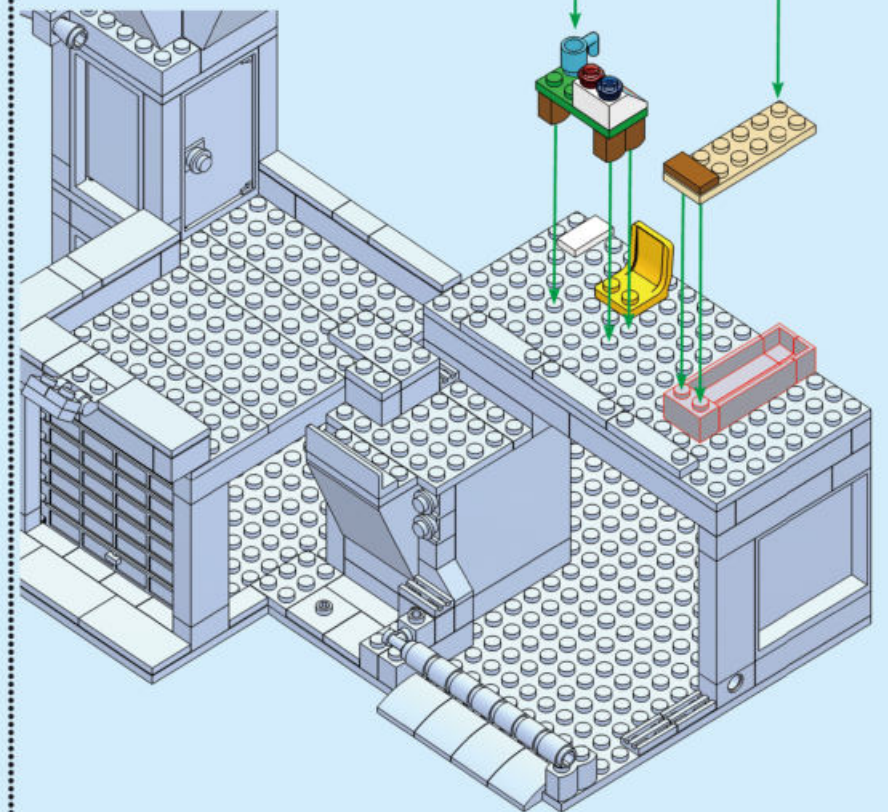
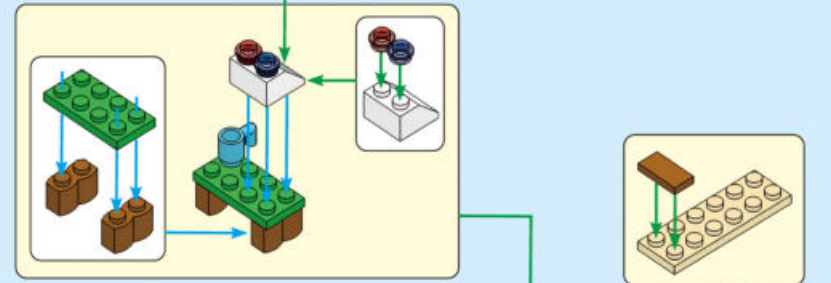
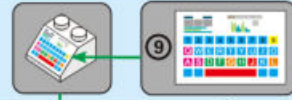



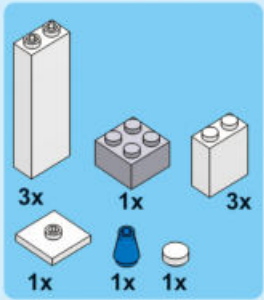

33.

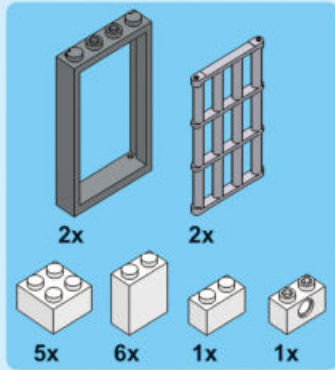
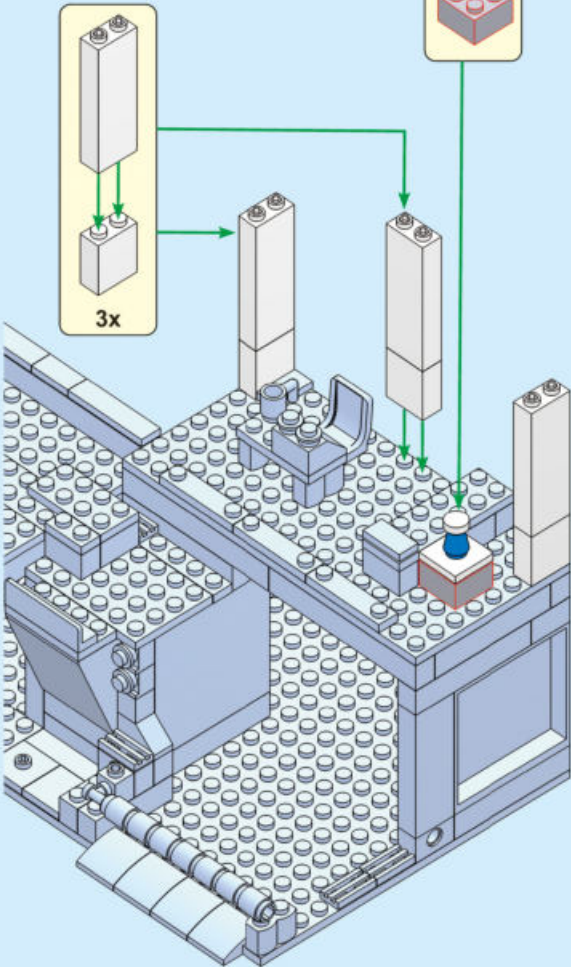
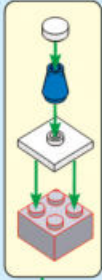

34.

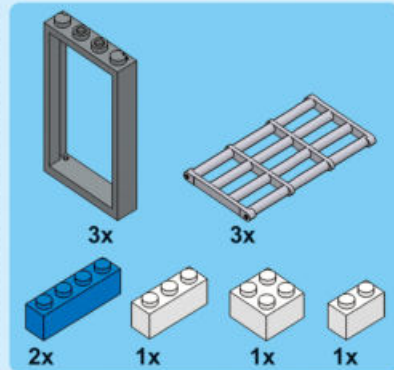
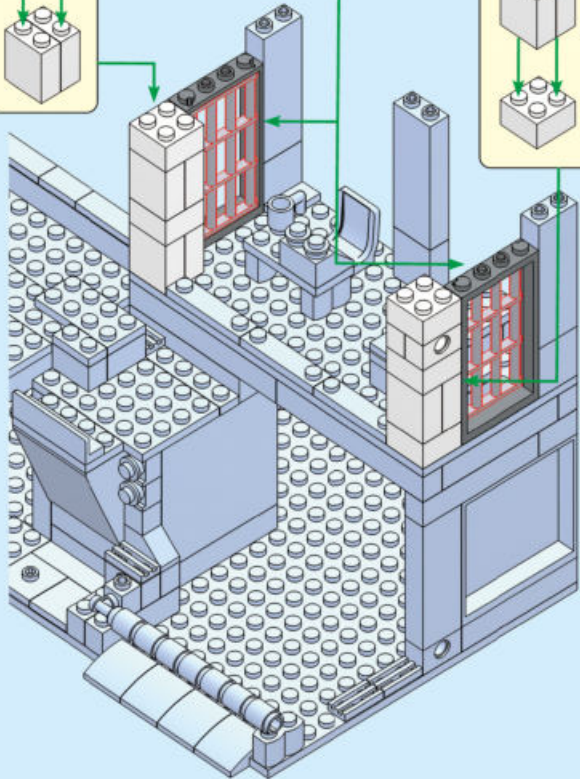
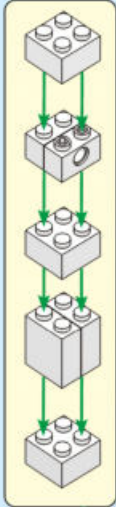
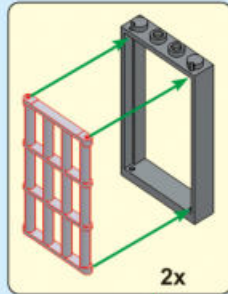
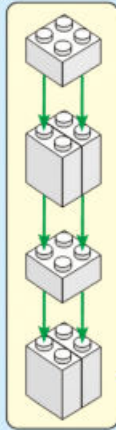

35.

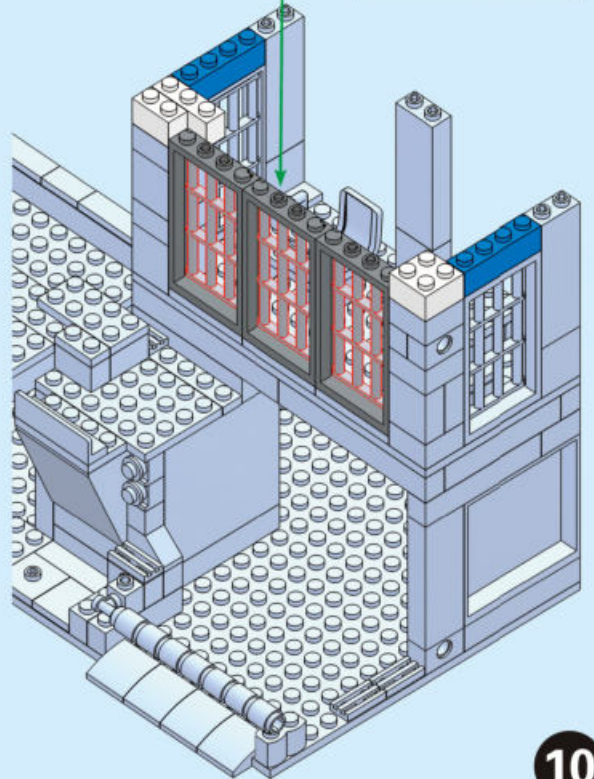
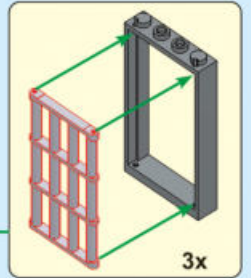



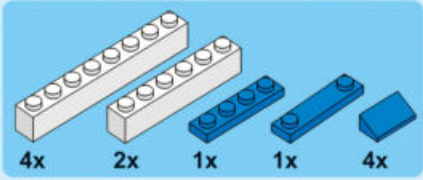

36.

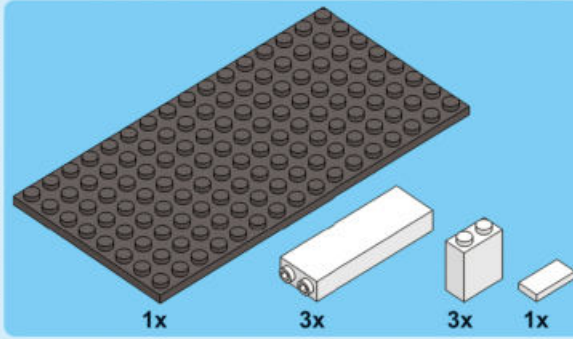
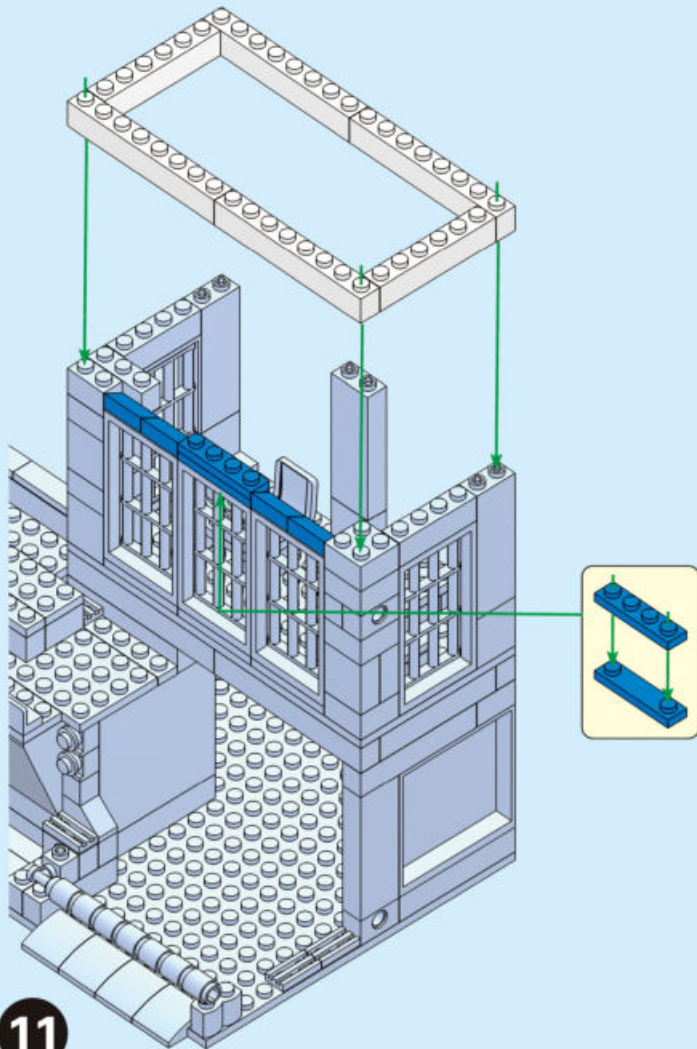

37.

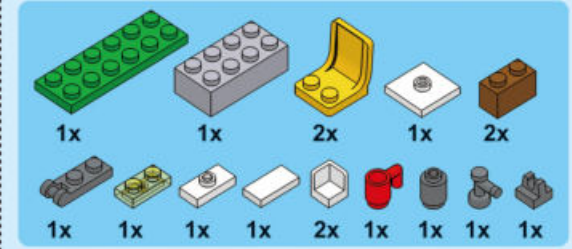
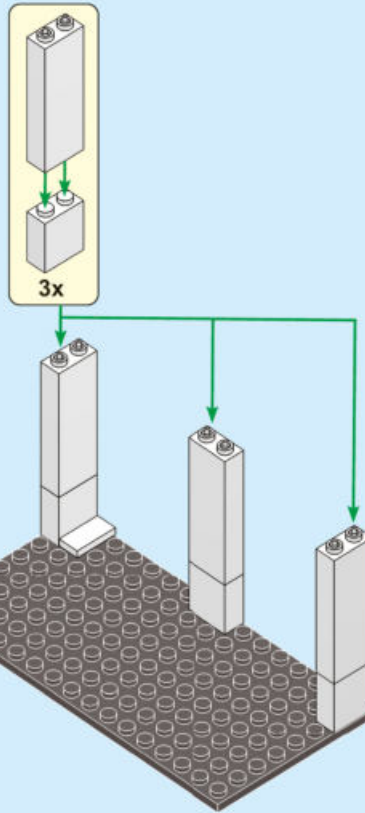

38.

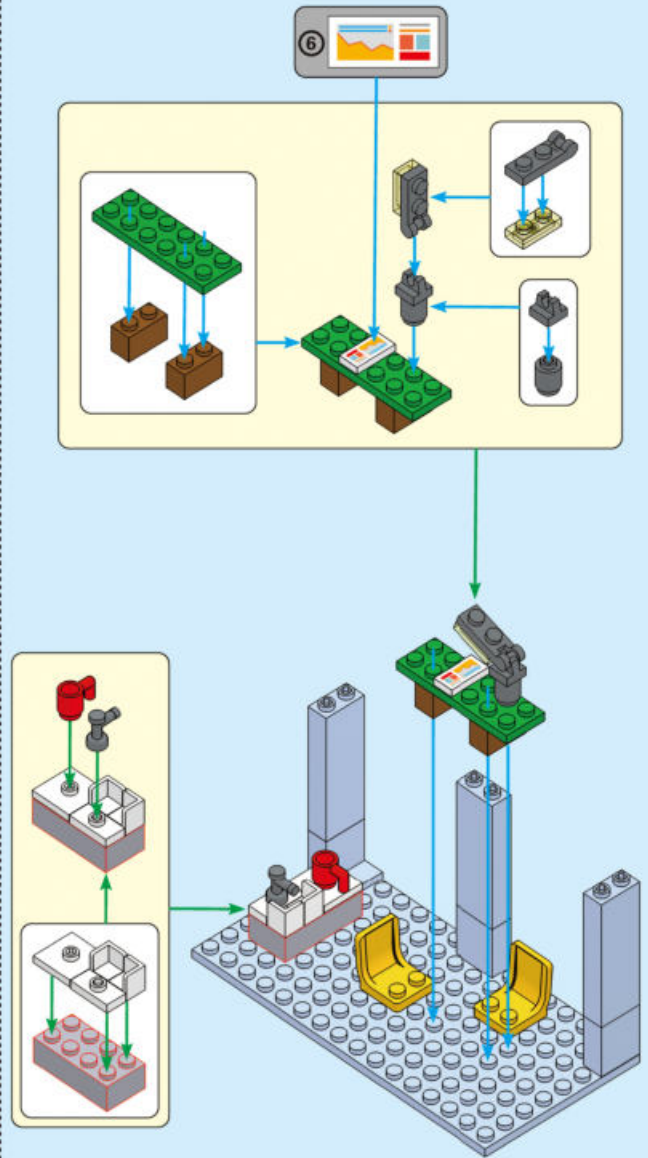

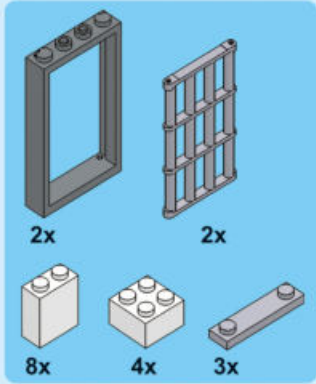

39.

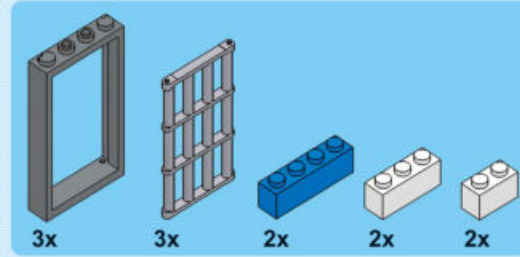
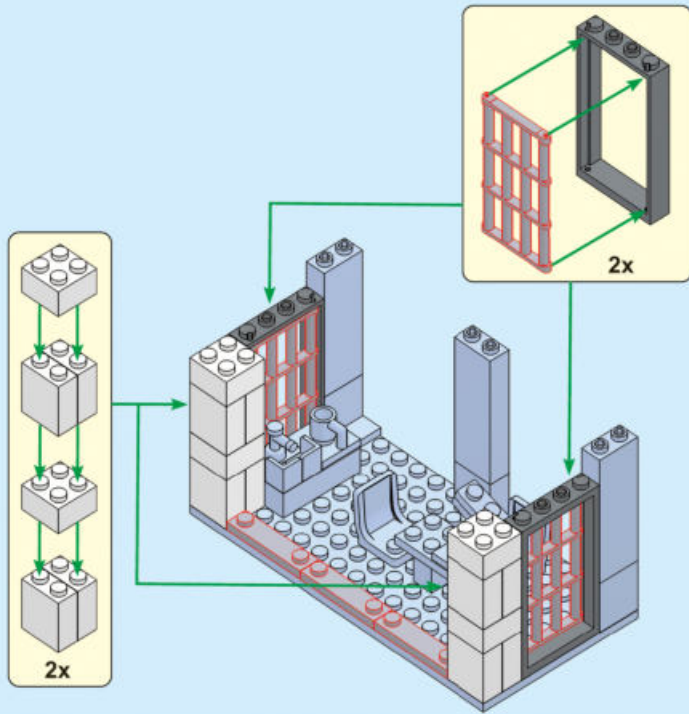

40.

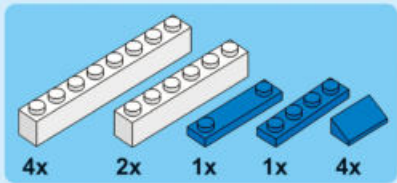
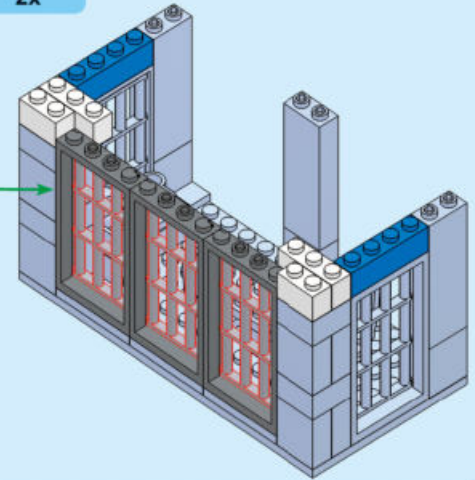
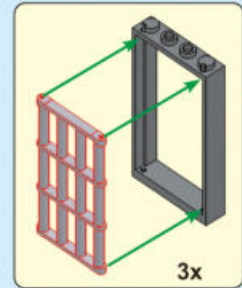

41.

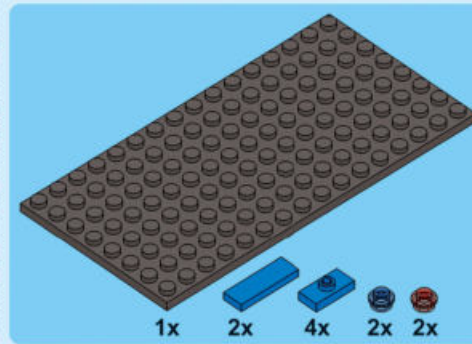
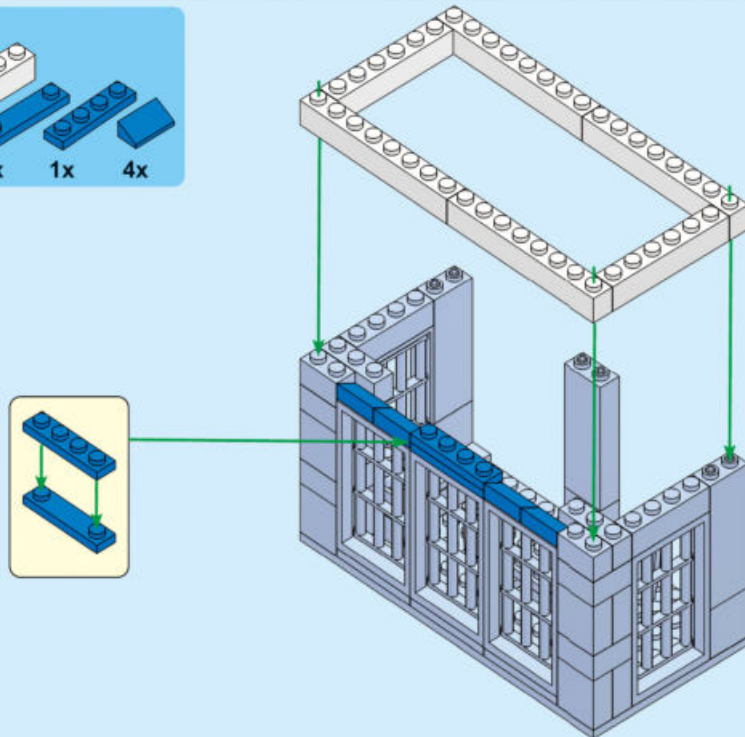

42.

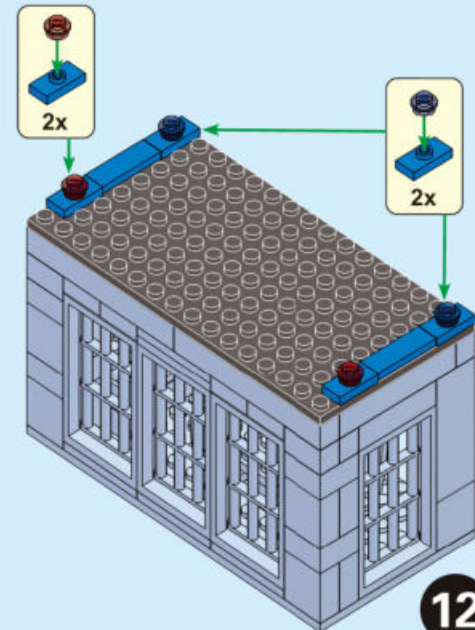



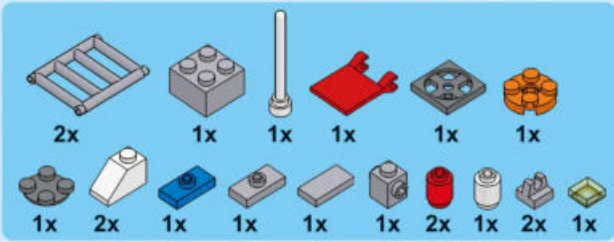

43.

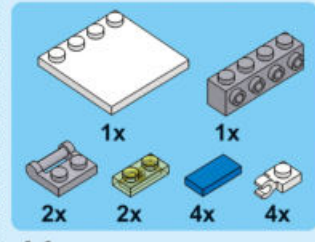
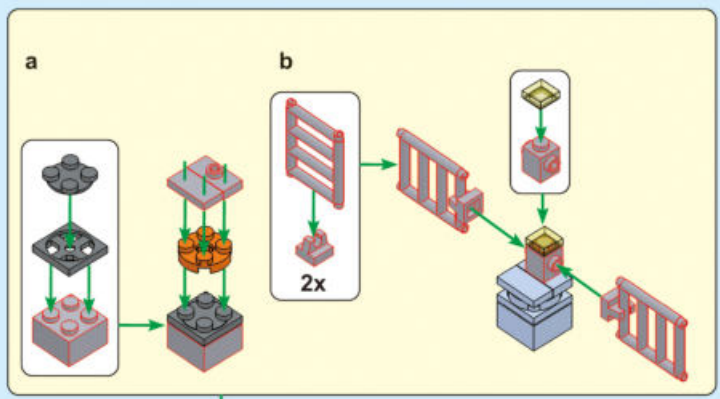

44.

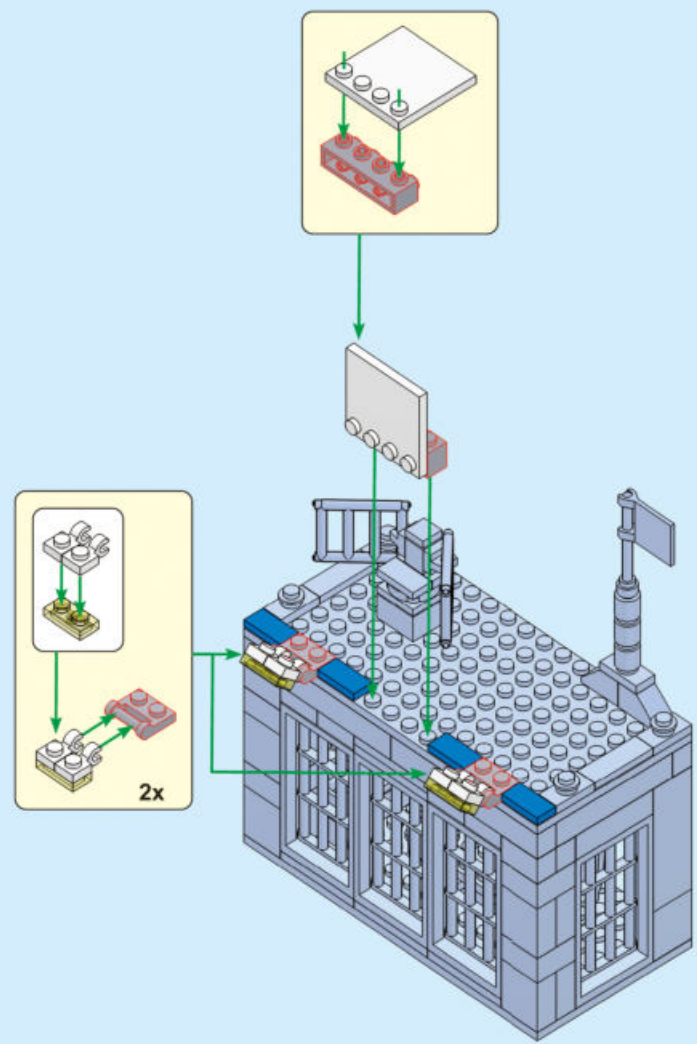

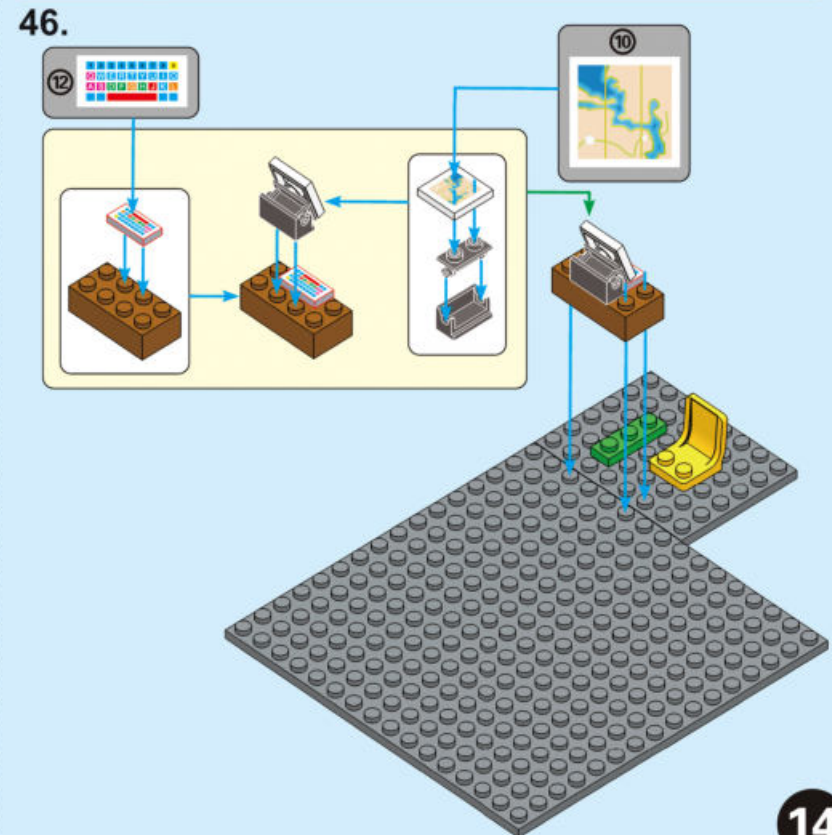
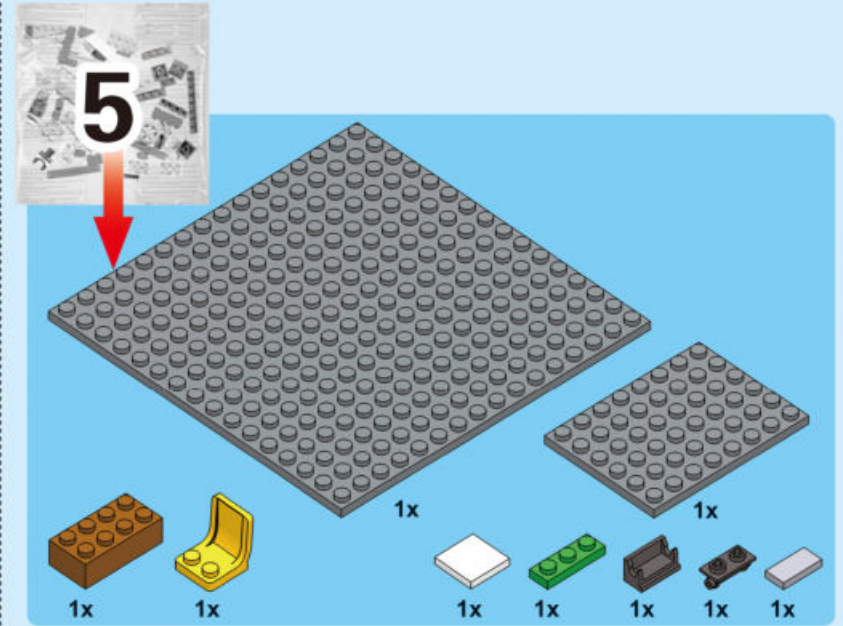
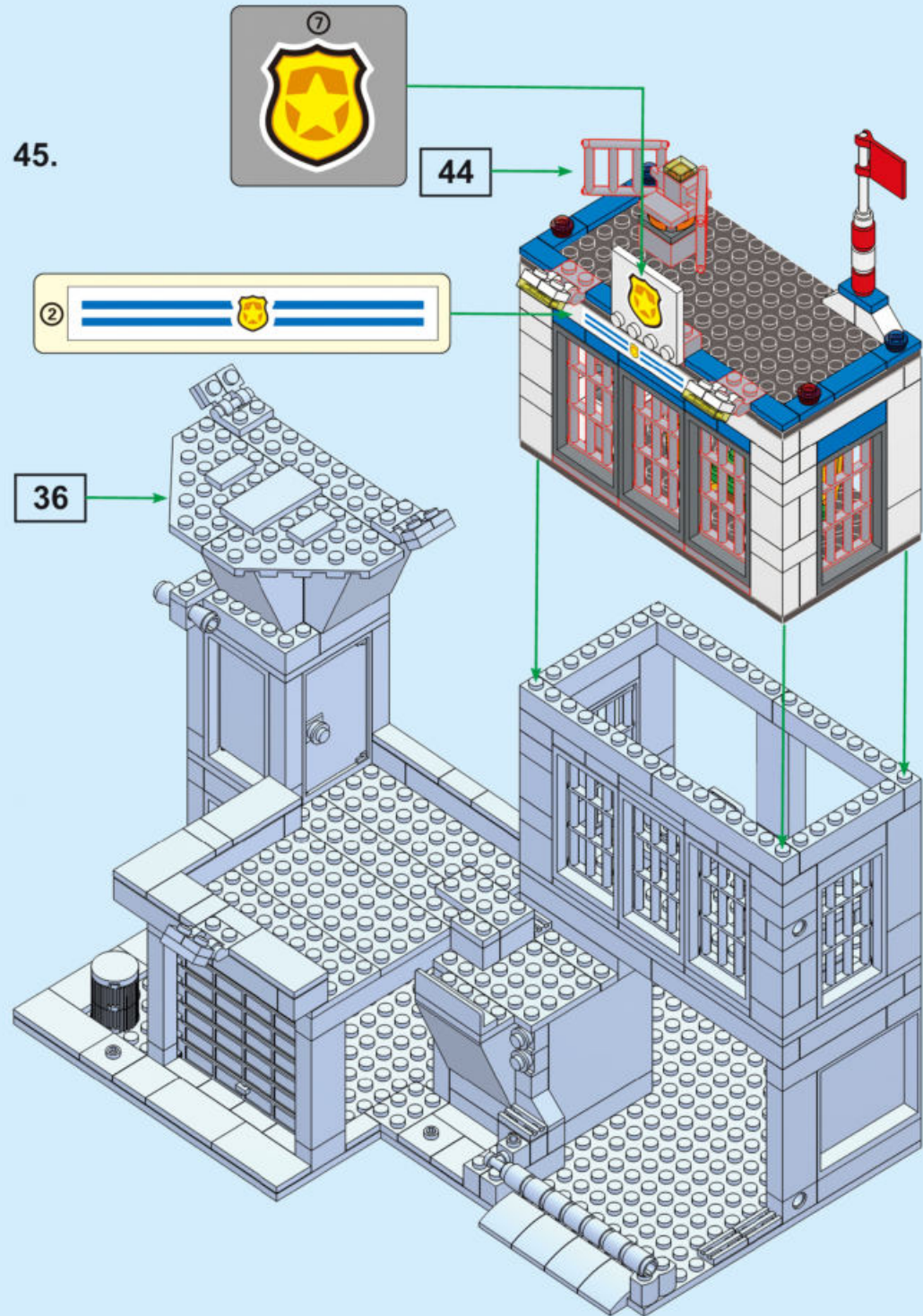



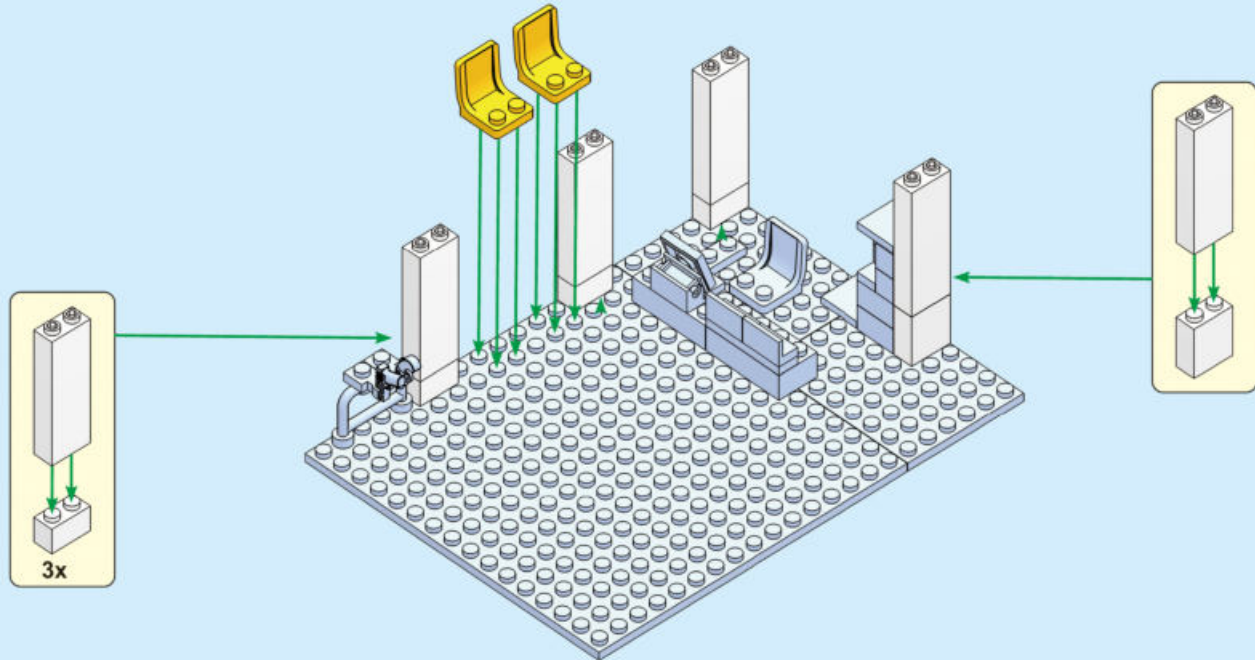
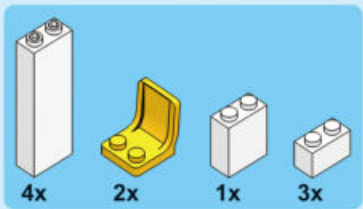
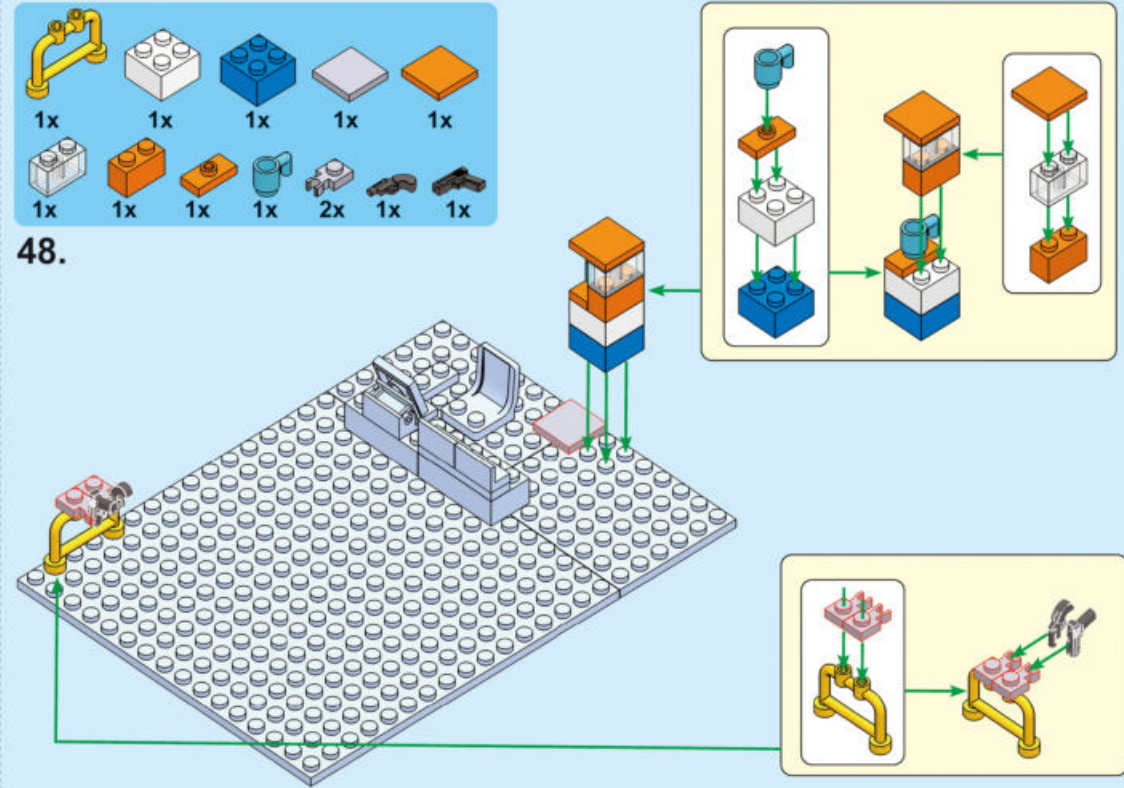
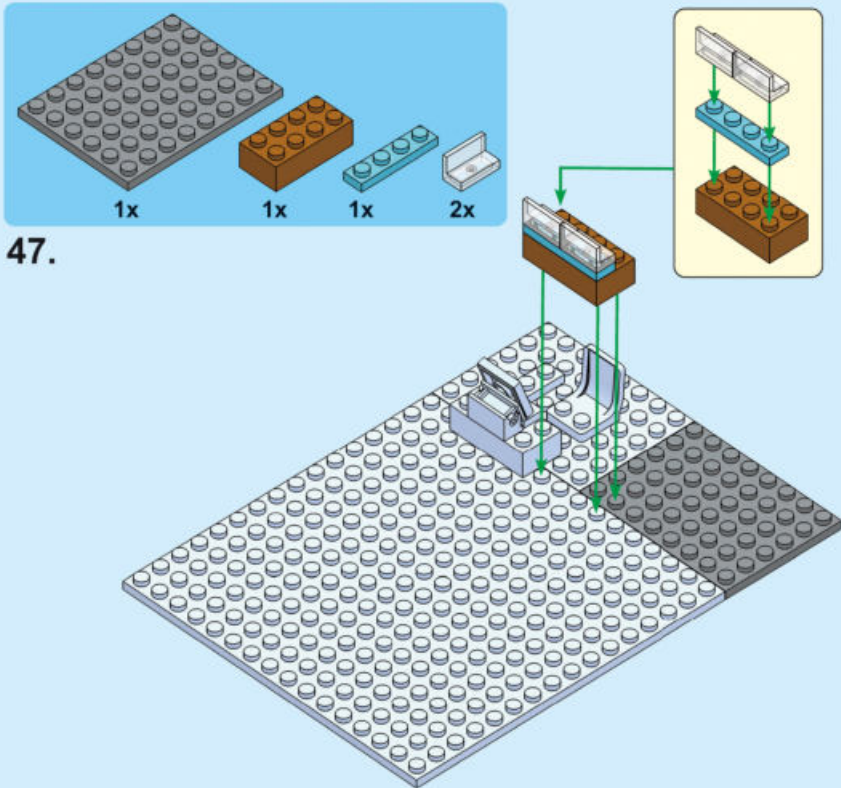

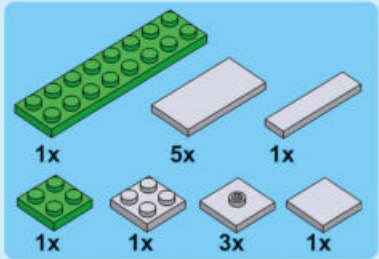

50.

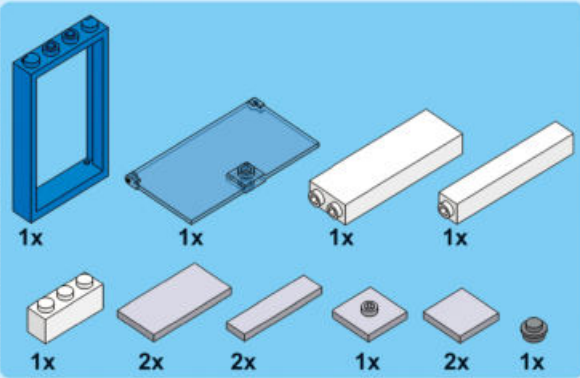
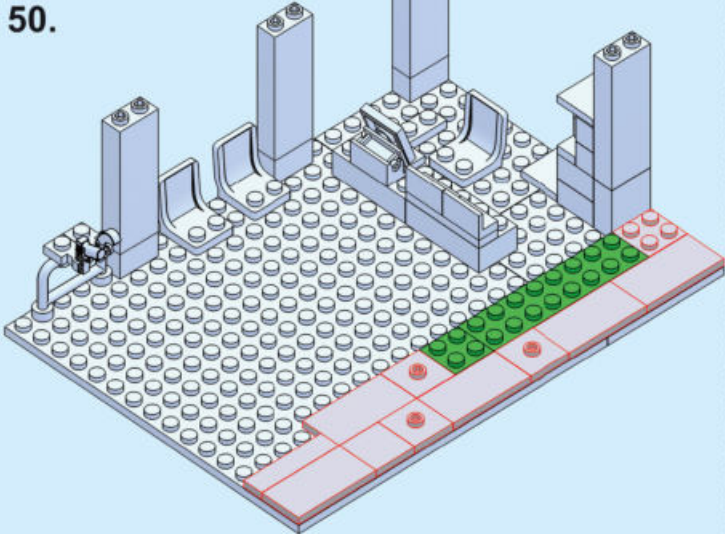

51.

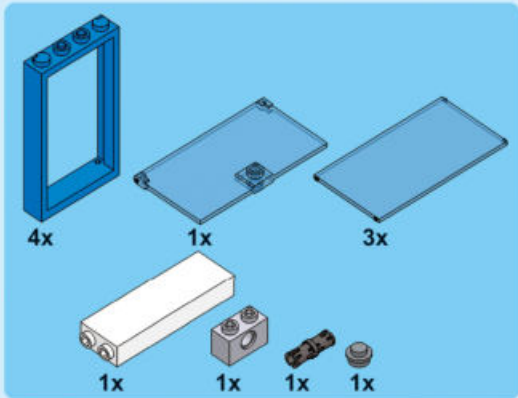
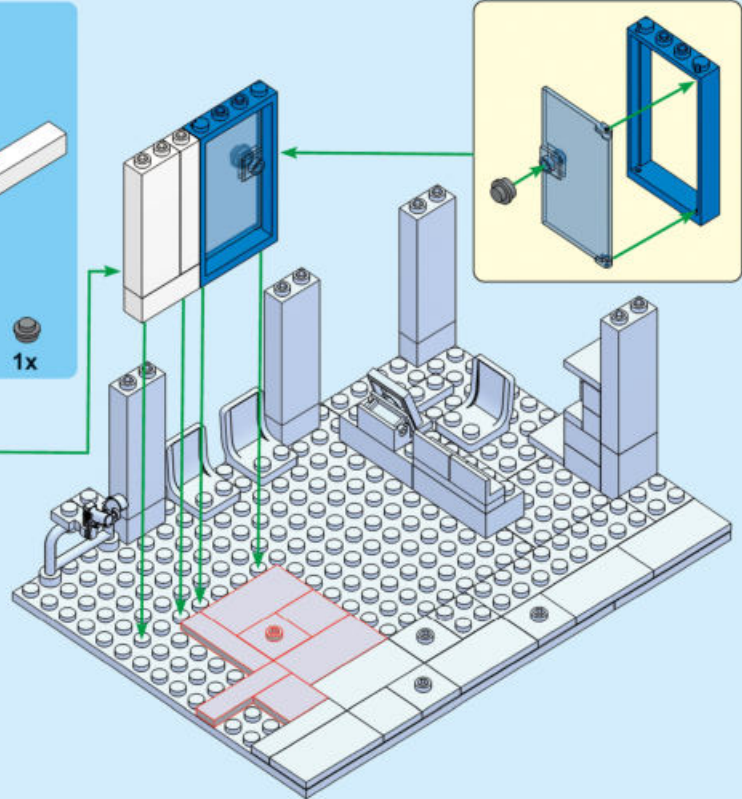
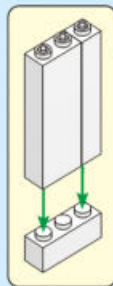

52.

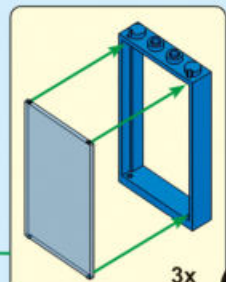
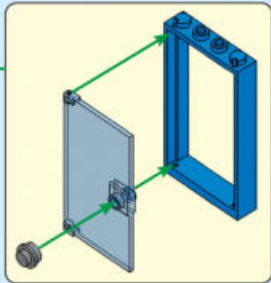
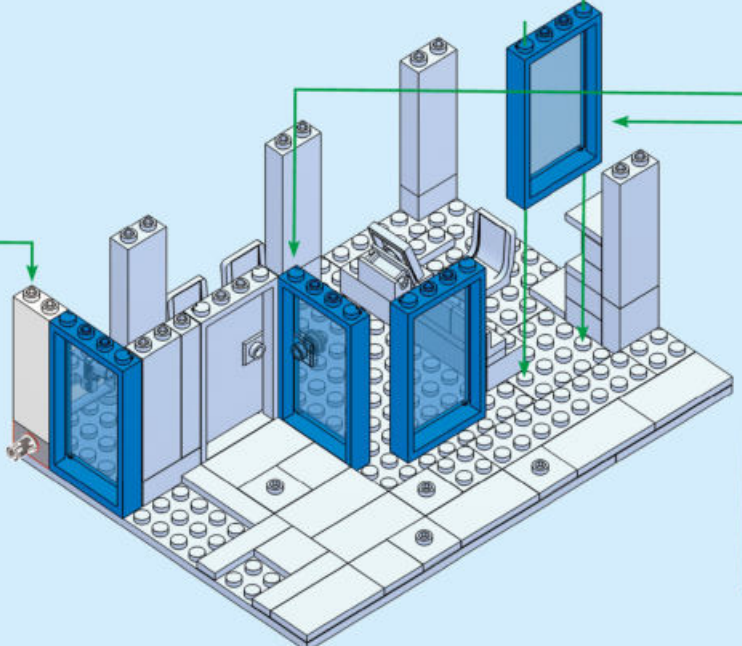
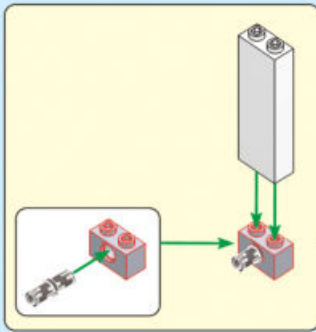

3x



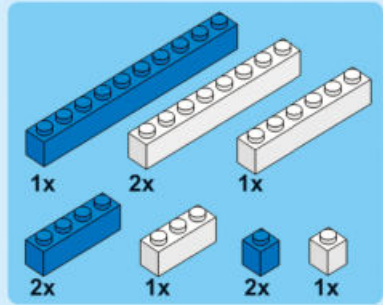

53.

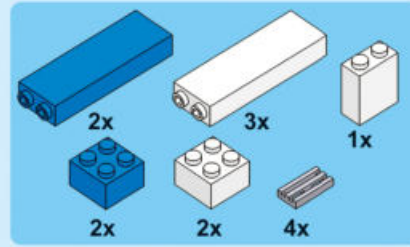
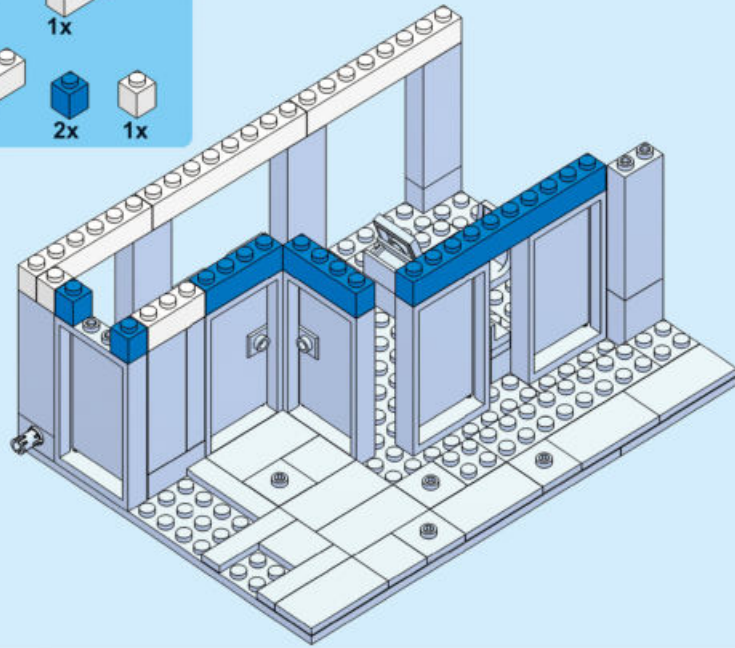

54.

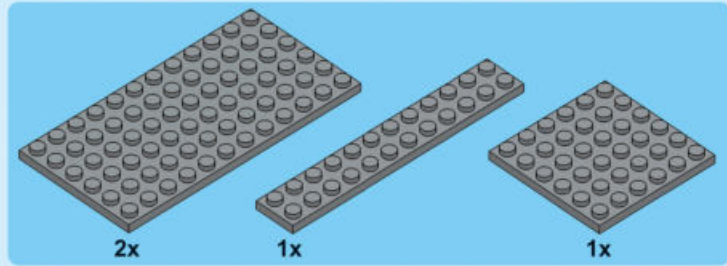
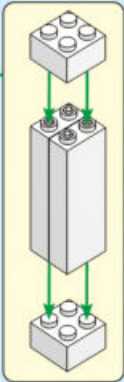
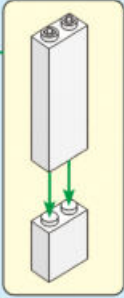
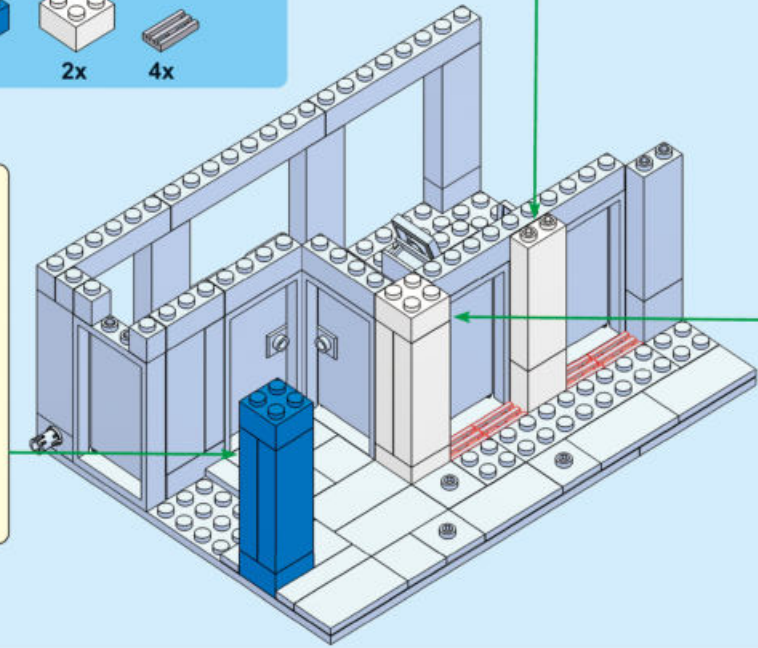
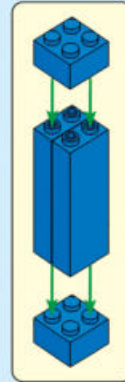

55.

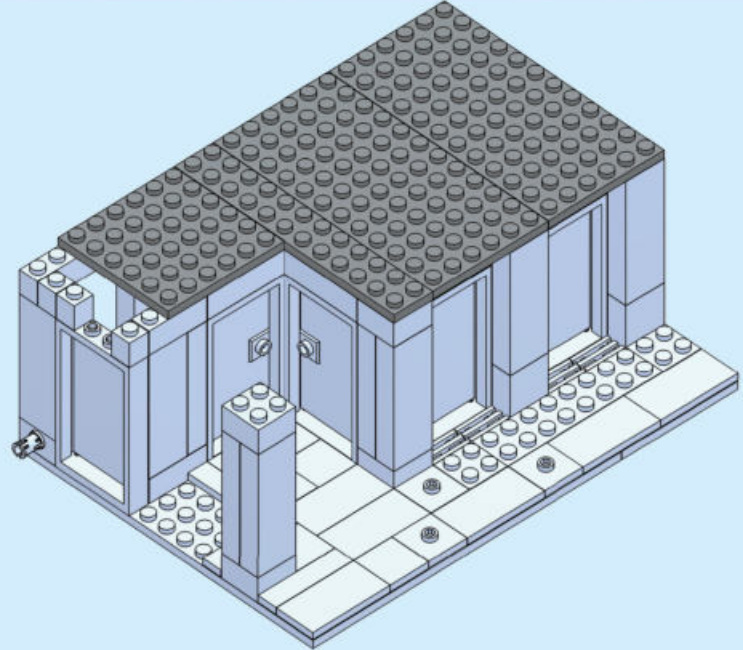

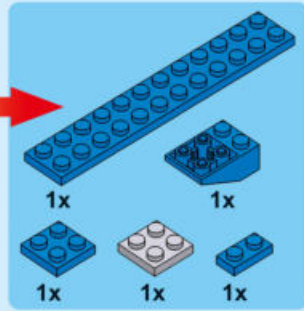

56.

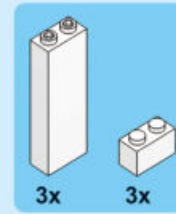
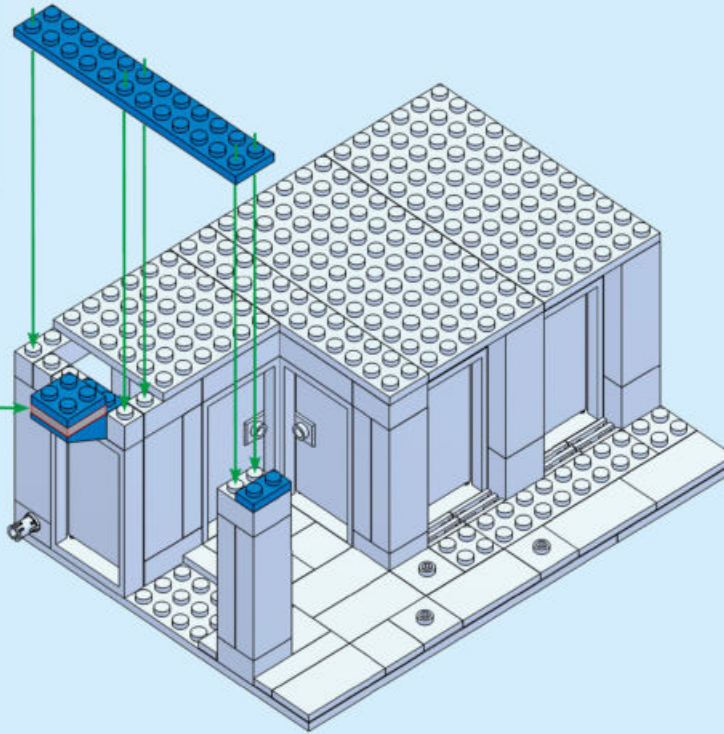
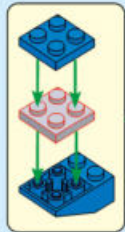

57.

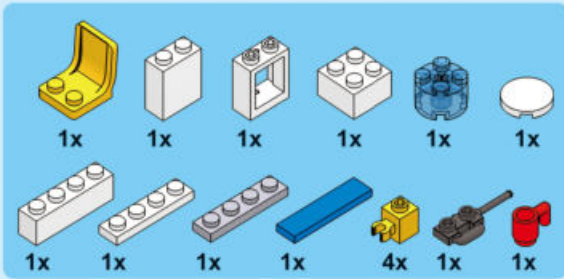
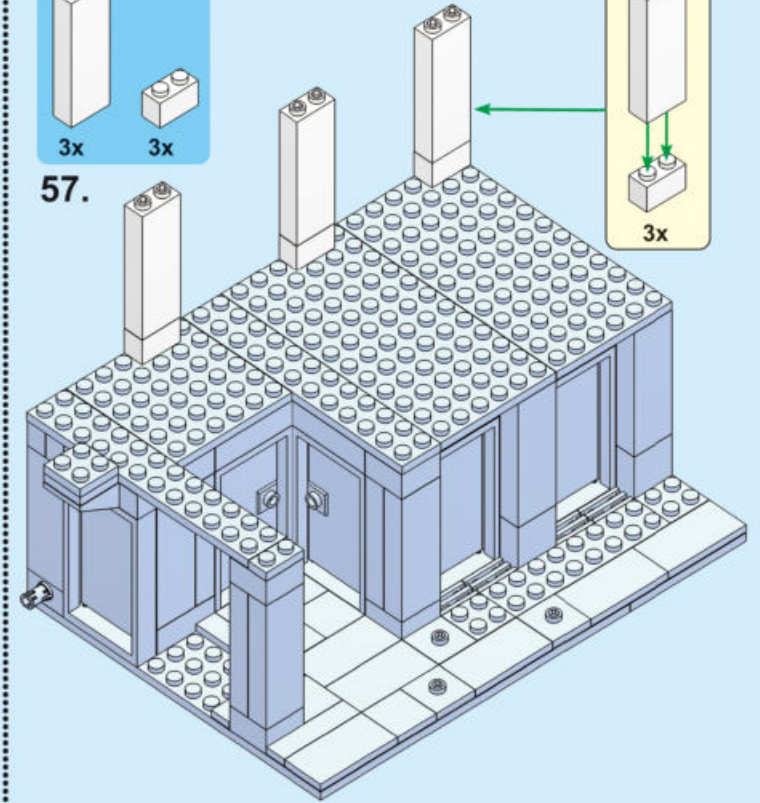
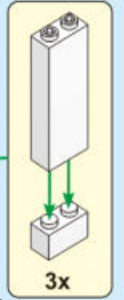

58.

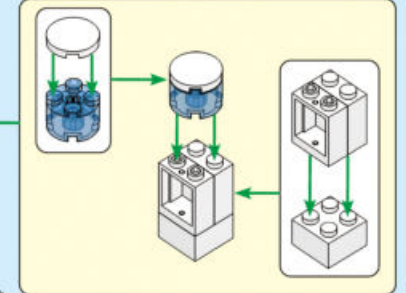
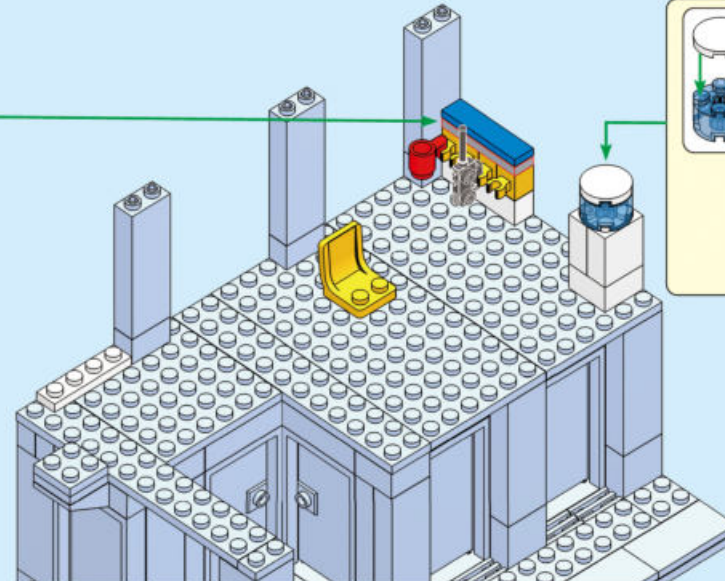
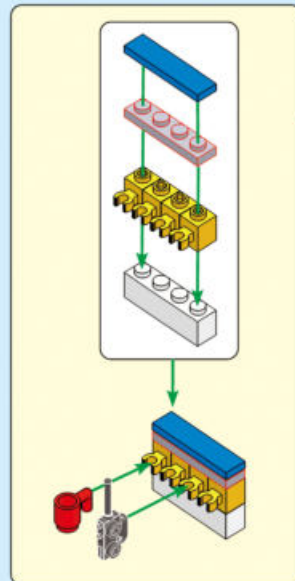



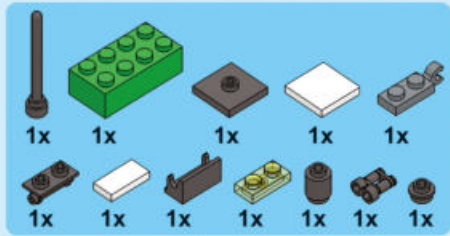

59.

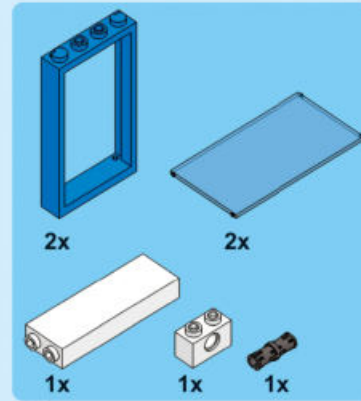
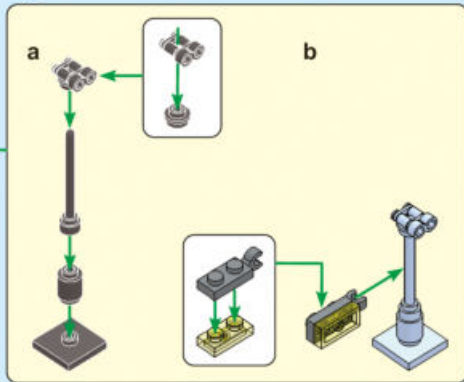
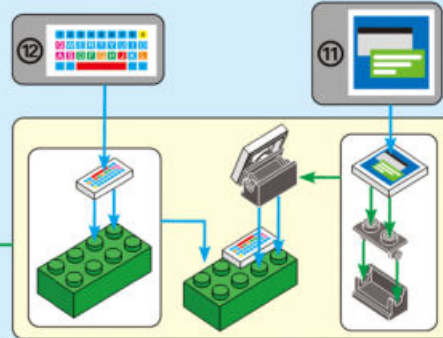

60.

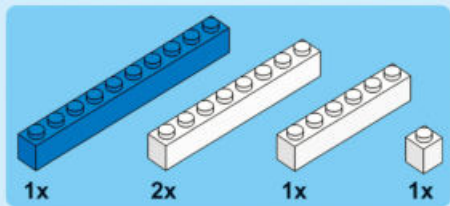
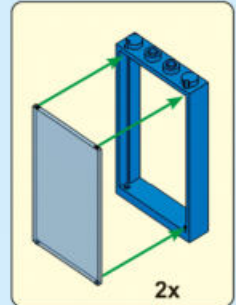
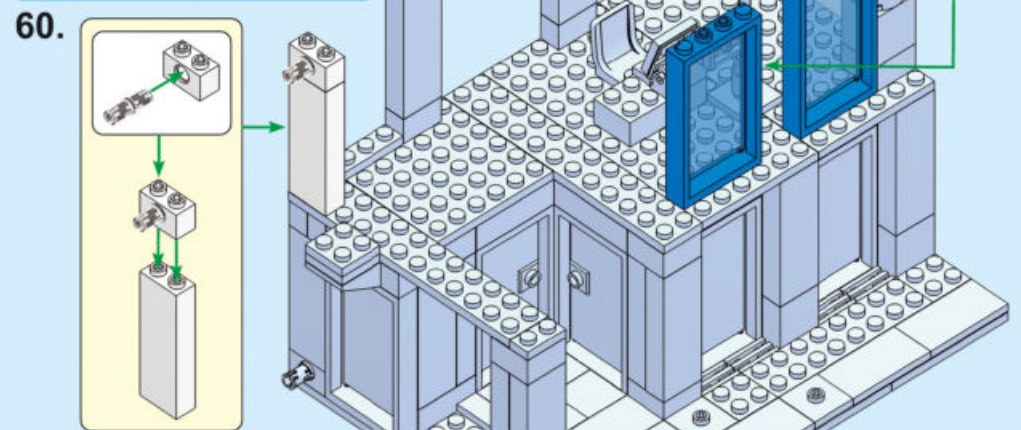

61.

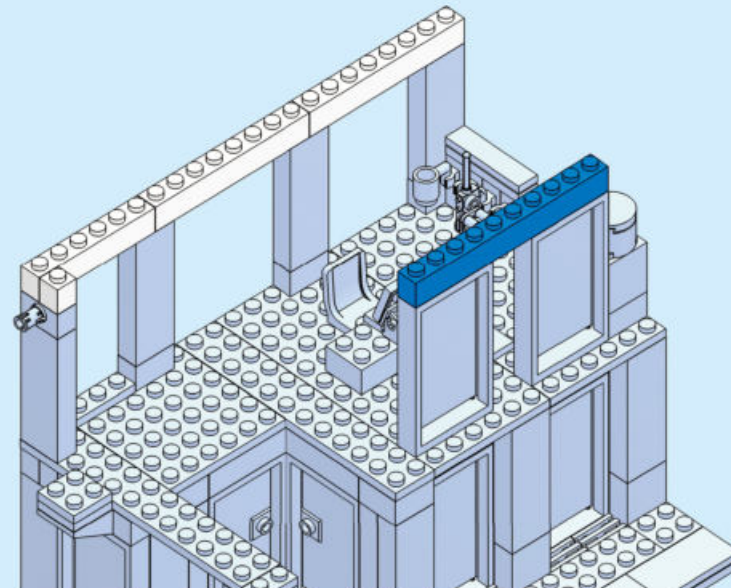

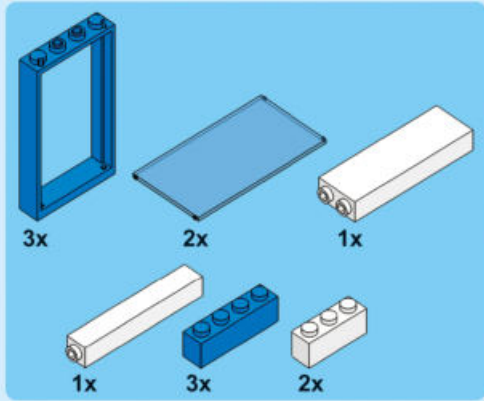

62.

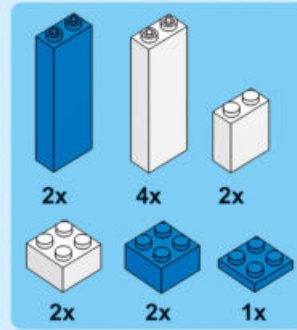
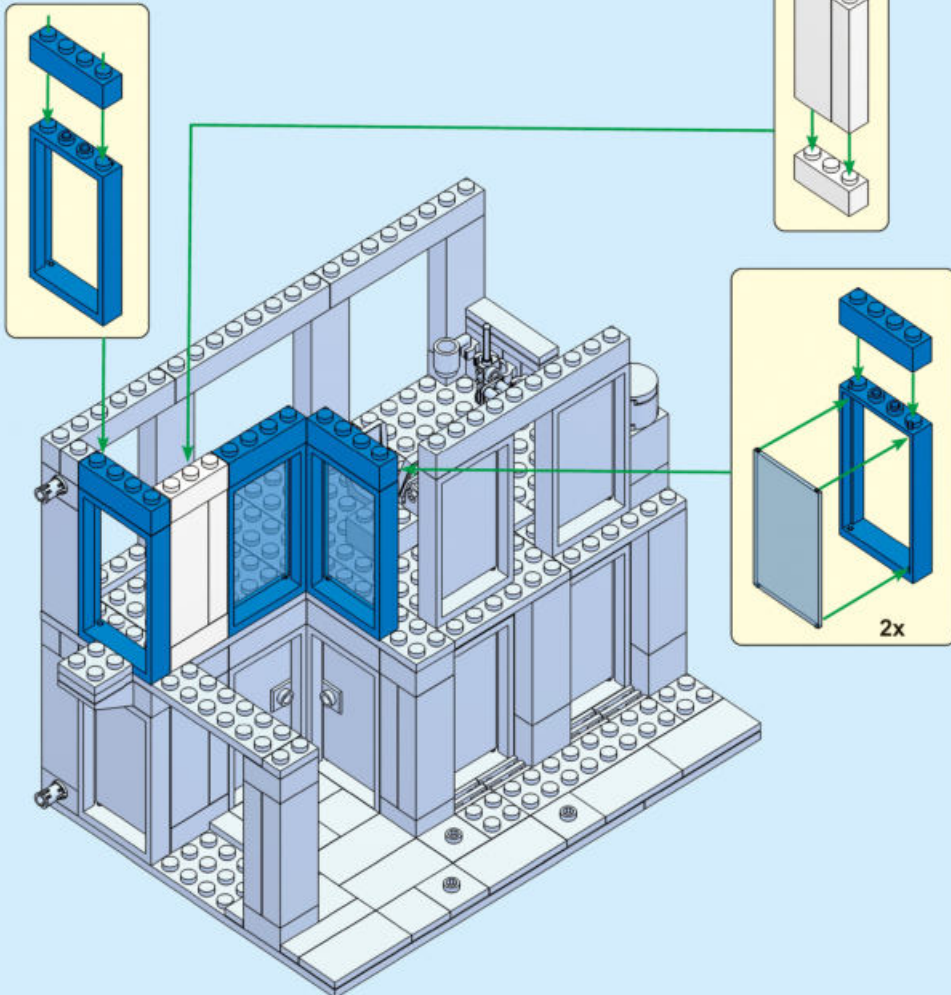

63.

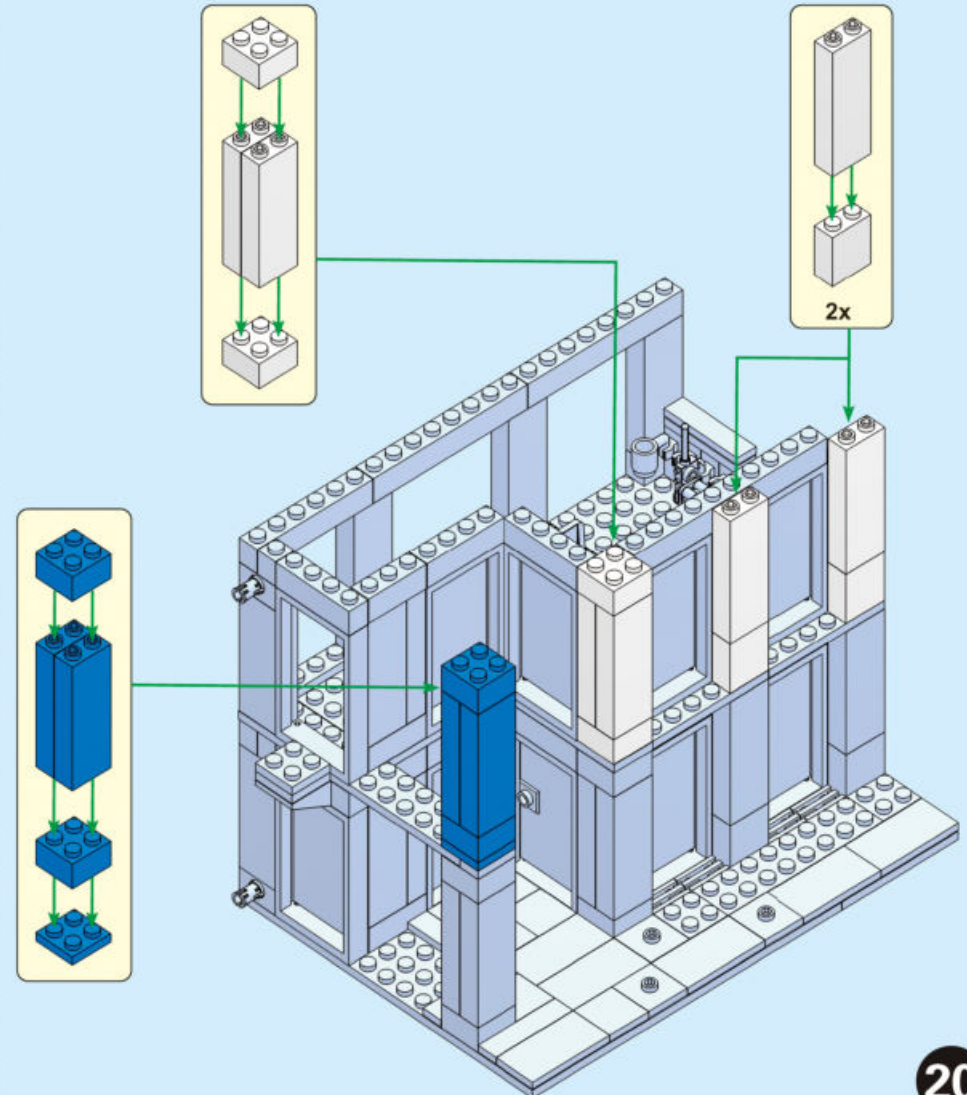



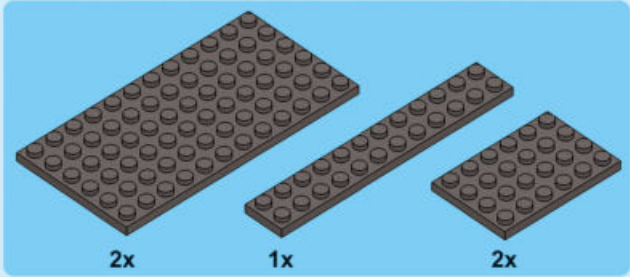

64.

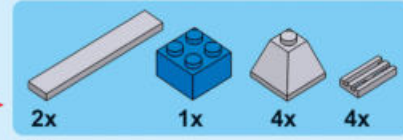
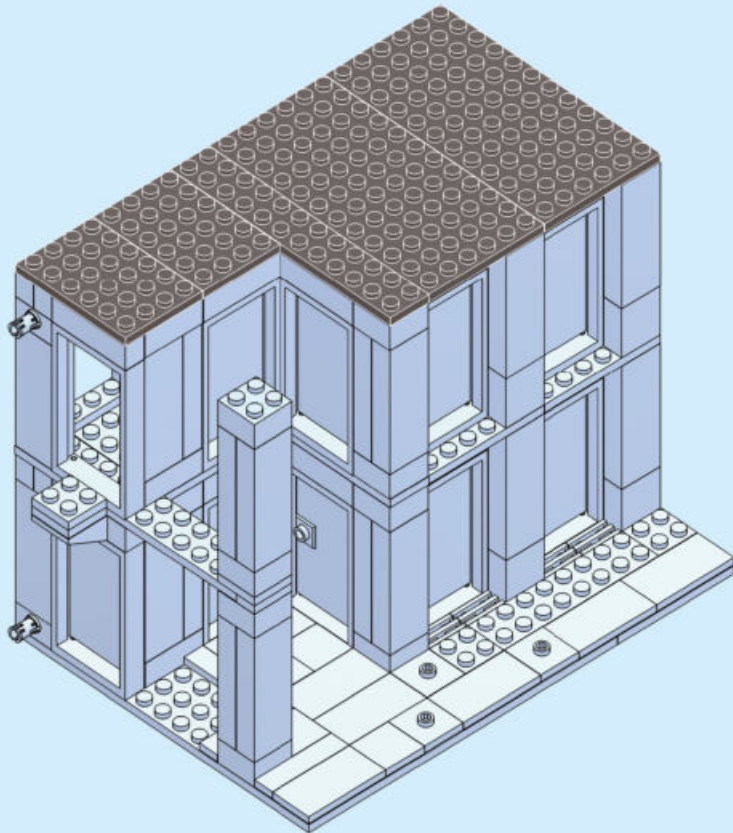

65.

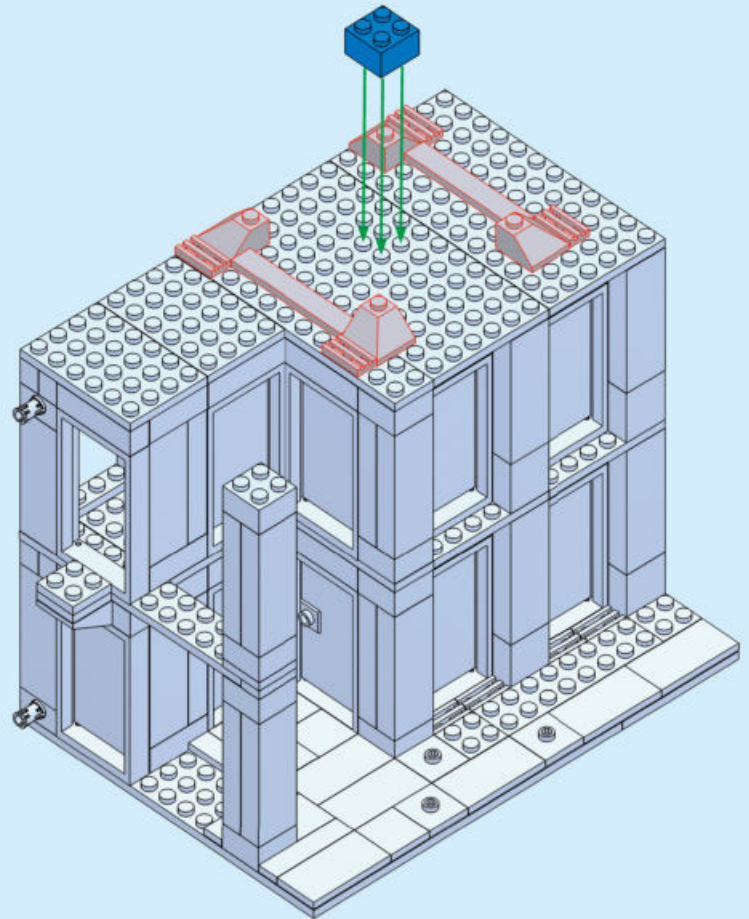

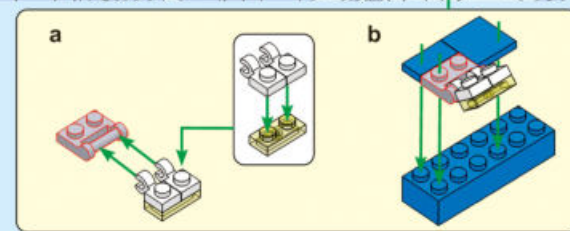
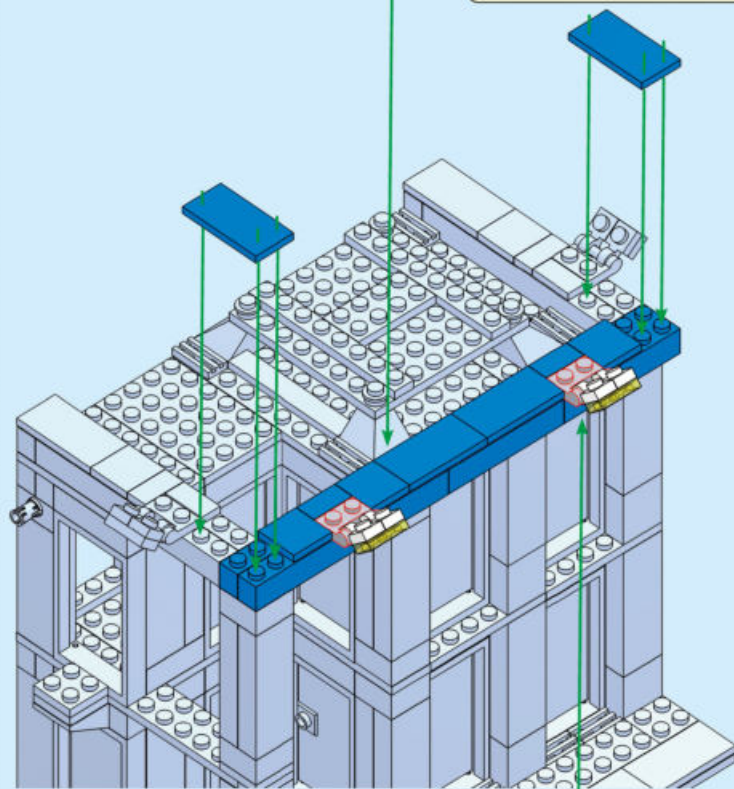
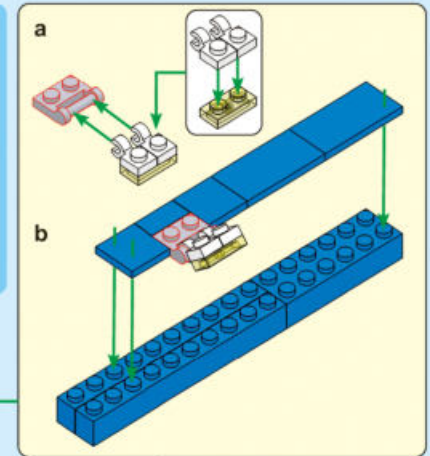
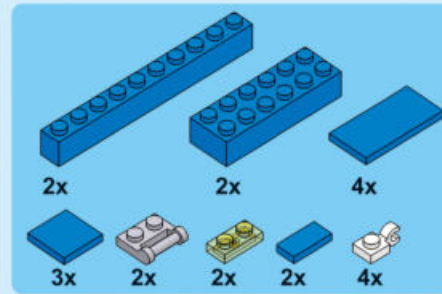
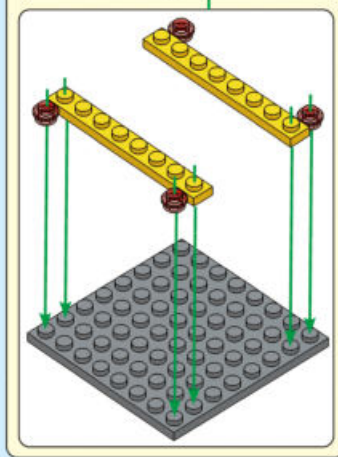
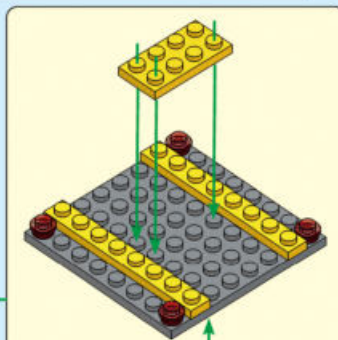
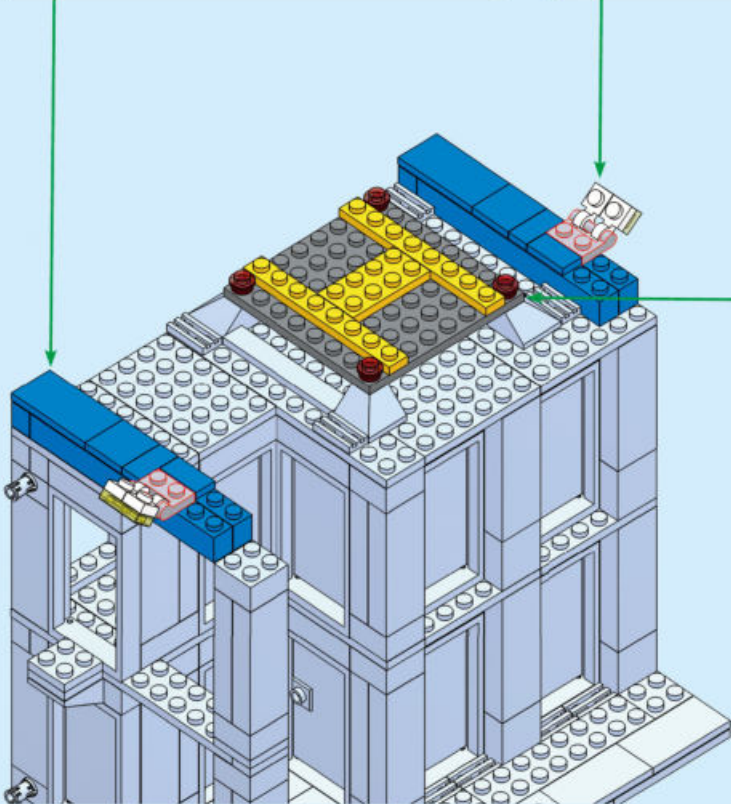
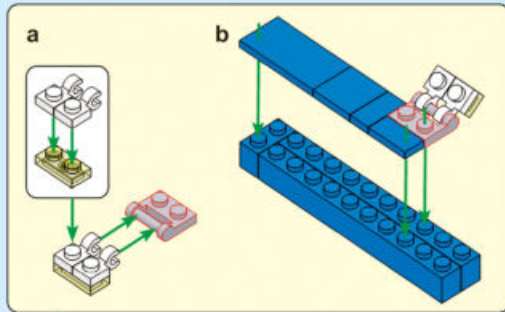
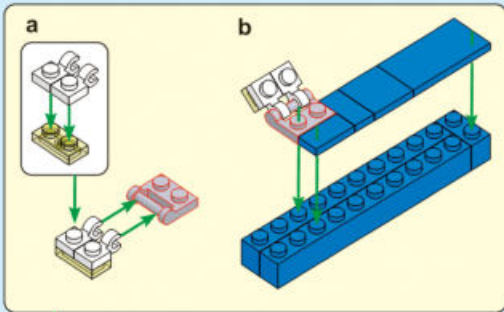
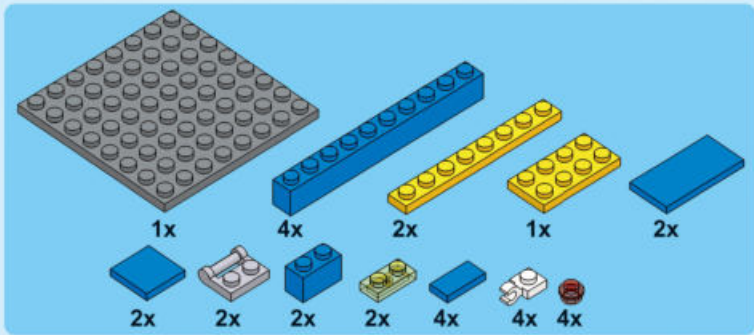



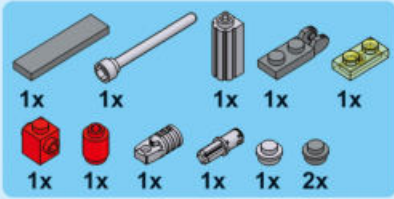

68.

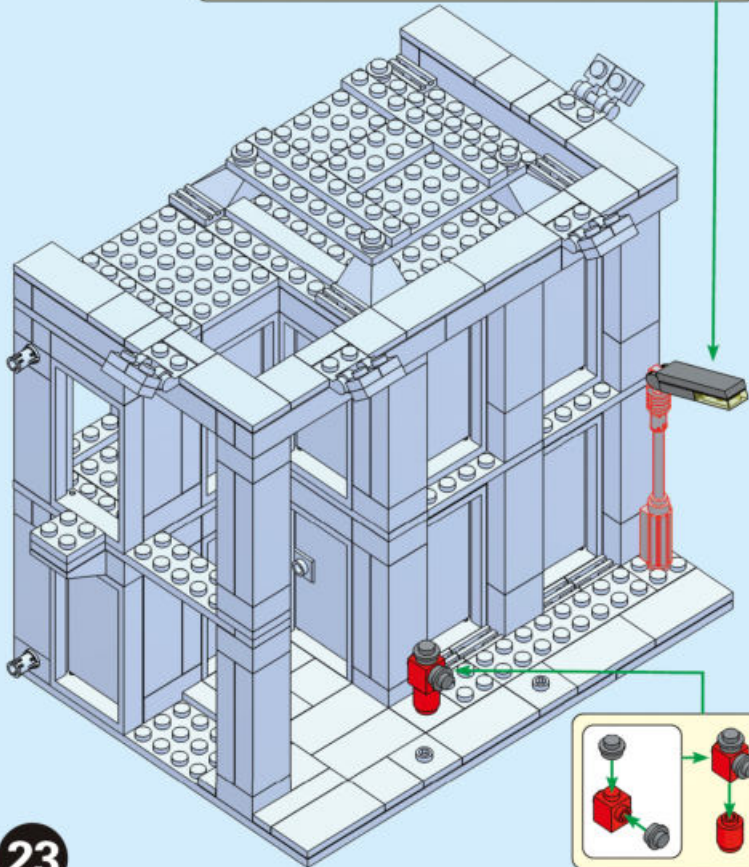
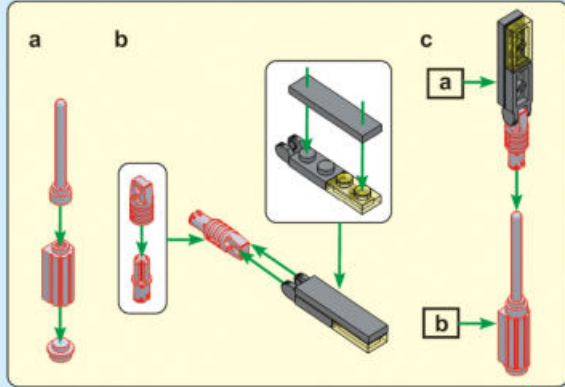

23

69.

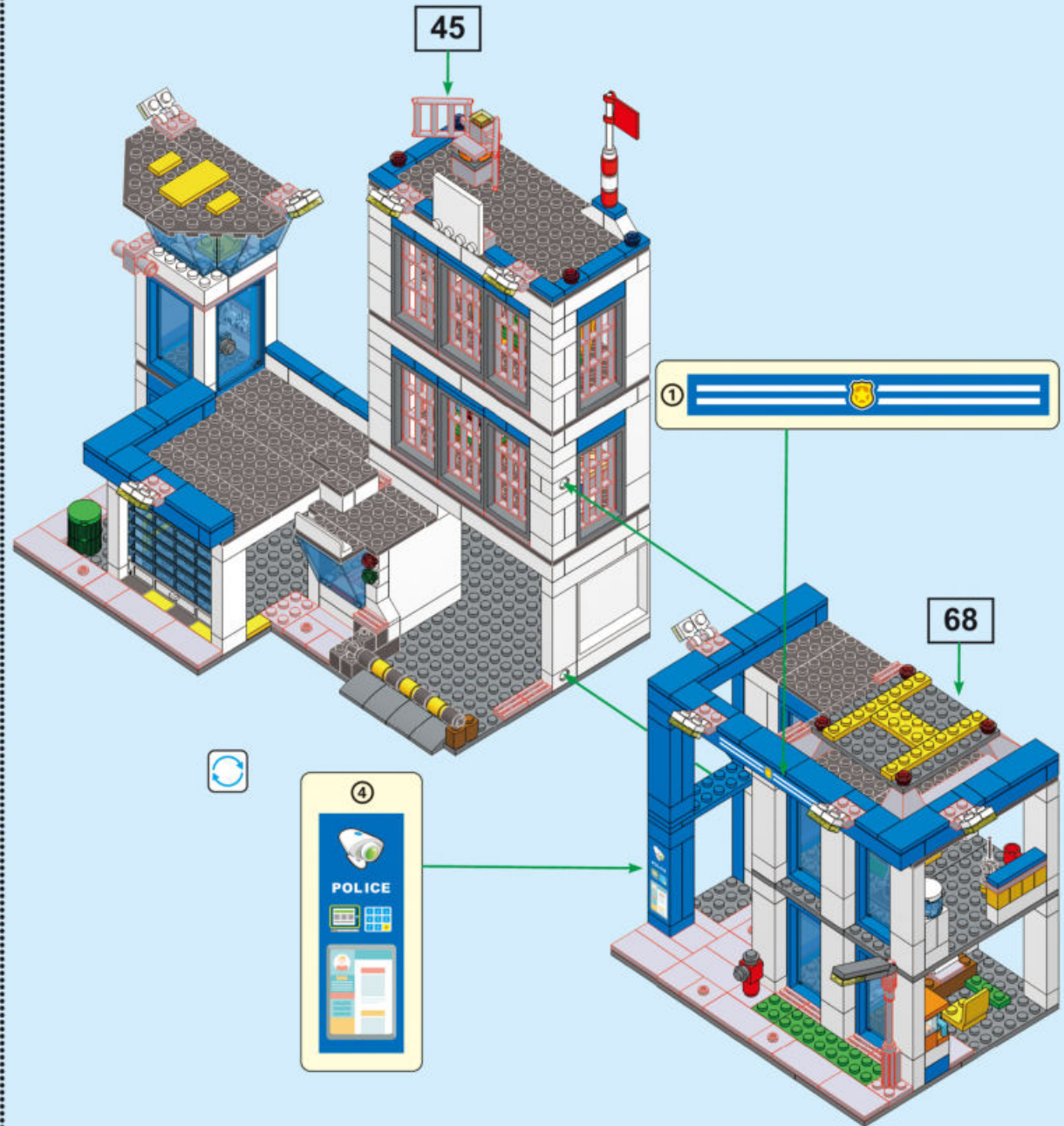



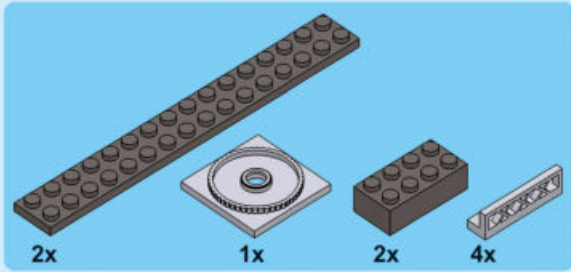

70.

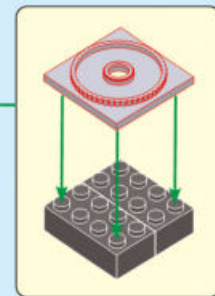
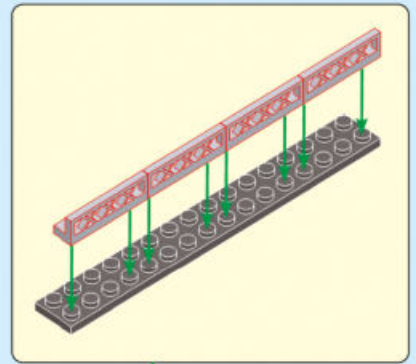
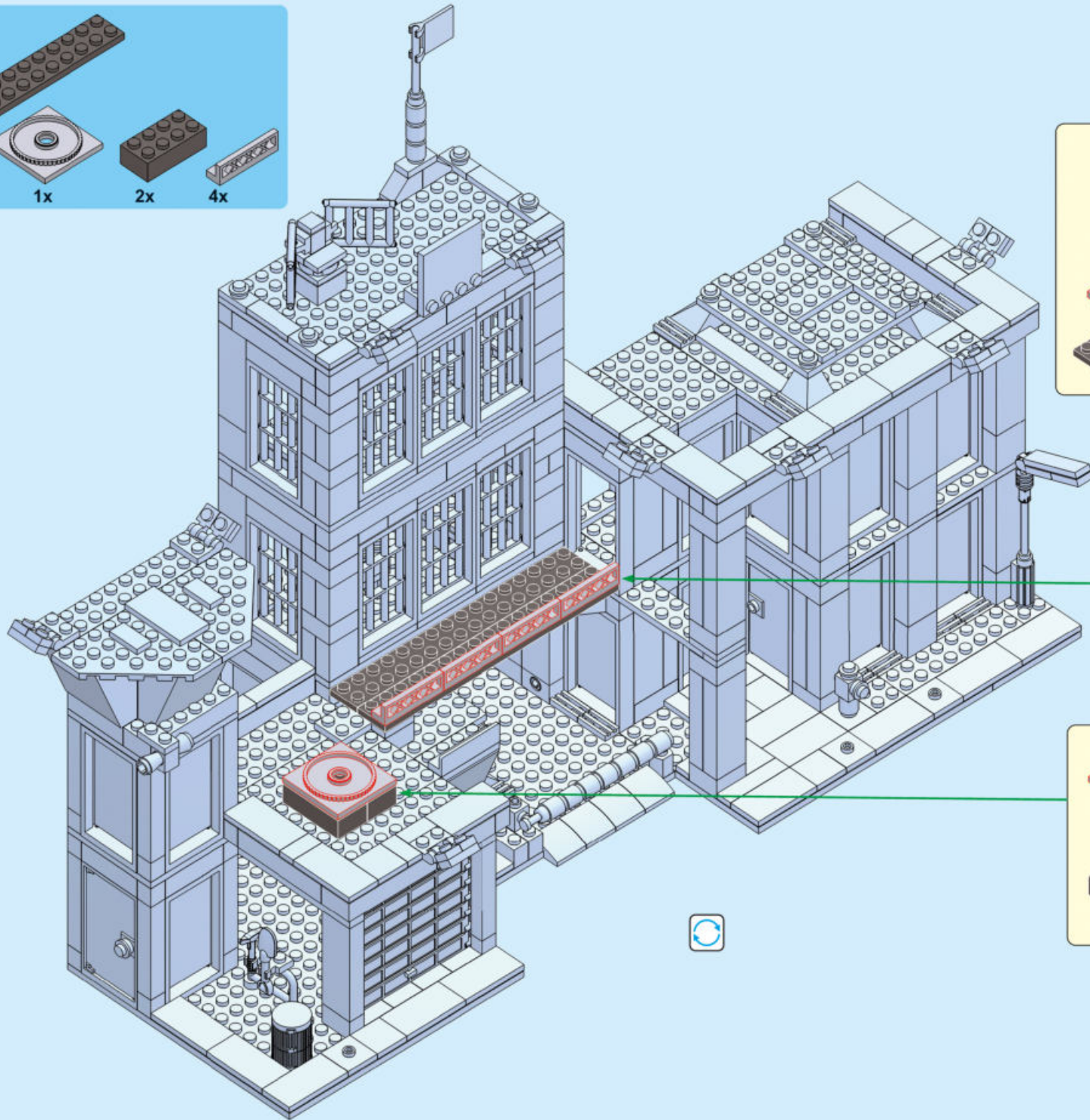





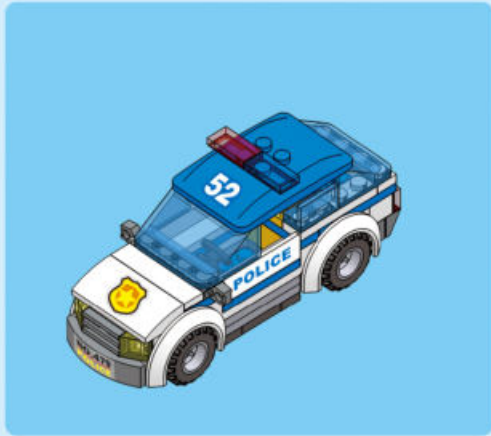

1.

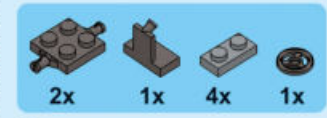
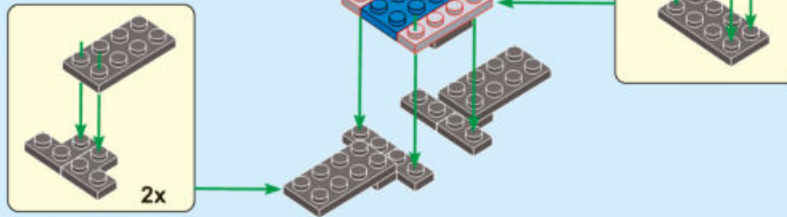

2.

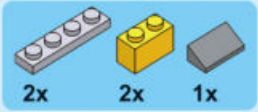
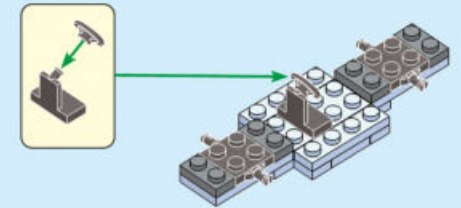

3.

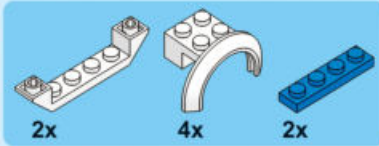
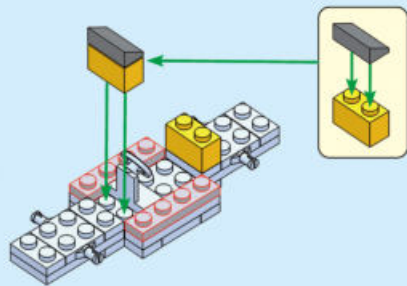

4.

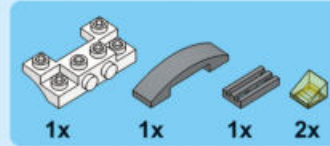
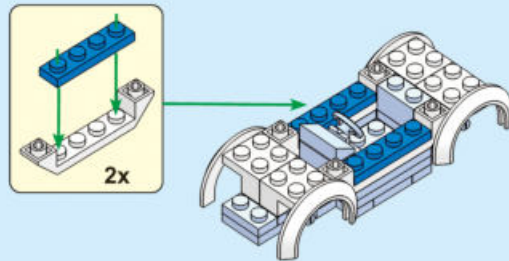

5.

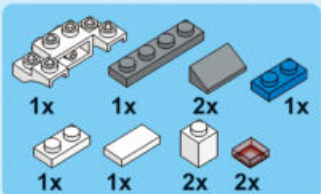
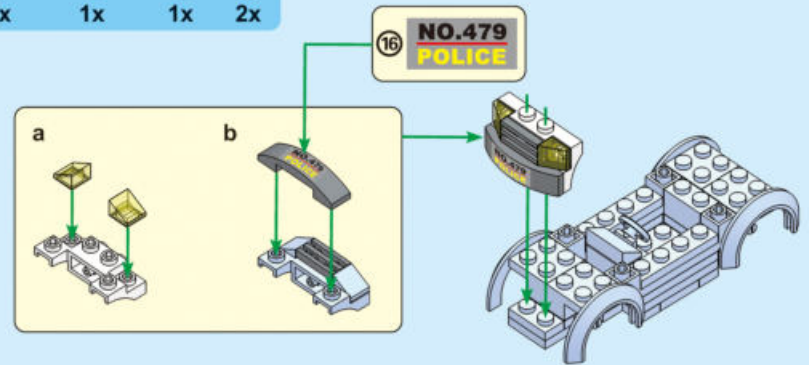

6.

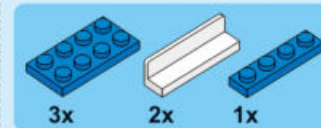
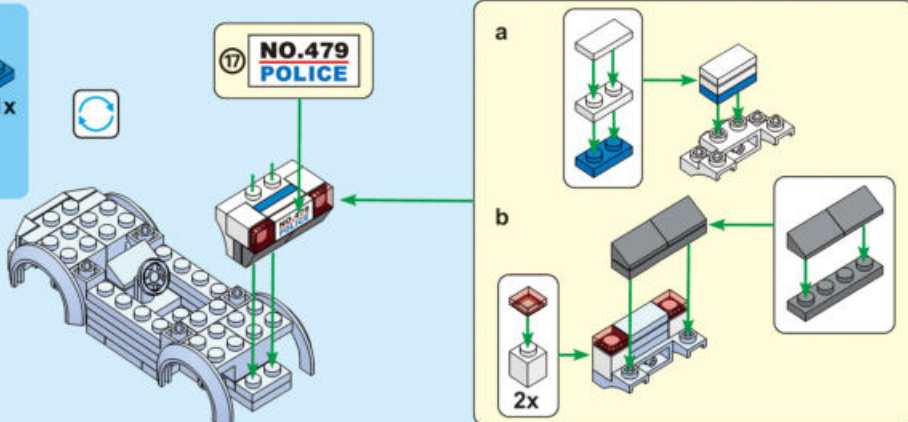

7.

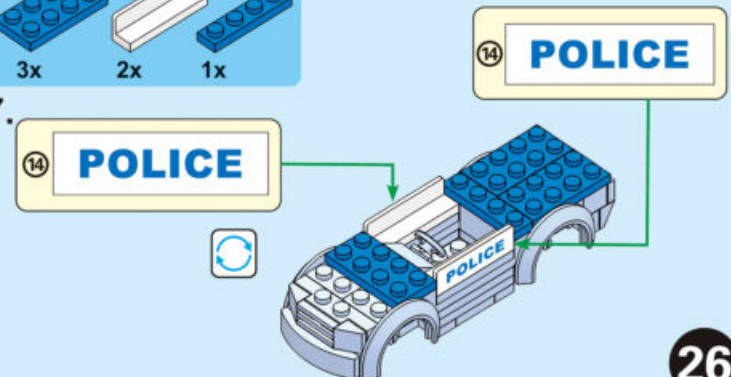



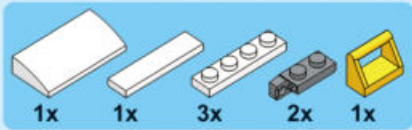

8.

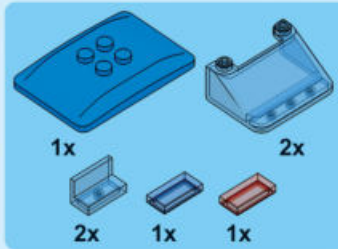
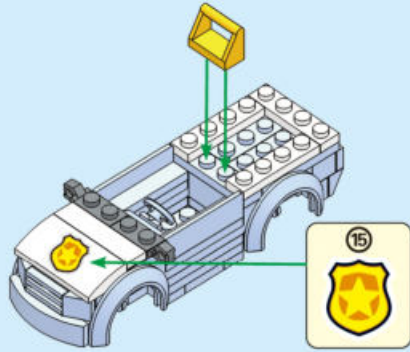

9.

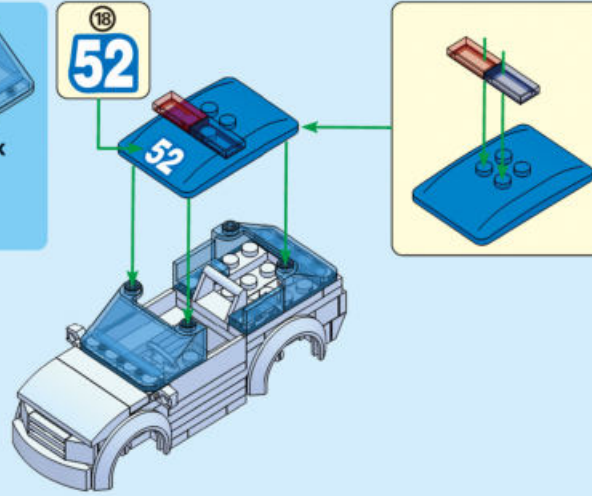

10.

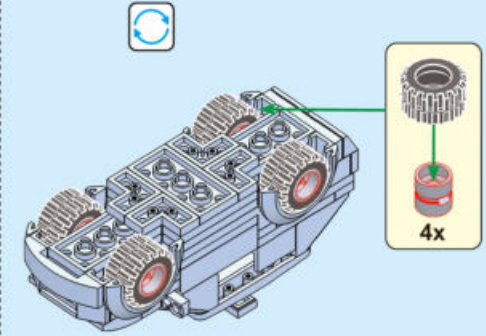

1.

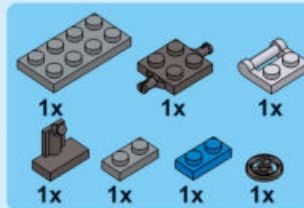
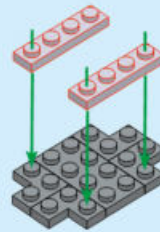

2.

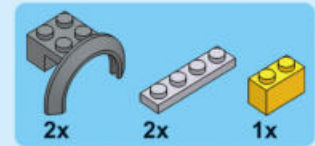
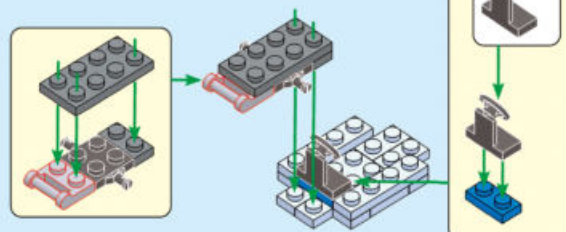

3.

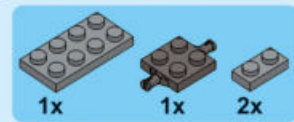
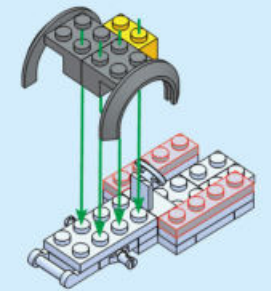

4.

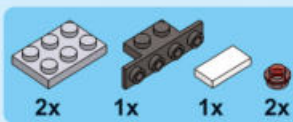
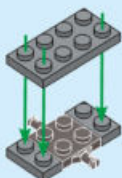

5.

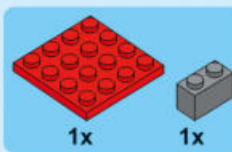
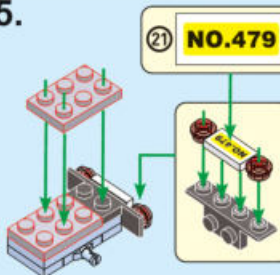

6.

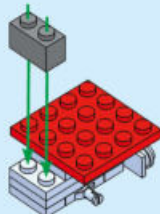

7.

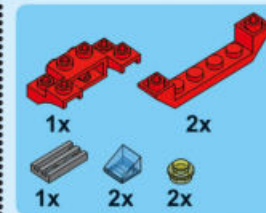
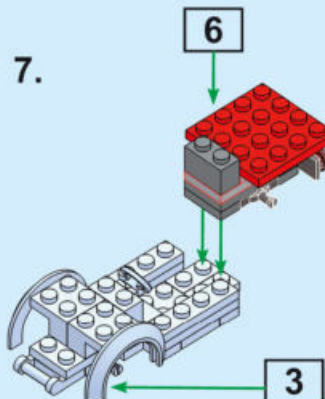

8.

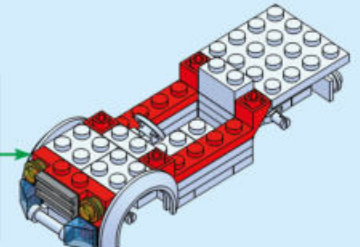
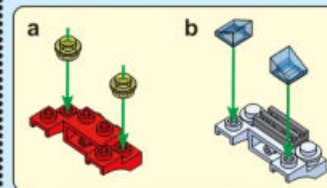

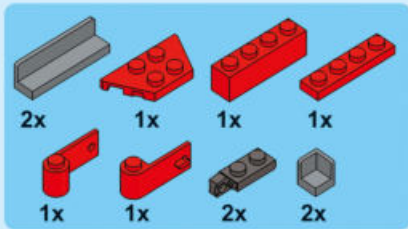

9.

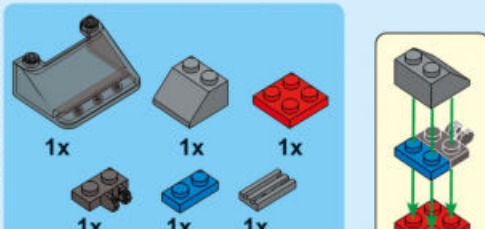
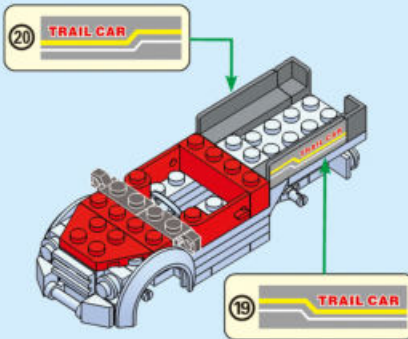

10.

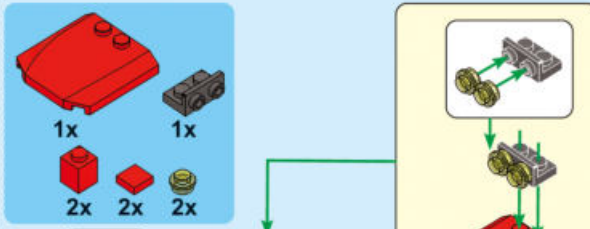
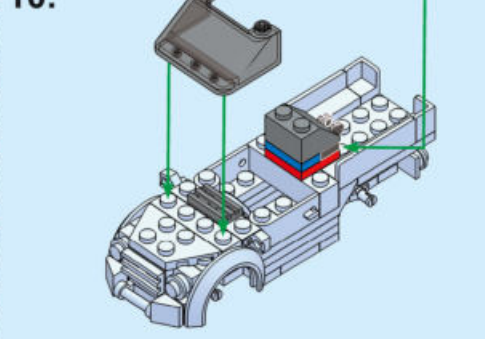

11.

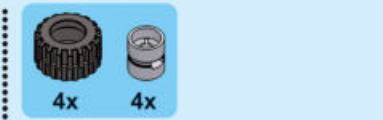
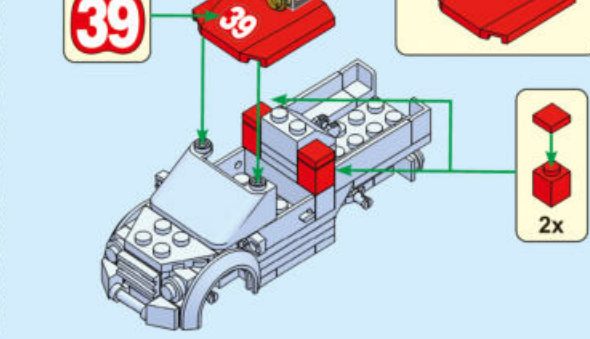

12.

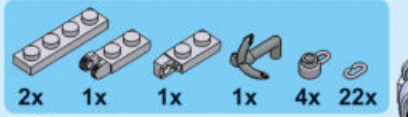
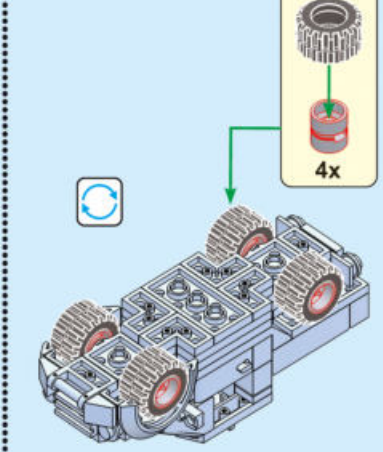

13.

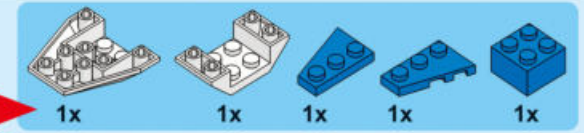
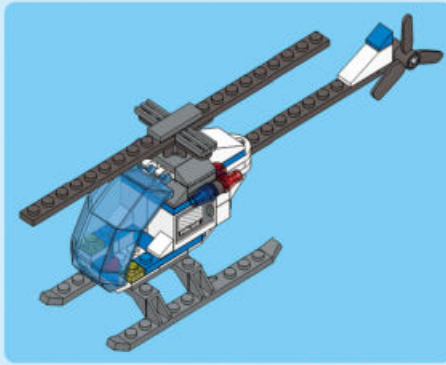
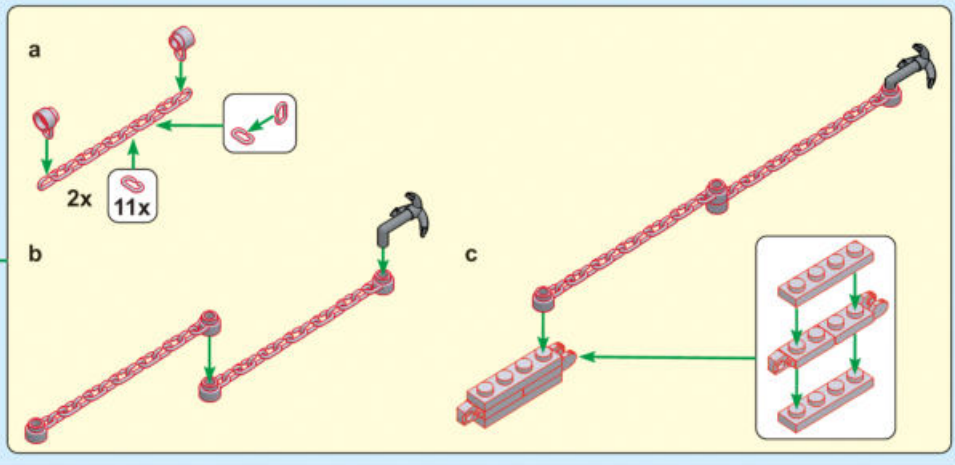
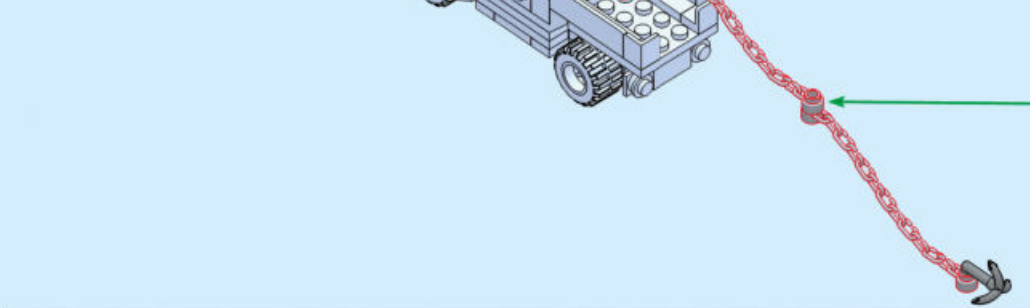

1.

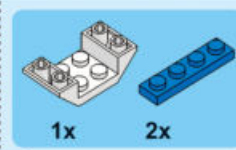
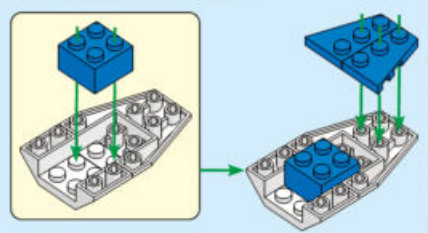

2.

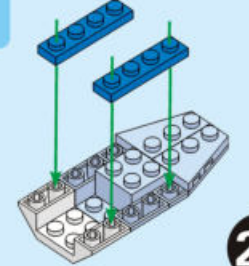





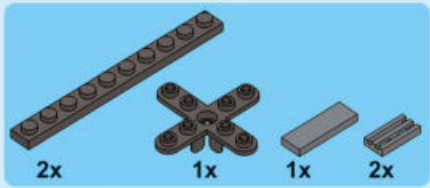

9.

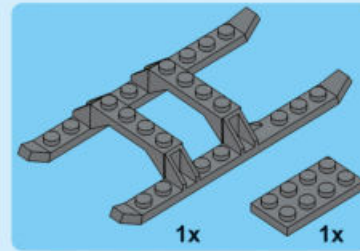
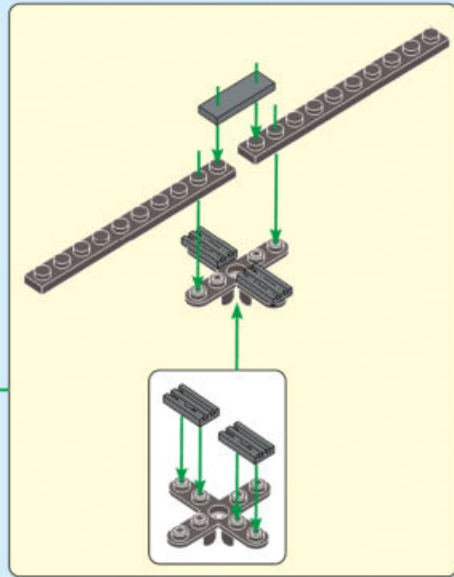
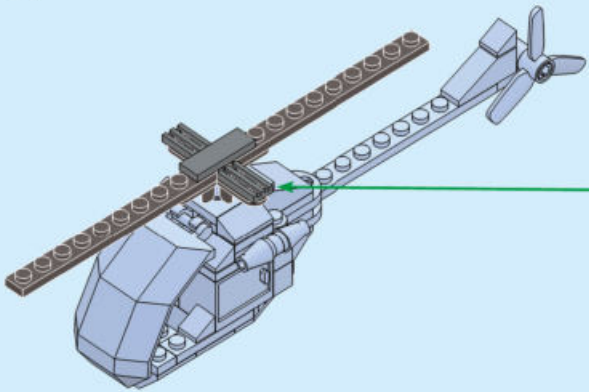

10.

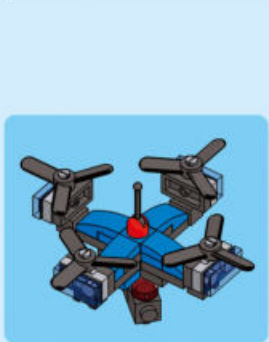
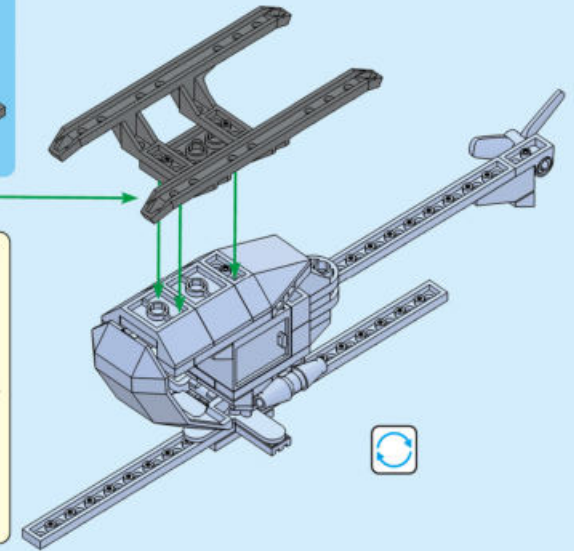
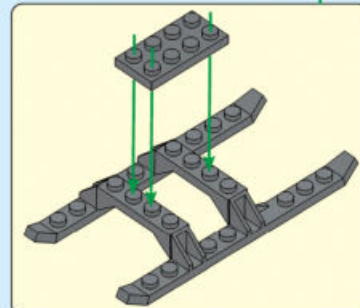

11

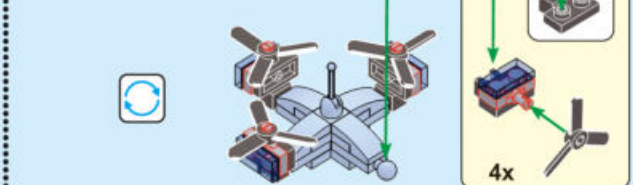
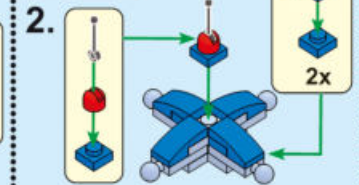
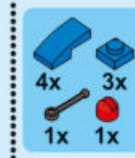
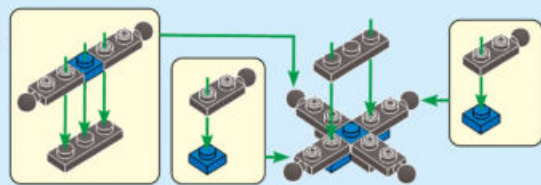
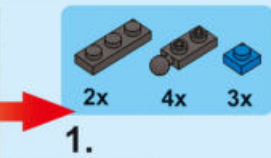

4.

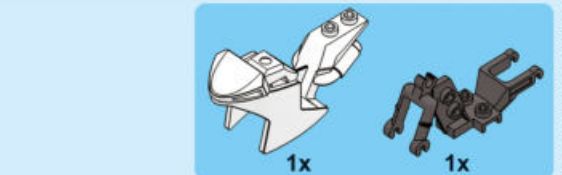
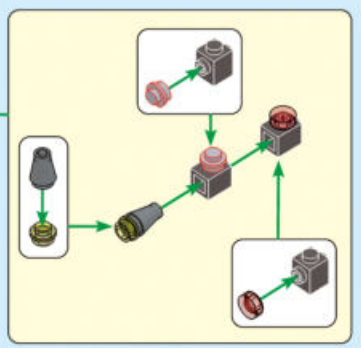
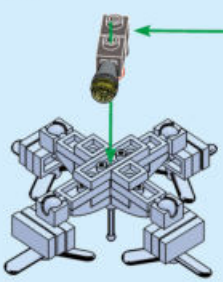

1.

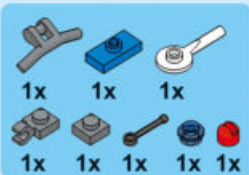
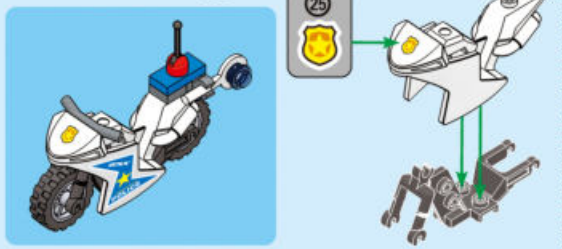

2.

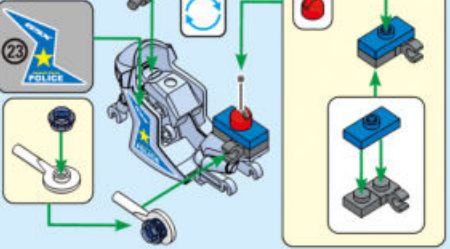

3.

