

4.

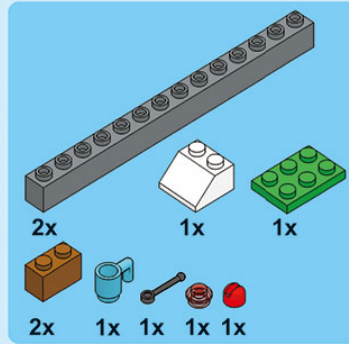

5.

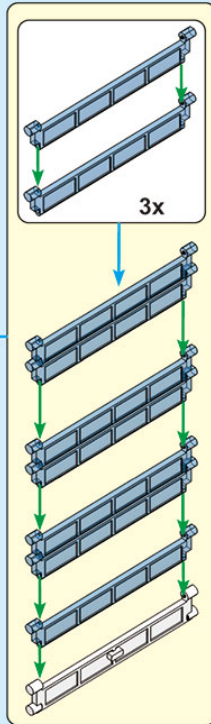
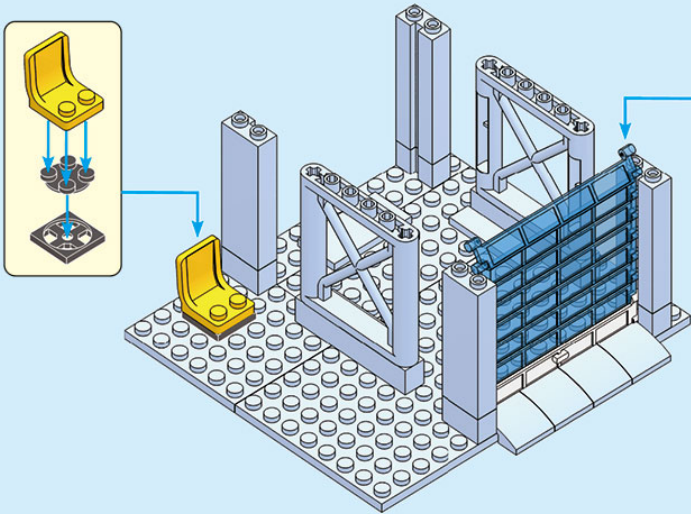
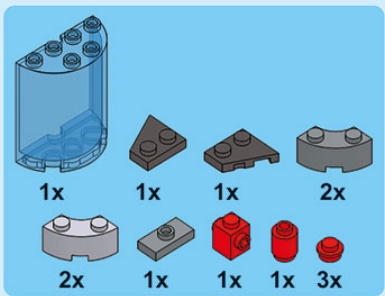
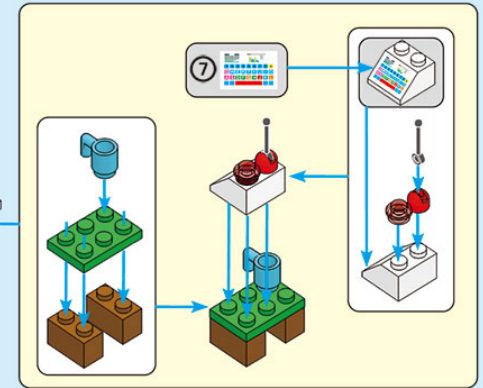
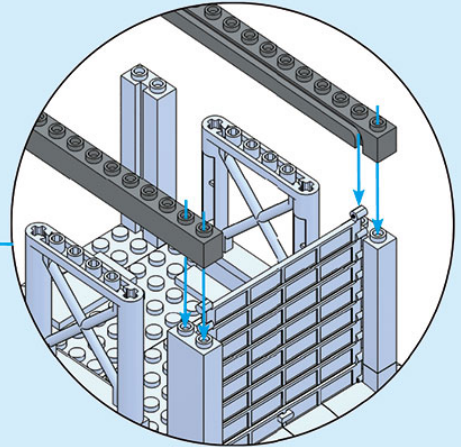
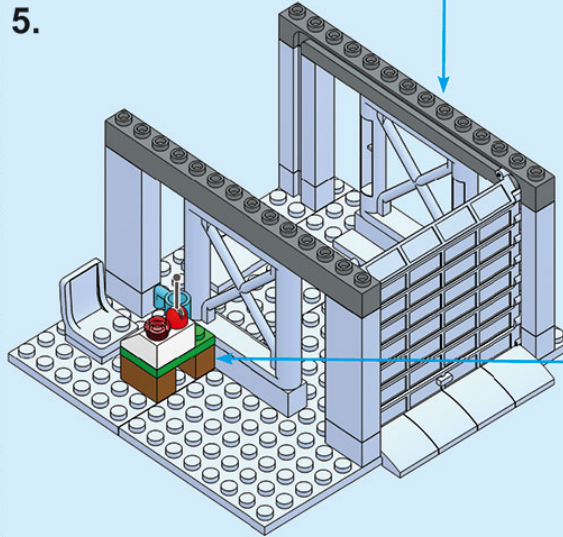

6.

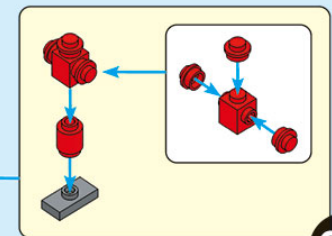
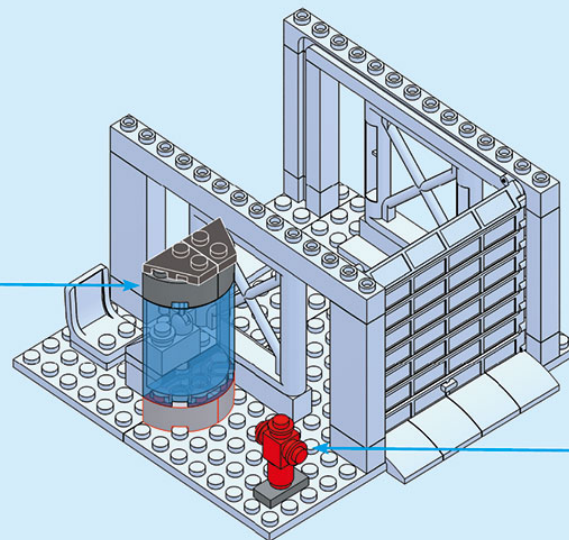
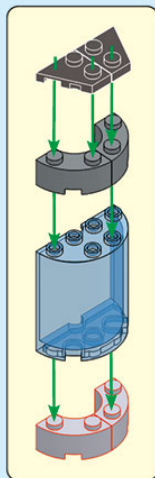

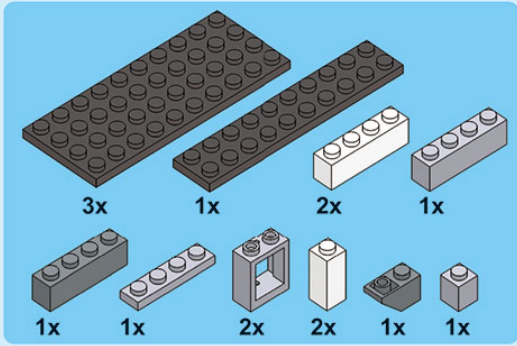

7.

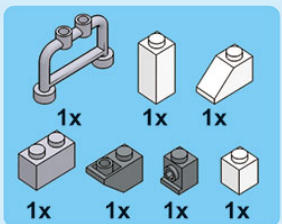
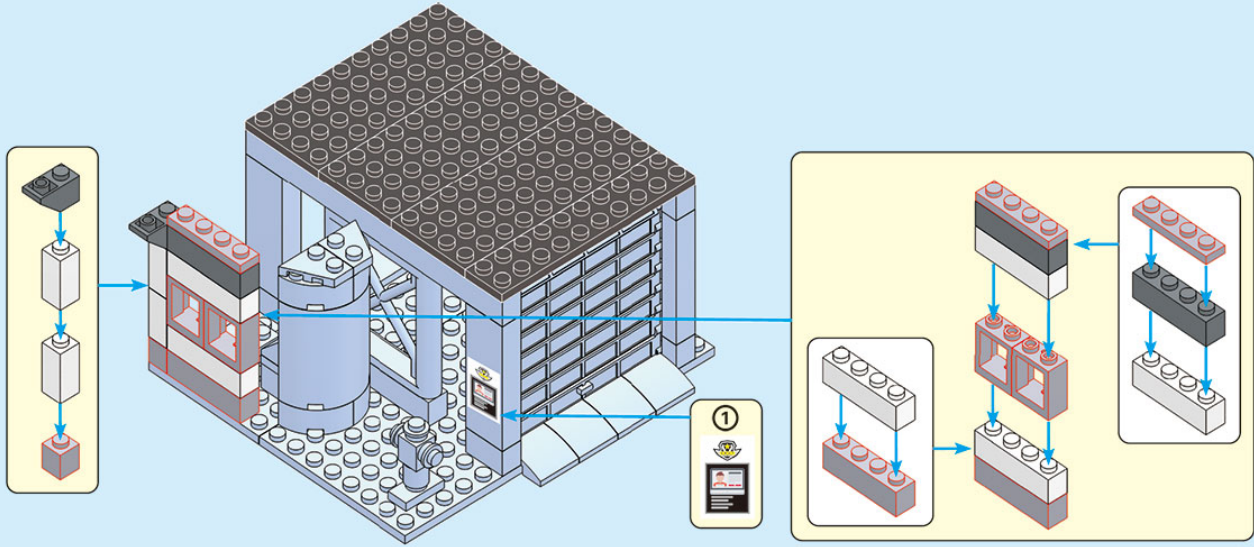

8.

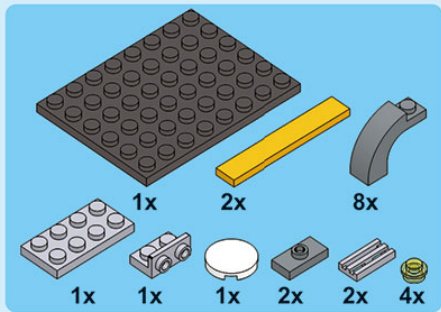
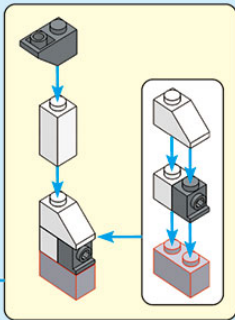

9.

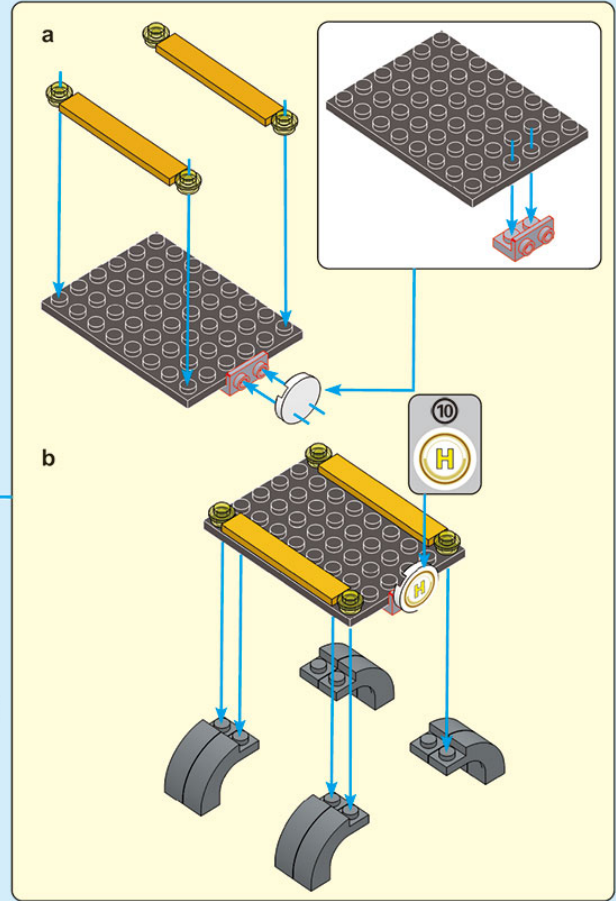
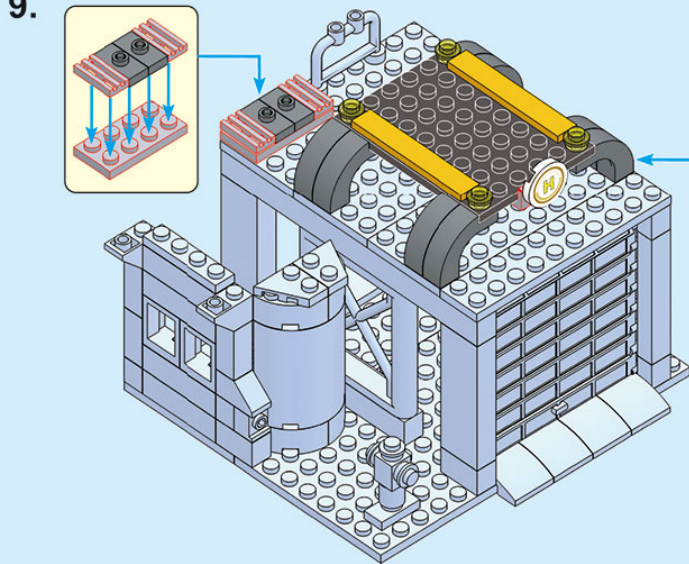
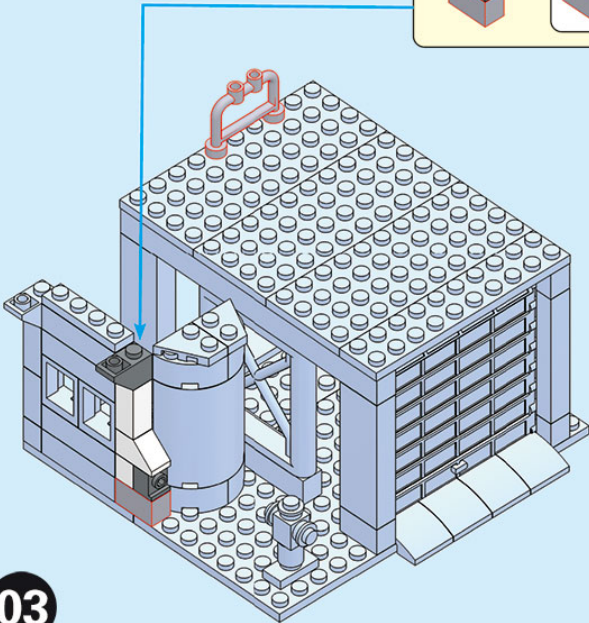
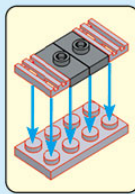

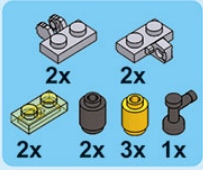

10.

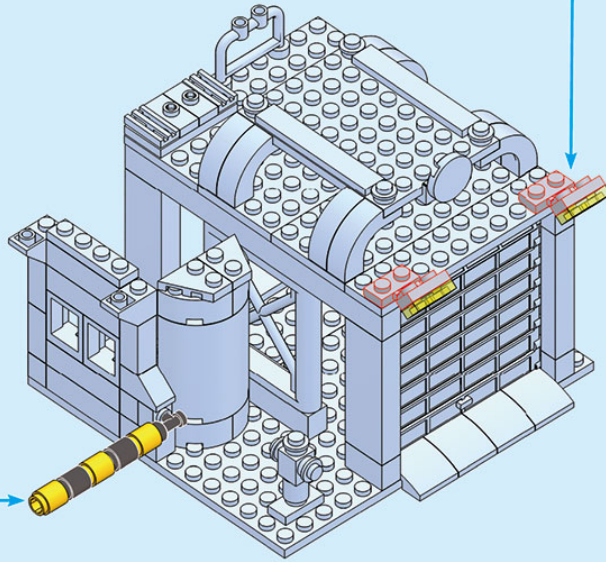
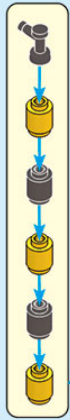
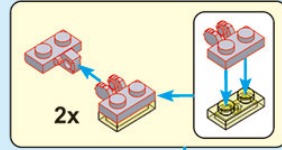

2

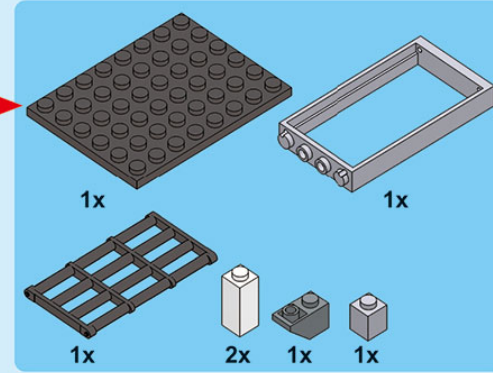

11.

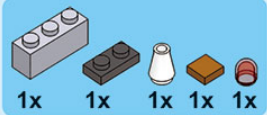
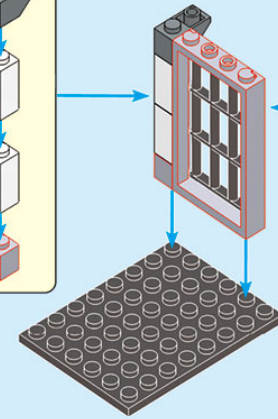
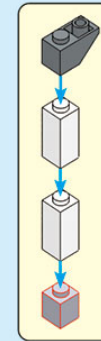
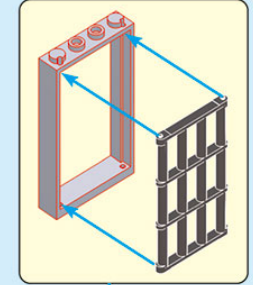

12.

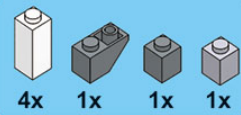
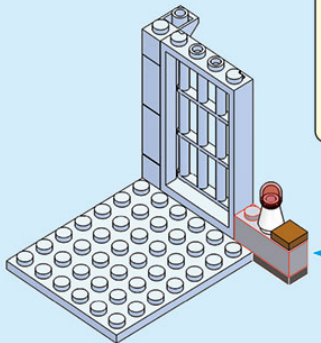
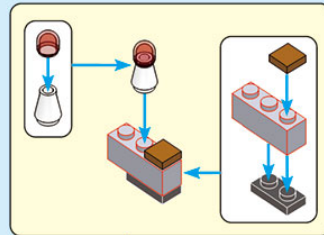

13.

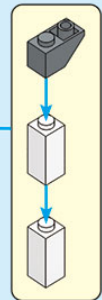
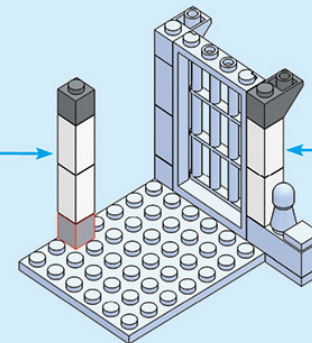
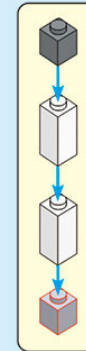

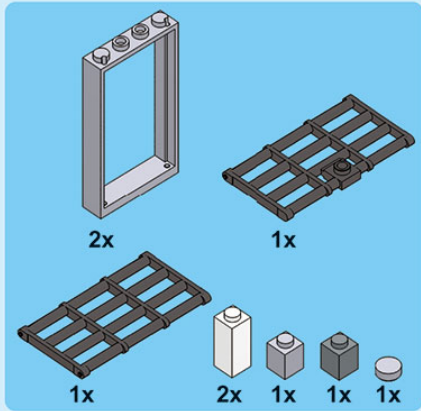

14.

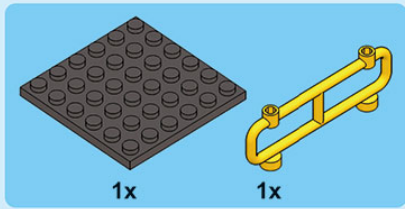
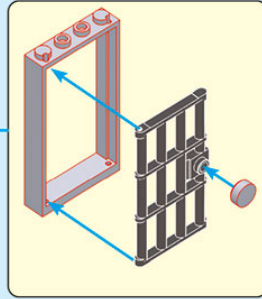
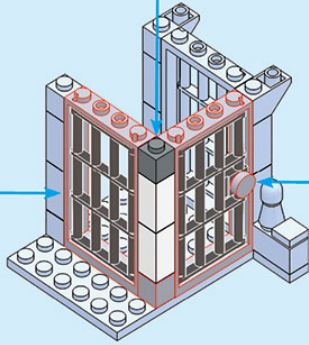
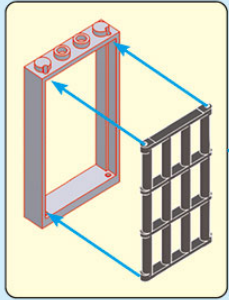
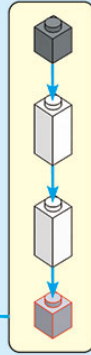

15.

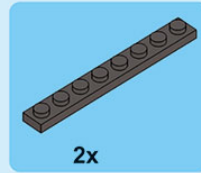
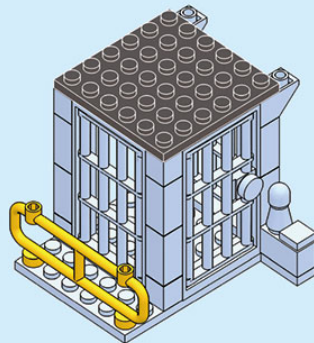

16.

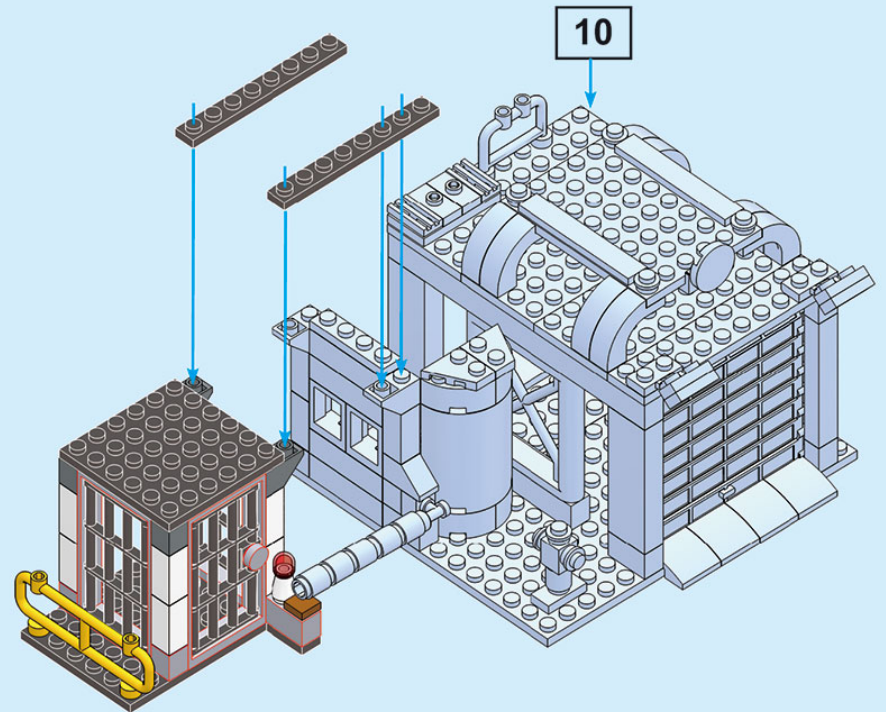

15



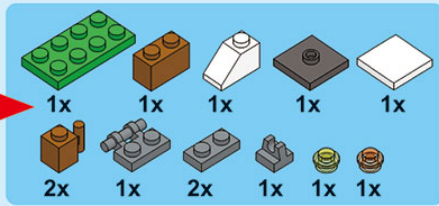

19.

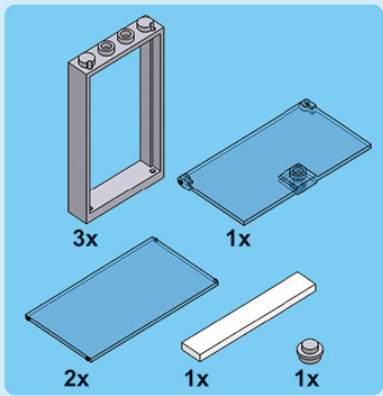
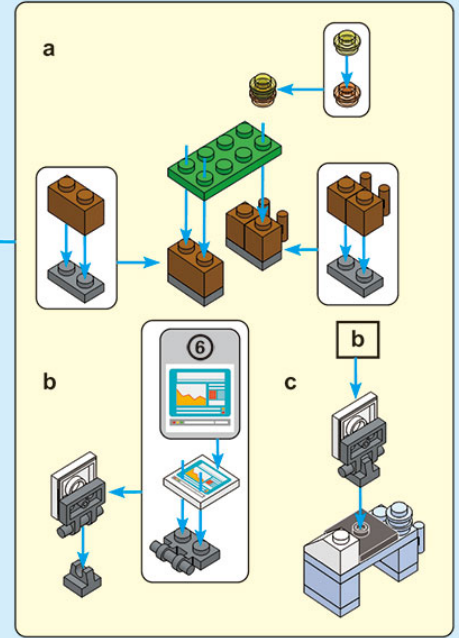
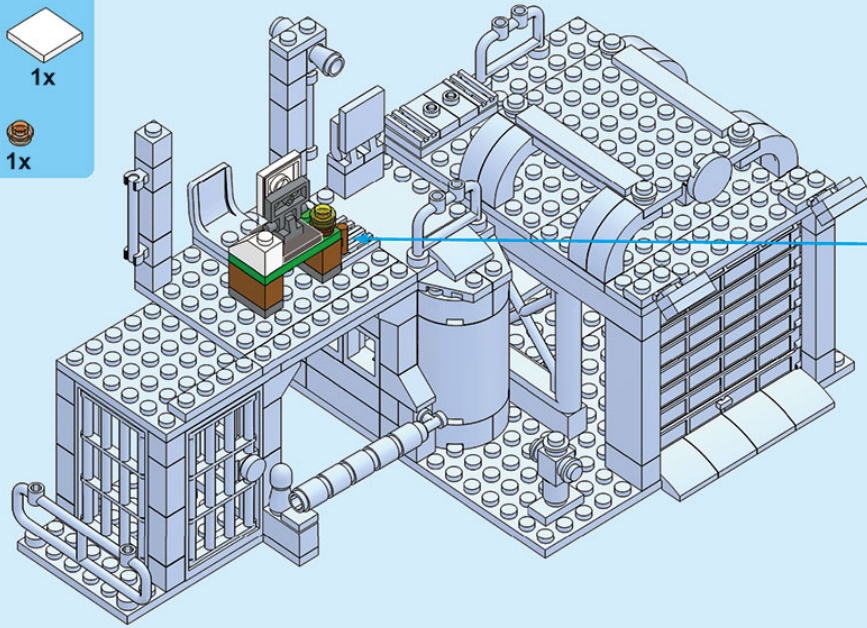

20.

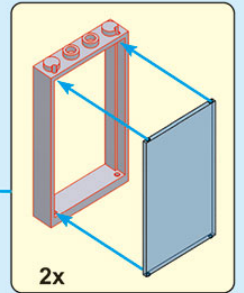
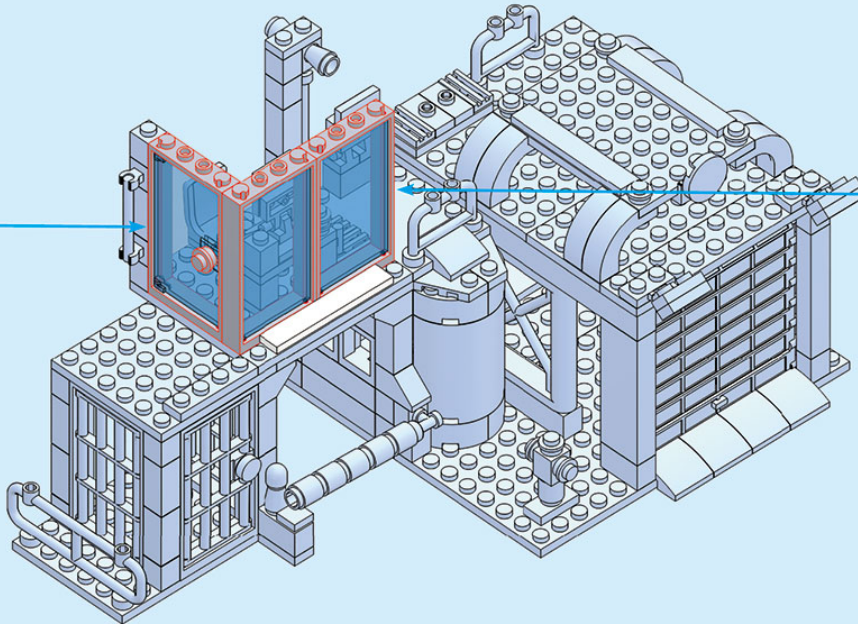
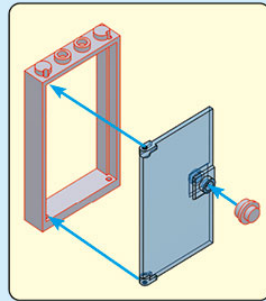

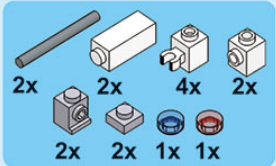

21.

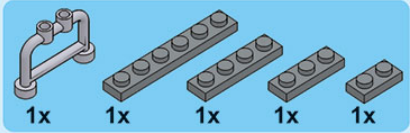
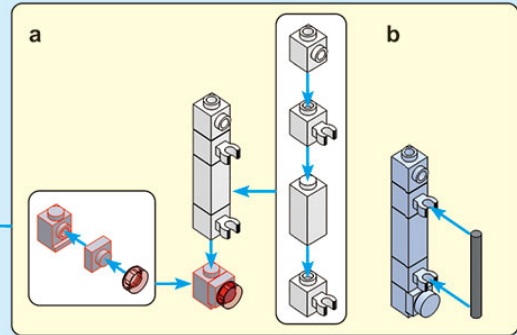
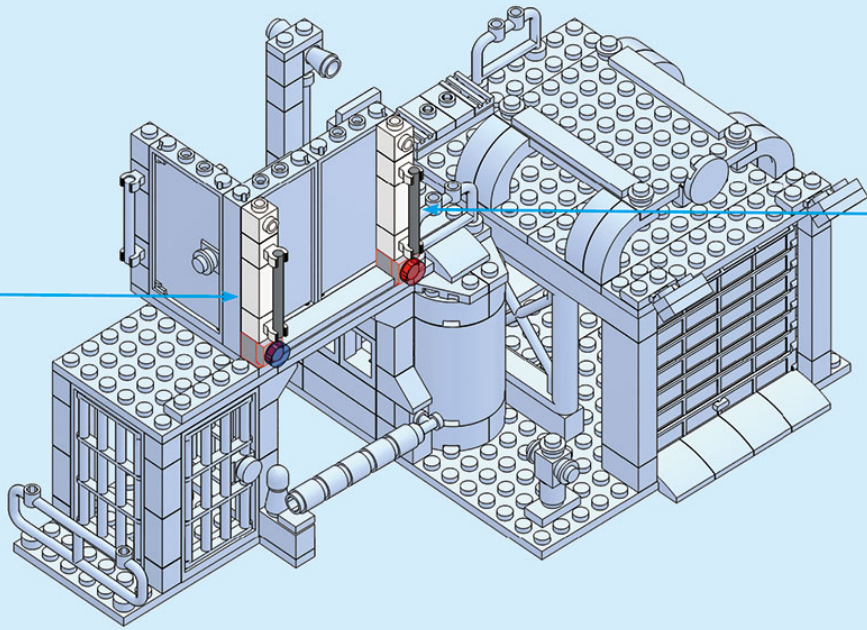
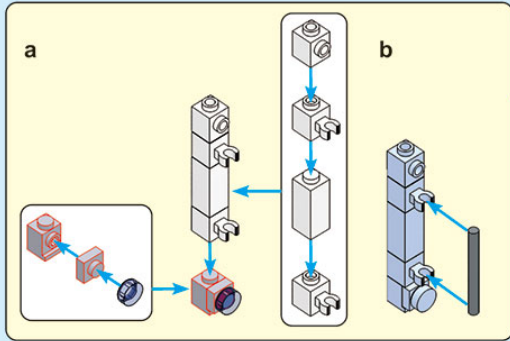

22.

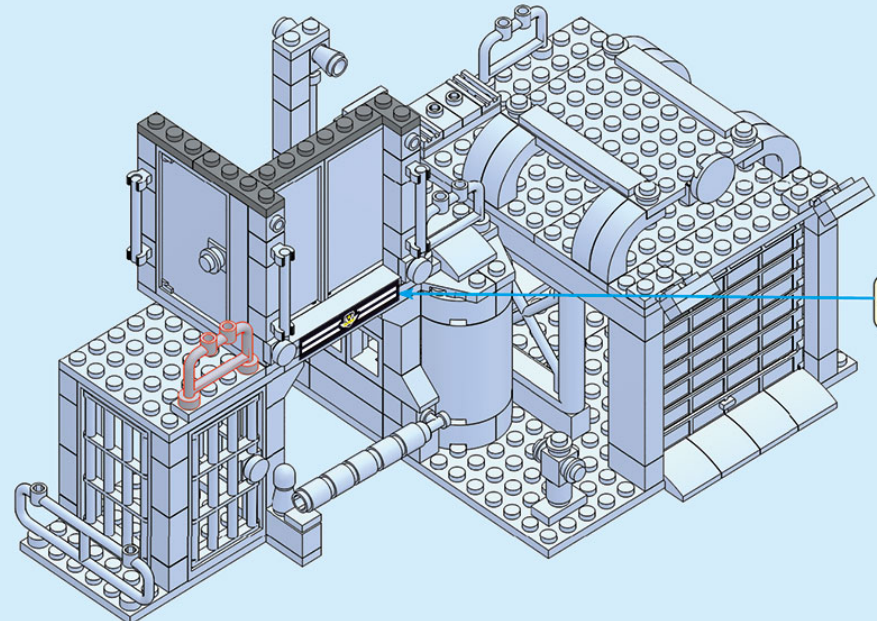



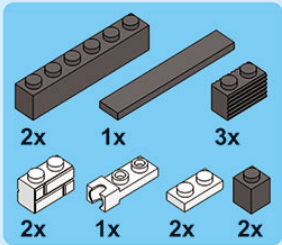

23.

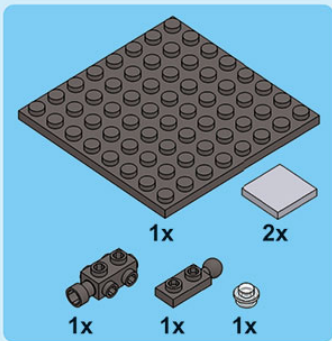
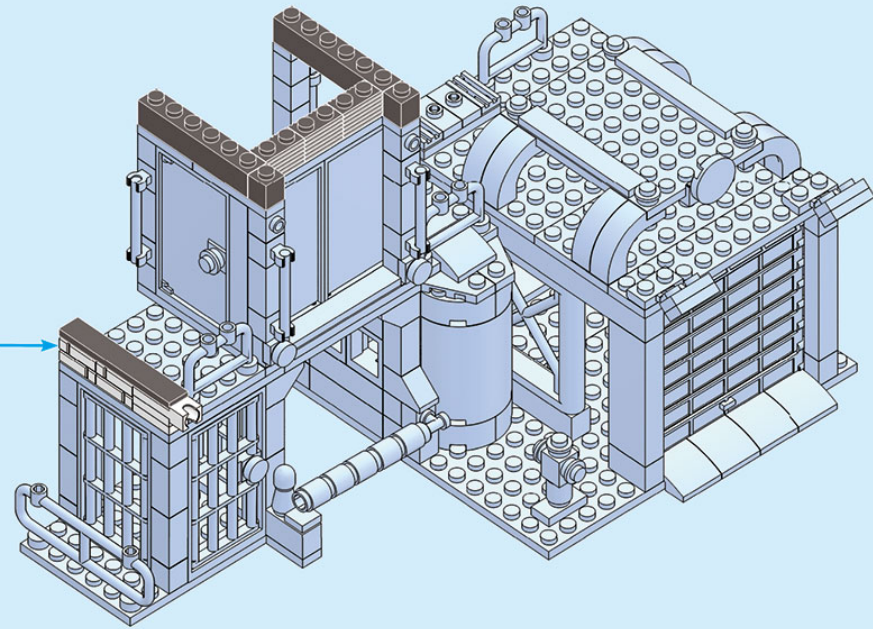
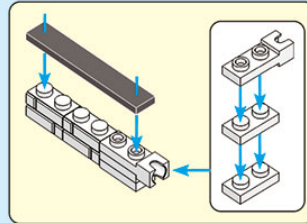

24.

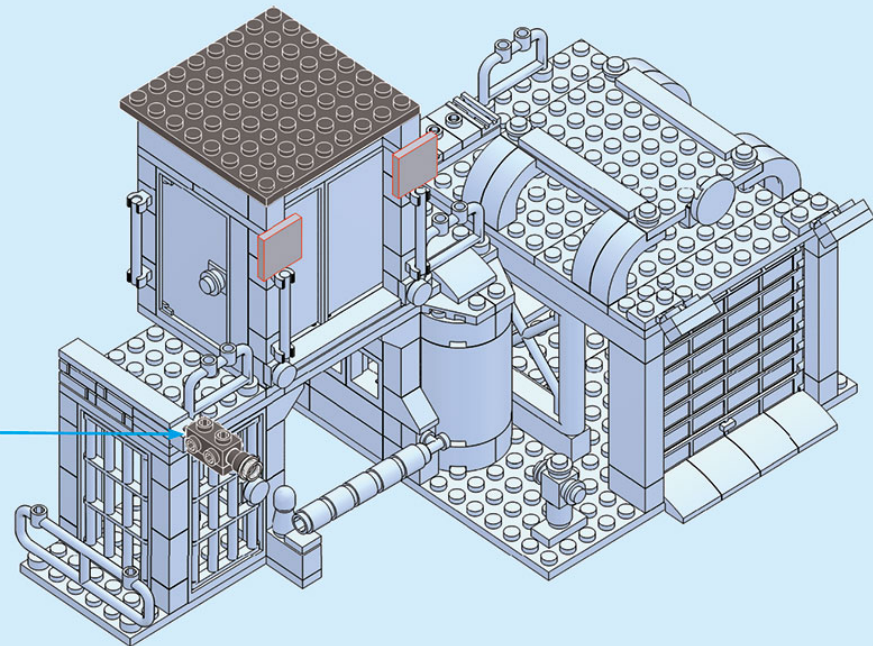
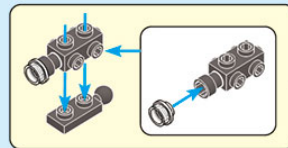

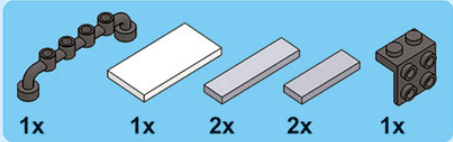

25.

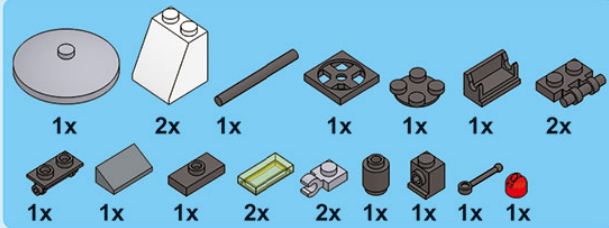
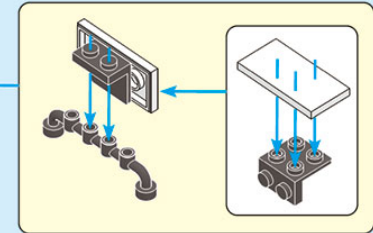
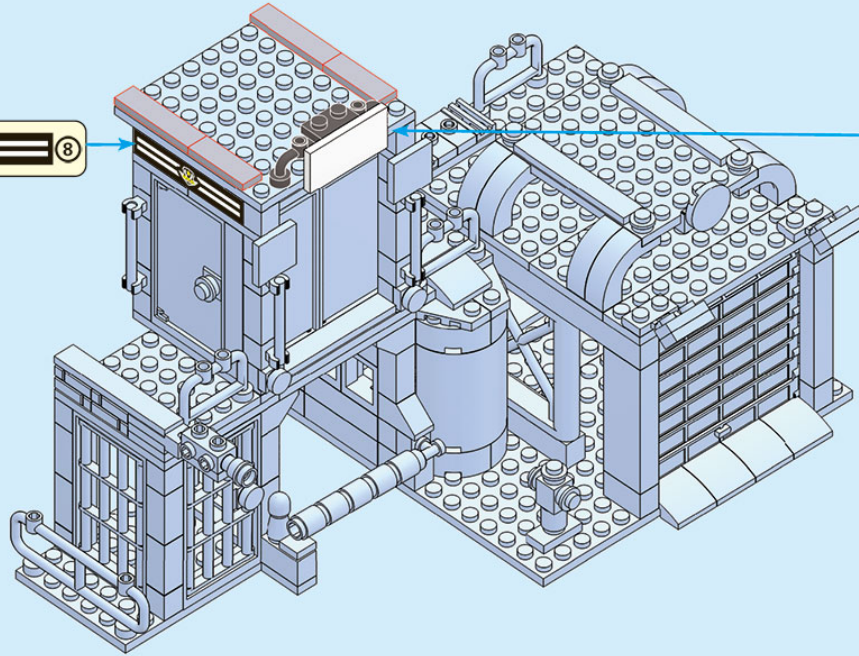

26.

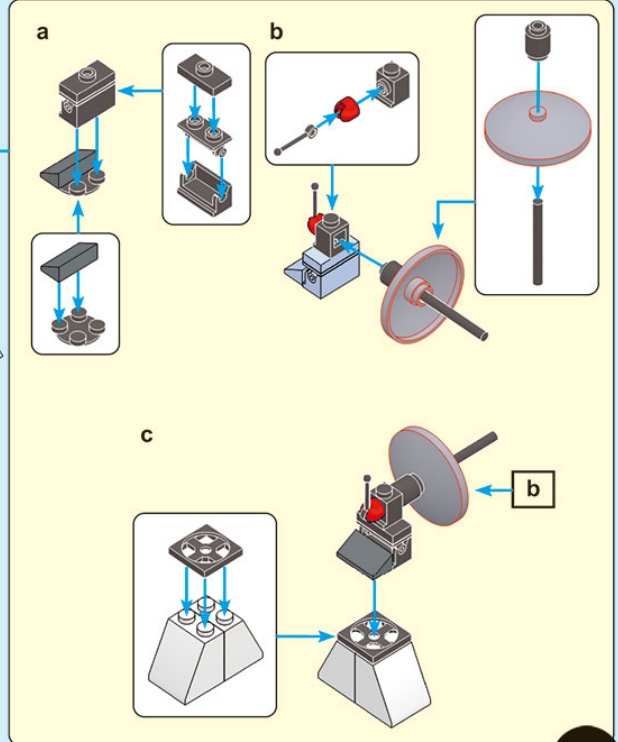
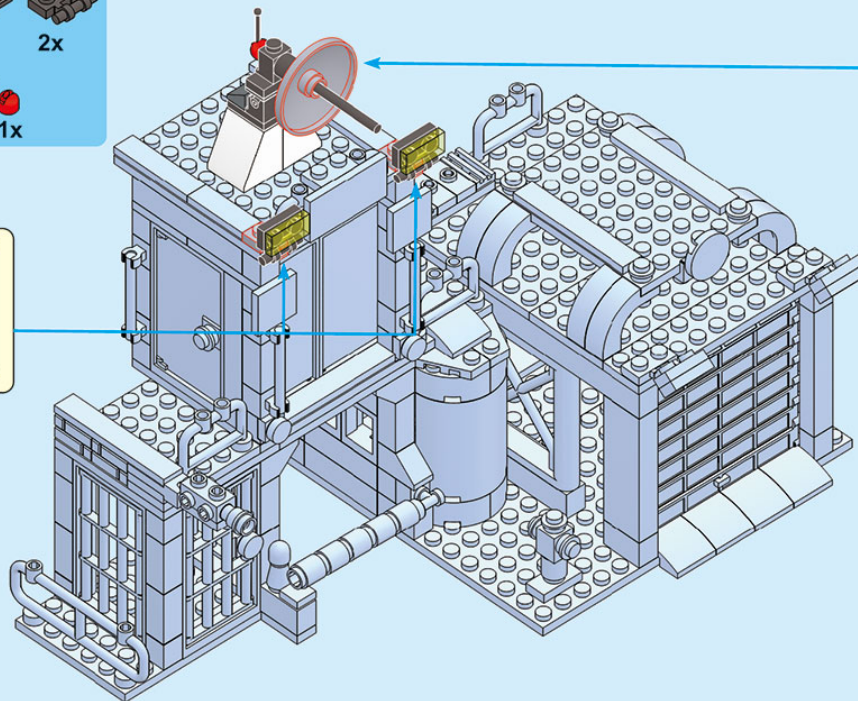
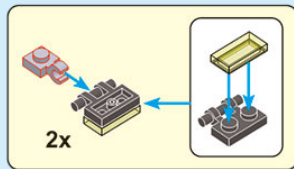

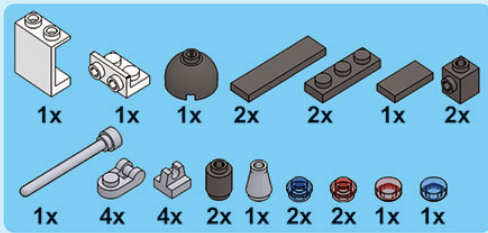

27.

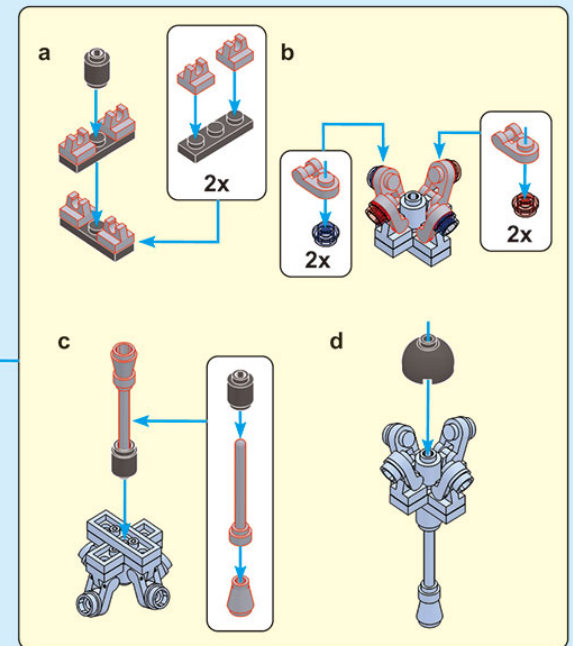
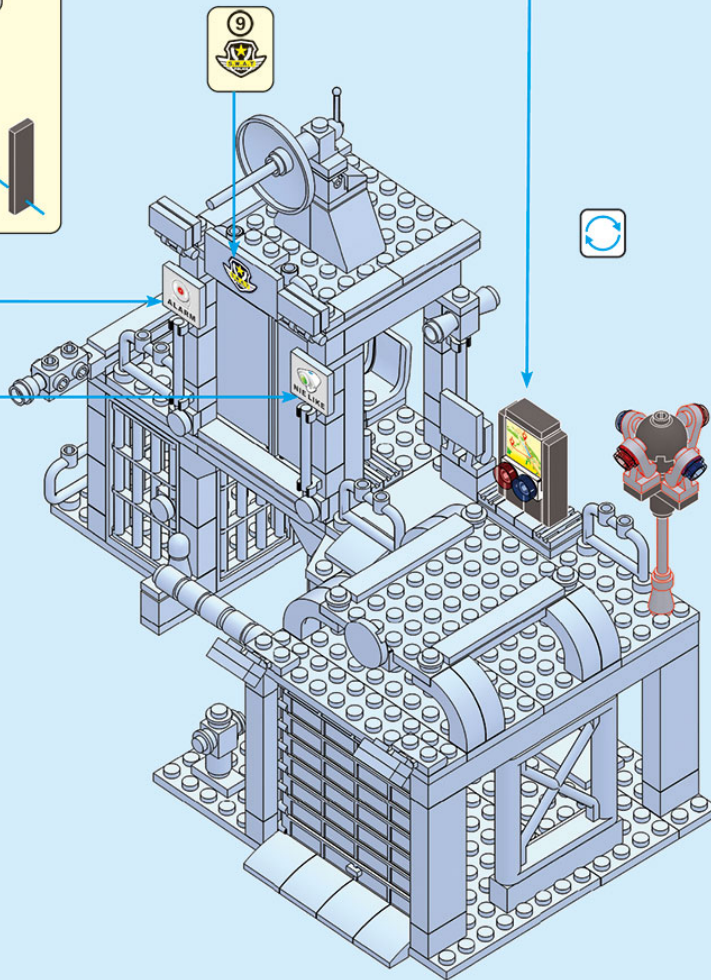
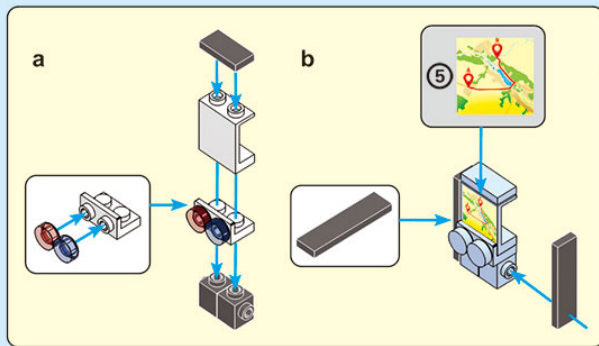

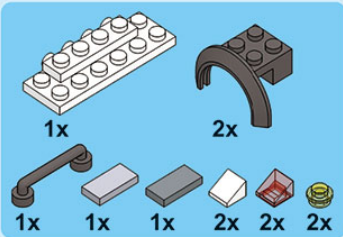
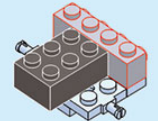
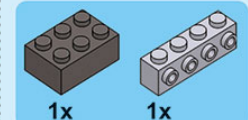
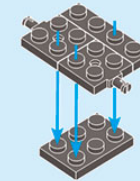
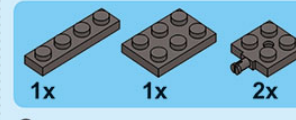
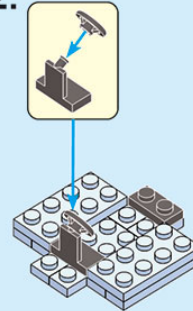
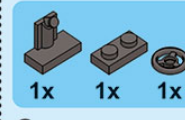
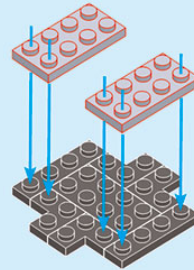
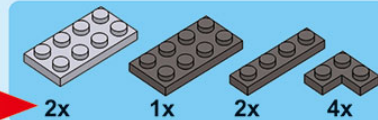
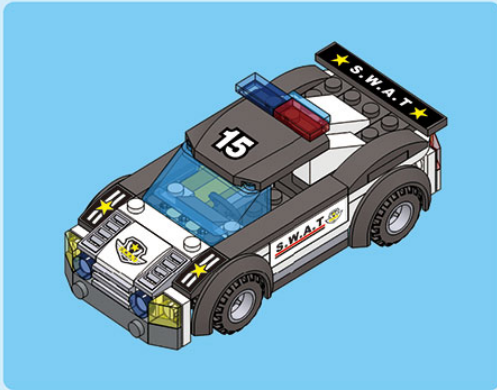

5.

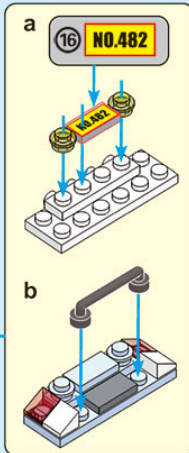
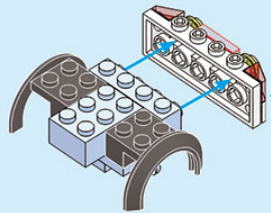

6.

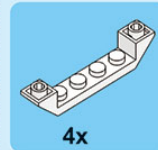
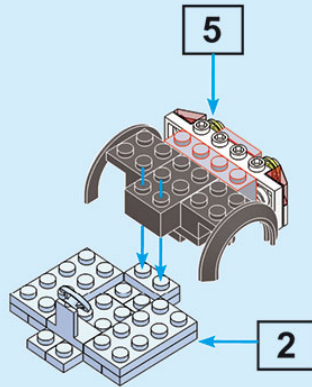

7.

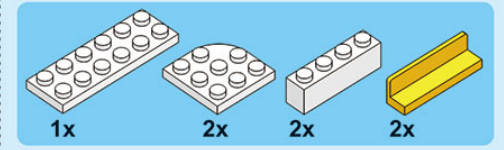
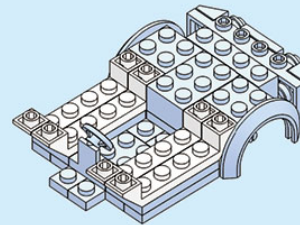

8.

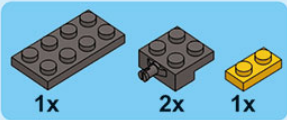
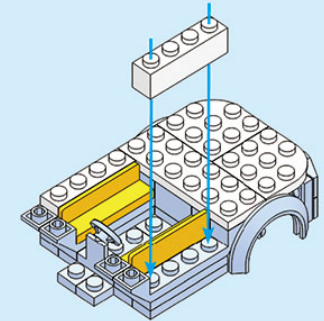

9.

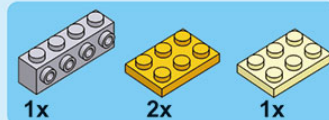
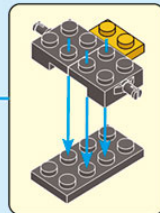
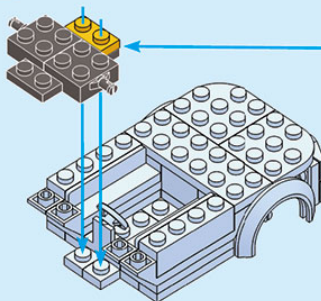

10.

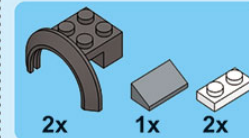
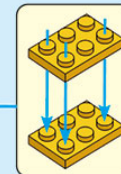
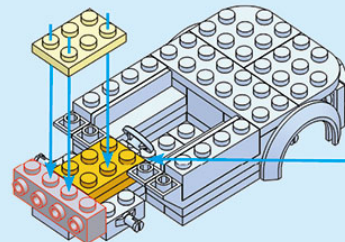

11.

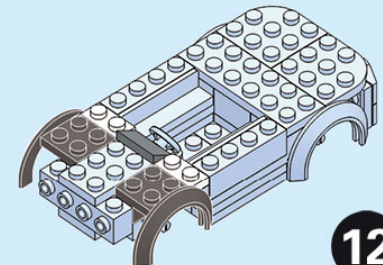



4.

4x 4x

4x

5.

1x 2x 15x

21 Ring

22 Ring

a

b

15x

6

1.

2x 4x 3x

2.

4x 1x 2x

3.

4x 4x 4x

2x 2x 1x 1x

4.

2x 1x

1x 1x 1x

1.

1x 1x

20

19 SWAT

2.

1x 1x 1x 1x 1x

3.

2x 2x

2x

18 SWAT

4.

1x 1x 1x