



EXERCISE & PLAY

UNLIMITED IDEAS

WS4804

Age: 6+

PCS: 948



VACATION TOUR

1

FIRST FORM

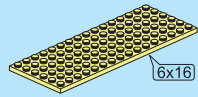

+

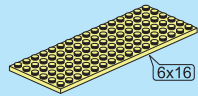

+



=

+



+



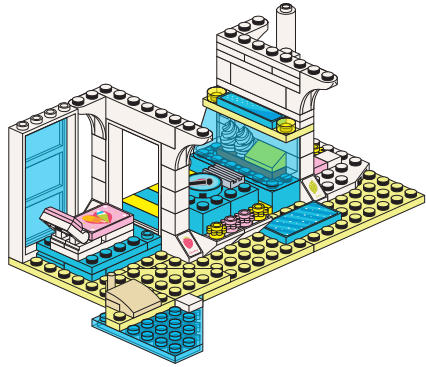

Usage of Brick Separator, Just for the sample

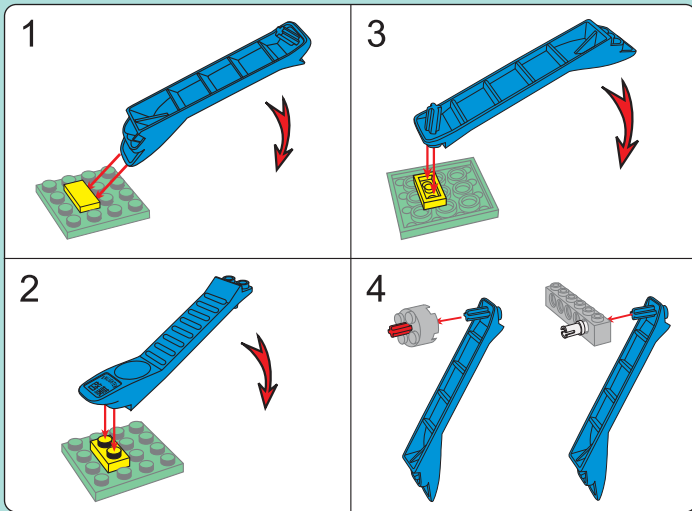

A1

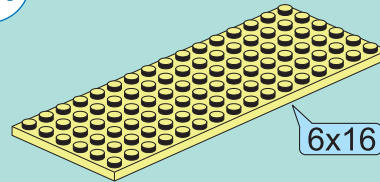

1x

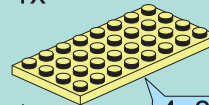

1x

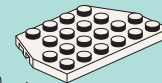

1x

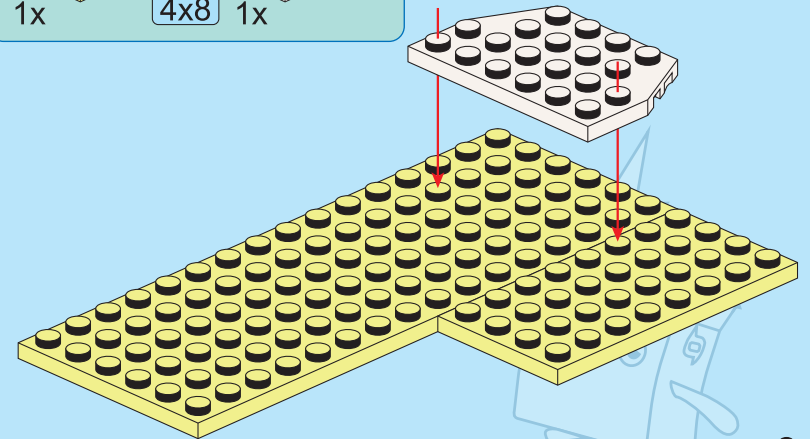

A2

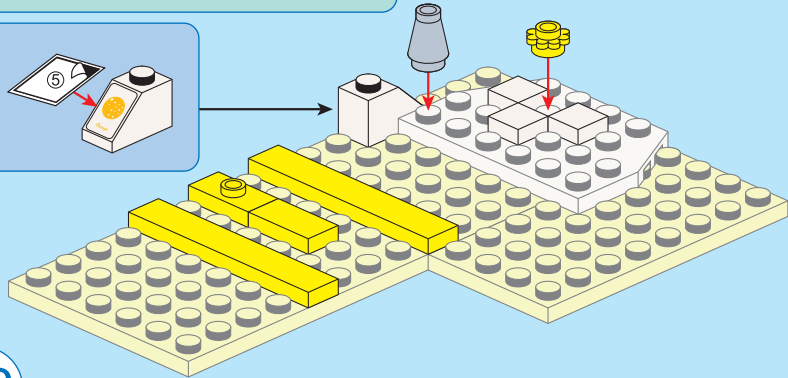
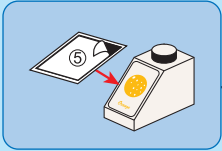
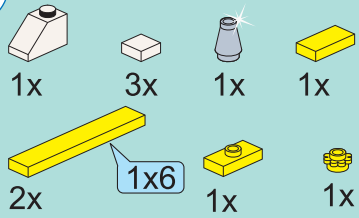

A3

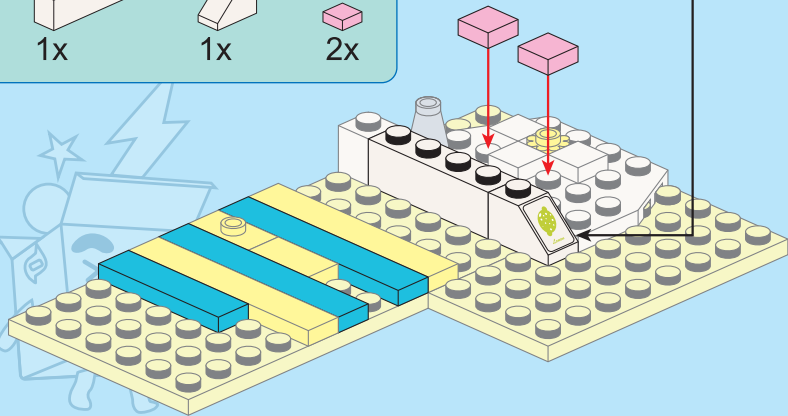
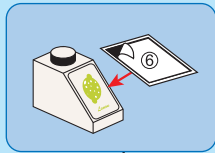
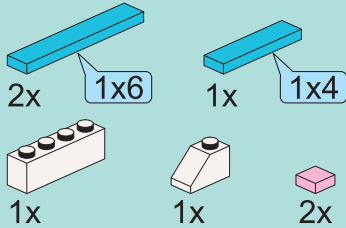

A4

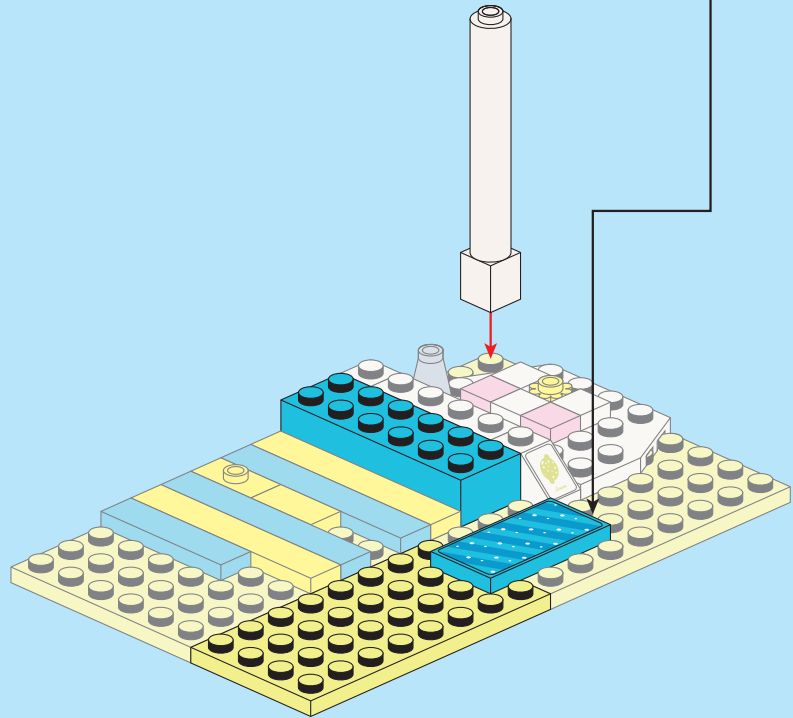
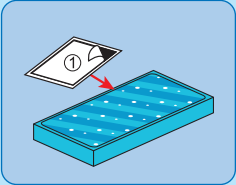
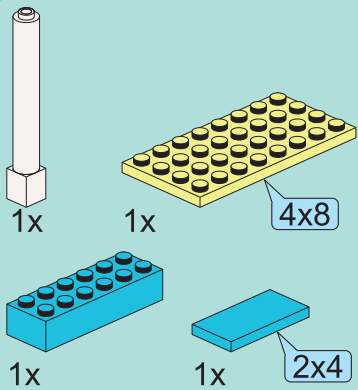

A5

- 1x
- 2x
- 1x
- 1x
- 1x
- 1x

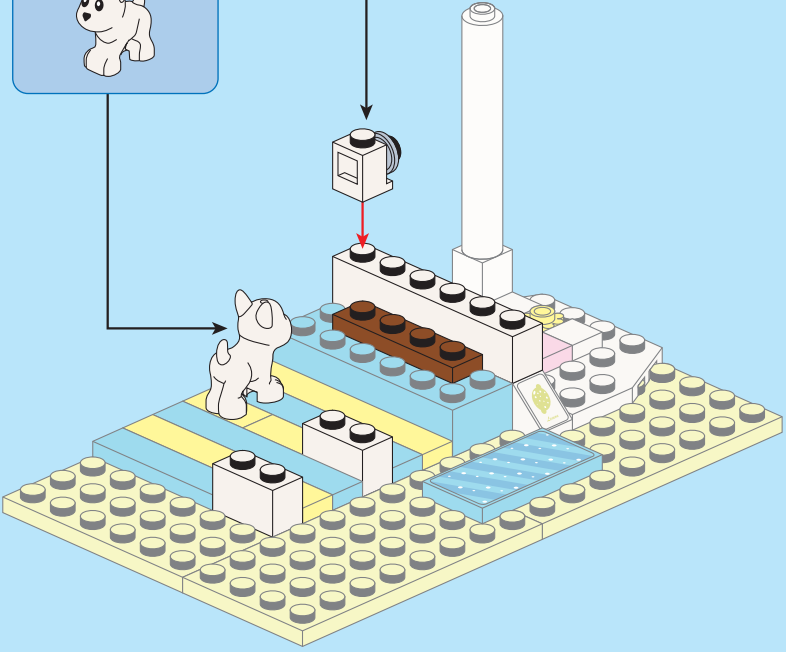
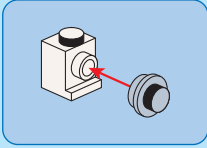

A6

- 2x
- 1x
- 2x
- 1x

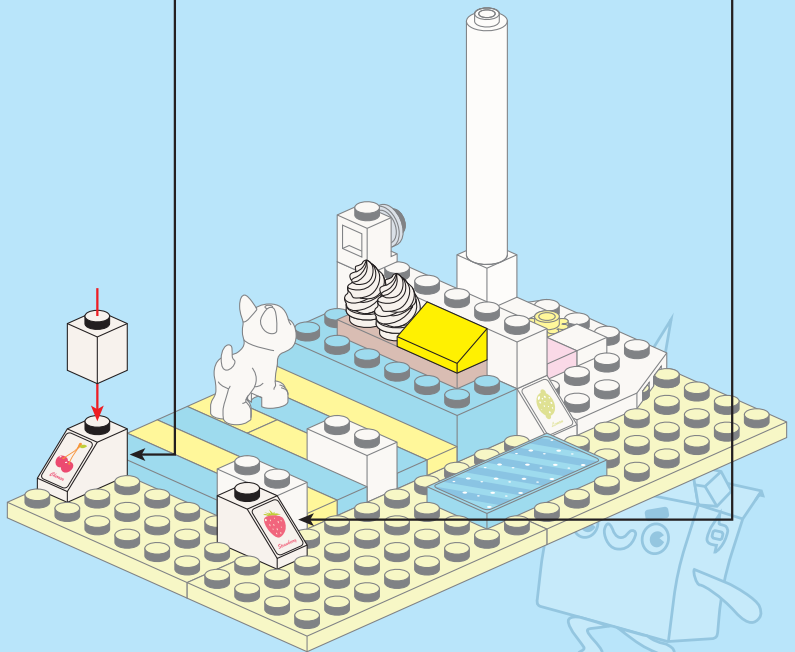
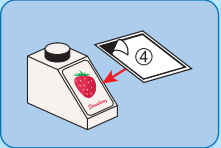
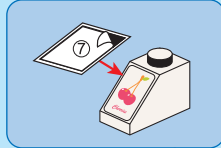

A7

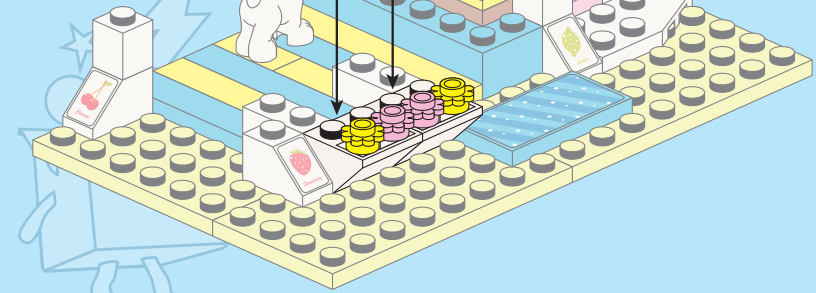
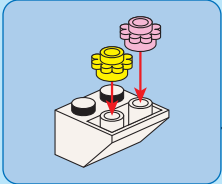
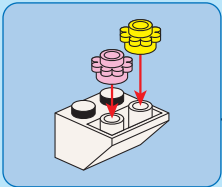
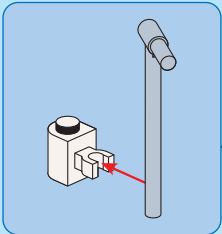
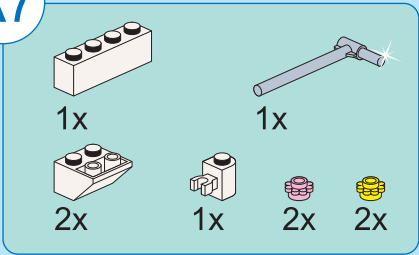

A8

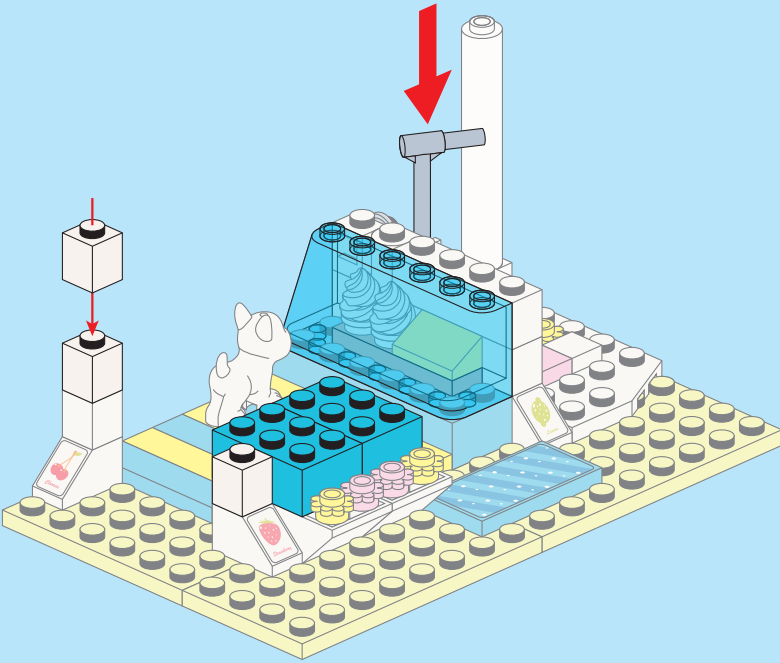
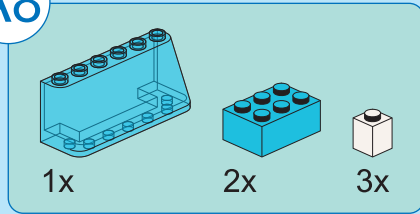

A9

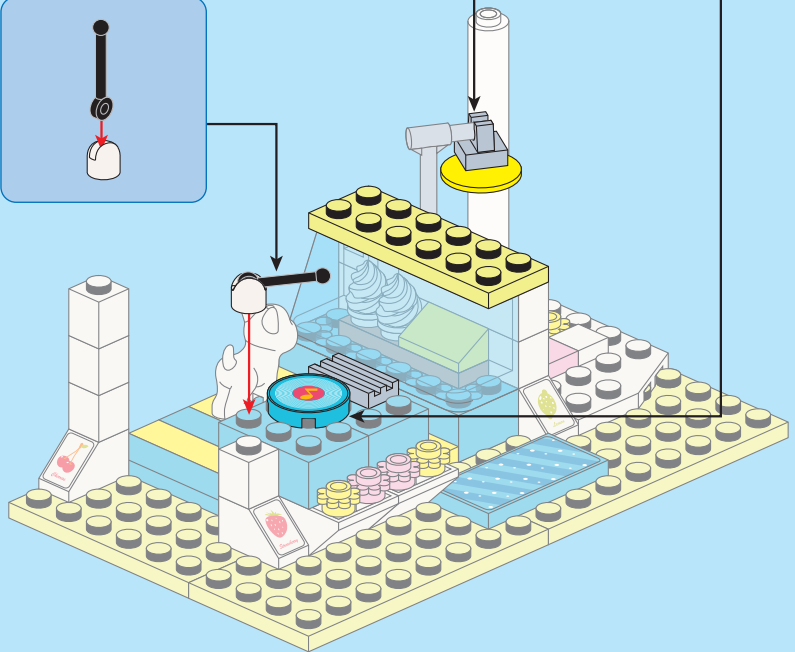
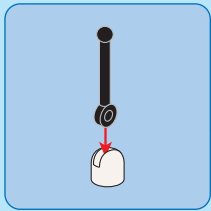
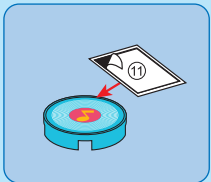
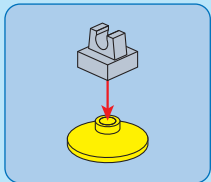
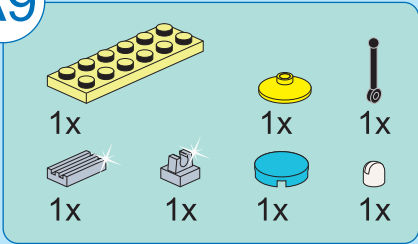

A10

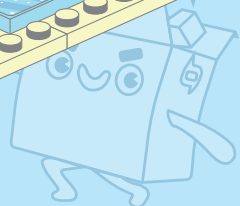
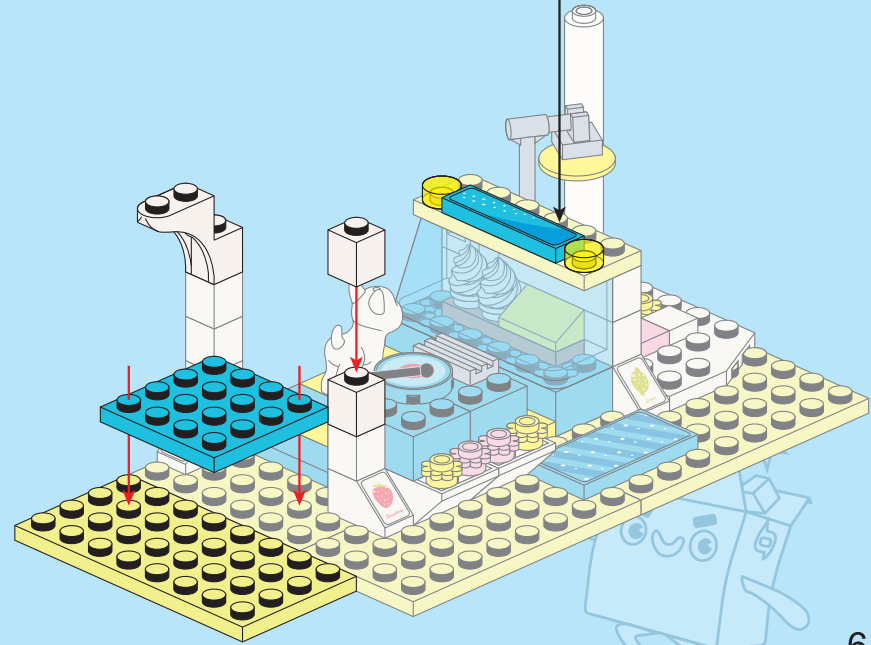
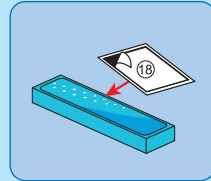
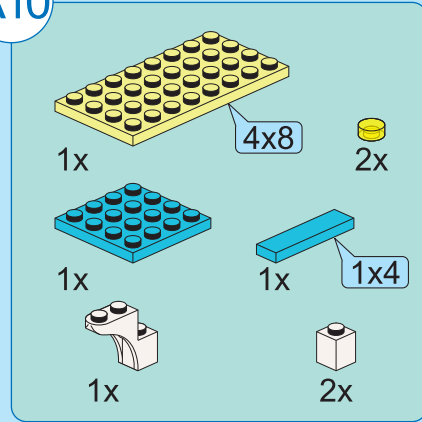

A11

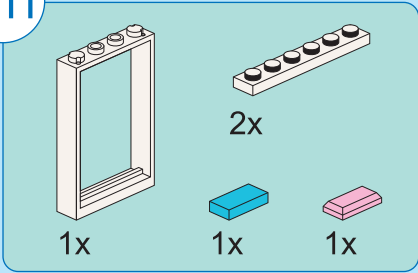

A12

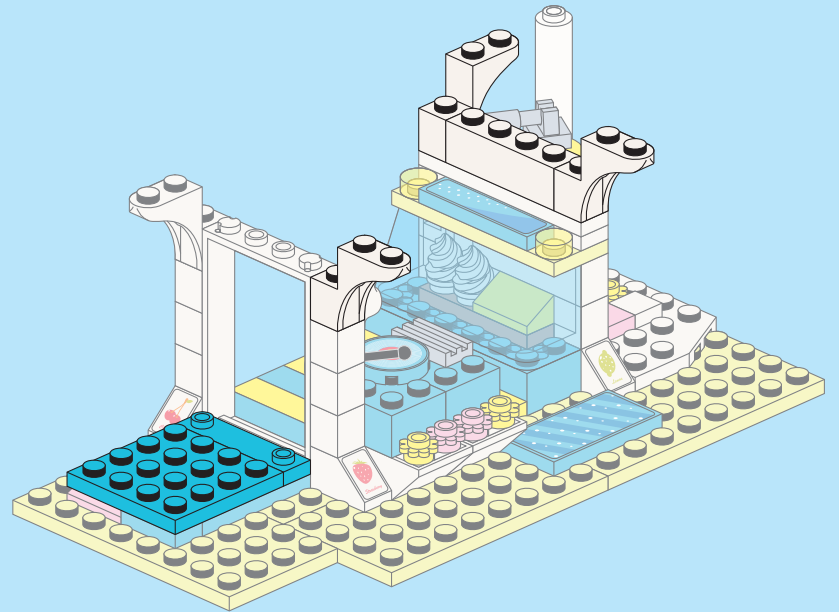
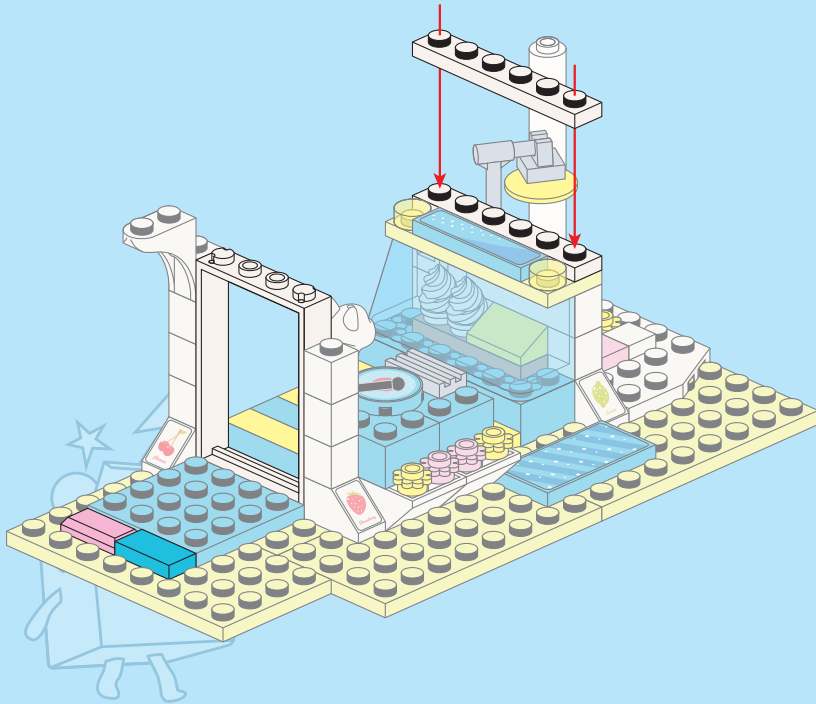
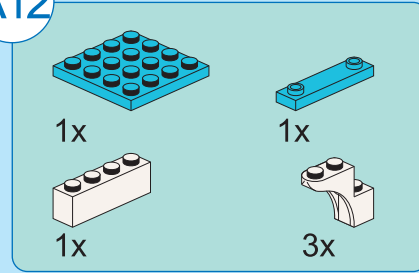

A13

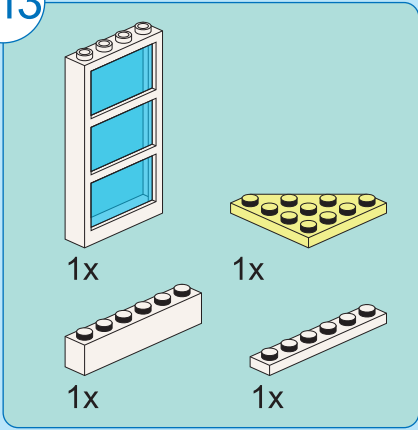

A14

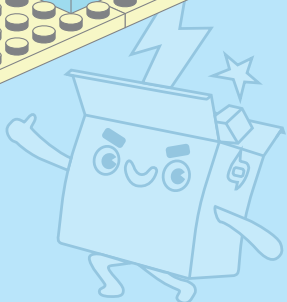
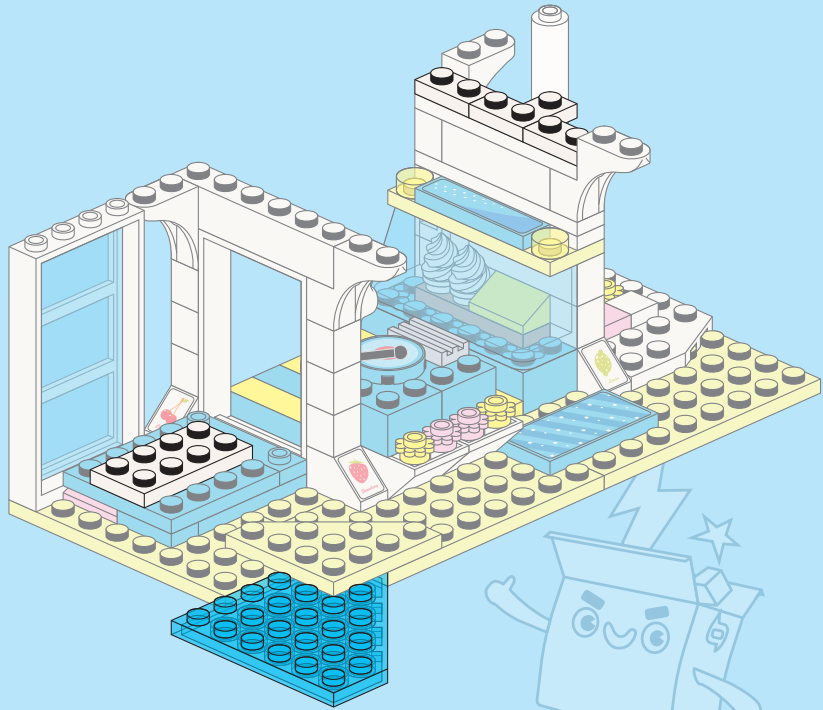
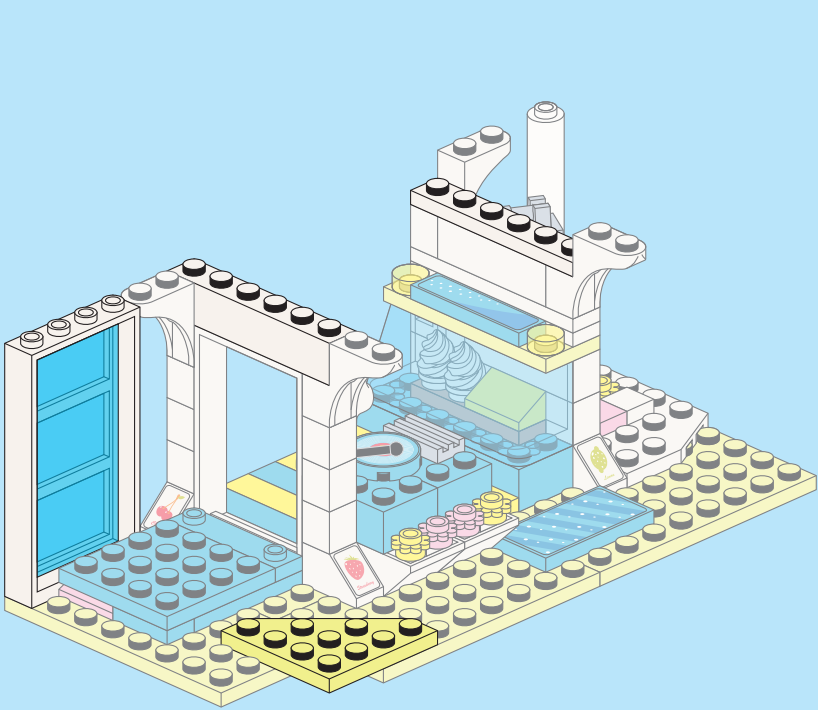
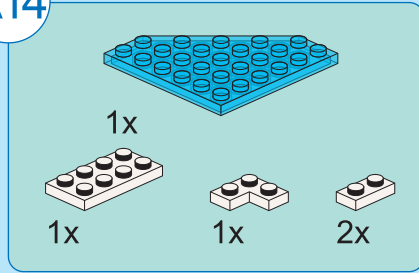

A15

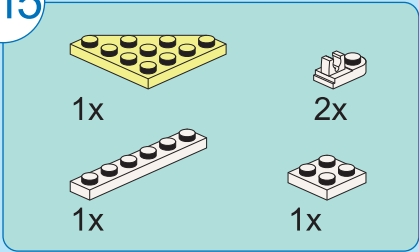

A16

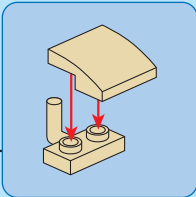
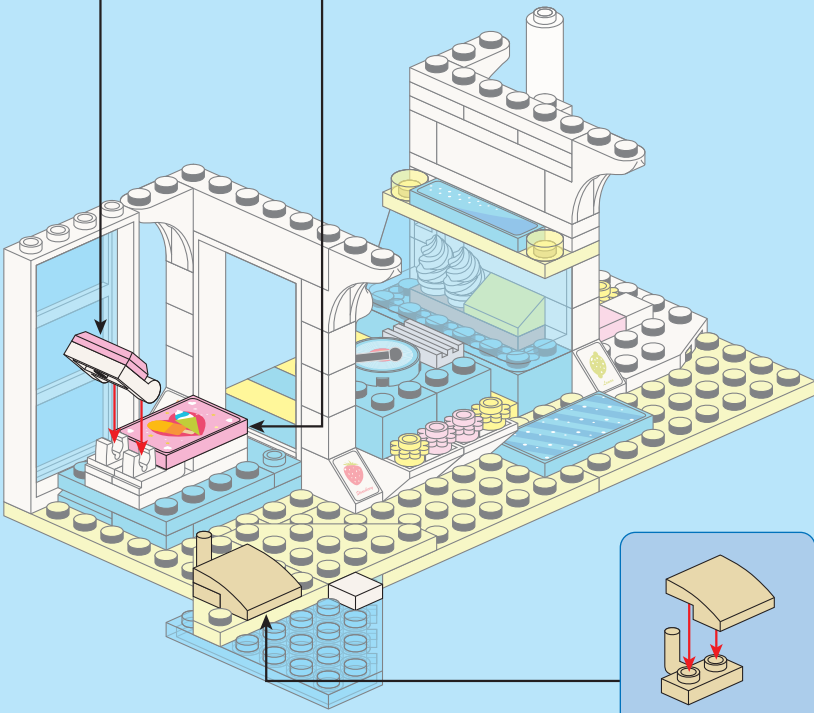
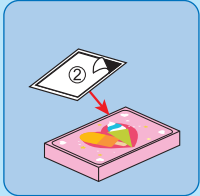
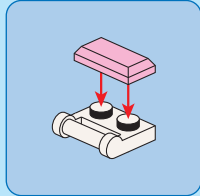
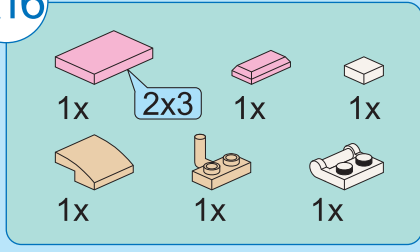

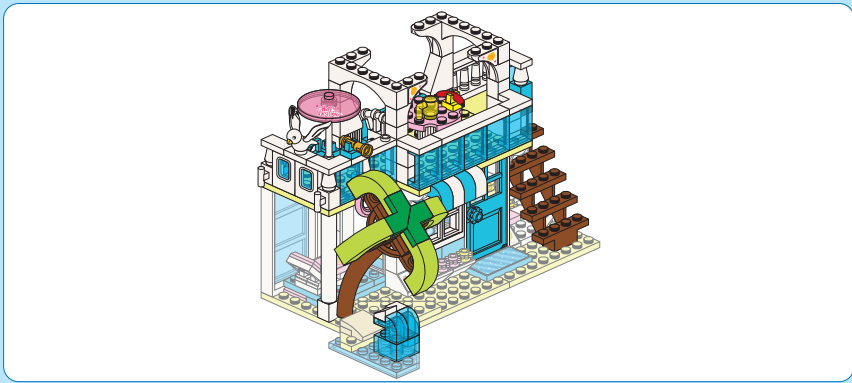

A17

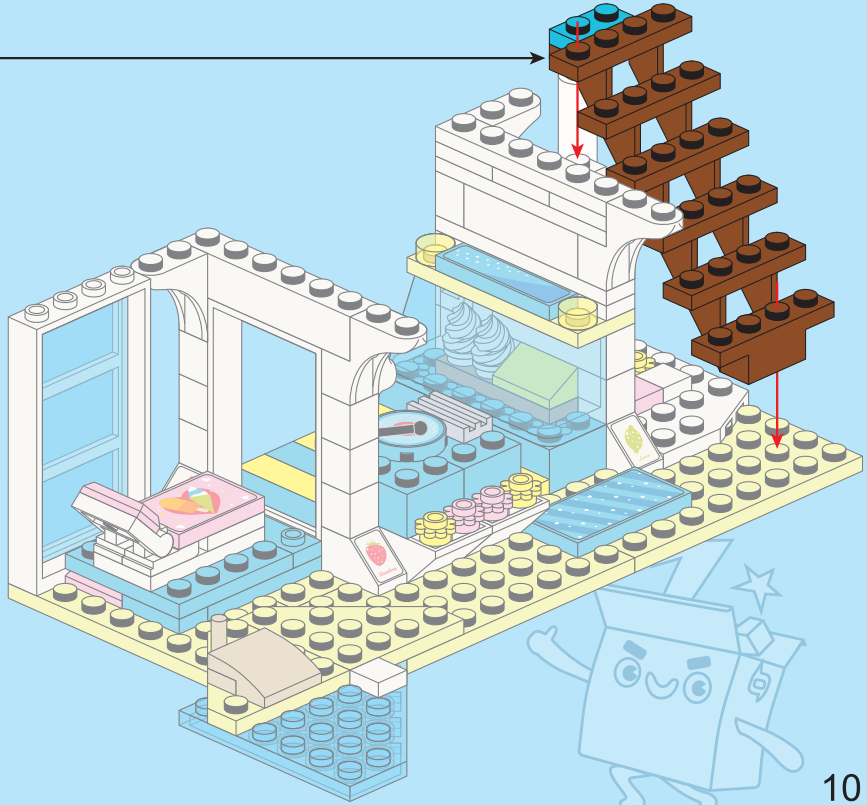
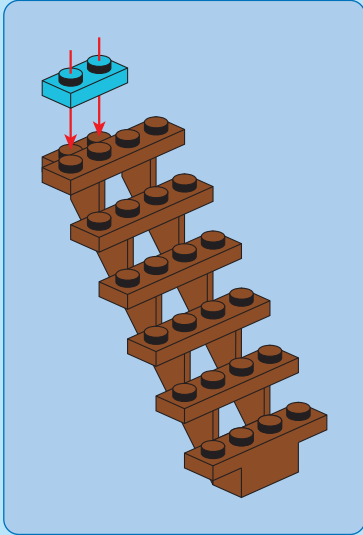
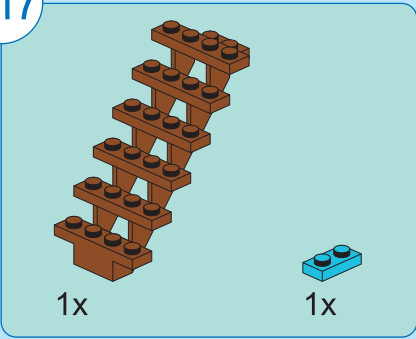

A18

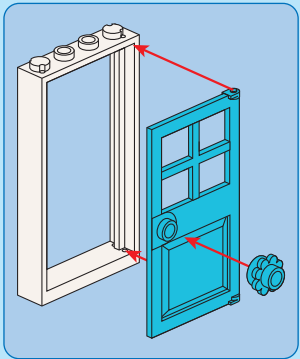
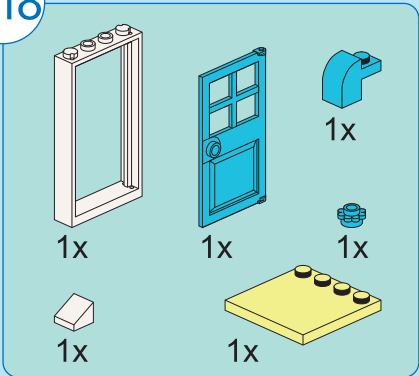

A19

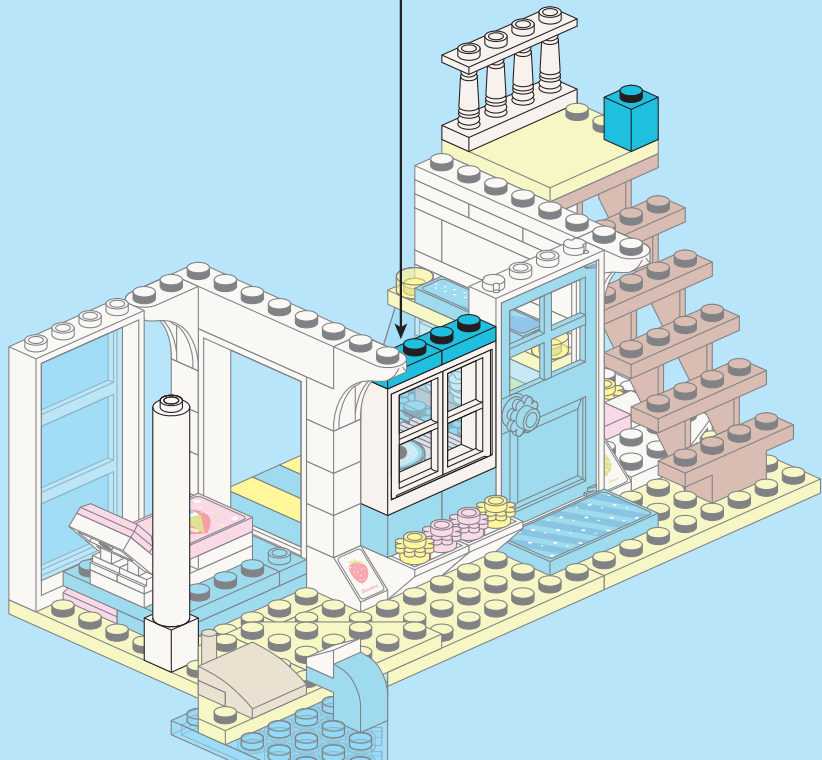
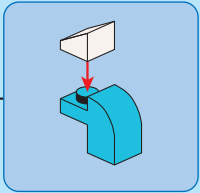
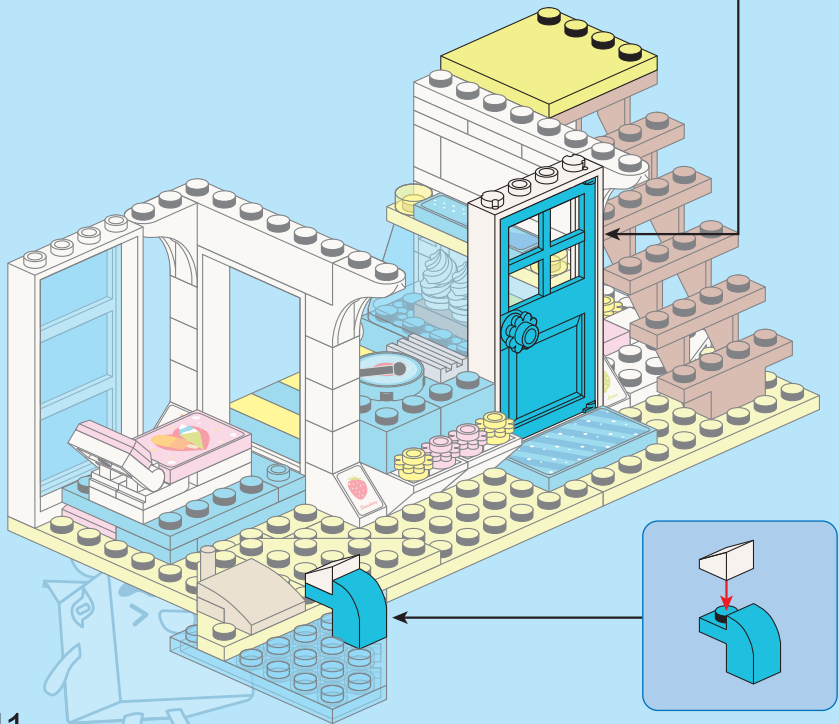
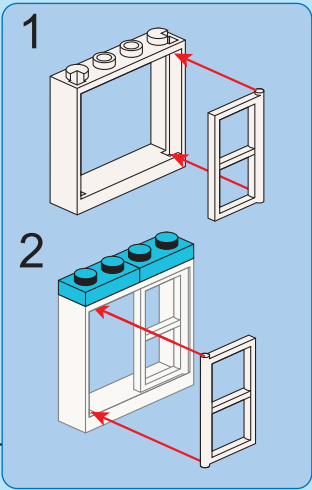
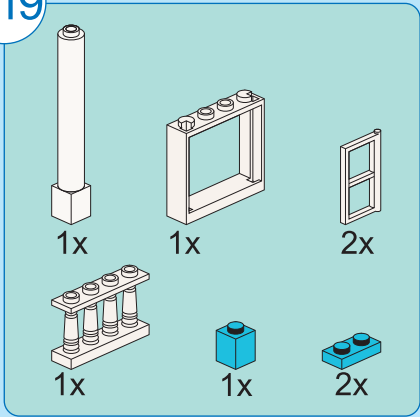

A20

1x	1x	2x
2x	1x	1x
2x	2x	

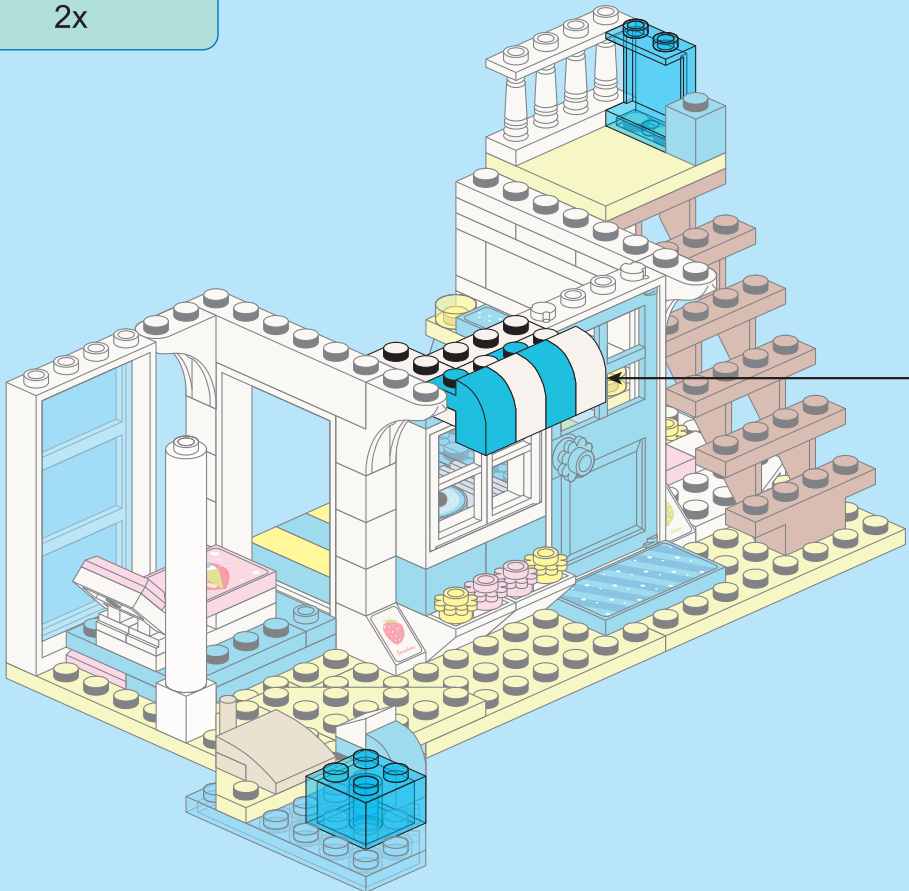

1

2x

2

3



A21

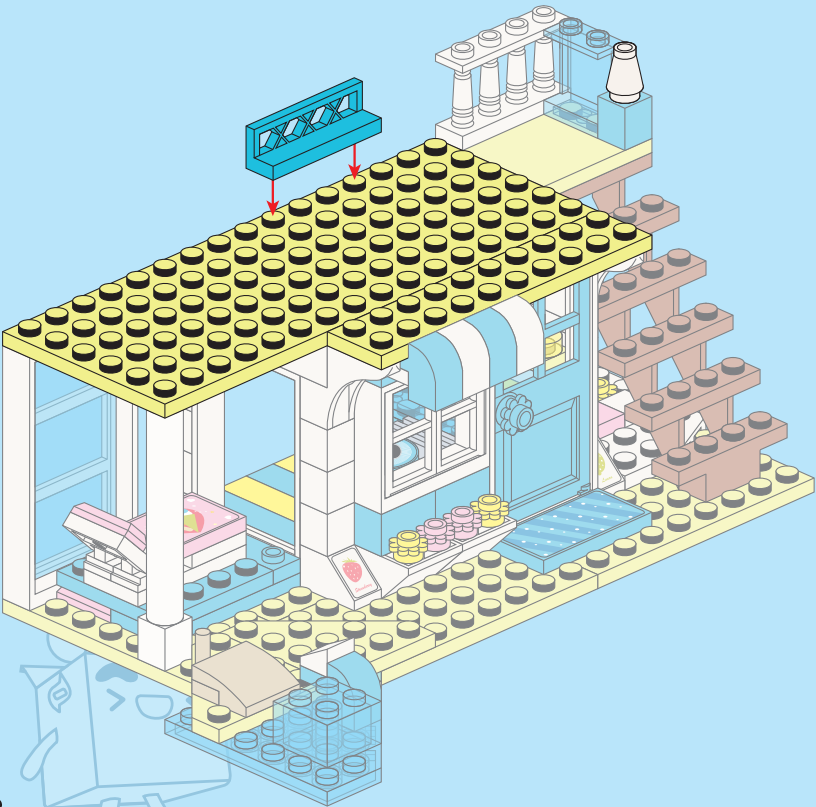
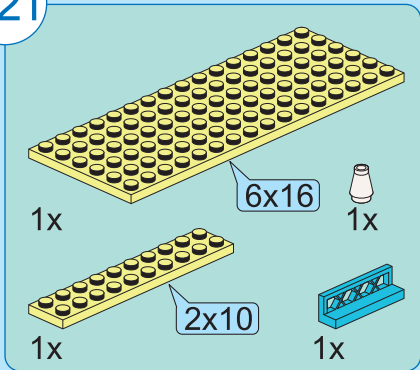

A22

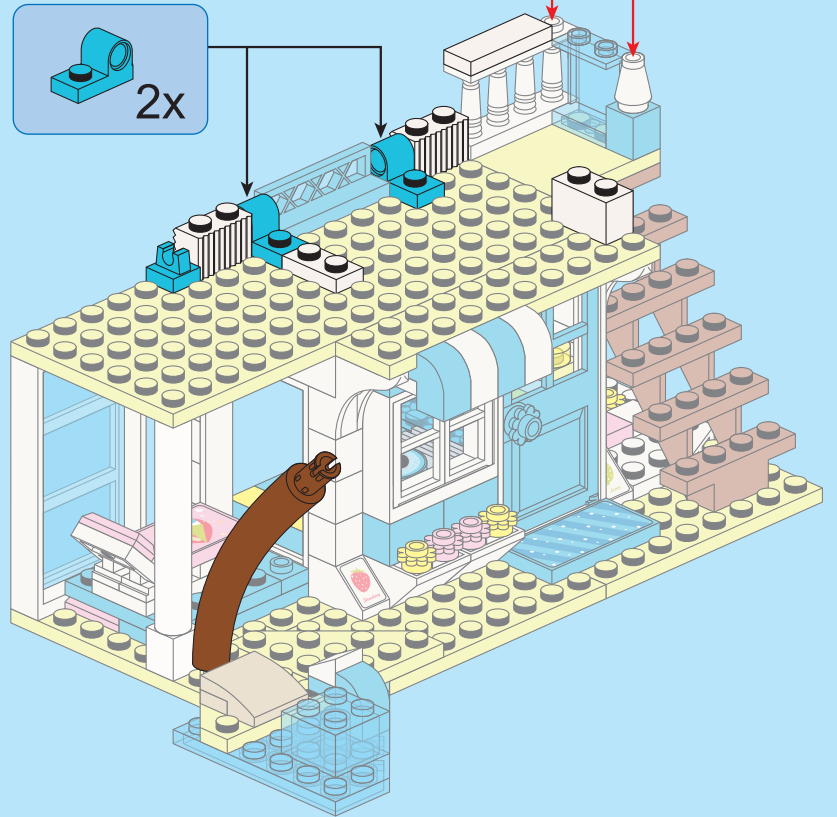
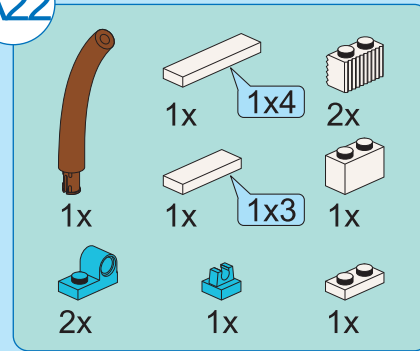

A23

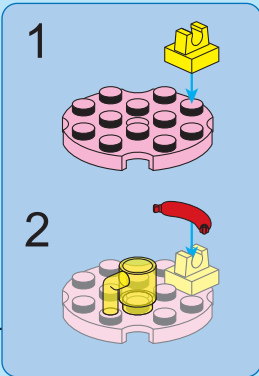
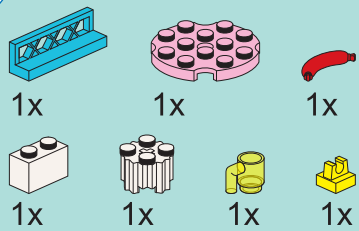

A24

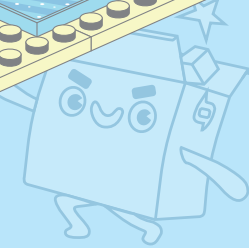
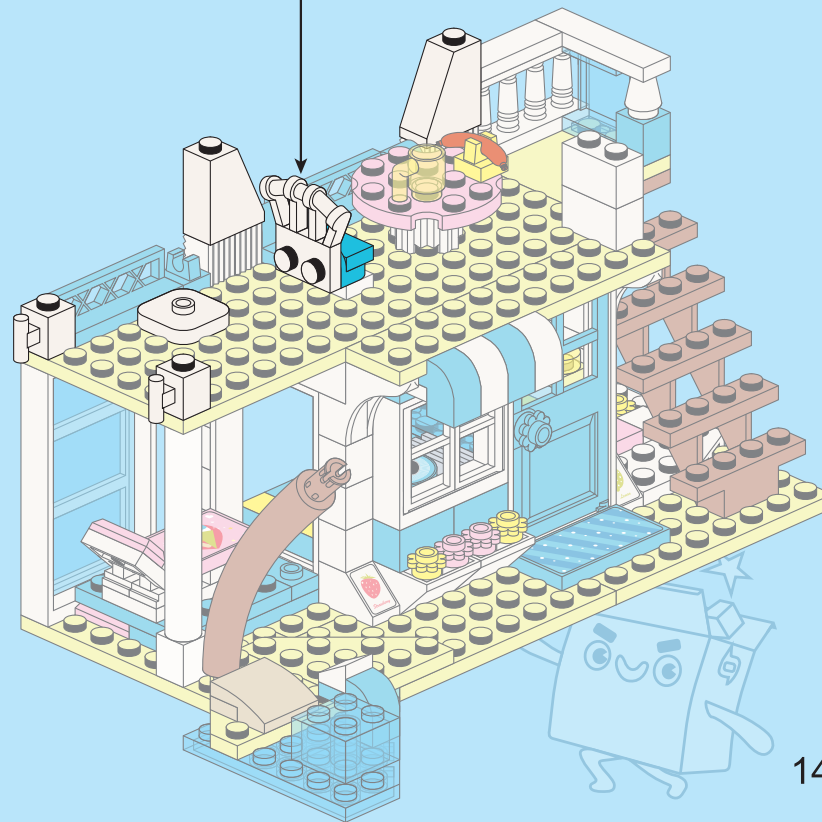
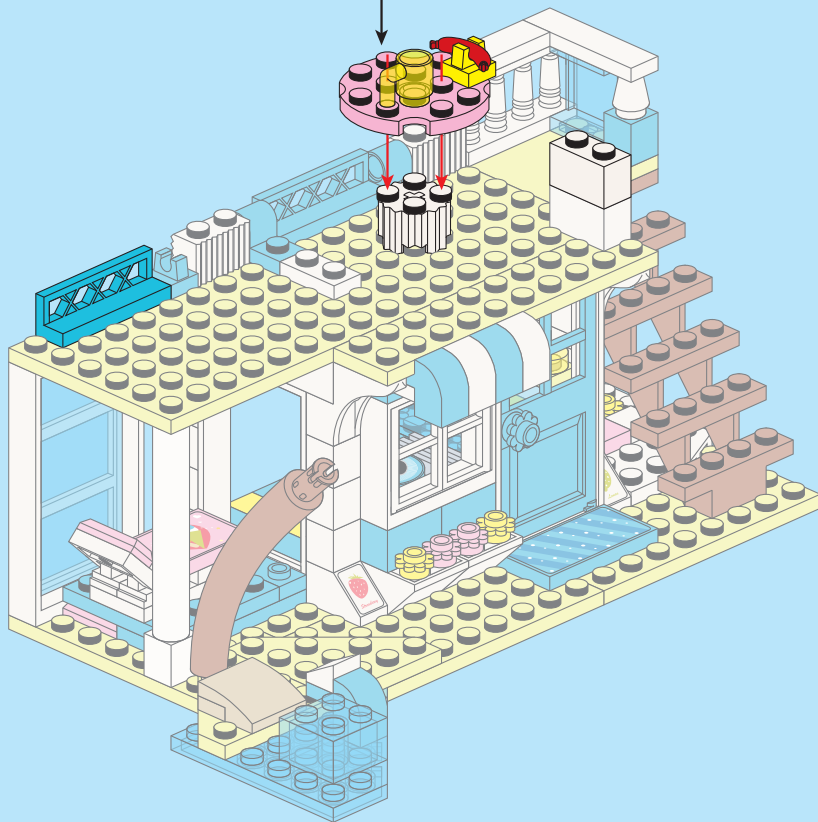
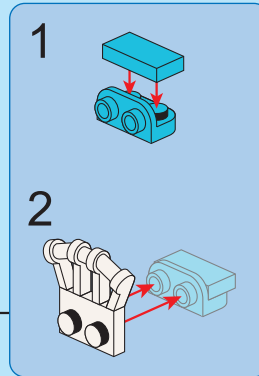
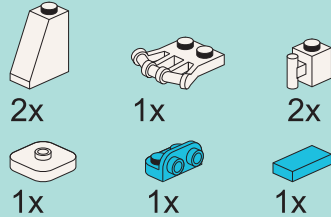

A25

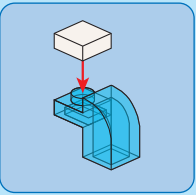
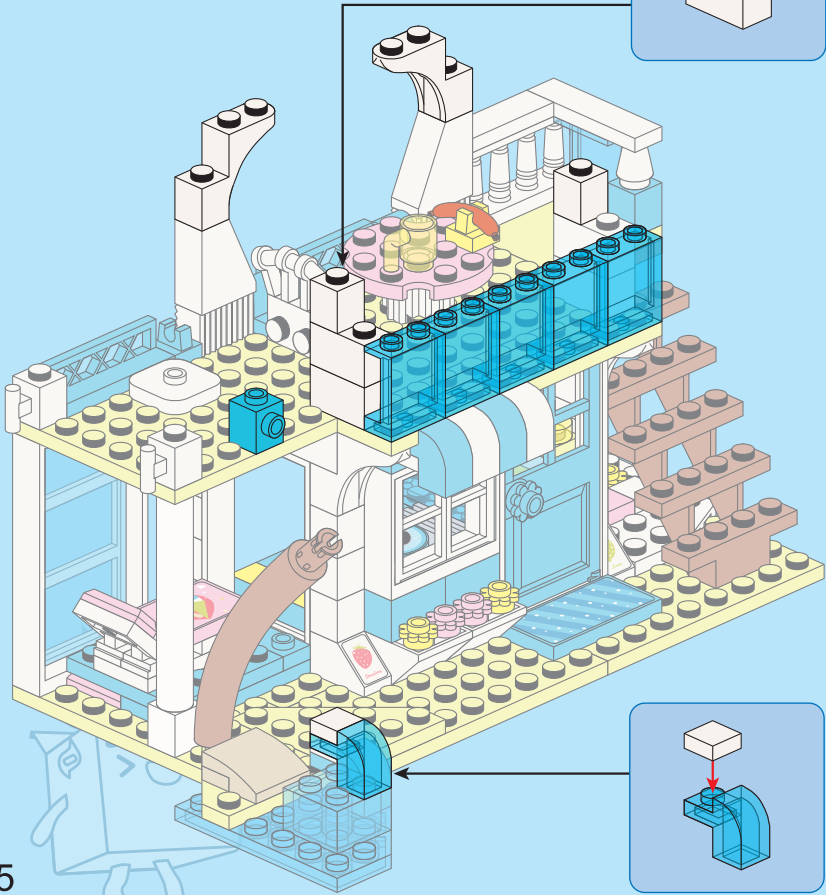
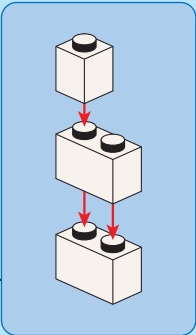
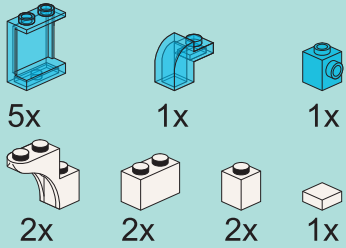

A26

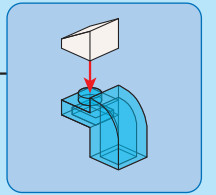
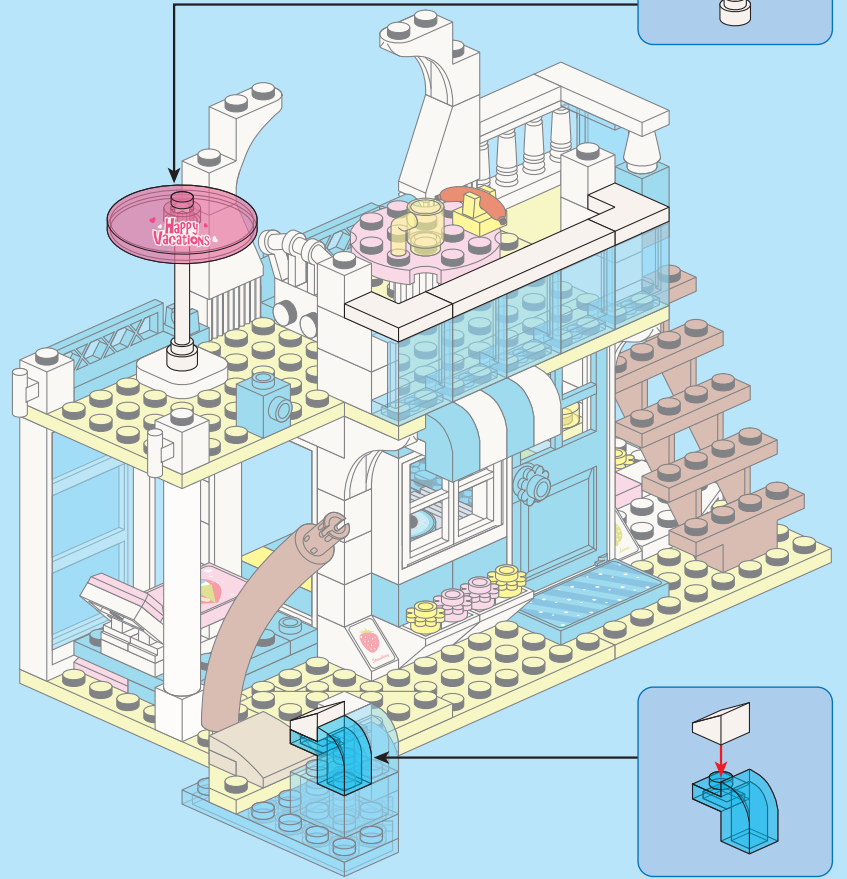
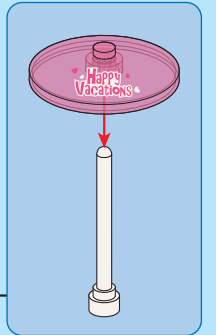
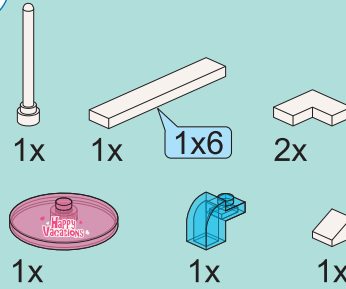



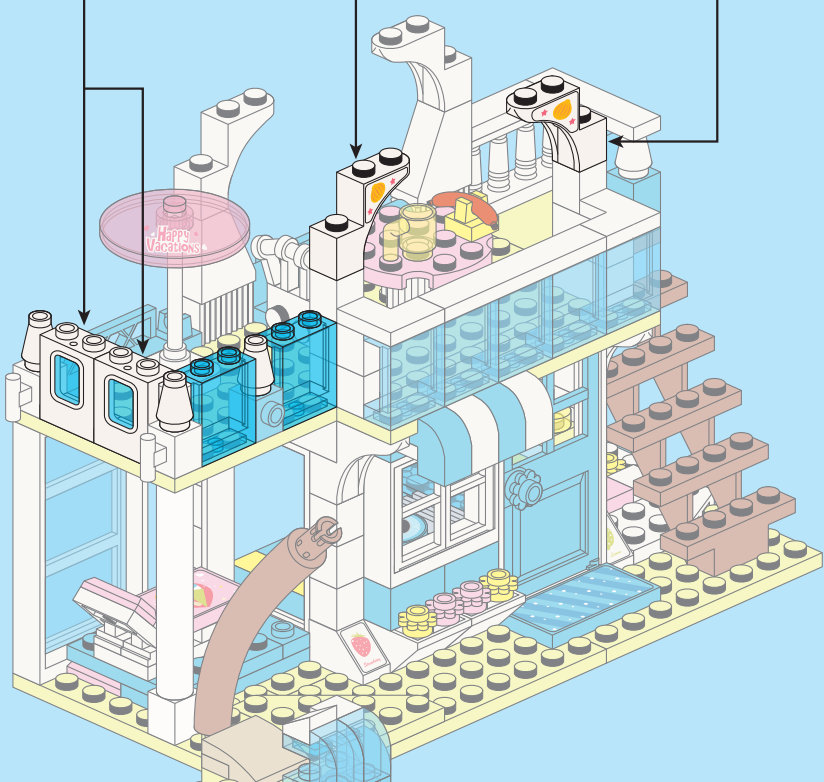
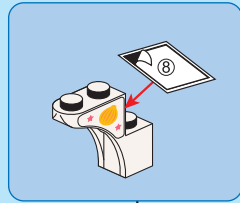
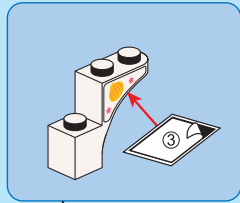
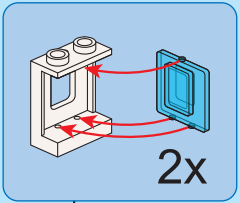
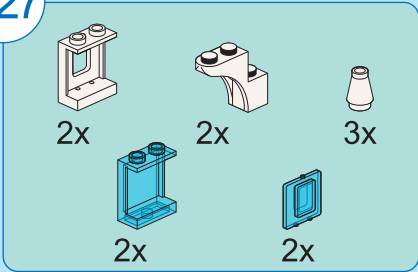



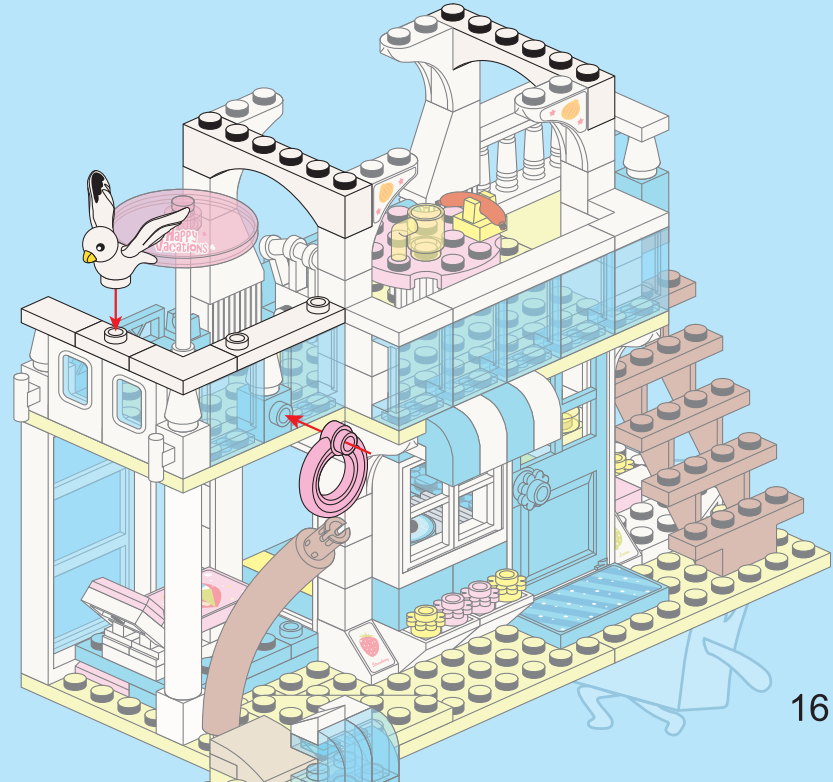
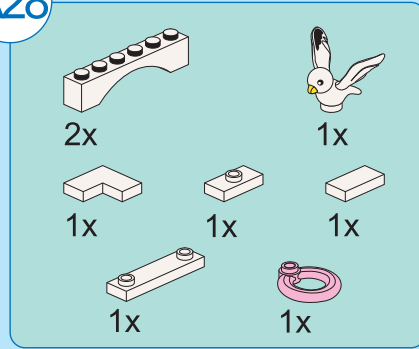

A27



A28



A29

 1x	 2x	 4x
 4x	 1x	 1x
	 1x	 2x

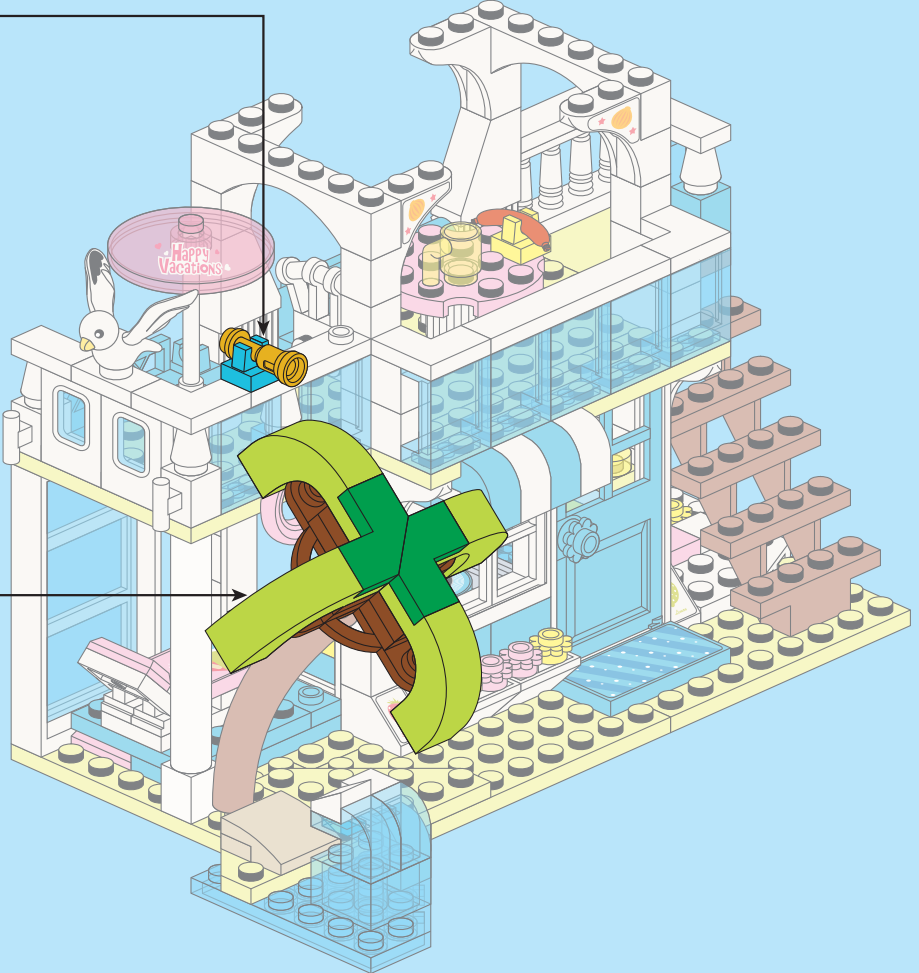
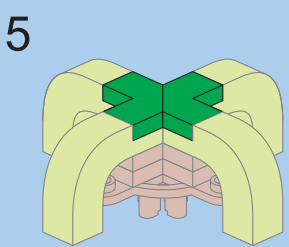
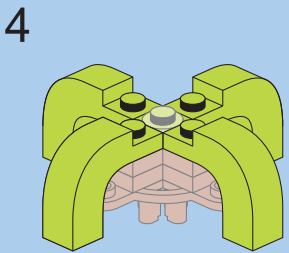
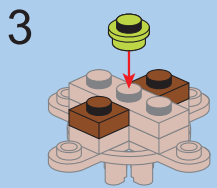
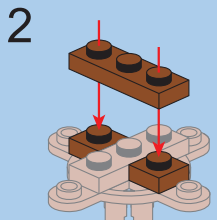
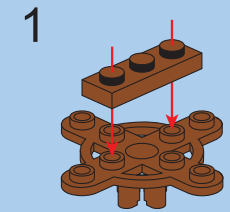
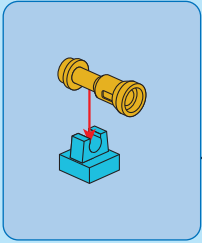

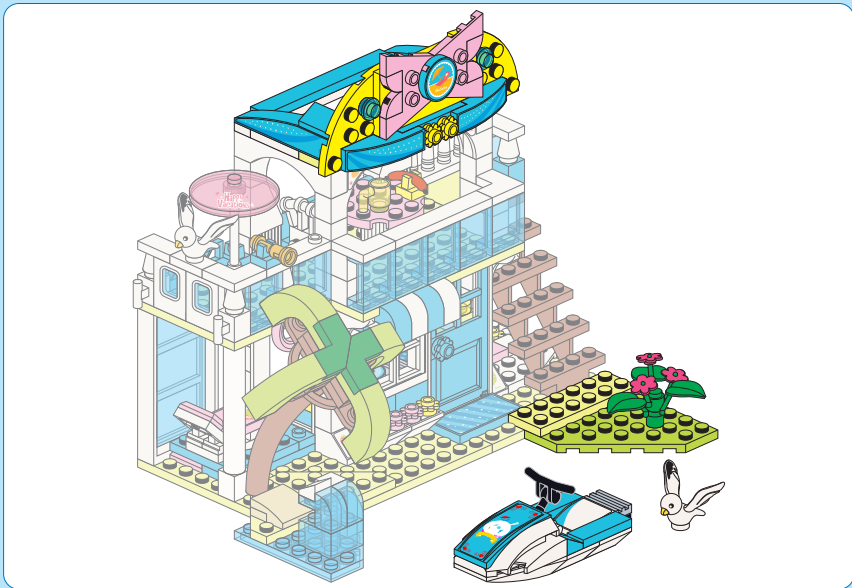

A30

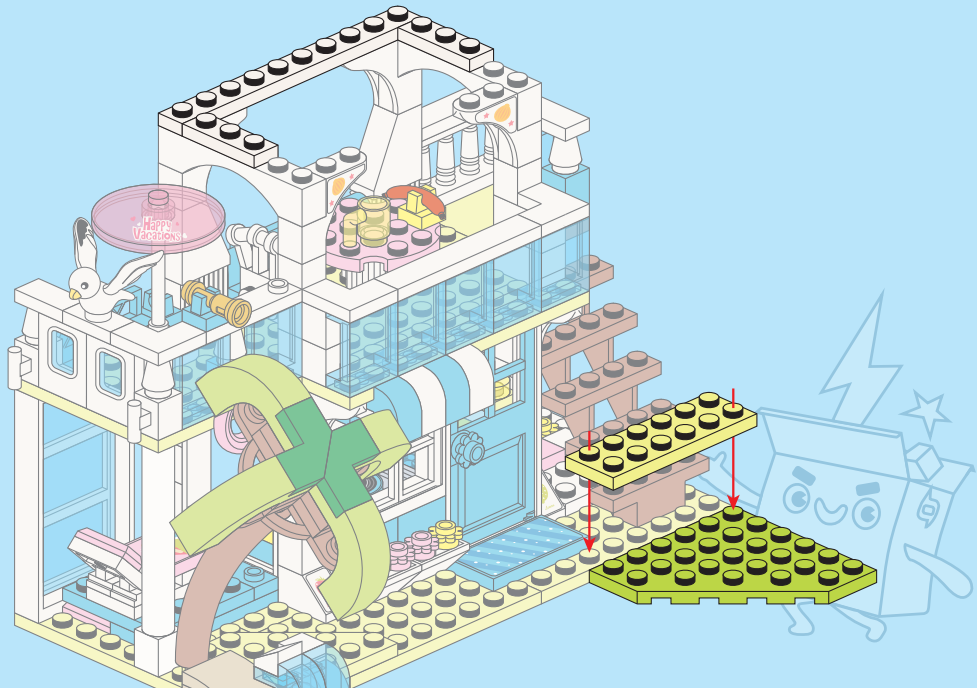
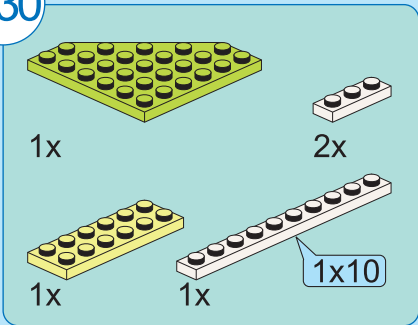

A31

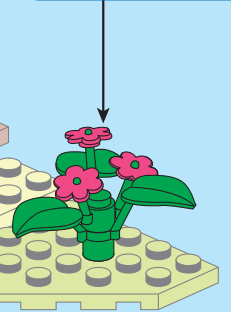
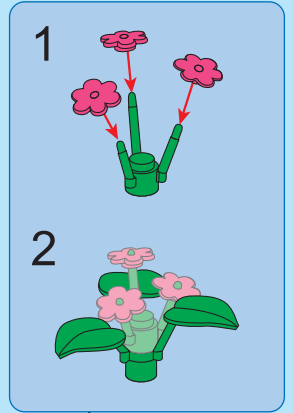
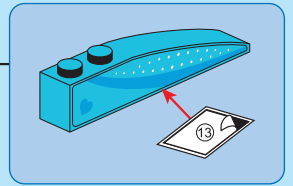
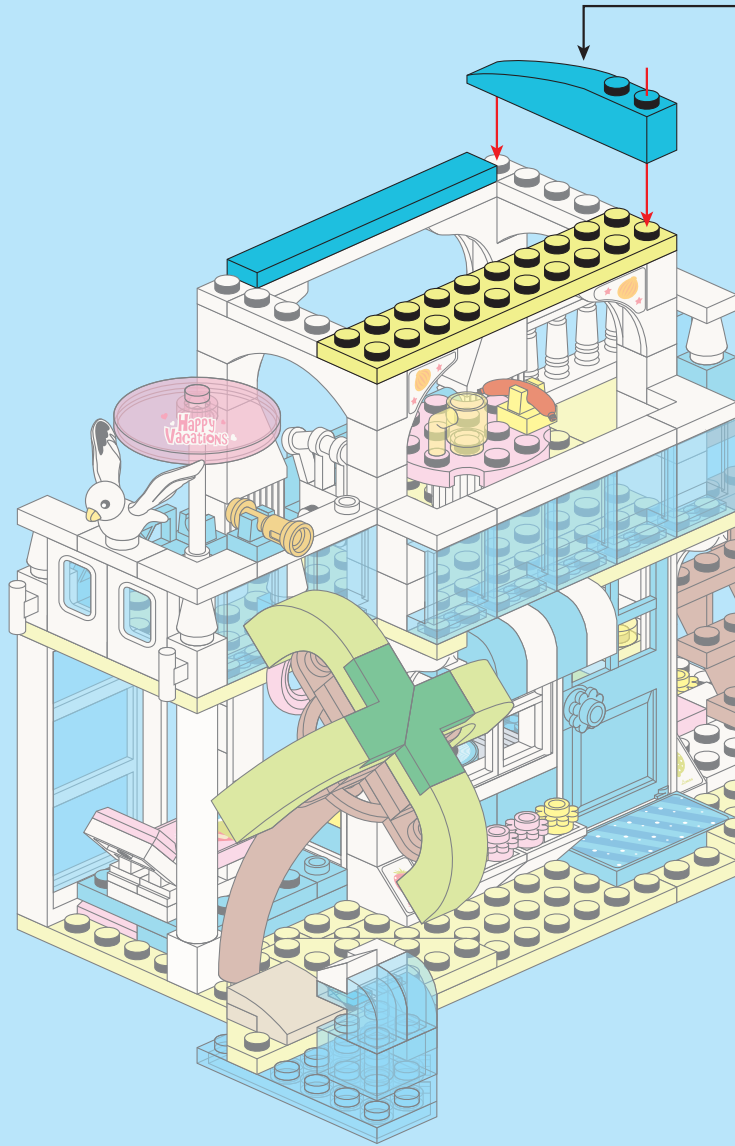
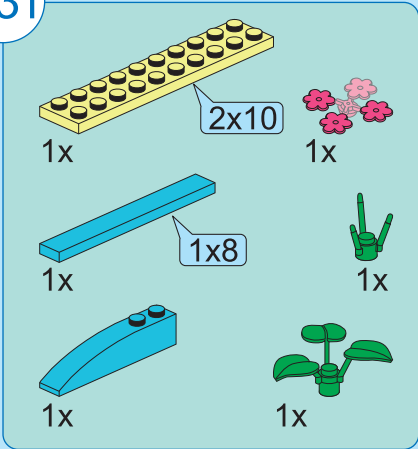

A32

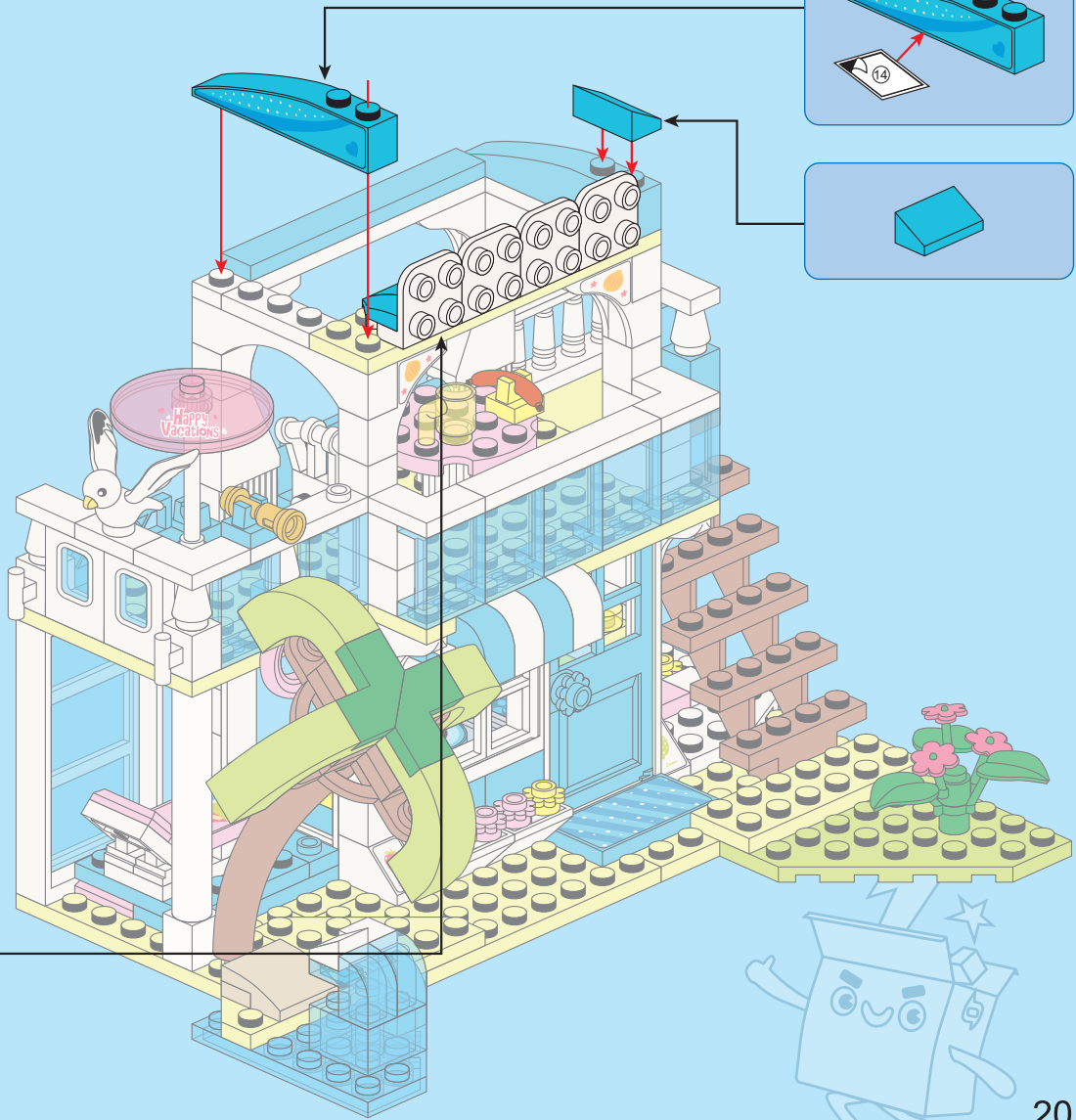
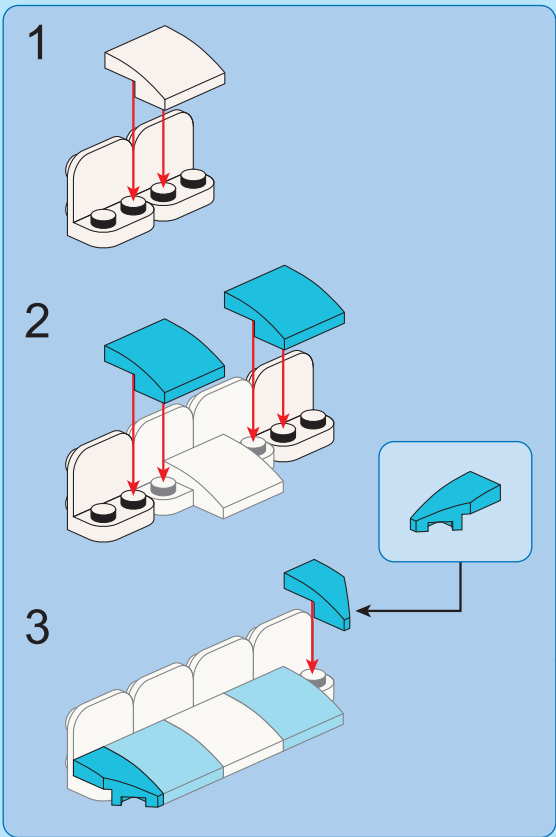
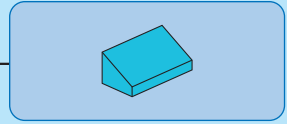
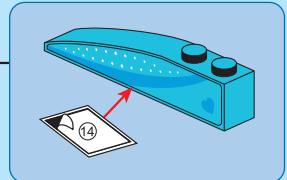
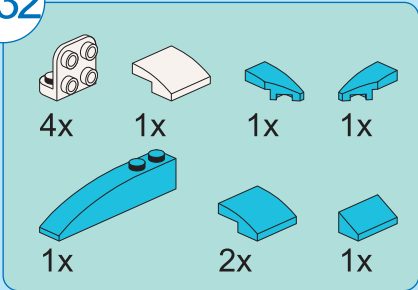

- 1x
- 2x
- 2x
- 4x
- 2x
- 2x
- 2x
- 2x
- 1x
- 1x
- 1x

1

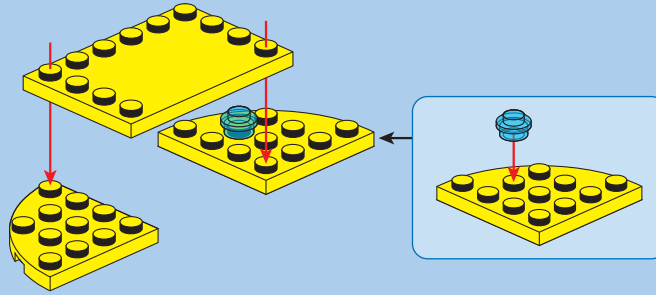

2

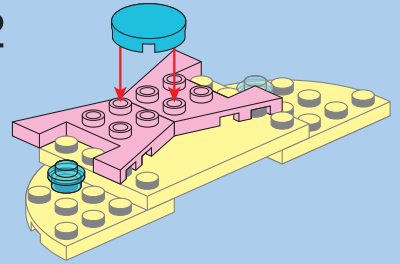

1

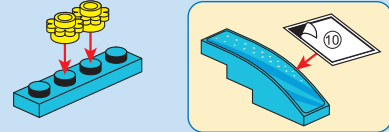

2

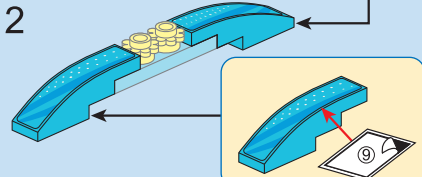

3

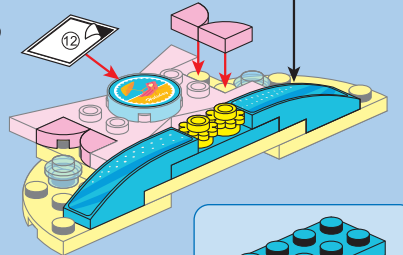

4

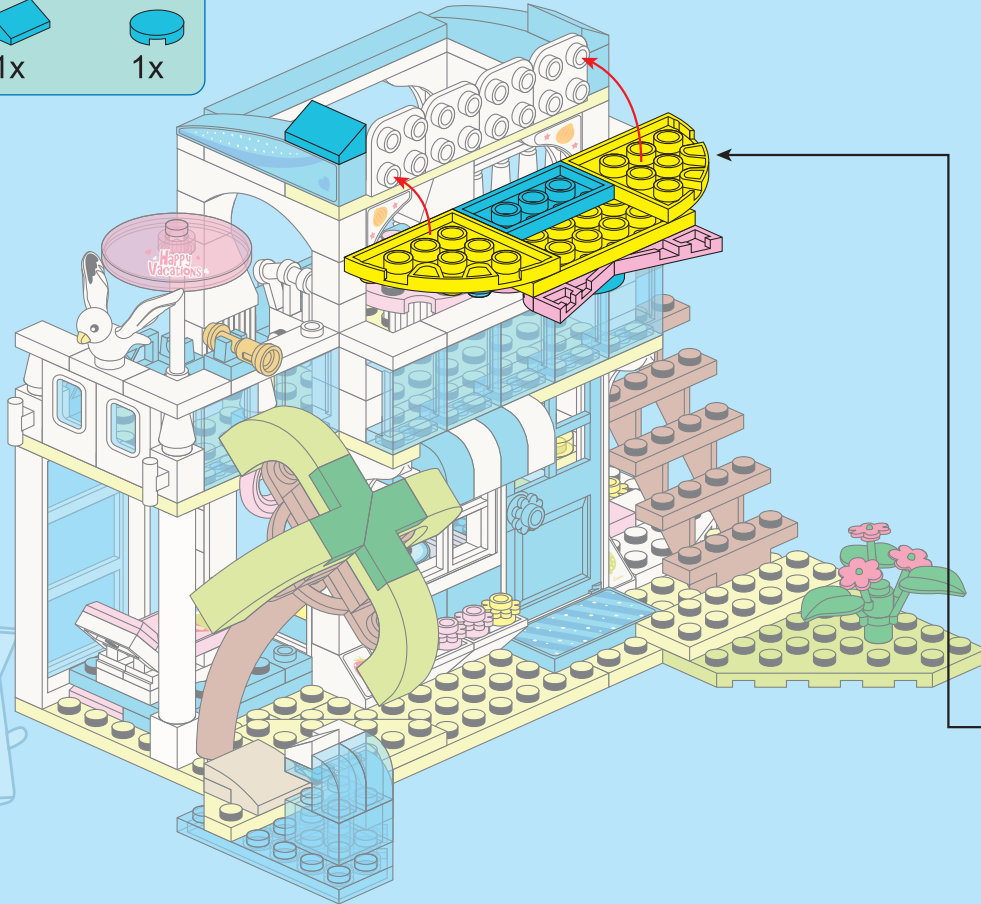
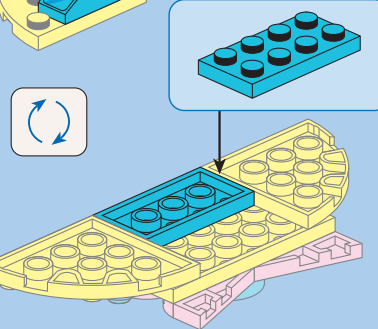

- 1x
- 1x
- 1x
- 1x
- 1x
- 1x
- 1x
- 1x
- 1x
- 1x
- 1x
- 1x
- 1x
- 1x
- 2x
- 2x
- 2x

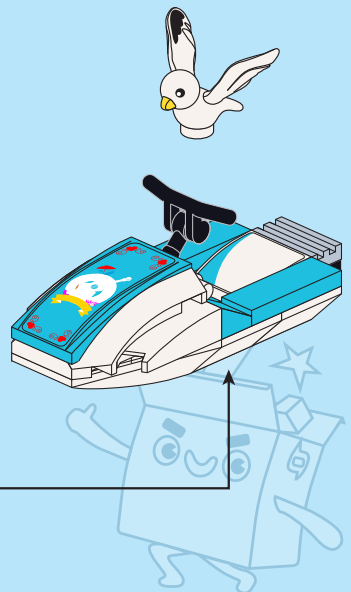
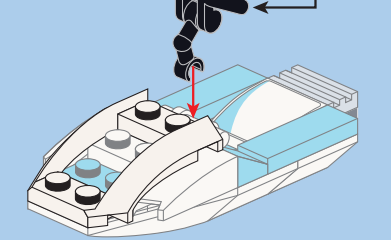
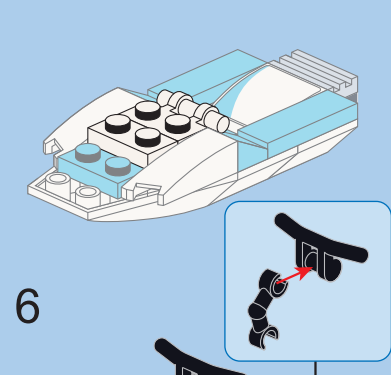
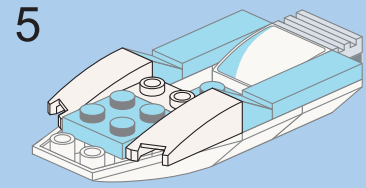
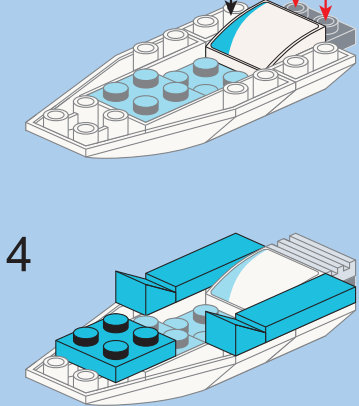
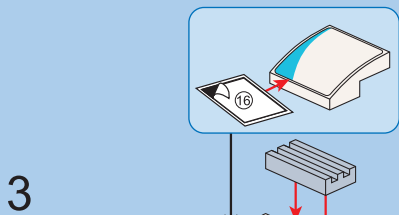
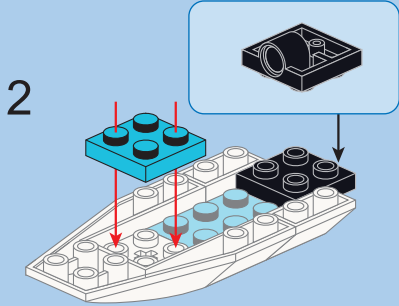
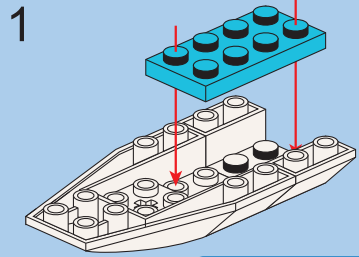

2

SECOND FORM

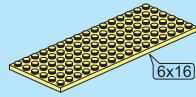

+

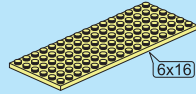

+



=

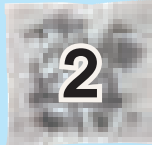

+

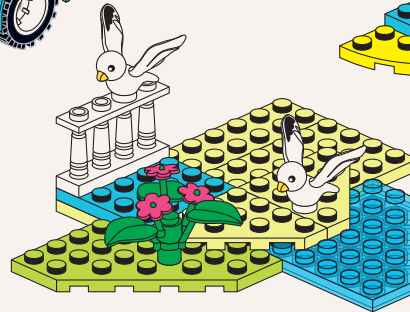
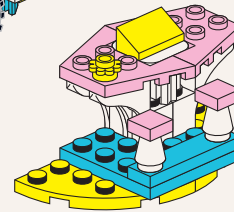
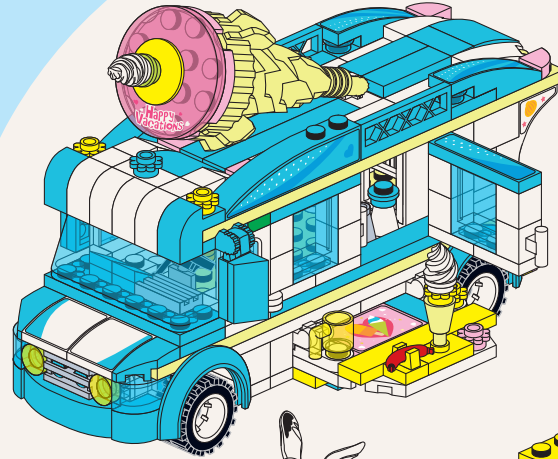
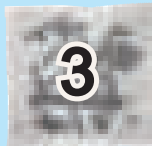

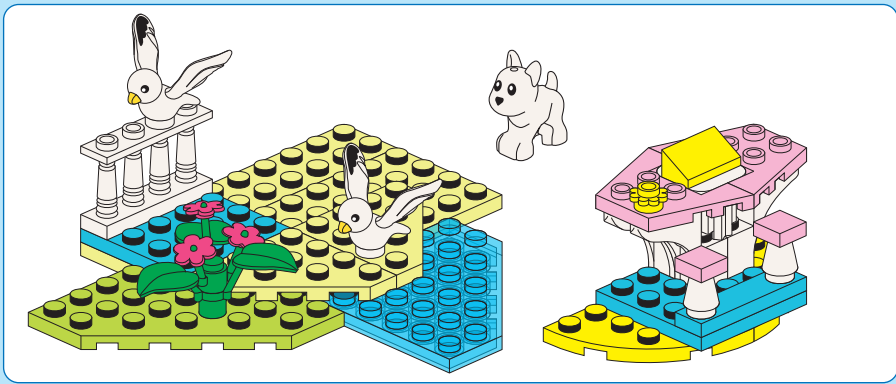

B1

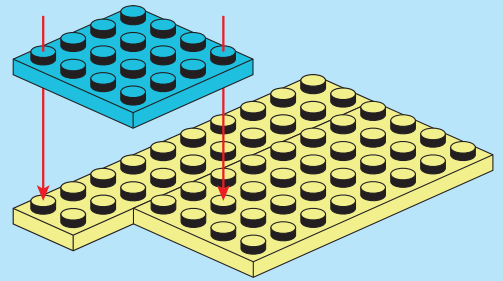
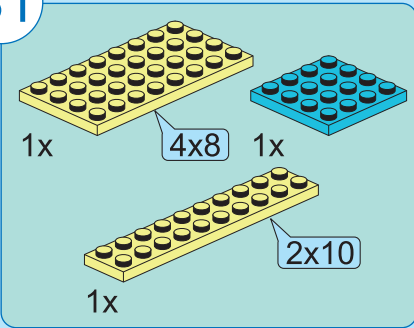

B2

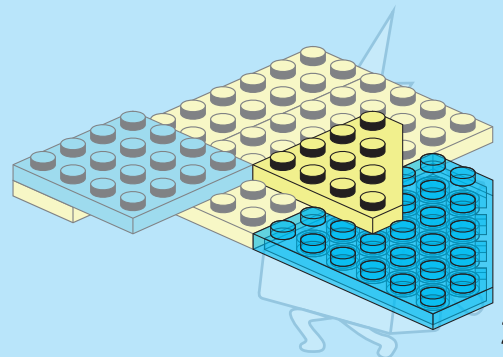
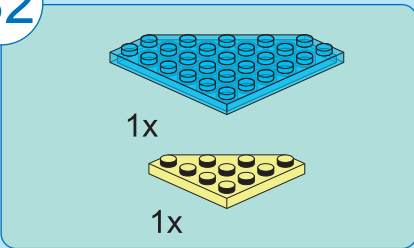

B3

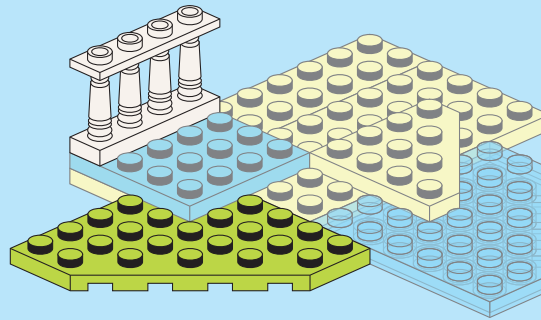
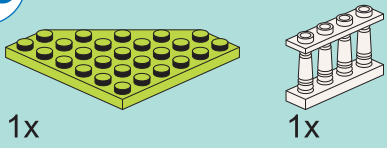

B4

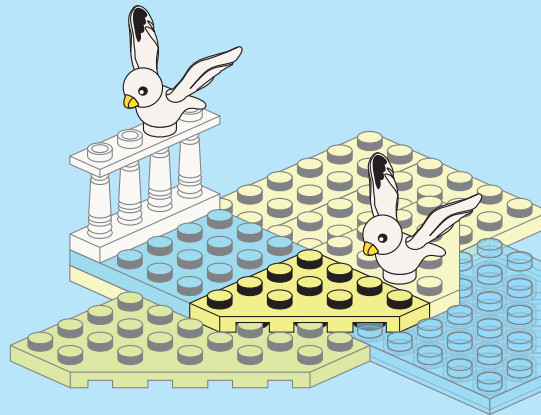
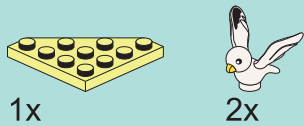

B5

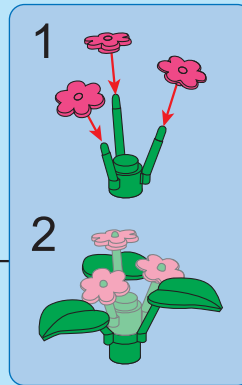
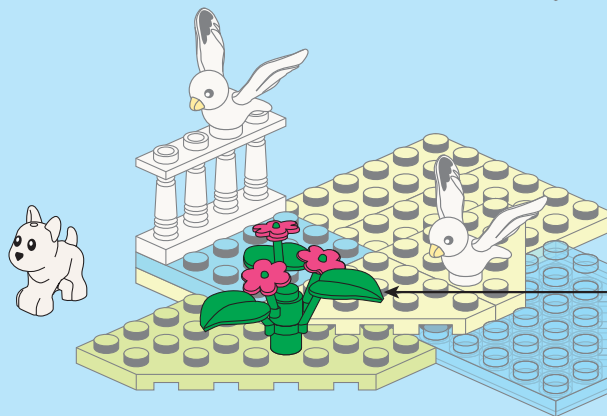
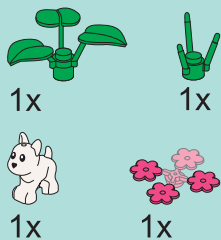

B6

- 1x (Blue 4x4 Technic Plate)
- 1x (Blue 1x3 Technic Beam)
- 2x (Yellow 4x4 Technic Plate)
- 1x (Yellow 1x2 Technic Beam)
- 1x (Yellow 1x2 Technic Pin)
- 4x (White 1x2 Technic Connector)
- 1x (White 1x2 Technic Pin)
- 1x (White 1x2 Technic Pin)
- 2x (Pink 1x3 Technic Plate)
- 2x (Pink 1x2 Technic Plate)
- 2x (White 1x2 Technic Pin)

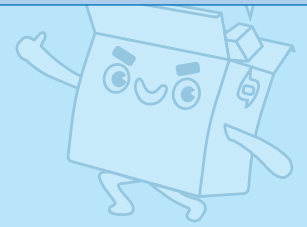
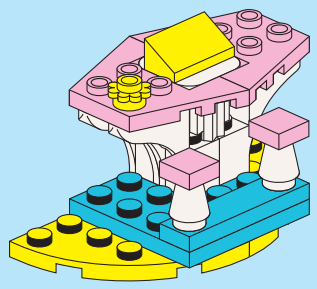
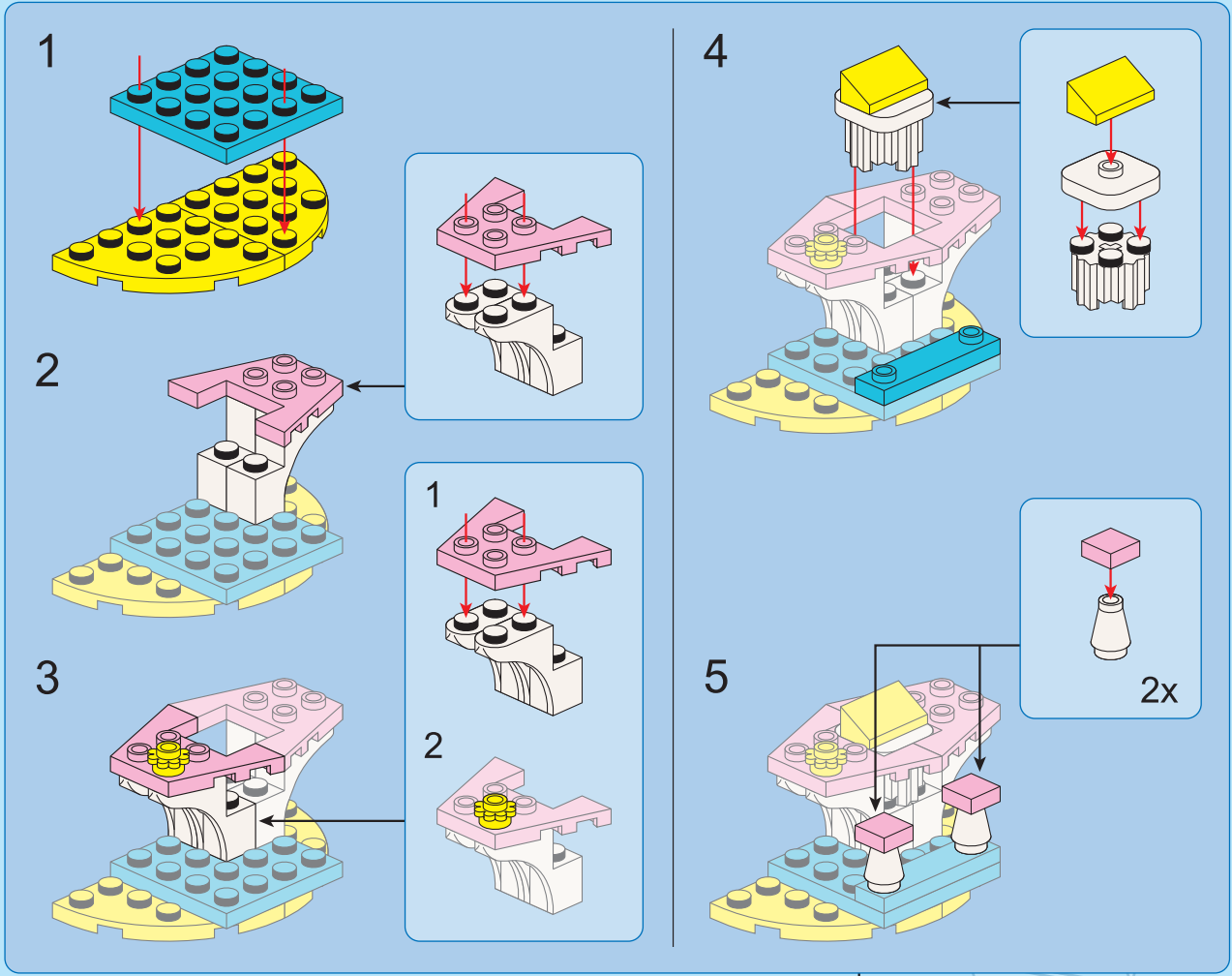

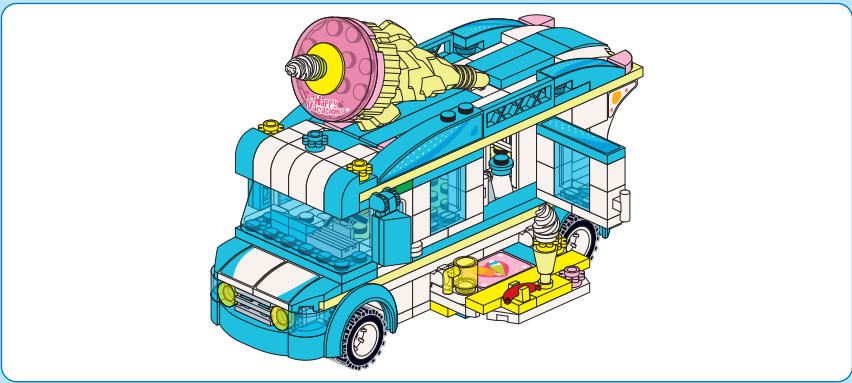

C1

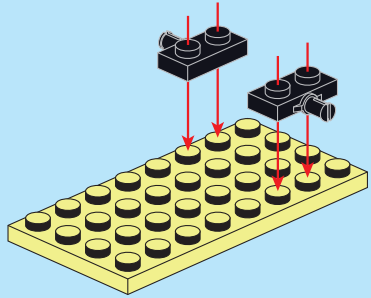
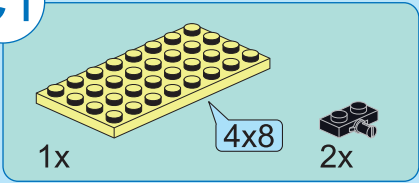

C2

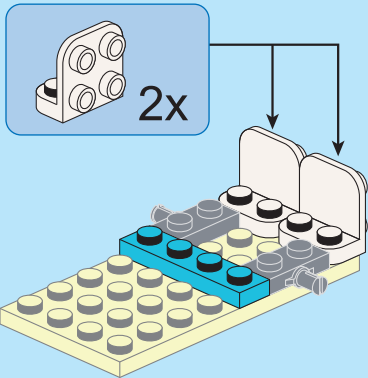
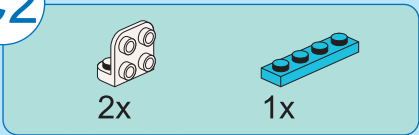

C3

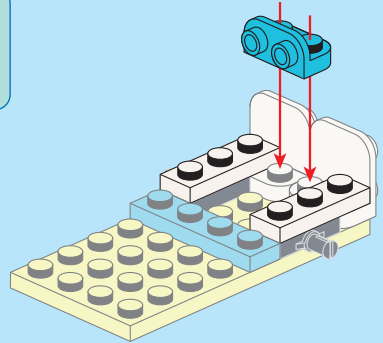
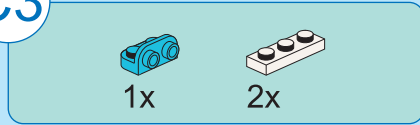

C4

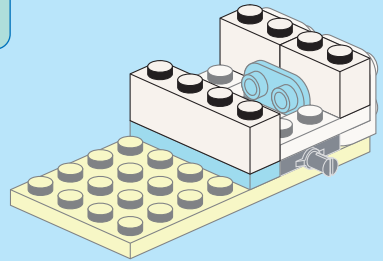
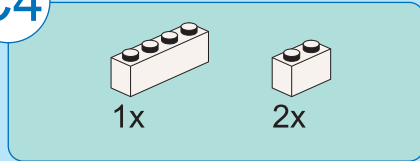

C5

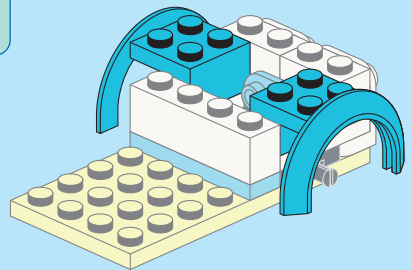
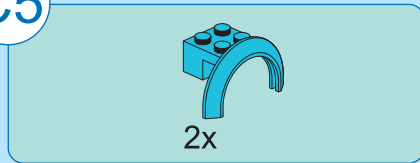

C6

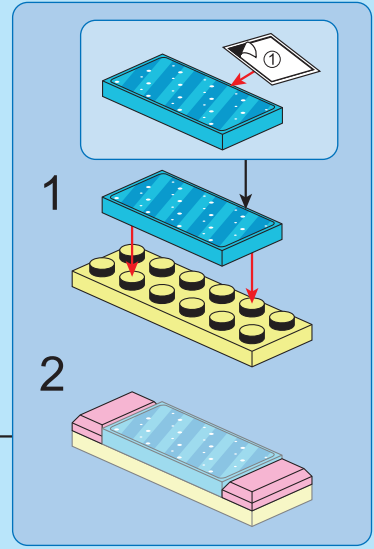
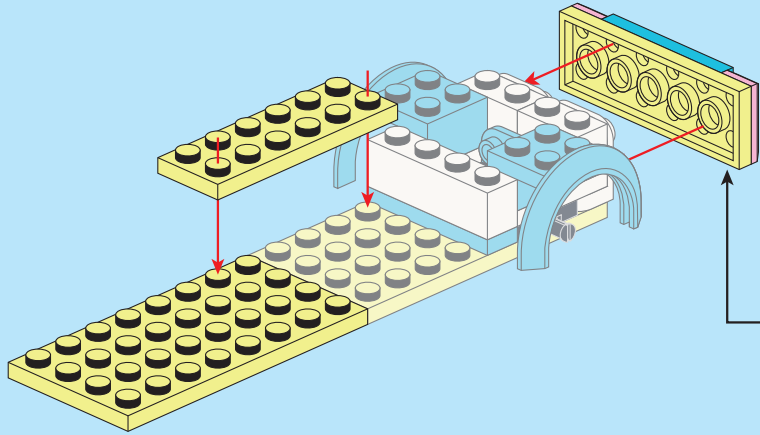
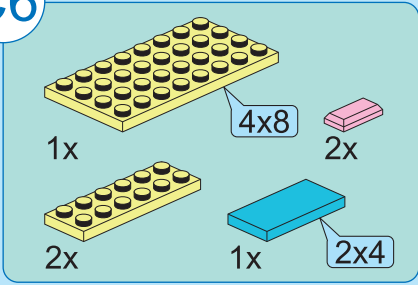

C7

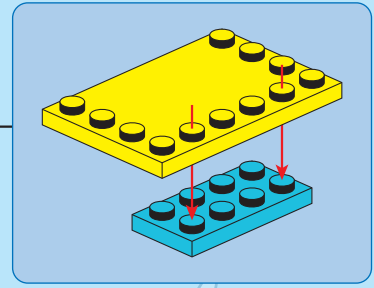
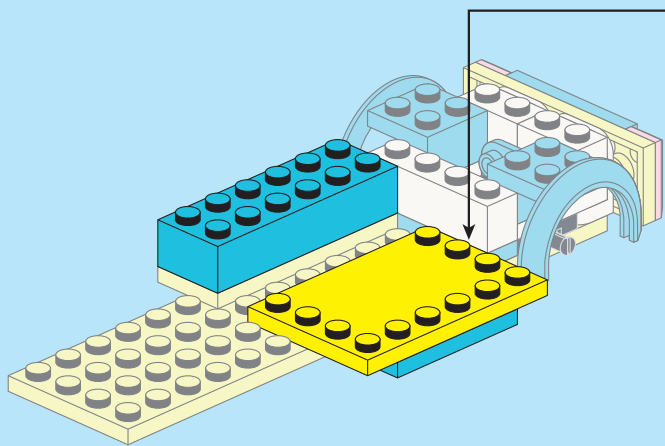
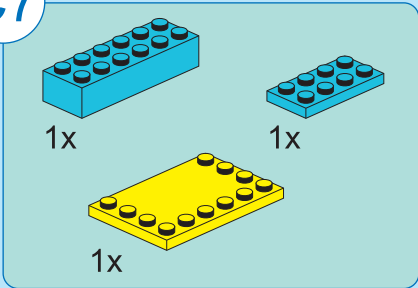

C8

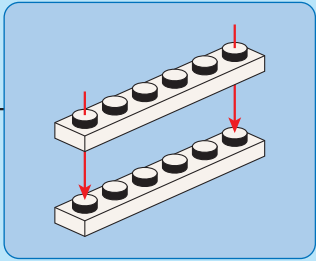
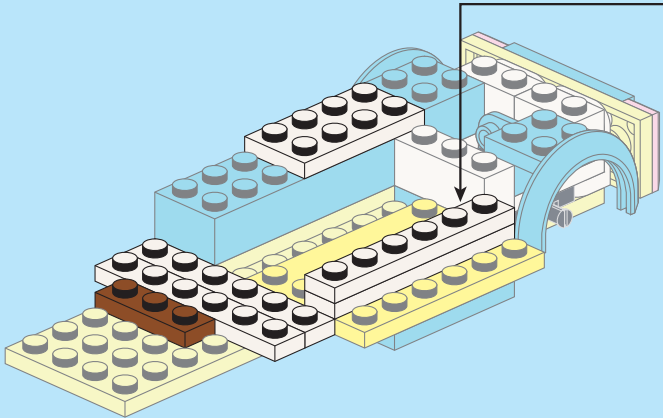
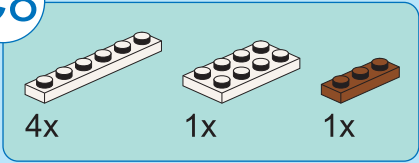

C9

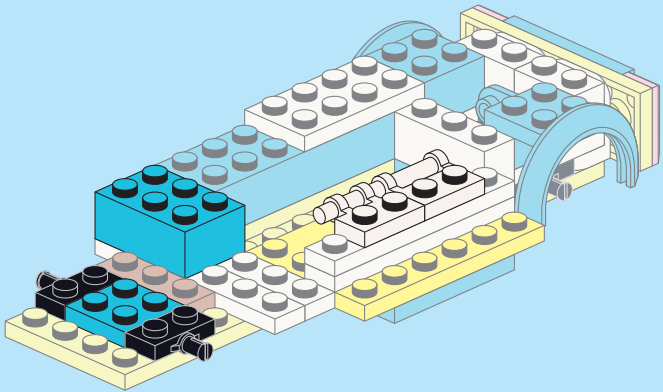
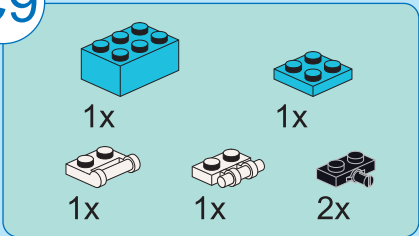

C10

- 1x
- 1x
- 2x
- 1x
- 1x
- 1x
- 1x
- 1x
- 1x
- 1x
- 1x
- 1x
- 1x
- 1x

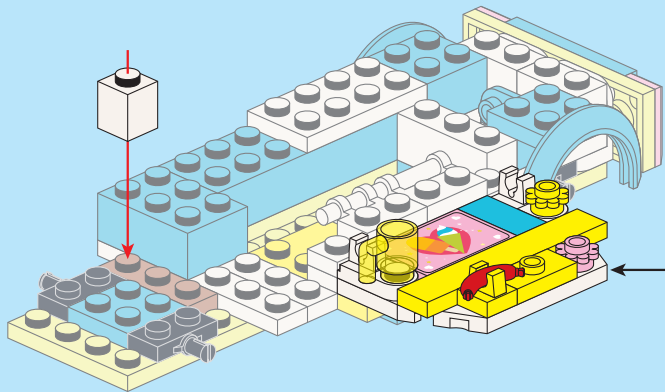

- 1
- 2
- 3
- 4

C11

- 1x
- 1x
- 1x
- 1x
- 1x
- 1x
- 2x

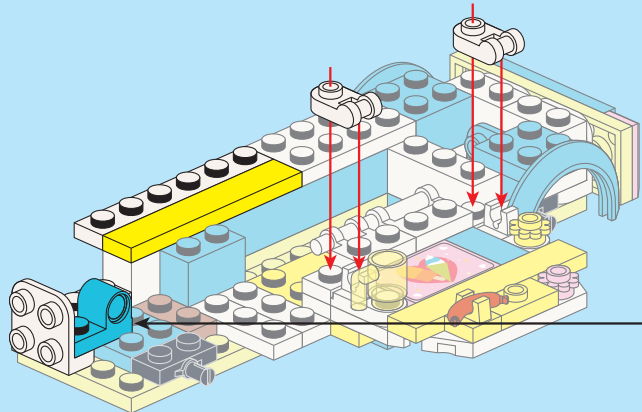

- 1
- 2

C12

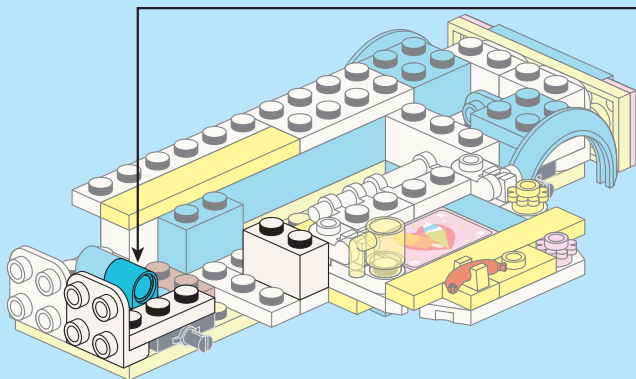
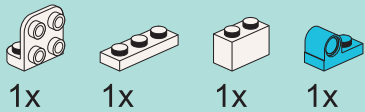

1

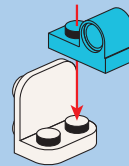

2

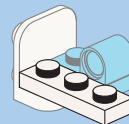

C13

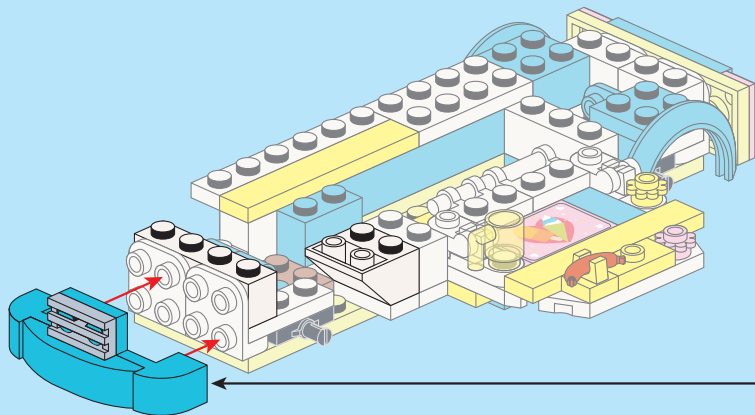
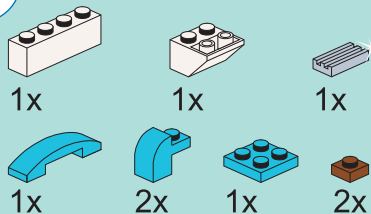

1

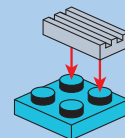

2

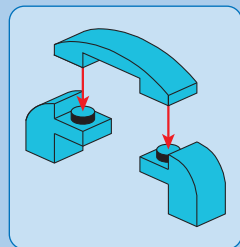
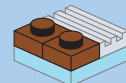

3

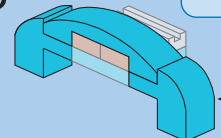

C14

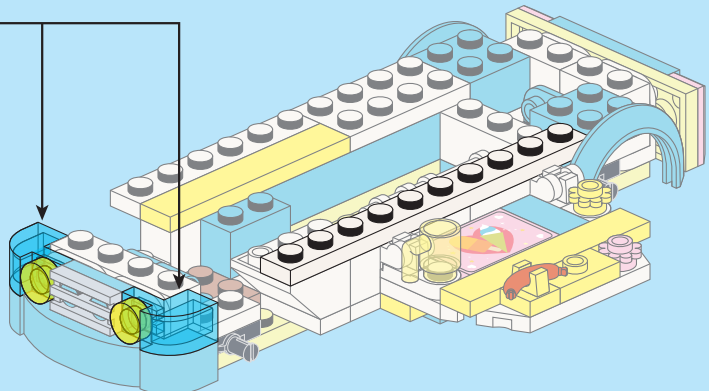
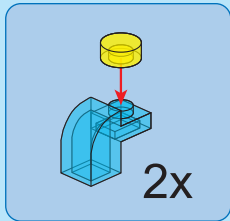
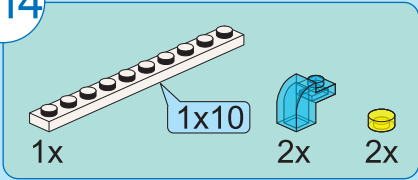

C15

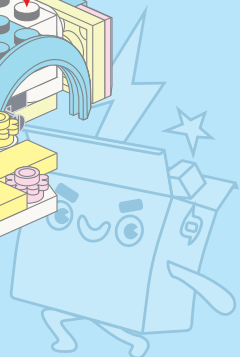
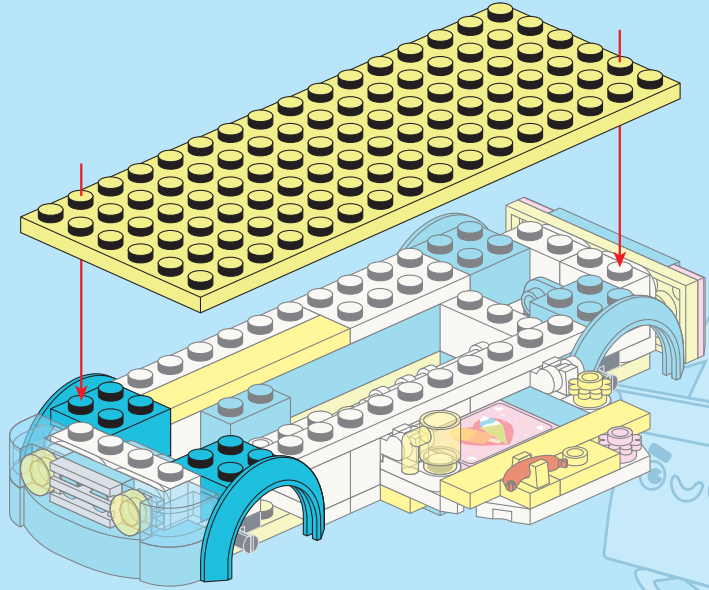
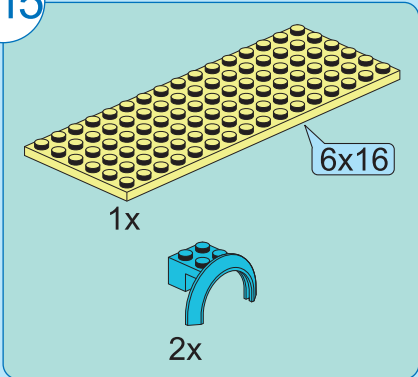

C16

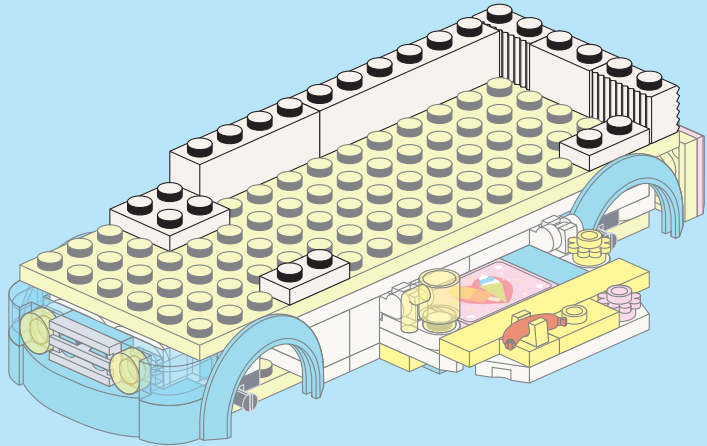
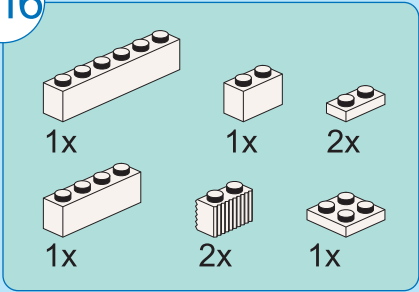

C17

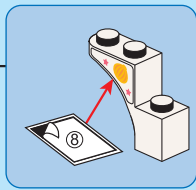
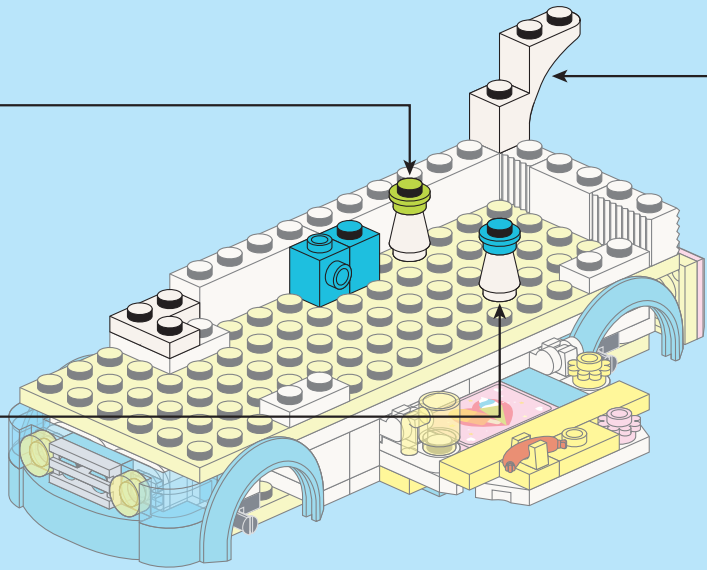
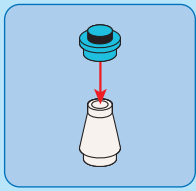
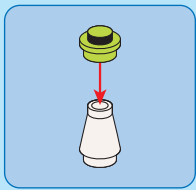
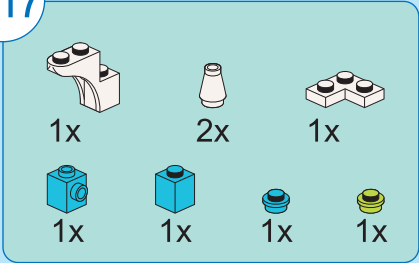

C18

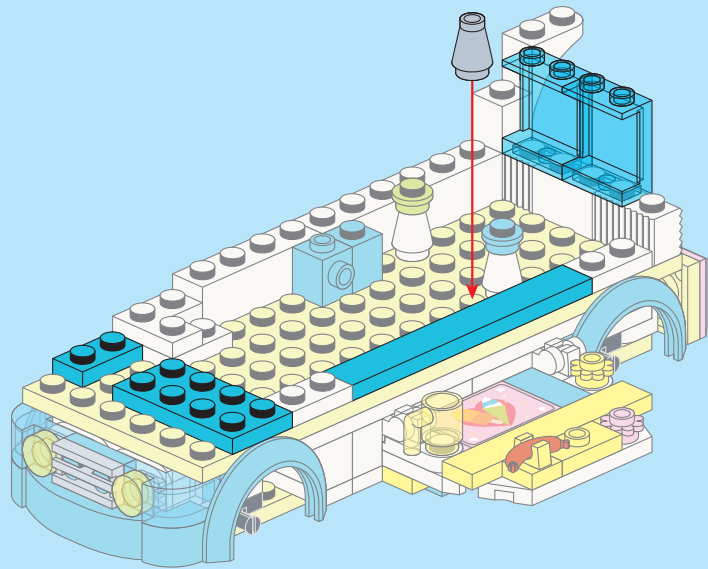
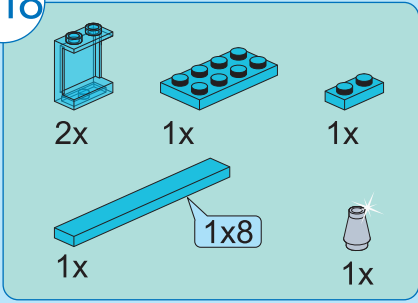

C19

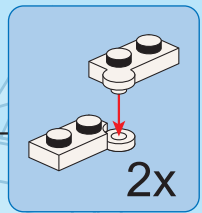
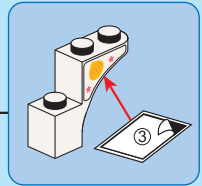
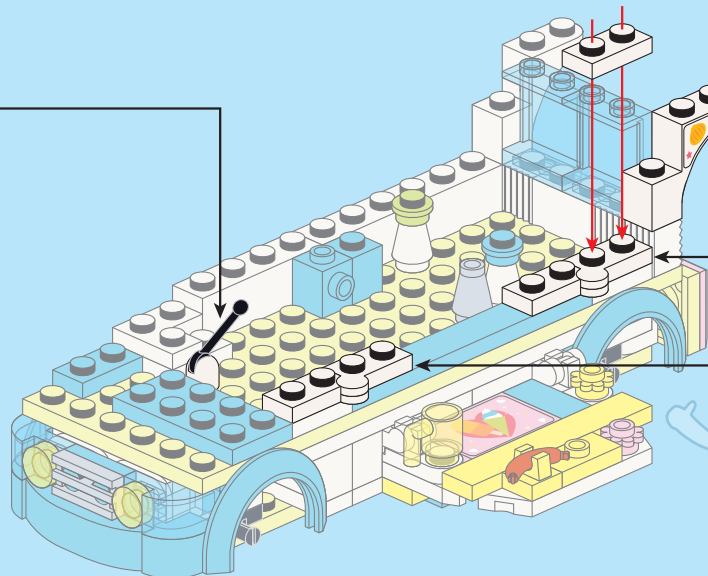
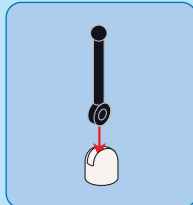
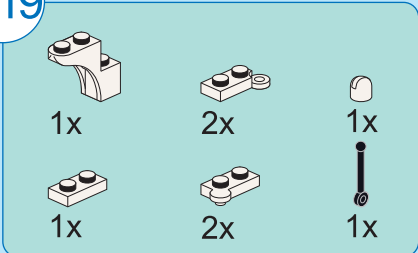

C20

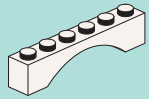

2x



1x



2x



1x

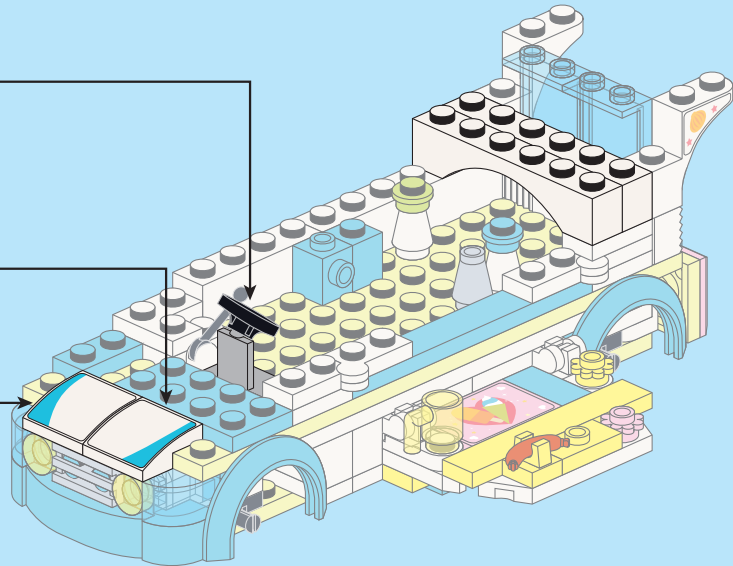
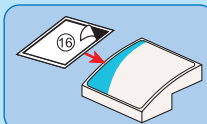
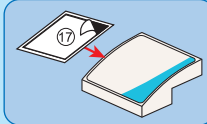
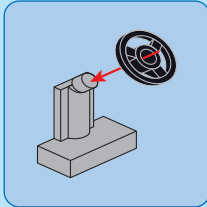

C21



2x



2x



1x



1x



1x

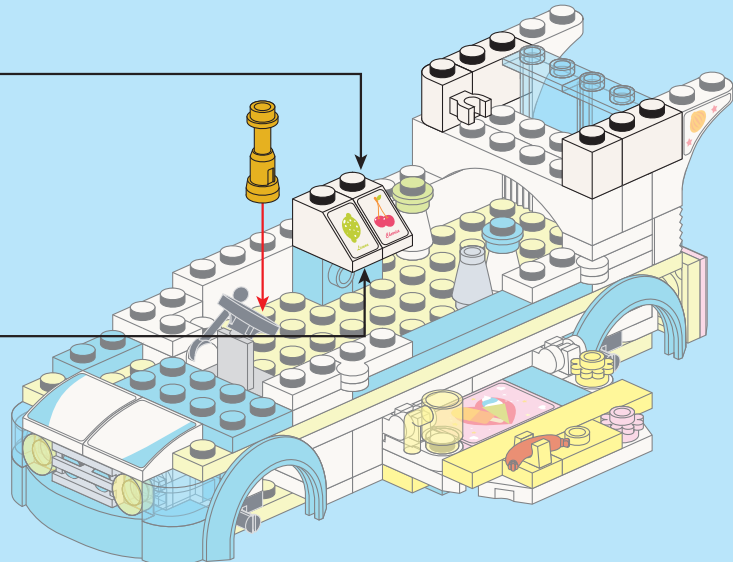
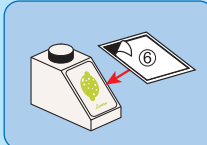
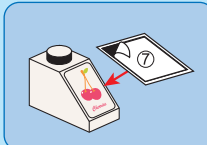

C22

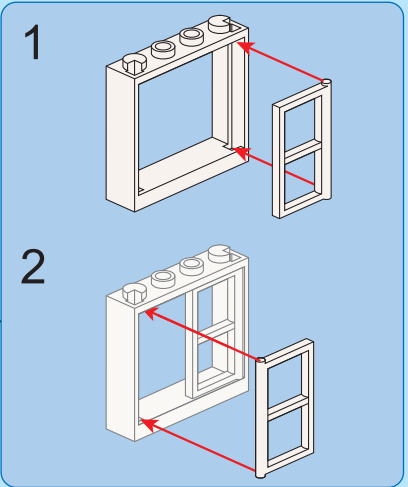
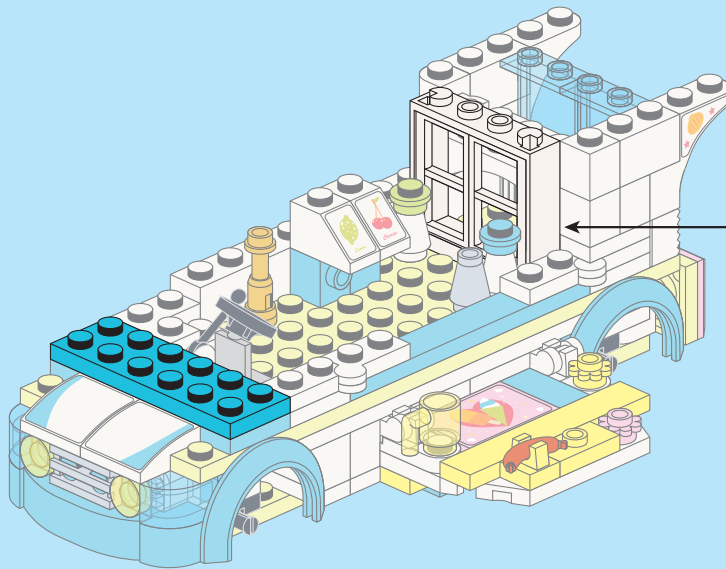
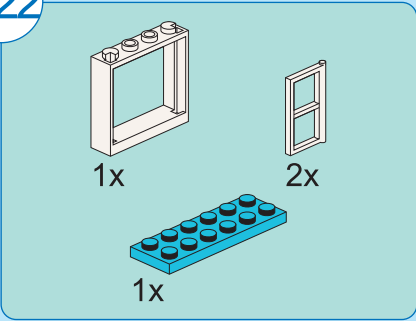

C23

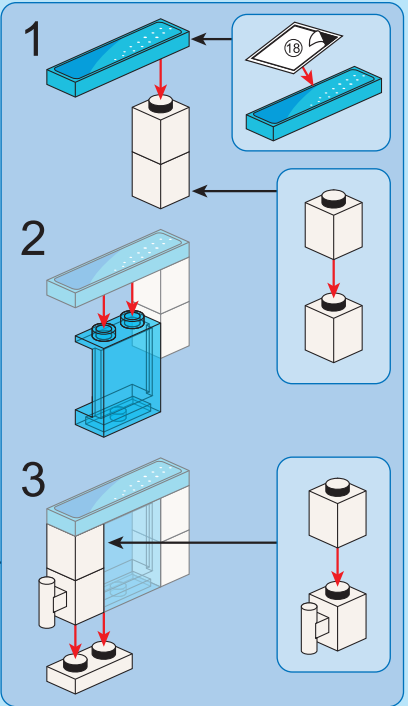
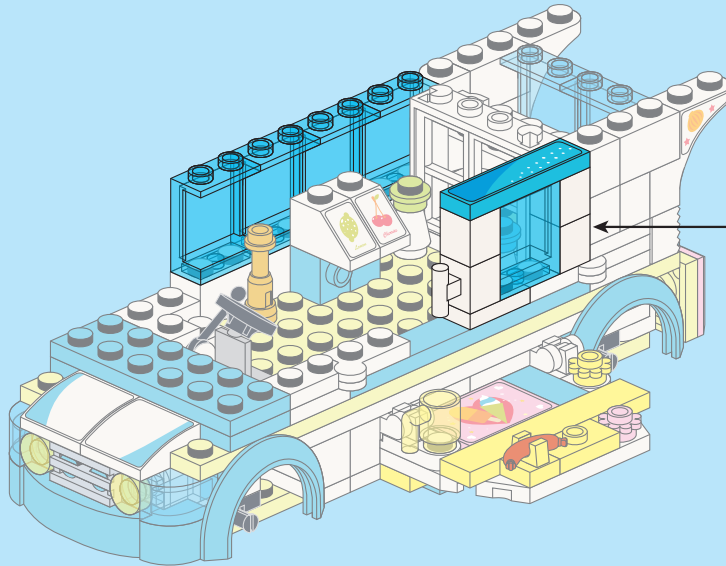
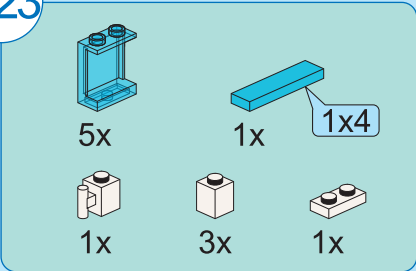



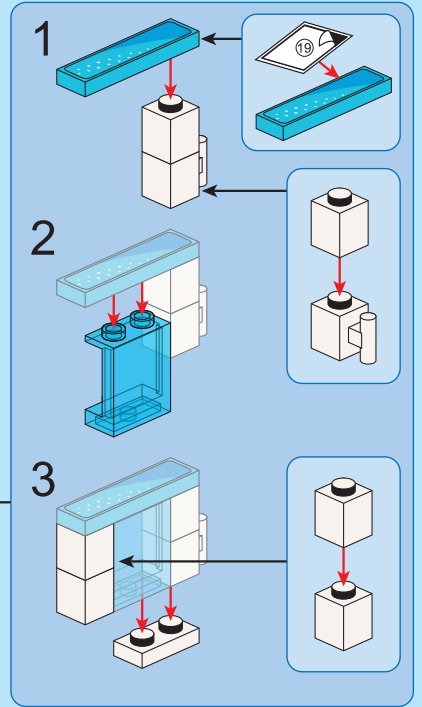
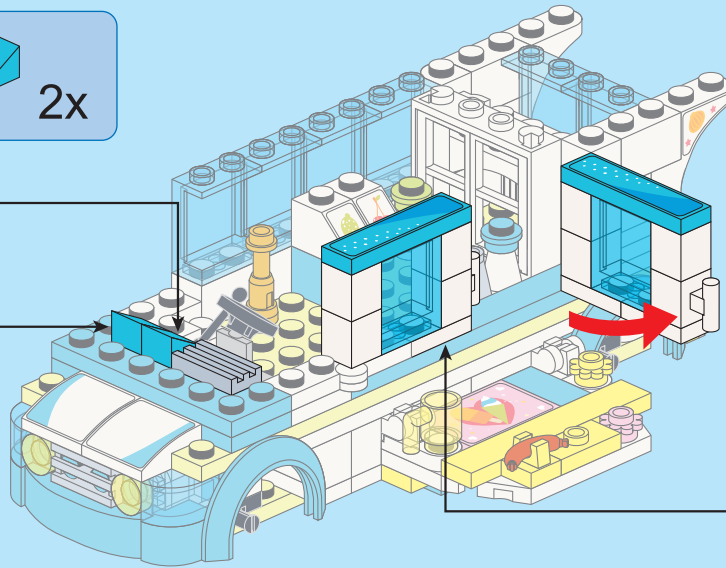
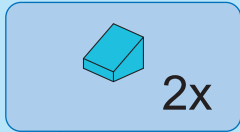
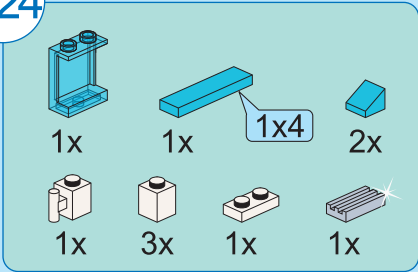

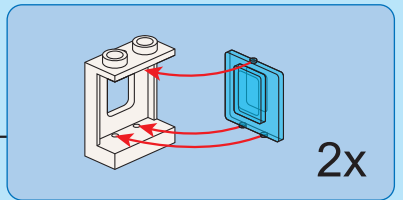
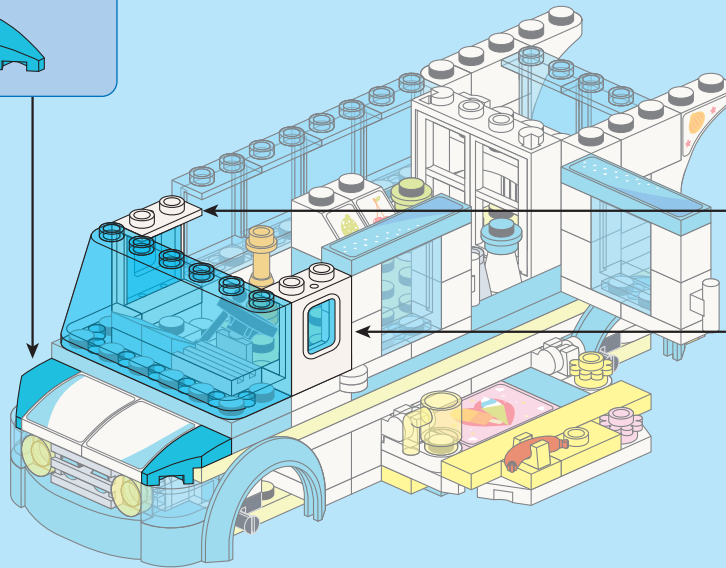
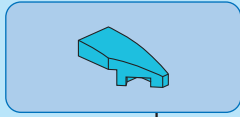
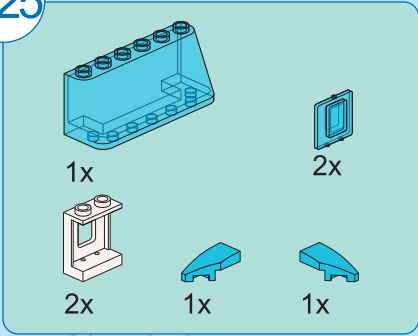

C24

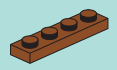

C25



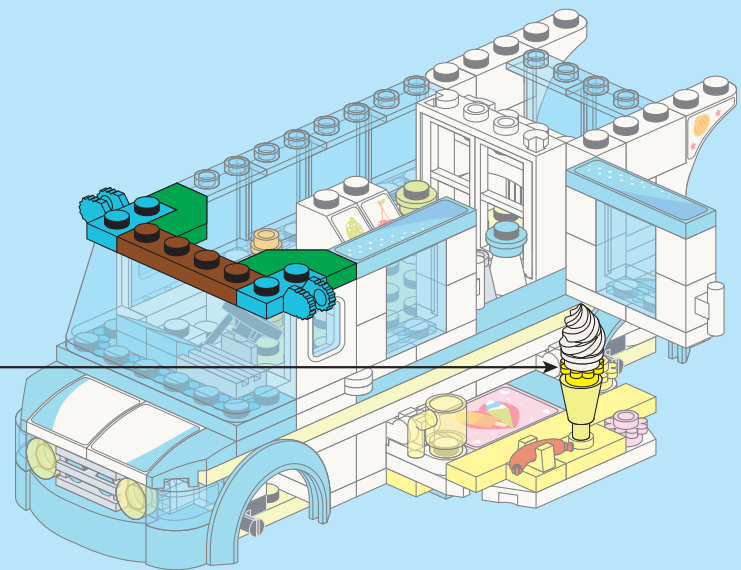
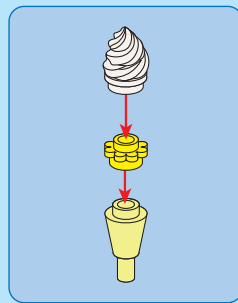

C26

- 1x 
- 2x 
- 1x 
- 2x 
- 1x 
- 1x 

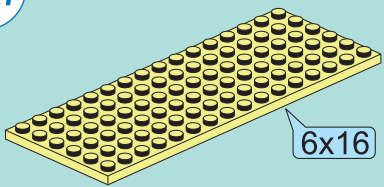

C27

- 1x  6x16
- 2x 
- 2x 

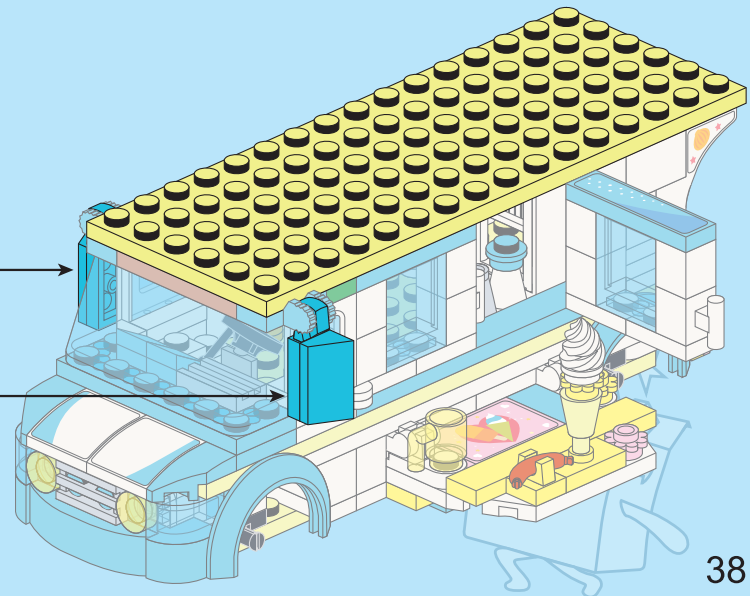
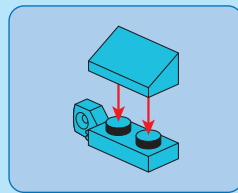
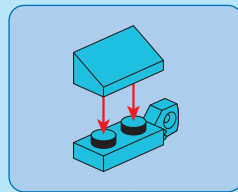

C28

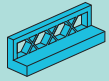

1x



1x



1x



2x

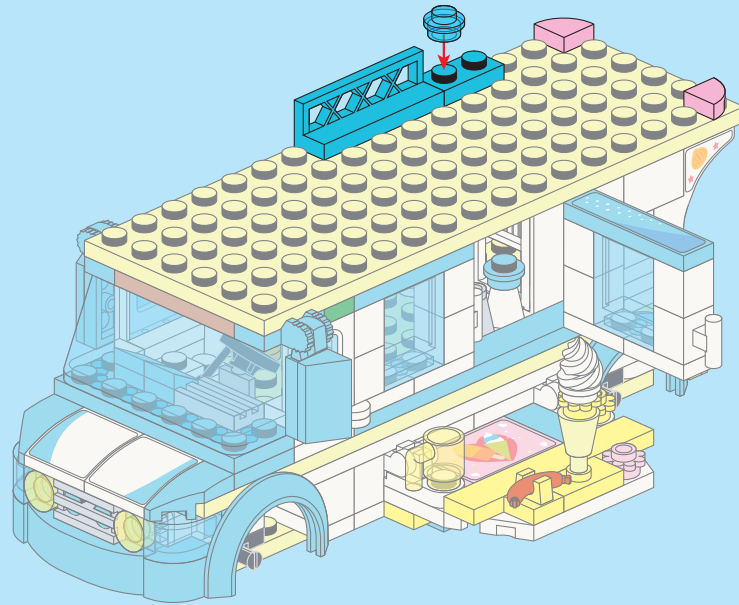

C29

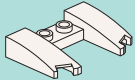

1x



1x

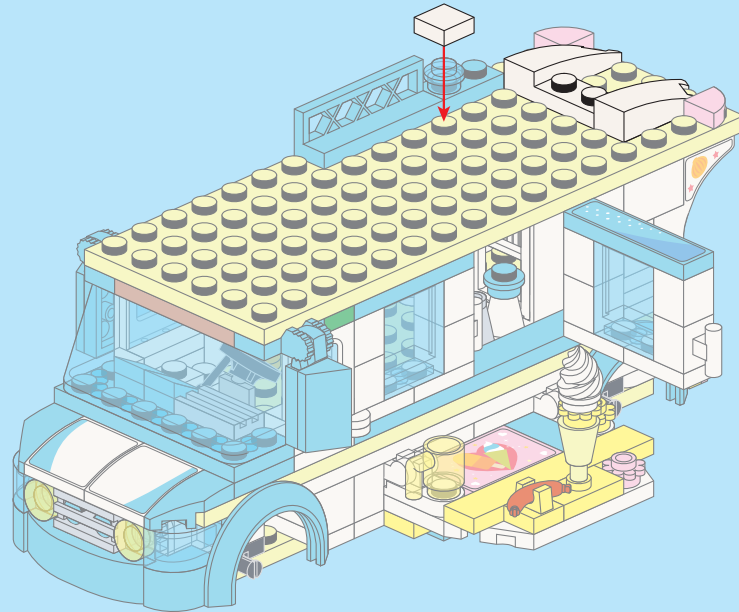

C30



2x



1x



1x

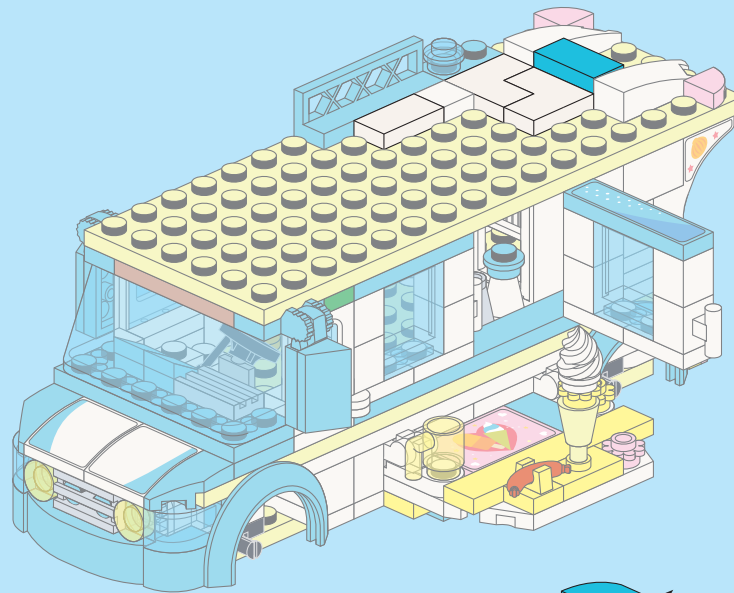

C31



1x

1x4



1x



1x

1x3



1x

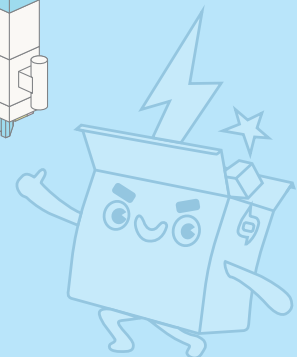
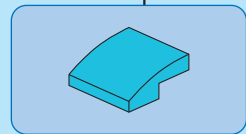
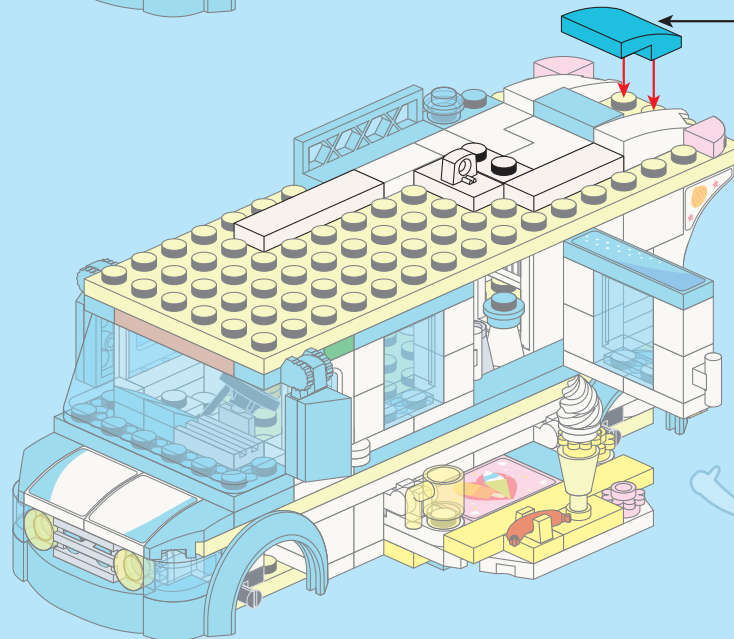

C32

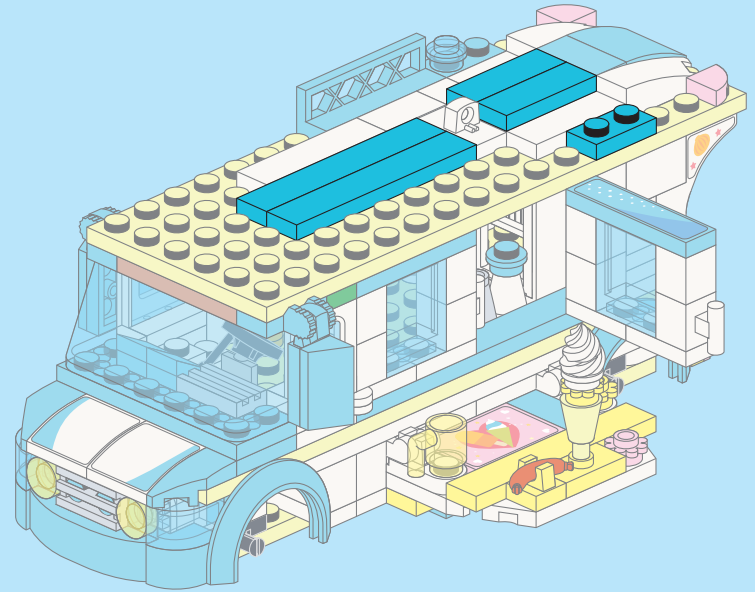
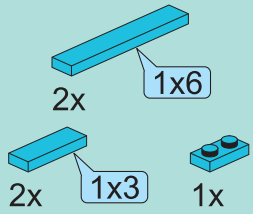

C33

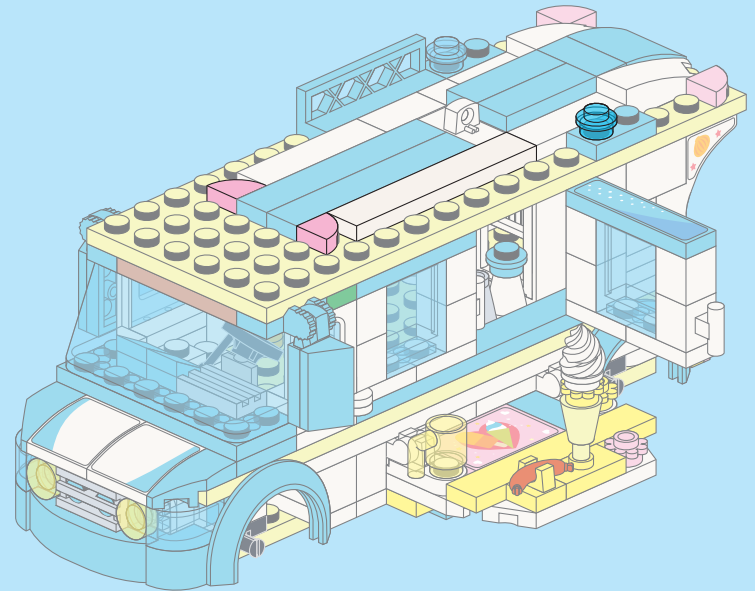
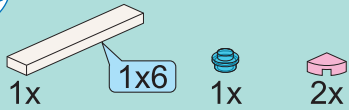

C34

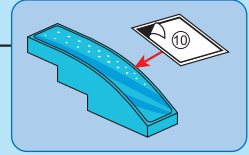
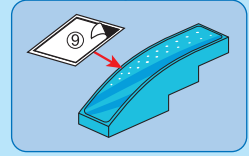
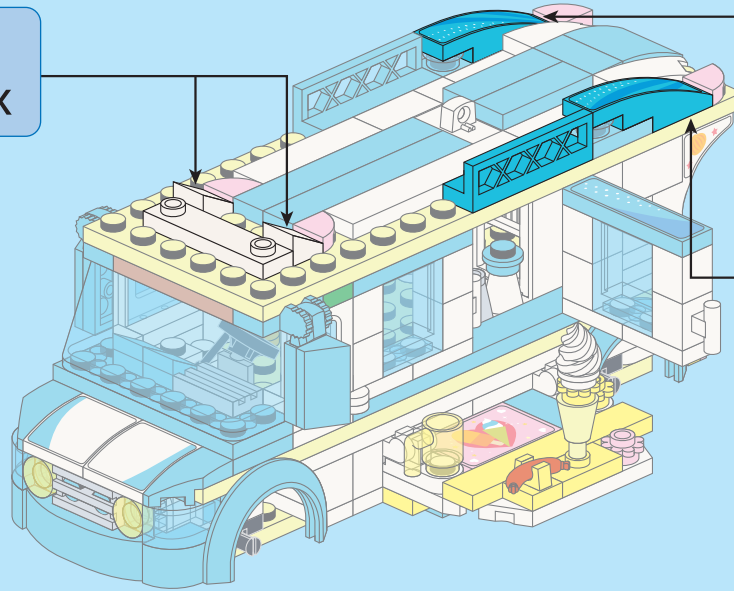
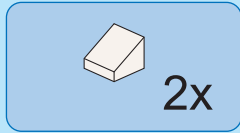
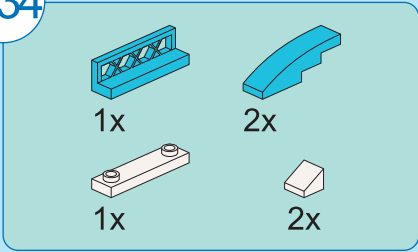

C35

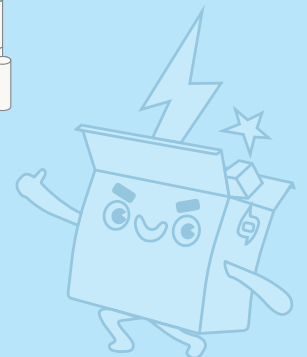
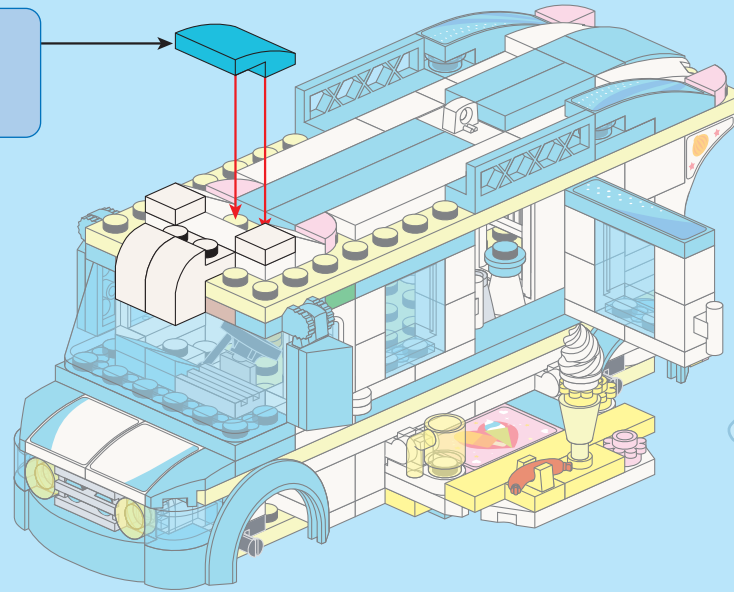
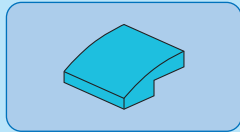
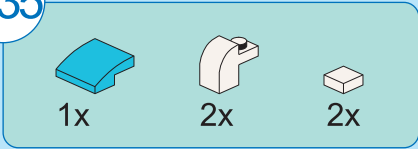

C36

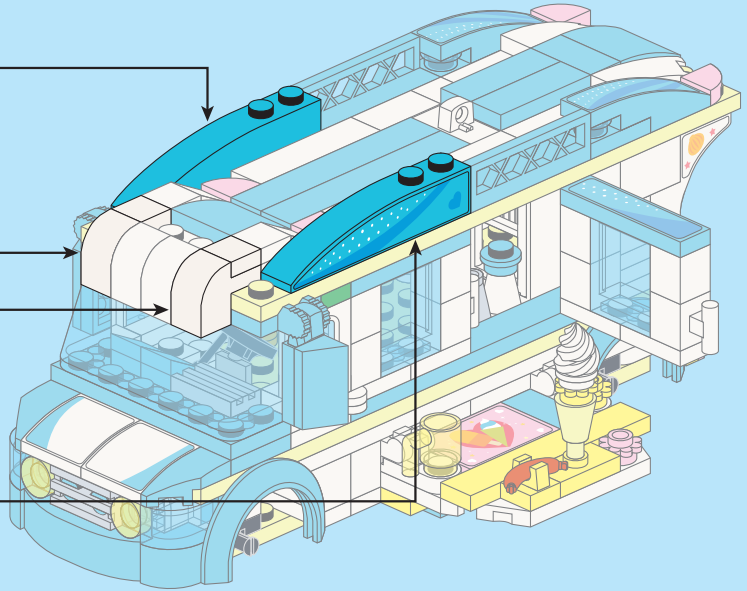
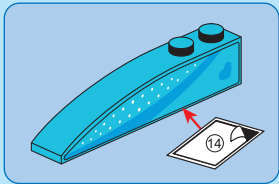
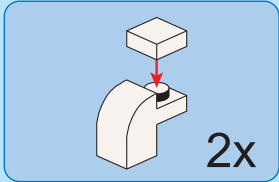
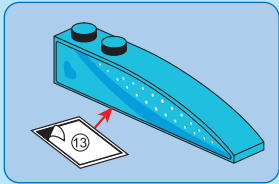
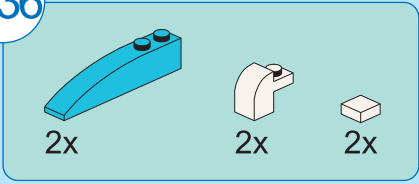

C37

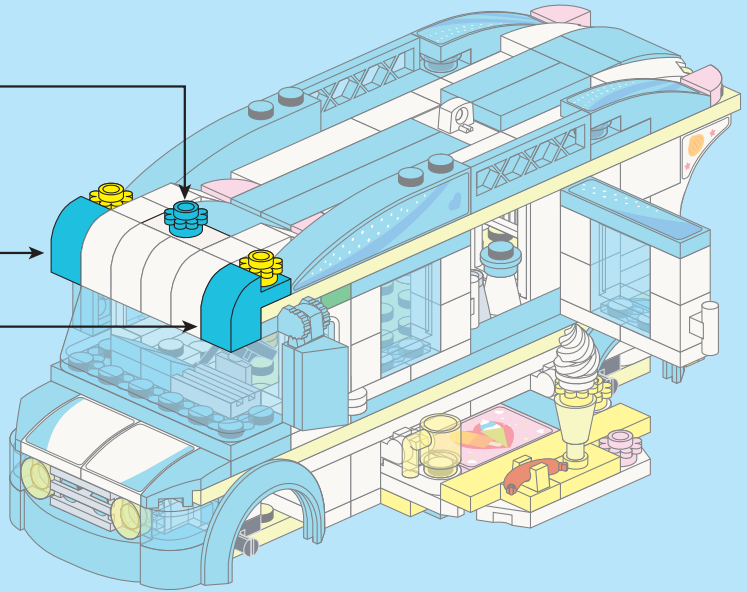
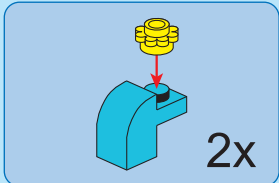
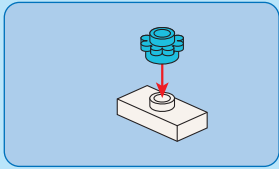
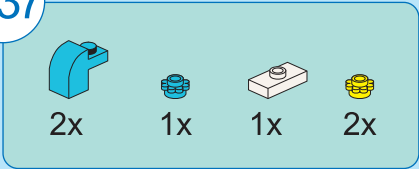

C38

- 1x
- 1x
- 1x
- 1x
- 1x
- 1x
- 1x
- 1x
- 1x

8 1:1

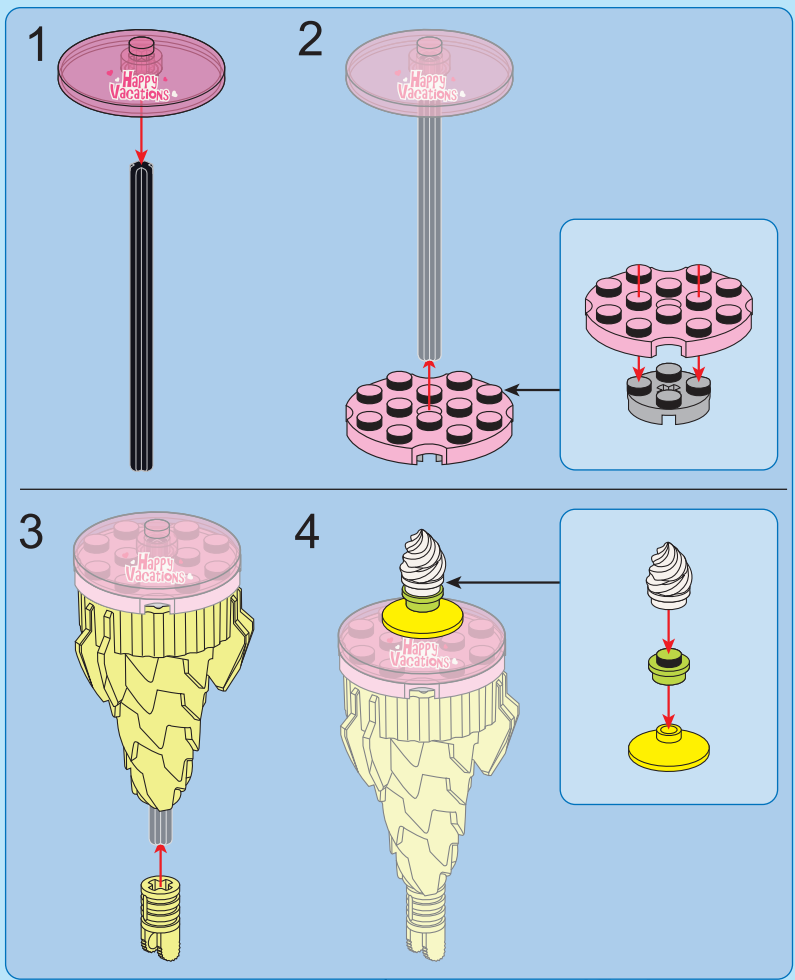
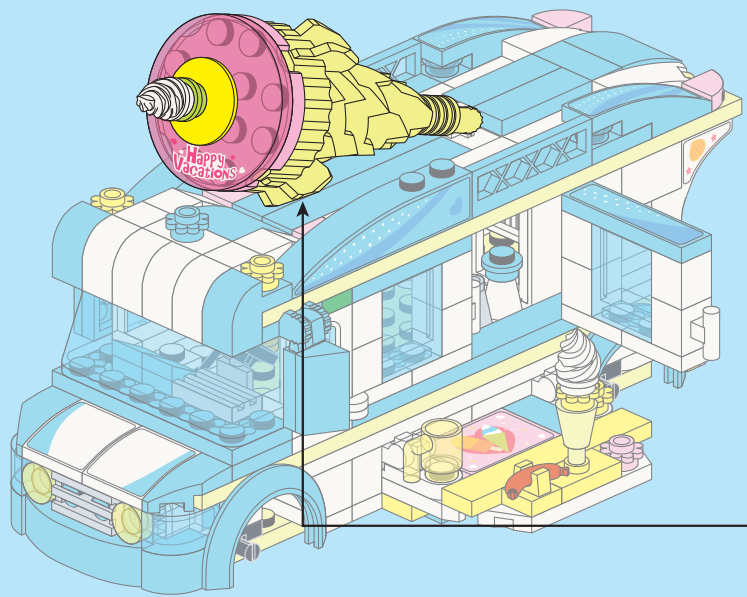

C39



4x



4x

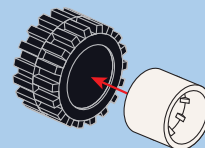
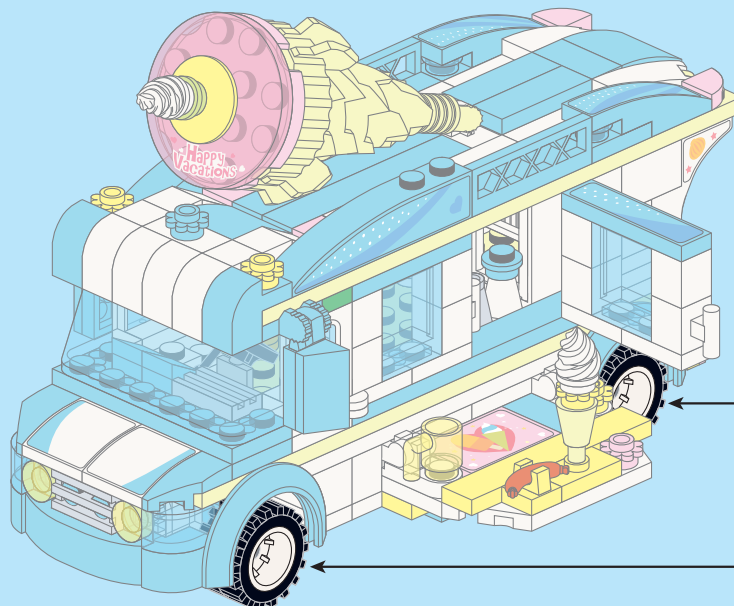

4x



3

THIRD FORM

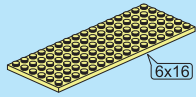

+

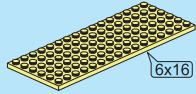

+



=

+



+

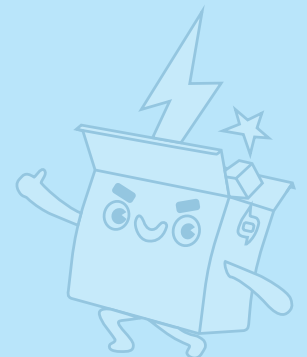
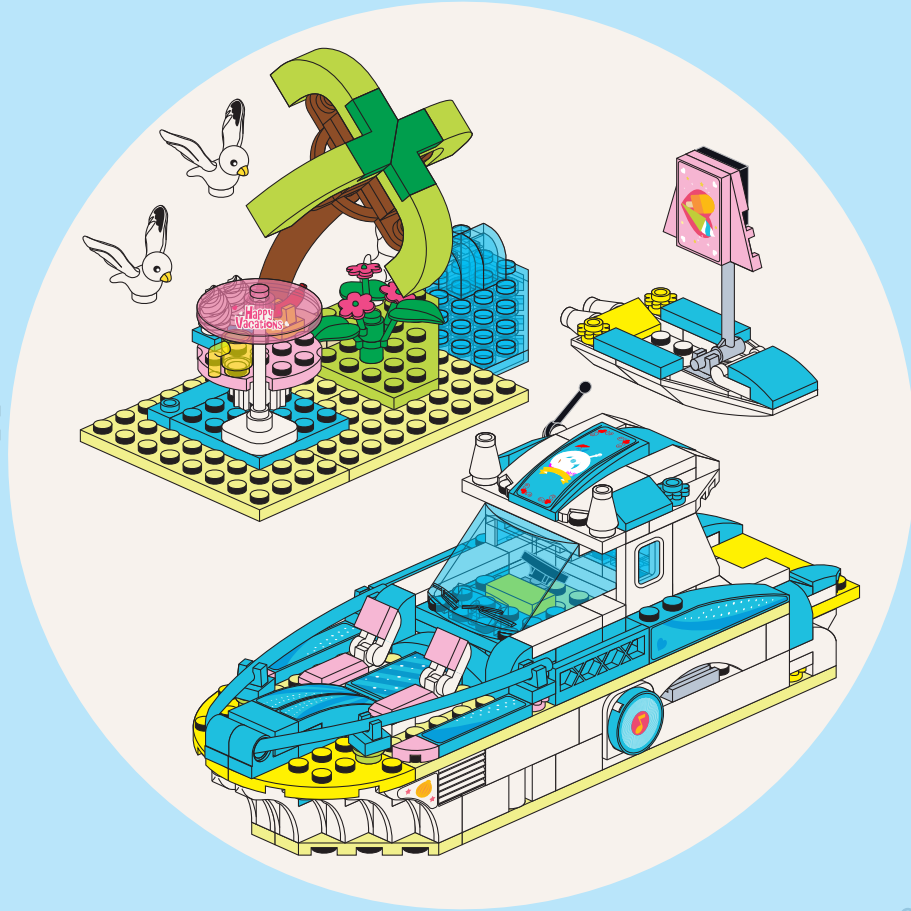
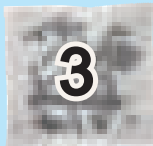

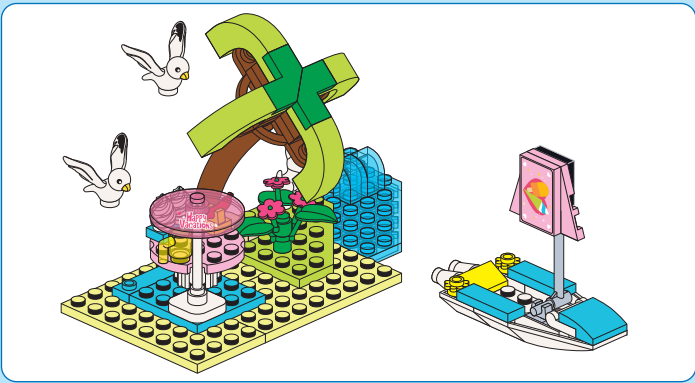

D1

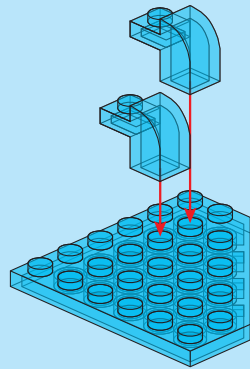
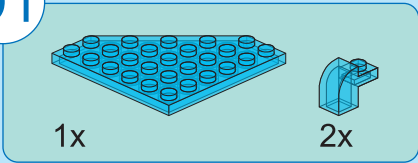

D2

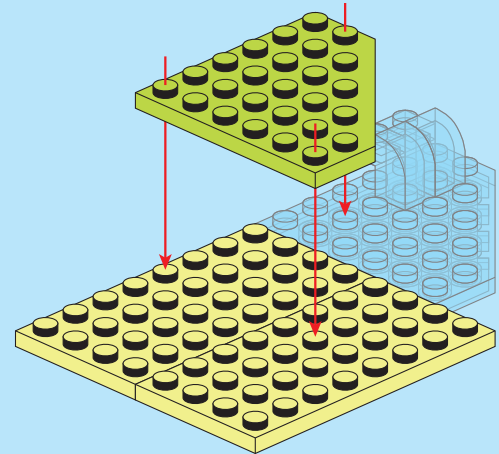
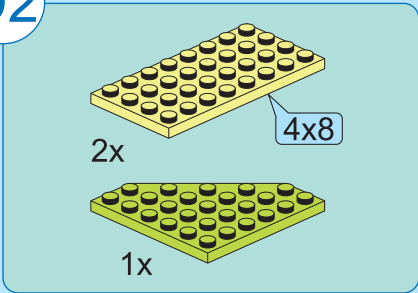

D3

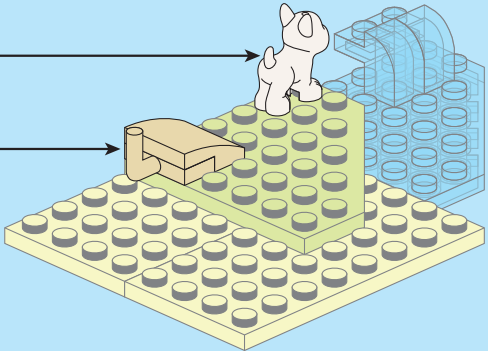
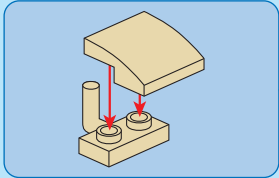
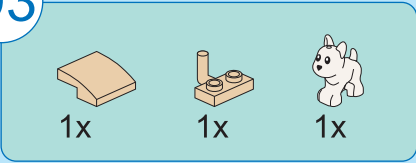

D4

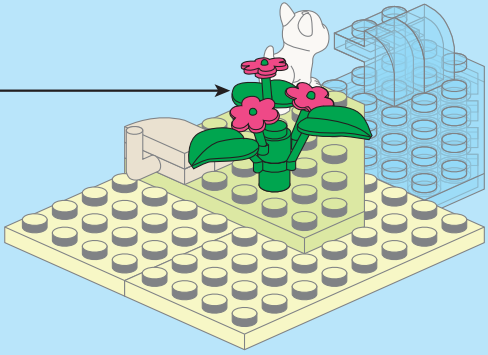
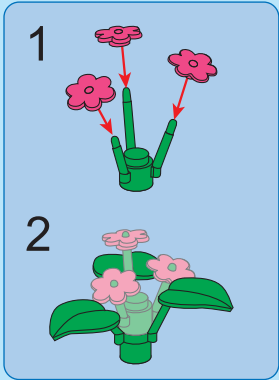
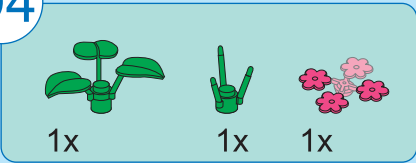

D5

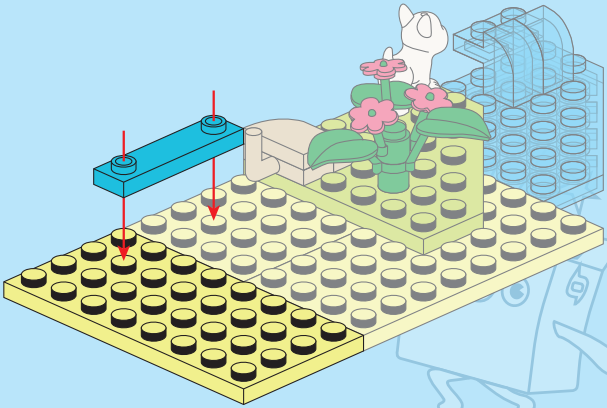
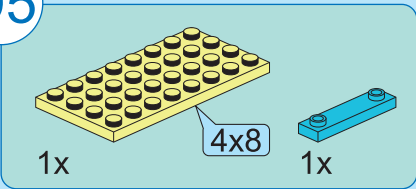

D6



1x



1x

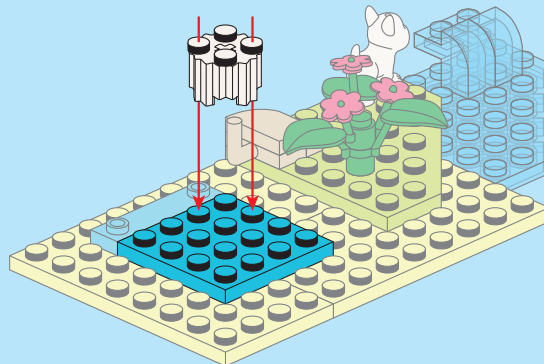

D7



1x



1x



D8



1x



1x



2x



1x



1x



1x

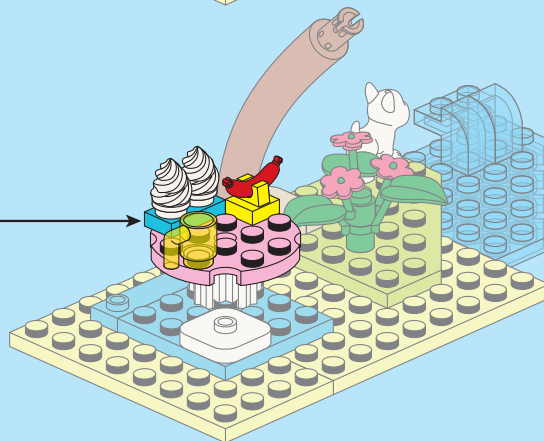
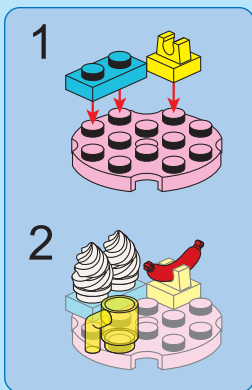

D9

- 1x
- 2x
- 4x
- 4x
- 1x
- 2x
- 1x
- 2x

1

2

3

4

5

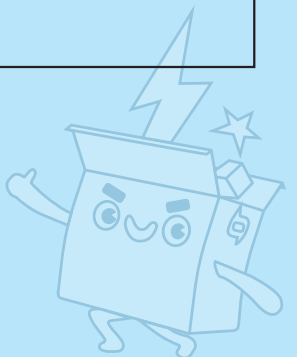
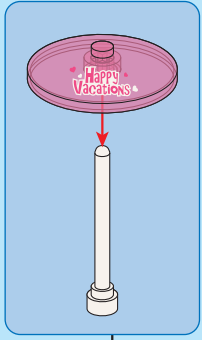
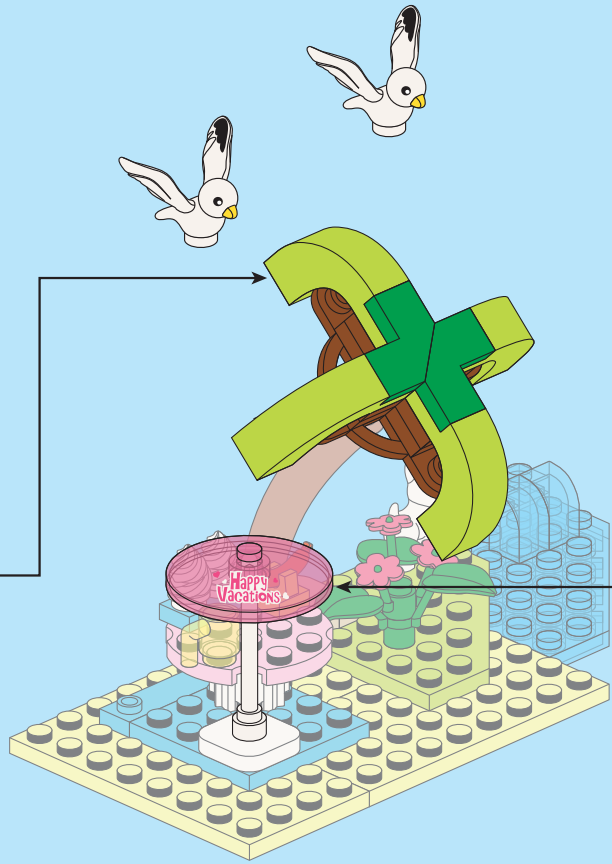

- 1x
- 1x
- 1x
- 1x
- 1x
- 1x
- 2x
- 1x
- 1x
- 3x
- 1x
- 2x
- 1x
- 1x
- 1x
- 1x
- 2x
- 1x
- 1x

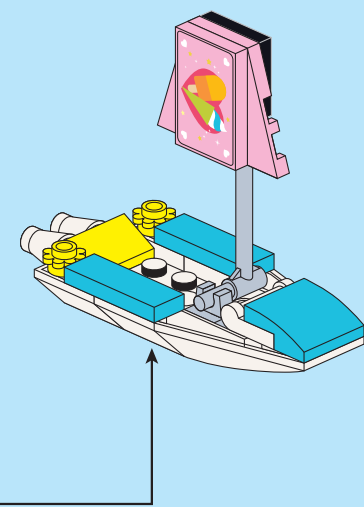
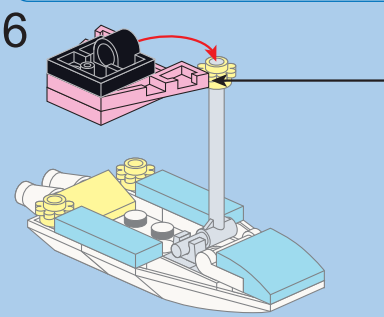
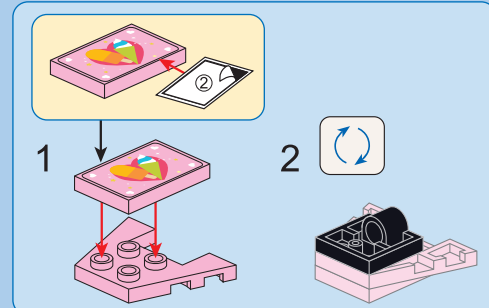
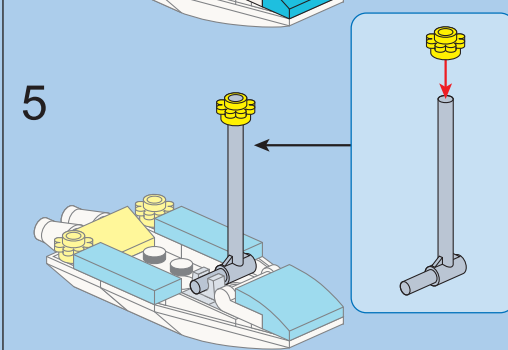
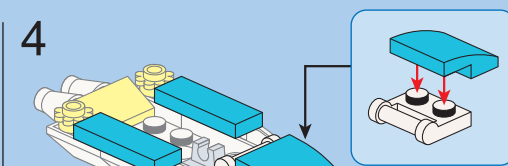
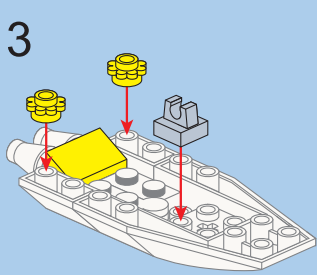
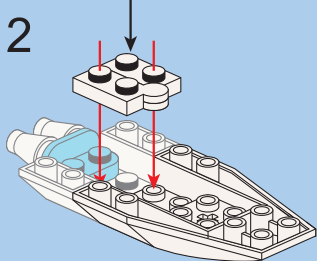
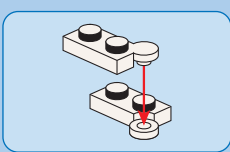
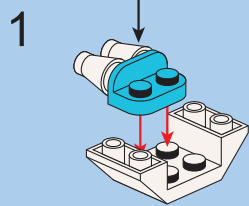
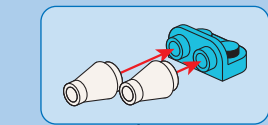

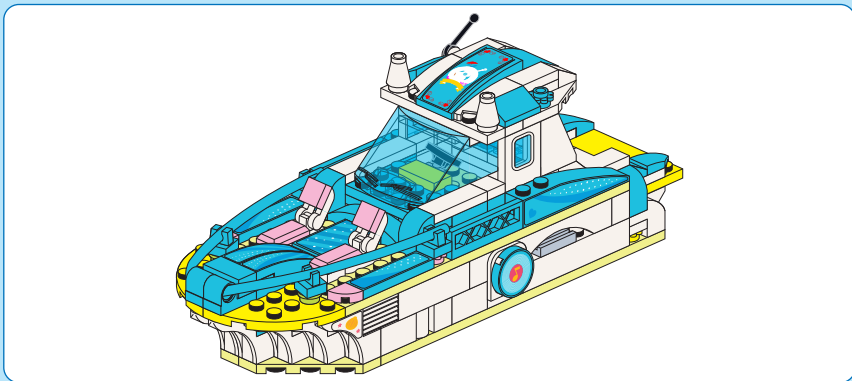

E1

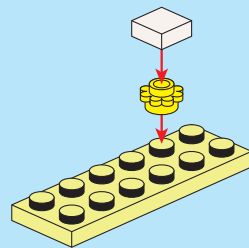
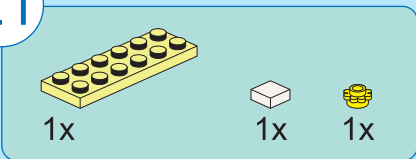

E2

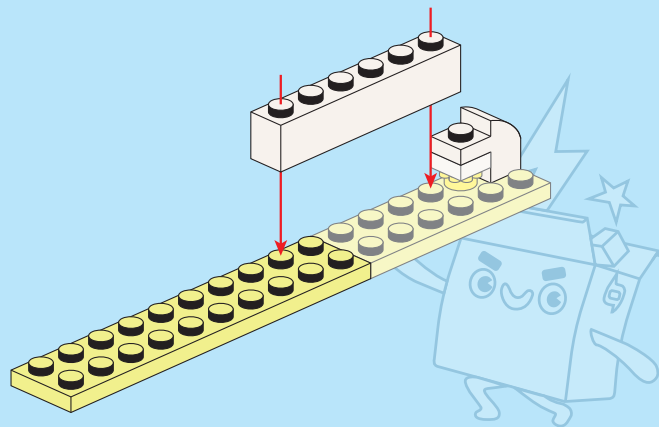
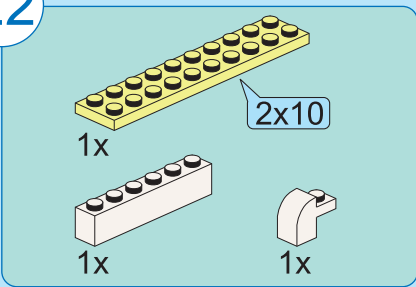

E3

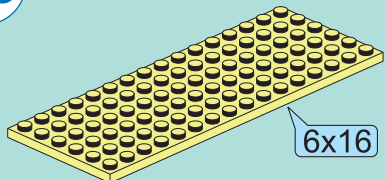

6x16

1x



2x



1x

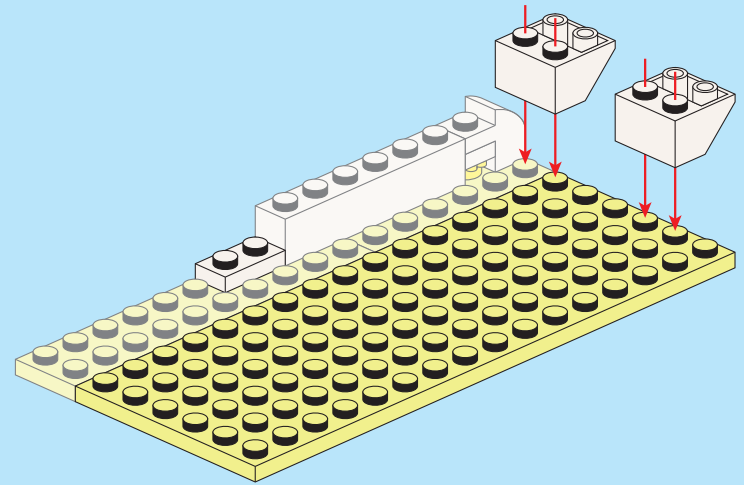

E4

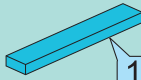

2x

1x6



1x



1x



1x



1x

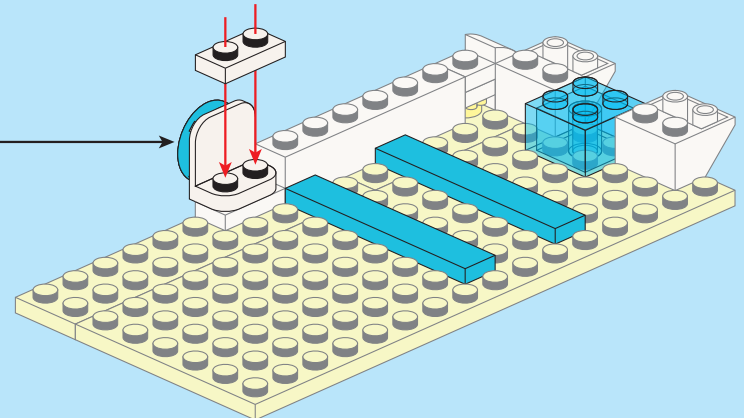
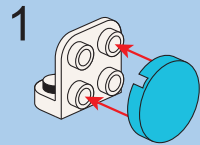

E5

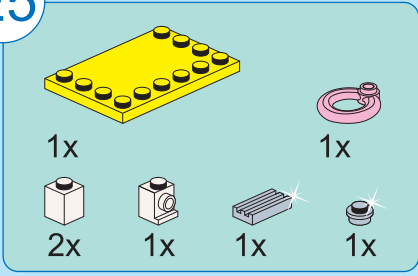

1x Yellow 1x6 Technic Plate
1x White 1x1 Technic Brick with Hole
1x White 1x2 Technic Brick with Hole
1x White 1x3 Technic Brick with Hole
1x White 1x1 Technic Brick with Hole
1x Pink Ring

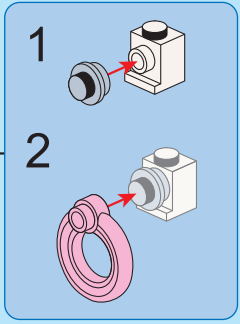

1. White 1x1 Technic Brick with Hole being inserted into a hole in the yellow plate.
2. Pink Ring being inserted into the hole of the white 1x1 Technic Brick with Hole.

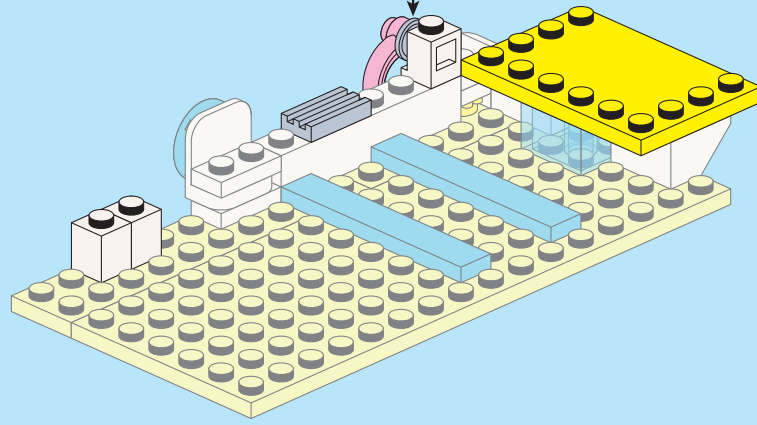

E6

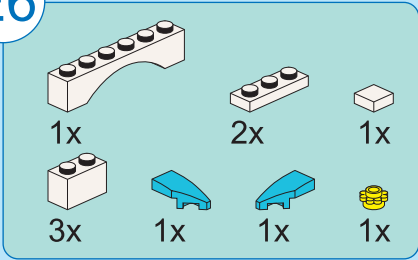

1x White 1x6 Technic Arch
2x White 1x3 Technic Brick with Hole
1x White 1x1 Technic Brick with Hole
3x White 1x1 Technic Brick with Hole
1x Blue Technic Piece
1x Blue Technic Piece
1x Yellow Technic Piece

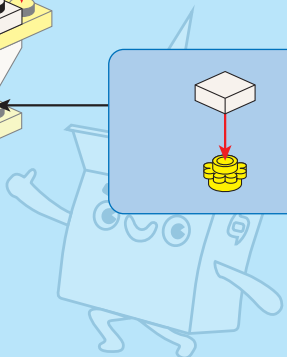
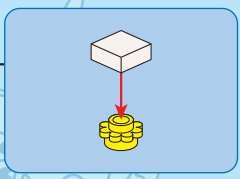
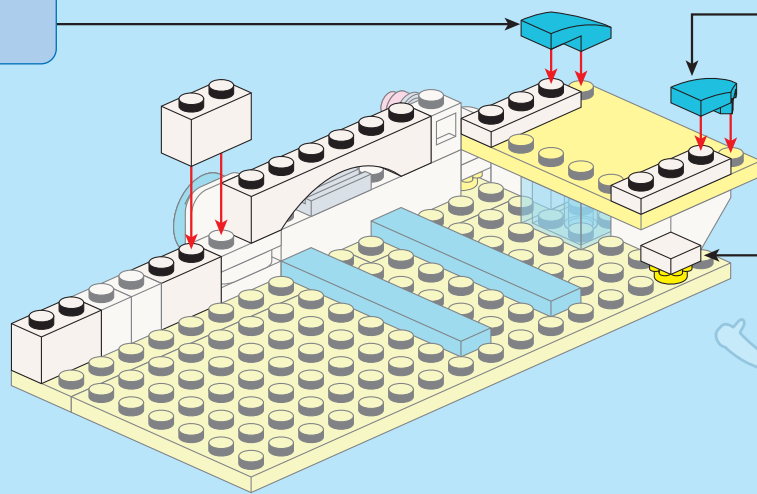
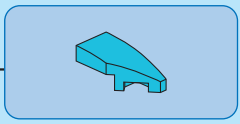
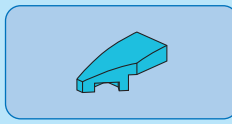

E7

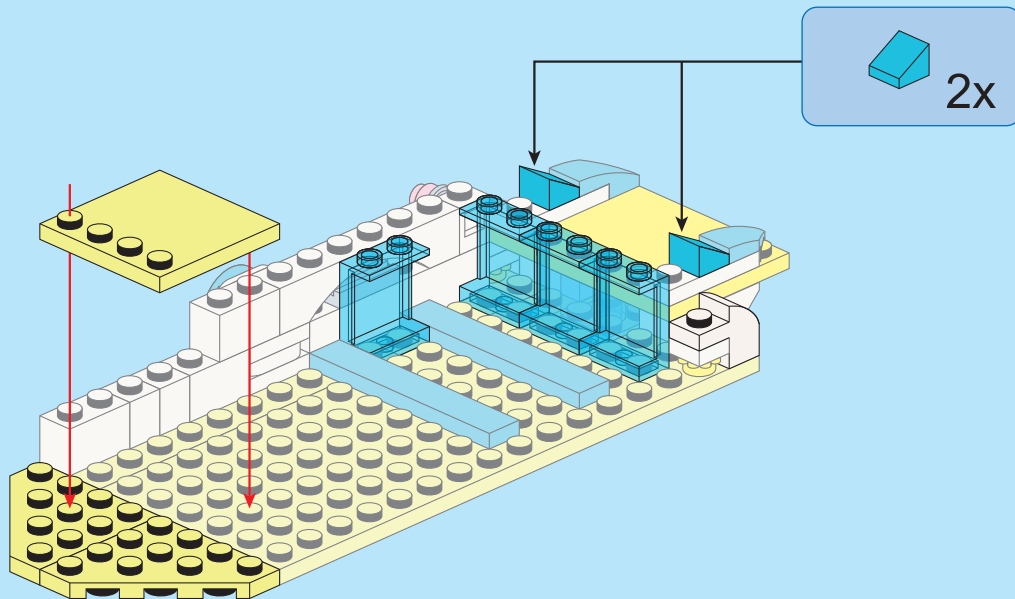
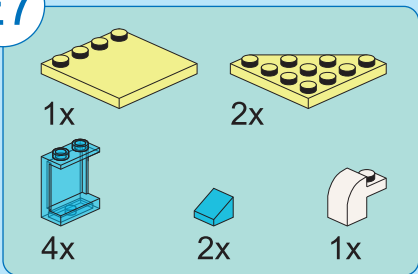

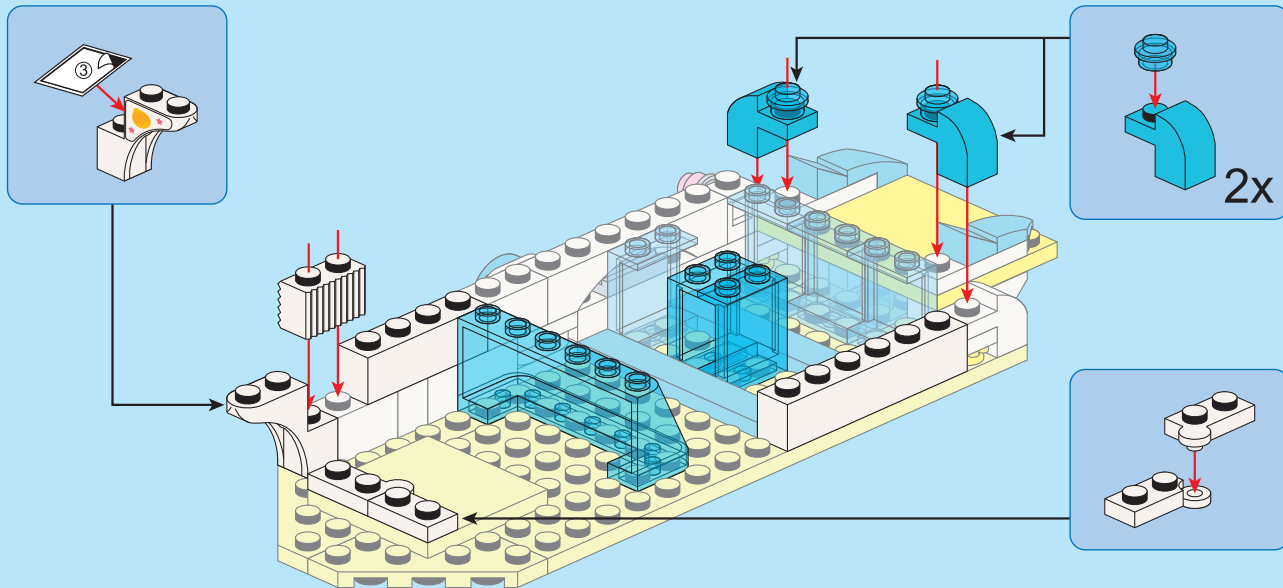
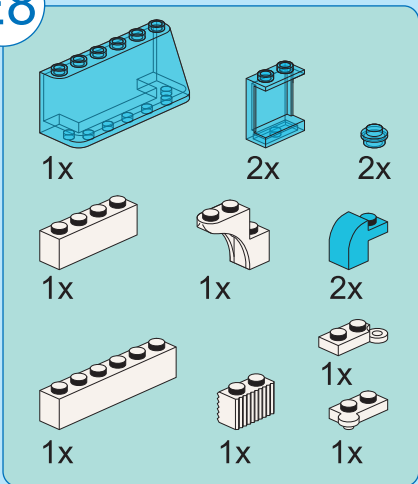

E8



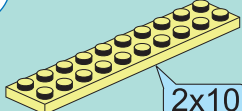



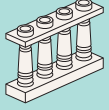

E9

1x  2x10

1x 

1x  1x  1x 

1x  1x  2x 

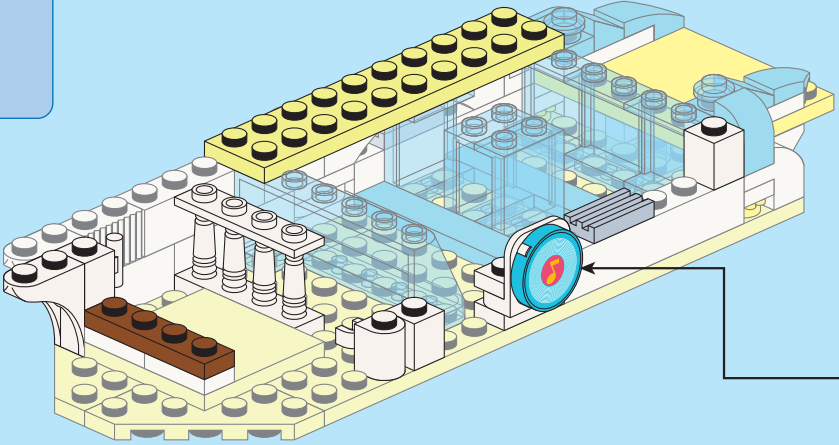
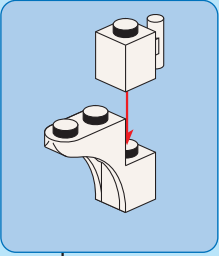

1x  1x  2x 

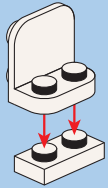
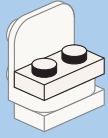
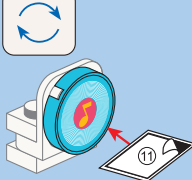

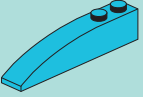
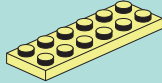

- 
- 
- 

E10

1x  1x 

1x  2x 

2x  2x 

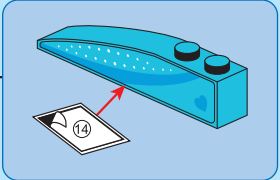
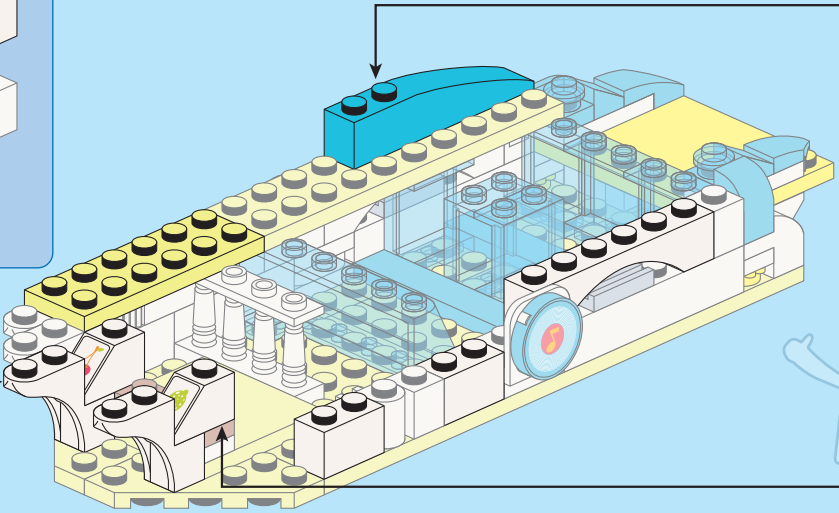
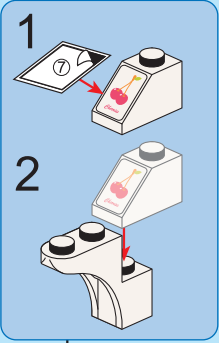

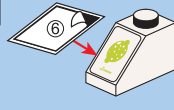
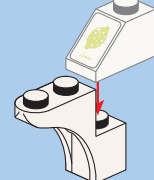
- 
- 

E11

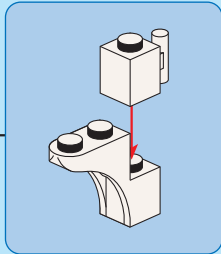
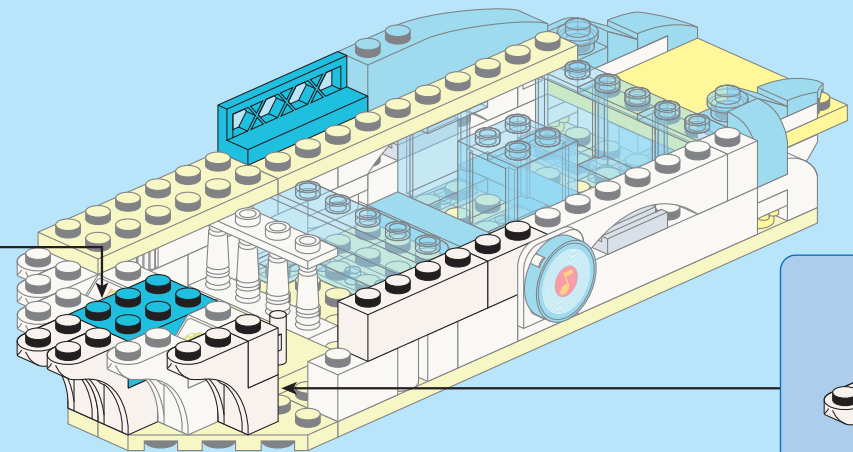
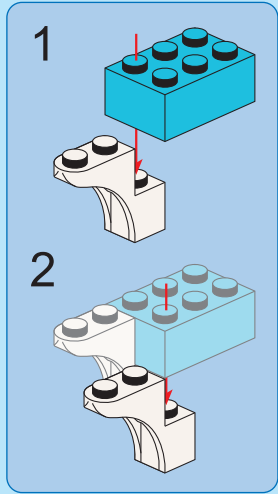
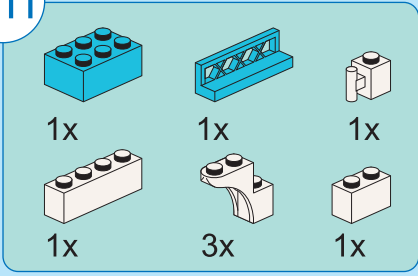

E12

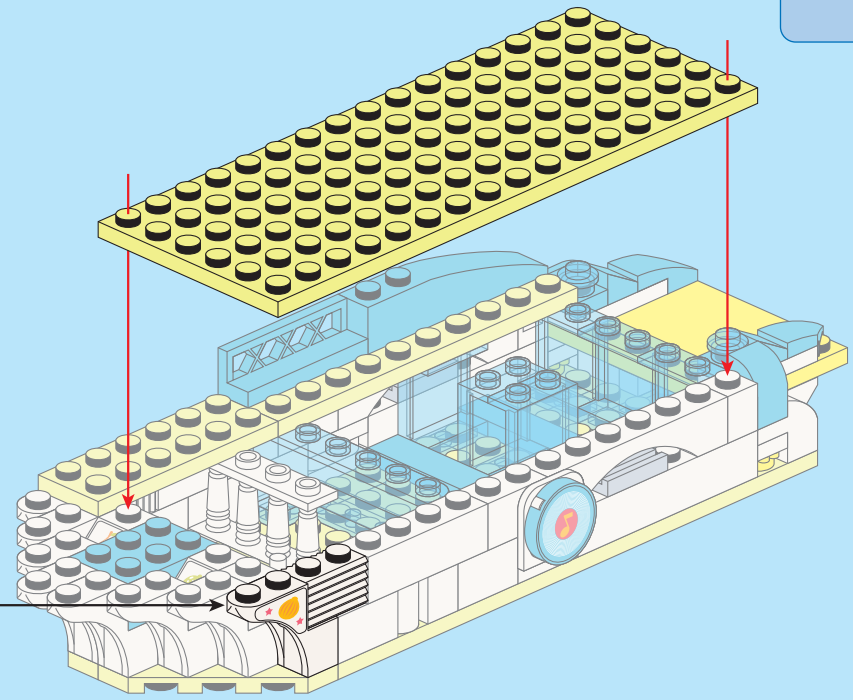
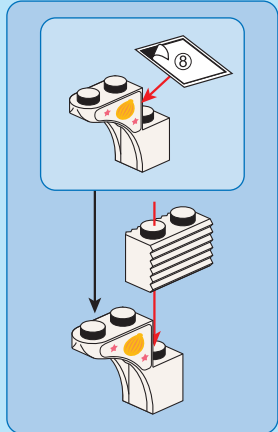
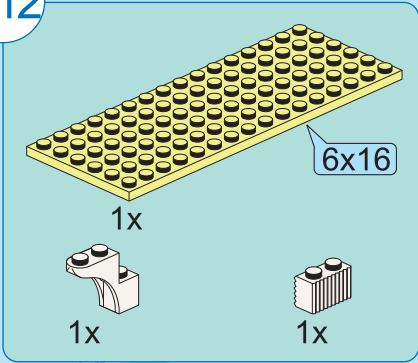

E13

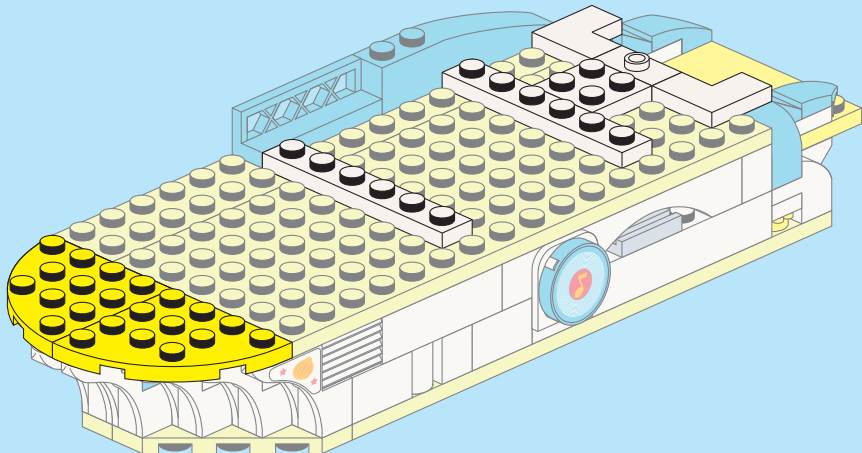
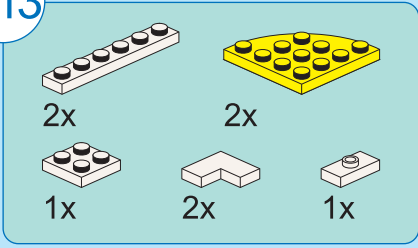

E14

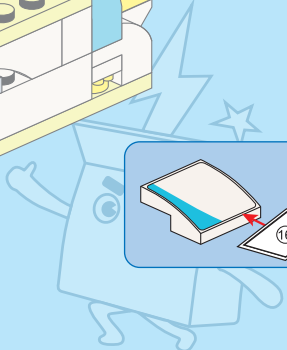
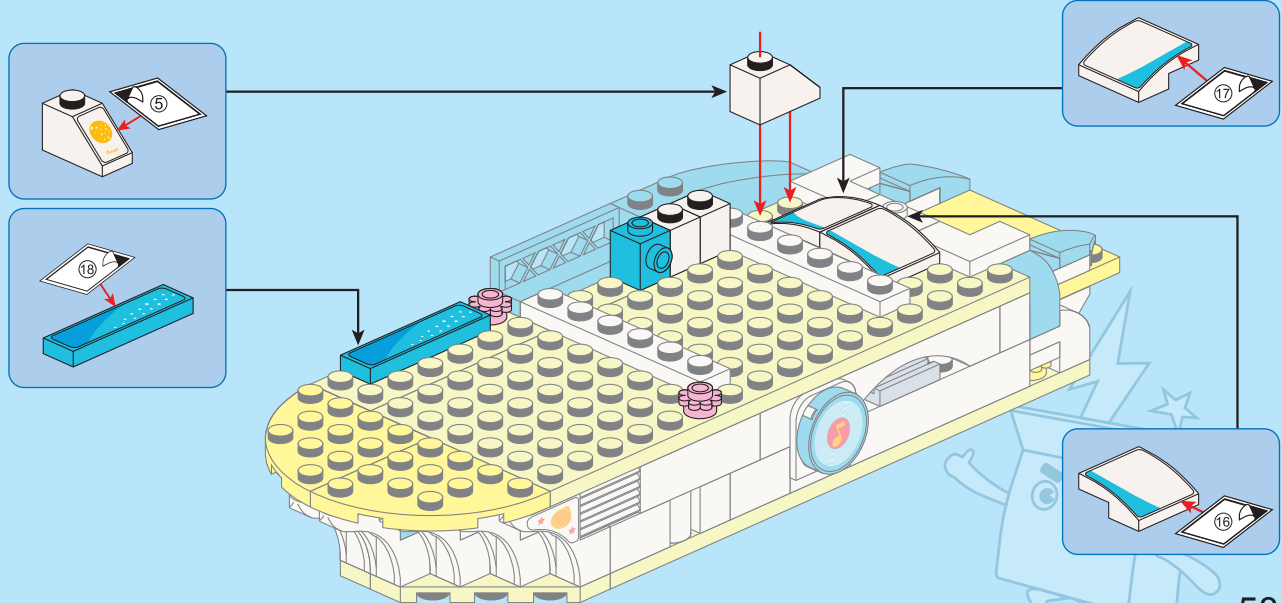
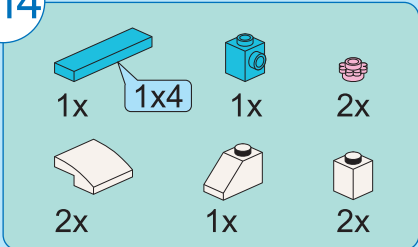

E15

1x (white 1x6 Technic beam)
 2x (white 1x3 Technic beam)
 2x (white 1x1 with hole Technic brick)
 1x (blue 1x4 Technic plate)
 1x (white 1x2 Technic brick with hole)
 2x (white 1x1 Technic brick)
 1x (blue 1x1 Technic brick)
 2x (white 1x2 Technic brick with hole)
 1x (blue 1x2 Technic plate)
 1x (grey 1x1 Technic brick with hole)
 1x (black 1x1 Technic pin)

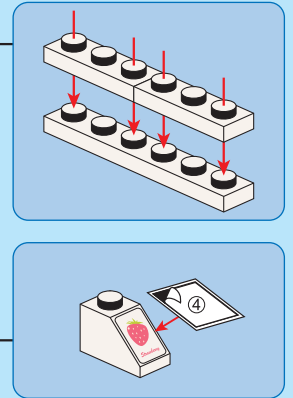
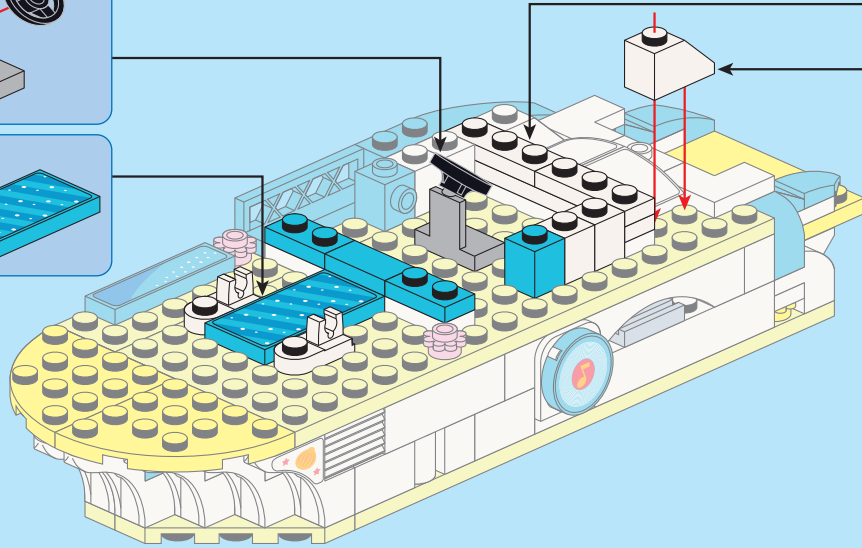
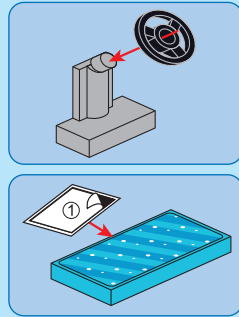





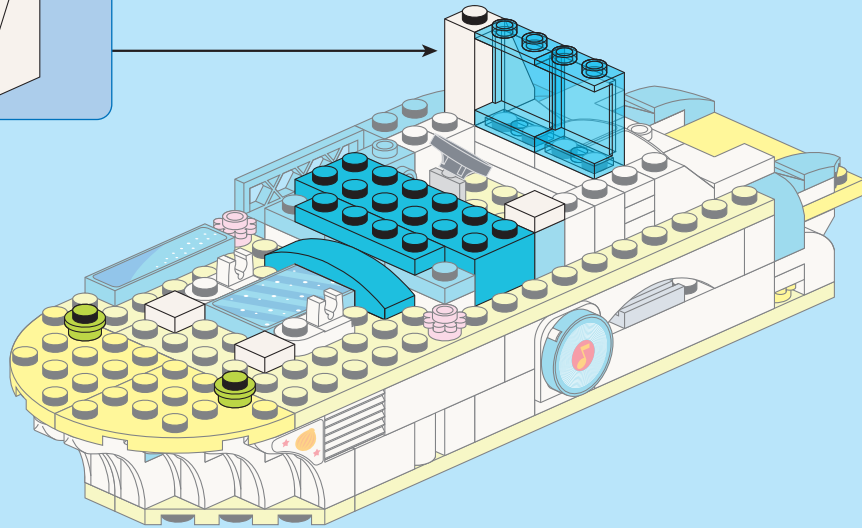
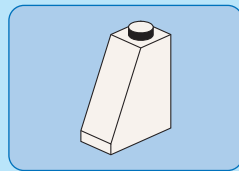

E16

1x (blue 1x6 Technic beam)
 2x (blue 1x2 Technic beam with hole)
 1x (white 1x2 Technic brick with hole)
 1x (blue 1x2 Technic curved plate)
 1x (blue 1x4 Technic beam with hole)
 2x (yellow 1x1 Technic pin)
 3x (white 1x1 Technic brick)







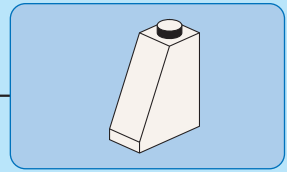
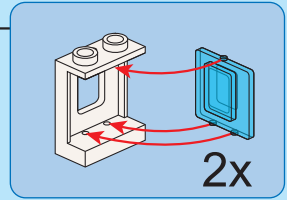
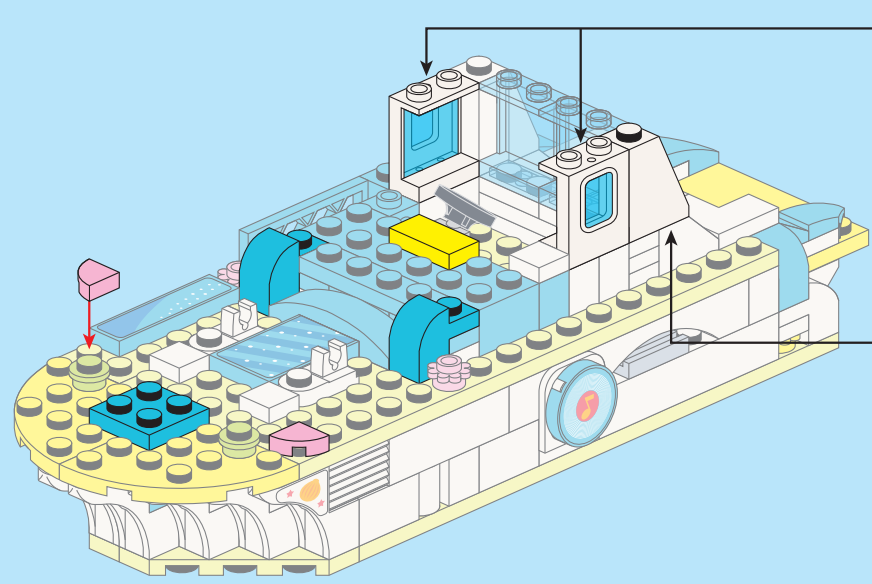

E17

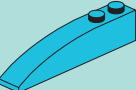
- 1x 
- 2x 
- 1x 
- 2x 
- 2x 
- 1x 
- 2x 



E18

- 1x 
- 1x  1x4
- 1x 
- 2x 
- 2x 
- 1x  1x4
- 1x  1x3

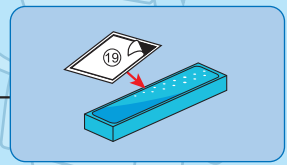
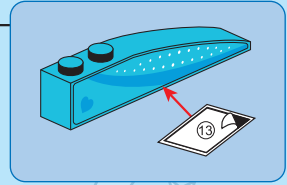
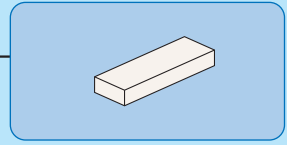
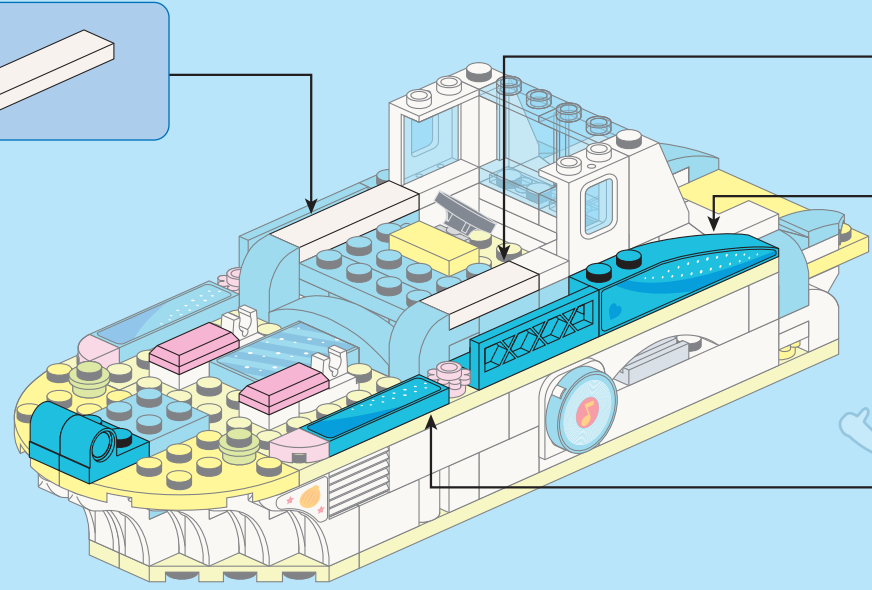
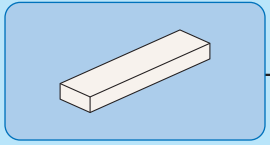

E19

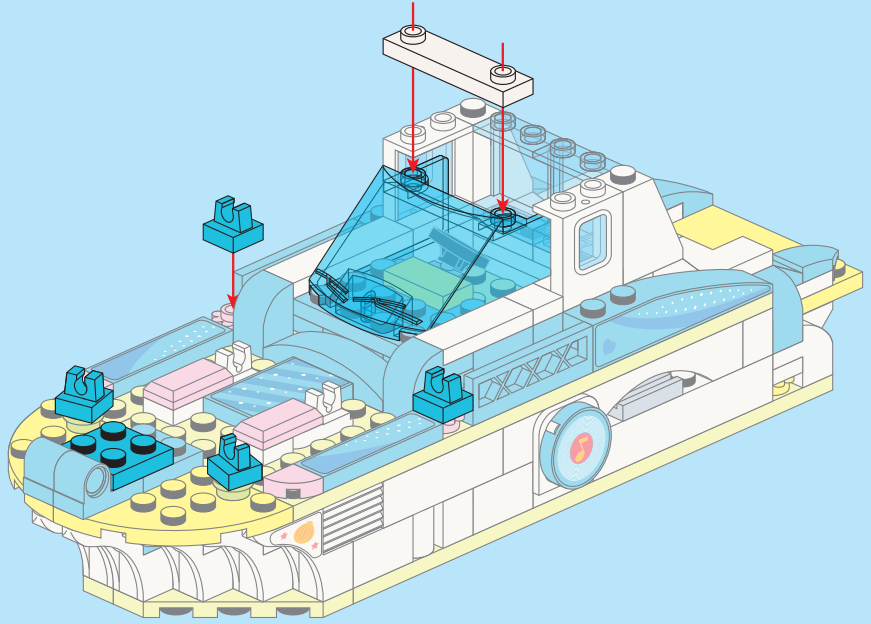
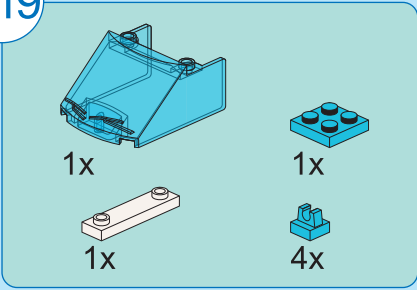

E20

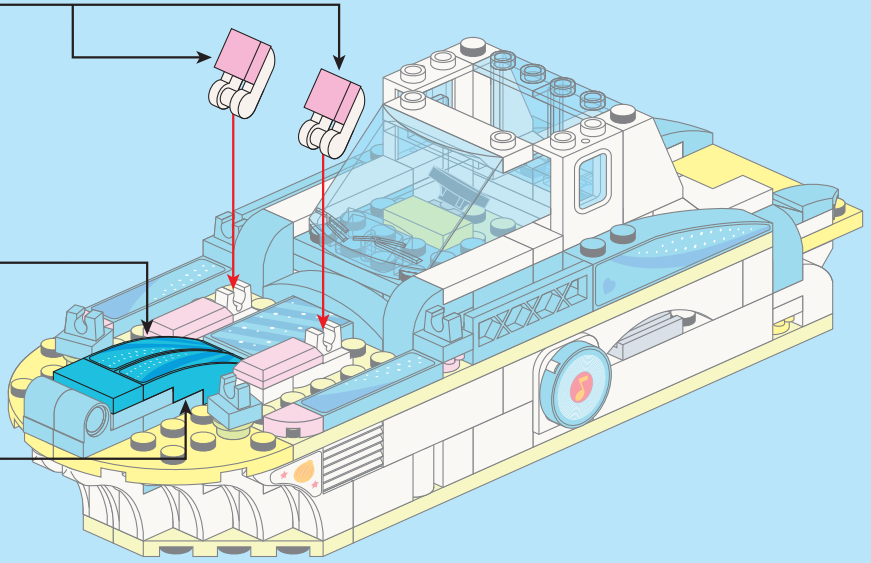
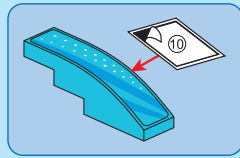
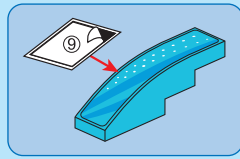
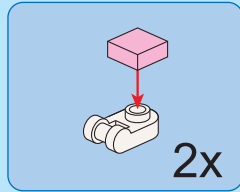
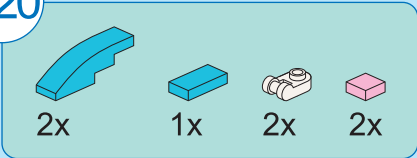

E21

1x

1x

2x

1x

1x

2x

2x

1x

1x

2x

1x

2x

2x

1x

1x

1x

1x

1x

1x

1x

1x

90mm

1

2

3

4

5

6

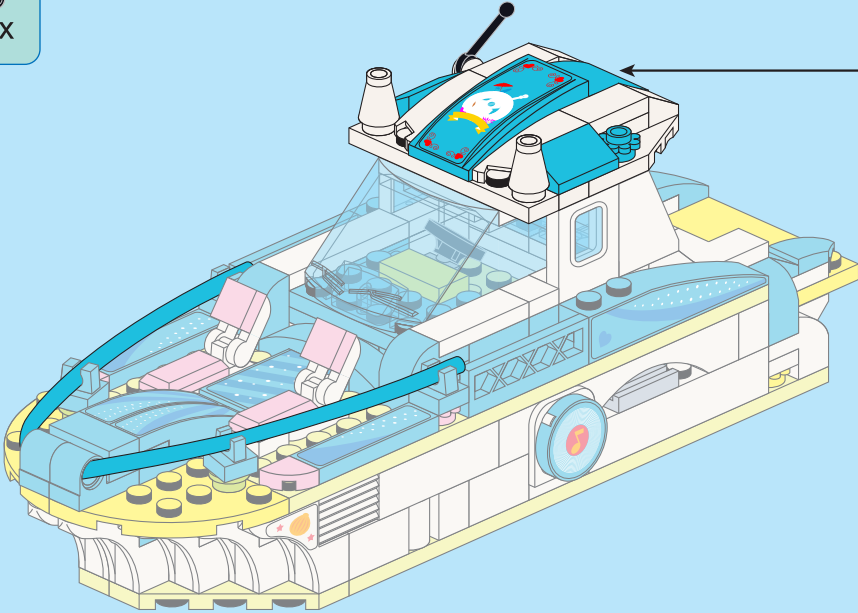



UNLIMITED IDEAS

WS4804



© 2015 The LEGO Group. All rights reserved. LEGO, the LEGO logo, and the Brick and Knob configurations are registered trademarks of The LEGO Group. All other trademarks are the property of their respective owners.